

GloTek, Inc. www.globtek.com 186 Veterans Drive, Northvale, NJ 07647 Tel. (201) 784-1000 Fax (201) 784-0111	Drawing Title: Australia AS/NZS 3112 without ground pin (Type I) to IEC320/C17, GT Cable #423: 1.0mmsq / 2 Conductors, 6.7mm OD, H05VV-F, 70 Deg.C, 500V, BLU/BRN, Approvals: VDE, S, N, FI, IMQ, KEMA, SEV, SAA, IEC 60227, 2000mm, GlobTek Black
	Model No. Power Cord
Part No./Ordering No. 5014112M071A(R)	Rev B

CUSTOMIZED LENGTHS, COLORS, CABLE TYPES, TERMINATIONS/PLUGS/RECEPTACLES AVAILABLE UPON REQUEST. ADDITIONAL PLUG OPTIONS ARE AVAILABLE AT <https://www.globtek.com/connectors/> STANDARD PLUGS AND CONNECTORS CAN BE SEEN ONLINE AT <https://www.globtek.com/connectors/> ACTUAL CONNECTORS, OVERMOLDS, FERRITES MAY VARY SLIGHTLY FROM THE PICTURE BELOW DIMENSIONS ARE IN MM UNLESS SPECIFIED OTHERWISE

In Addition to GlobTek Inc.'s renewed ISO9001:2008 - Quality Management System Certification, GlobTek Inc. is now certified to:

- ISO13485:2003 - Medical Devices Quality Management System Certification
- ISO14001:2004 - Environmental Management System Certification

ISO Certificates are available online at <https://www.globtek.com/iso-certificates/>
Prop 65 Statement: <https://en.globtek.com/prop-65-statement.pdf>

The acceptance of this specification and use of the product described in this document indicates the acceptance and binding of the customer to Globtek TERMS AND CONDITIONS (attached to the end of this document), which supersede all other agreements, terms, and conditions (<https://en.globtek.com/terms-and-conditions/>).

The purchaser of this product (Customer) agrees that it is their sole responsibility to determine suitability/fitness of the product described in this specification for their application and to take precautions for protection against any hazards attendant to the handling and use of the product.

Footnote:

GlobTek Inc. will not be liable for the safety and performance of these power supplies if unauthorized access and repair occurs. End user should consult applicable UL, CSA or EN standards for proper installation instruction.

Limitation of Use:

GlobTek products are intended for use with commercial, medical, and/or industrial equipment only. GlobTek product are not authorized for use as mission critical components in life support hazardous environment, nuclear or aircraft applications without prior written approval from the CEO of GlobTek Inc.
Contents of this document are subject to change without prior notice.

Customer Approval of Specification:

Please approve, sign and send back to GlobTek so we can complete order processing.
A delay in receipt of this form will delay delivery schedule.

Company Name: _____	Customer P/N: _____
Quote Number: _____	Date: _____
Authorized Representative Name: _____	Authorized Representative Signature: _____

GlobTek, Inc. www.globtek.com 186 Veterans Drive, Northvale, NJ 07647 Tel. (201) 784-1000 Fax (201) 784-0111	Drawing Title: Australia AS/NZS 3112 without ground pin (Type I) to IEC320/C17, GT Cable #423: 1.0mmsq / 2 Conductors, 6.7mm OD, H05VV-F, 70 Deg.C, 500V, BLU/BRN, Approvals: VDE, S, N, FI, IMQ, KEMA, SEV, SAA, IEC 60227, 2000mm, GlobTek Black	
	Model No. Power Cord	
	Part No./Ordering No. 5014112M071A(R)	Rev B

CUSTOMIZED LENGTHS, COLORS, CABLE TYPES, TERMINATIONS/PLUGS/RECEPTACLES AVAILABLE UPON REQUEST. ADDITIONAL PLUG OPTIONS ARE AVAILABLE AT <https://www.globtek.com/connectors/> STANDARD PLUGS AND CONNECTORS CAN BE SEEN ONLINE AT <https://www.globtek.com/connectors/> ACTUAL CONNECTORS, OVERMOLDS, FERRITES MAY VARY SLIGHTLY FROM THE PICTURE BELOW DIMENSIONS ARE IN MM UNLESS SPECIFIED OTHERWISE

REVISION HISTORY

REV	DESCRIPTION	SUB	DATE	APPROVED
B	Revise connector approval from SAA to ENEC-VDE; Add cordset drawing to spec; Add C-Tick to plug approval.	bsiep	12/23/2019	QA
A	Initial Release	bsiep	03/22/2019	QA

Cordset Information:

CordsetColor:GlobTek Black

Cord Length (mm):2000

NOTES:

Cord, Plug and Connector must be marked with approval symbols of file number(s)

GlobTek, Inc. www.globtek.com 186 Veterans Drive, Northvale, NJ 07647 Tel. (201) 784-1000 Fax (201) 784-0111	Drawing Title: Australia AS/NZS 3112 without ground pin (Type I) to IEC320/C17, GT Cable #423: 1.0mmsq / 2 Conductors, 6.7mm OD, H05VV-F, 70 Deg.C, 500V, BLU/BRN, Approvals: VDE, S, N, FI, IMQ, KEMA, SEV, SAA, IEC 60227, 2000mm, GlobTek Black
	Model No. Power Cord
Part No./Ordering No. 5014112M071A(R)	Rev B

CUSTOMIZED LENGTHS, COLORS, CABLE TYPES, TERMINATIONS/PLUGS/RECEPTACLES AVAILABLE UPON REQUEST. ADDITIONAL PLUG OPTIONS ARE AVAILABLE AT <https://www.globtek.com/connectors/> STANDARD PLUGS AND CONNECTORS CAN BE SEEN ONLINE AT <https://www.globtek.com/connectors/> ACTUAL CONNECTORS, OVERMOLDS, FERRITES MAY VARY SLIGHTLY FROM THE PICTURE BELOW DIMENSIONS ARE IN MM UNLESS SPECIFIED OTHERWISE

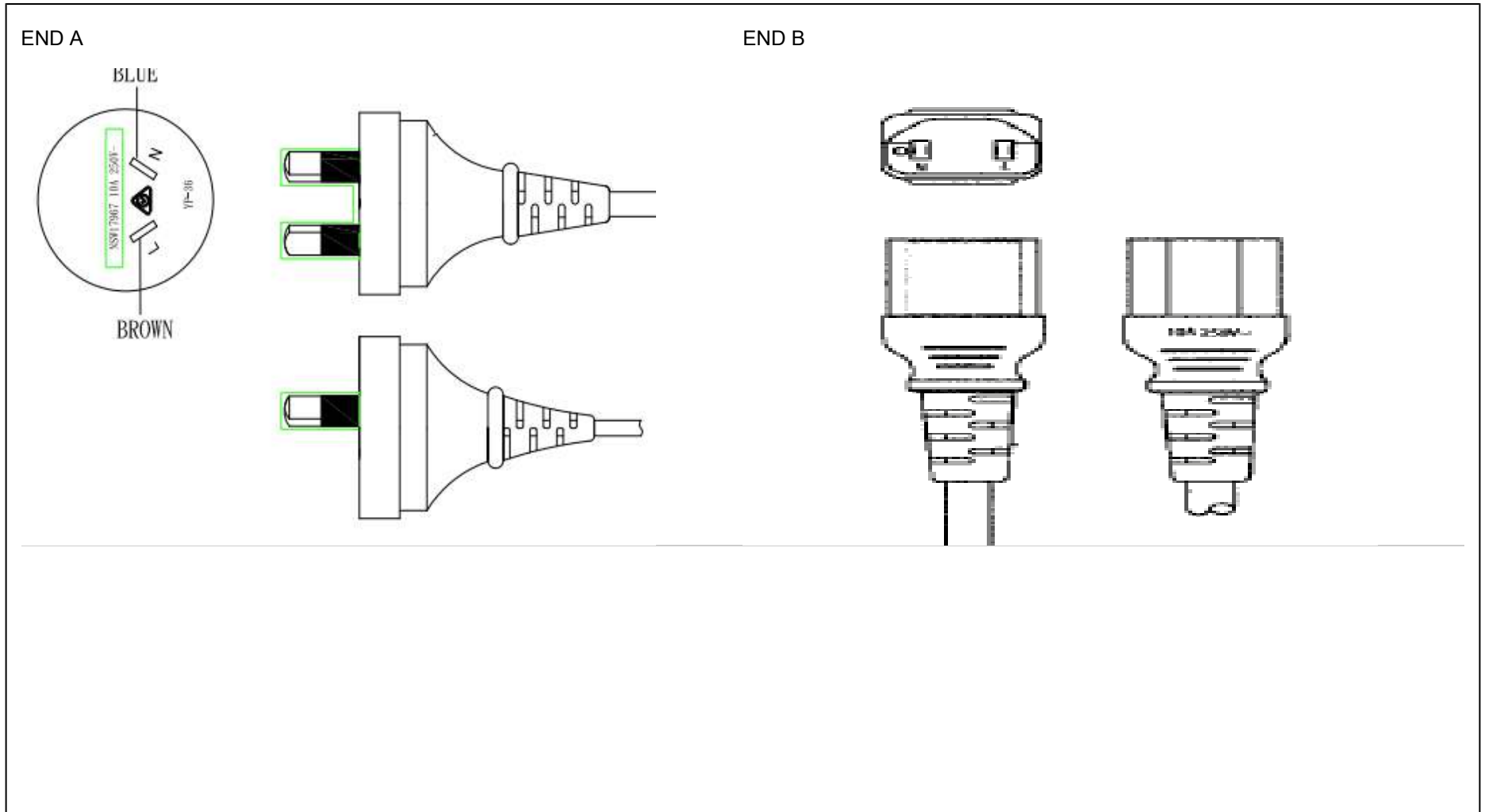

PROPRIETARY INFORMATION

PROPRIETARY OF GLOBTEK, INC. ANY REPRODUCTION, DISCLOSURE OR USE OF THIS DRAWING, IN WHOLE OR IN PART, IS HEREBY PROHIBITED EXCEPT AS SPECIFIED IN WRITING BY GLOBTEK, INC. © GlobTek, Inc. 2019 - 2023

quest /10/08/2023 12:20:47 PM CLONED FROM 209A4062M071(R)

GlobTek, Inc. www.globtek.com 186 Veterans Drive, Northvale, NJ 07647 Tel. (201) 784-1000 Fax (201) 784-0111	Drawing Title: Australia AS/NZS 3112 without ground pin (Type I) to IEC320/C17, GT Cable #423: 1.0mmsq / 2 Conductors, 6.7mm OD, H05VV-F, 70 Deg.C, 500V, BLU/BRN, Approvals: VDE, S, N, FI, IMQ, KEMA, SEV, SAA, IEC 60227, 2000mm, GlobTek Black
	Model No. Power Cord
Part No./Ordering No. 5014112M071A(R)	Rev B

CUSTOMIZED LENGTHS, COLORS, CABLE TYPES, TERMINATIONS/PLUGS/RECEPTACLES AVAILABLE UPON REQUEST. ADDITIONAL PLUG OPTIONS ARE AVAILABLE AT <https://www.globtek.com/connectors/> STANDARD PLUGS AND CONNECTORS CAN BE SEEN ONLINE AT <https://www.globtek.com/connectors/> ACTUAL CONNECTORS, OVERMOLDS, FERRITES MAY VARY SLIGHTLY FROM THE PICTURE BELOW DIMENSIONS ARE IN MM UNLESS SPECIFIED OTHERWISE

CABLE IMAGE

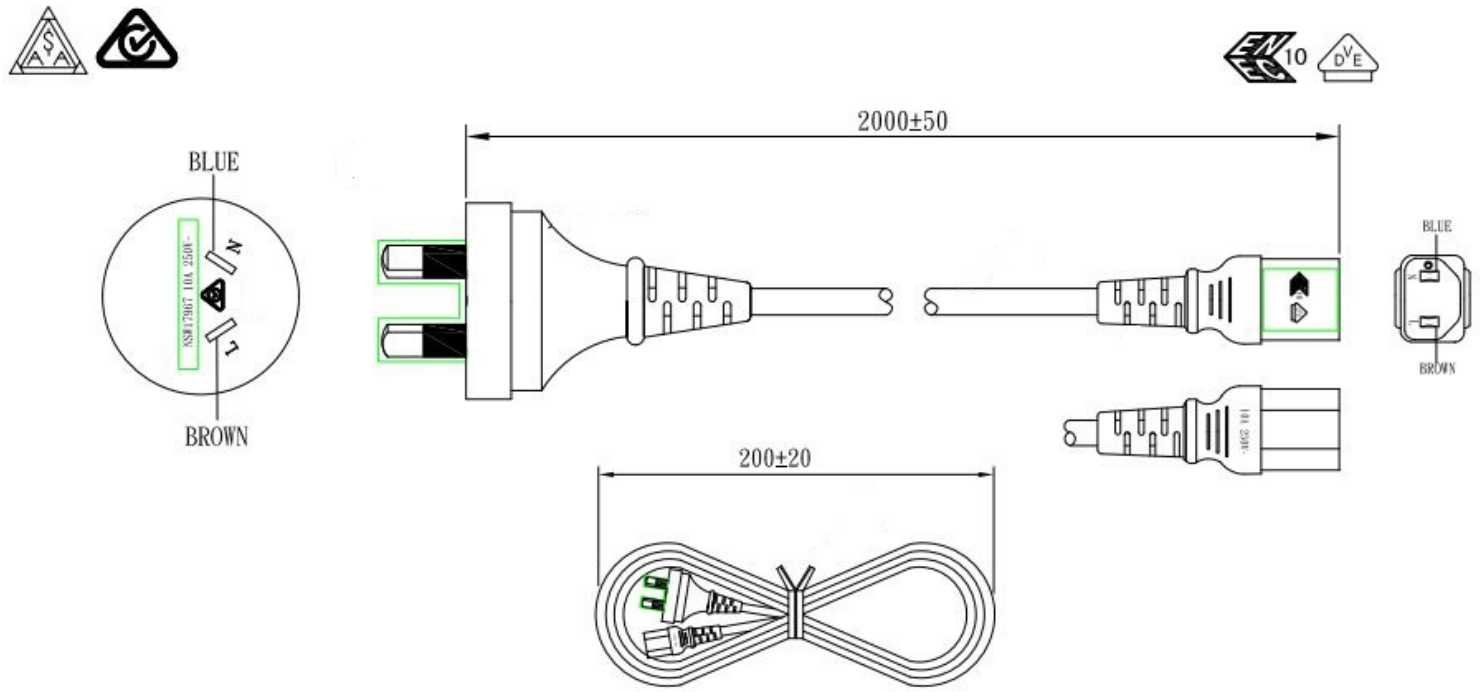





GlobTek, Inc. www.globtek.com 186 Veterans Drive, Northvale, NJ 07647 Tel. (201) 784-1000 Fax (201) 784-0111	Drawing Title: Australia AS/NZS 3112 without ground pin (Type I) to IEC320/C17, GT Cable #423: 1.0mmsq / 2 Conductors, 6.7mm OD, H05VV-F, 70 Deg.C, 500V, BLU/BRN, Approvals: VDE, S, N, FI, IMQ, KEMA, SEV, SAA, IEC 60227, 2000mm, GlobTek Black	
	Model No. Power Cord	Part No./Ordering No. 5014112M071A(R)
		Rev B

CUSTOMIZED LENGTHS, COLORS, CABLE TYPES, TERMINATIONS/PLUGS/RECEPTACLES AVAILABLE UPON REQUEST. ADDITIONAL PLUG OPTIONS ARE AVAILABLE AT <https://www.globtek.com/connectors/> STANDARD PLUGS AND CONNECTORS CAN BE SEEN ONLINE AT <https://www.globtek.com/connectors/> ACTUAL CONNECTORS, OVERMOLDS, FERRITES MAY VARY SLIGHTLY FROM THE PICTURE BELOW DIMENSIONS ARE IN MM UNLESS SPECIFIED OTHERWISE

End A Code:501 Description:Australia AS/NZS 3112 without ground pin (Type I) Rating (V):250 Rating (A):10.0 Gender:Male Overmolded:Yes	Cable Code:423 Description:GT Cable #423: 1.0mmsq / 2 Conductors, 6.7mm OD, H05VV-F, 70 Deg.C, 500V, BLU/BRN, Approvals: VDE, S, N, FI, IMQ, KEMA, SEV, SAA, IEC 60227 Color:GlobTek Black Wire Gauge(AWG):1.0mmsq Cond:2 Type:H05VV-F Temperature:70° C Amps:10 Volts:500 OD:6.7 ConductorsColors:BLU/BRN	End B Code:071A-SAA Description:IEC320/C17 Rating (V):250 Rating (A):10.0 Gender:Female Overmolded:Yes
----------------------------------------------------------------------------------------------------------------------------------------------------------	---------------------------------------------------------------------------------------------------------------------------------------------------------------------------------------------------------------------------------------------------------------------------------------------------------------------------------------------	--------------------------------------------------------------------------------------------------------------------------

Overall cable rating:

Plug Approvals	Cable Approvals	Connector Approvals
----------------	-----------------	---------------------

		
Note: SAA may be indicated by a file number in the format Nxxxxxx	Note: SAA may be indicated by a file number in the format Nxxxxxx	ENEC-VDE
SAA+RCM	SAA+RCM	
		Euro + SAA

AGENCY ONLINE DOCUMENTS	http://en.globtek.com/cordsets/
RoHS/RoHS3 Declaration	https://www.globtek.com/pdf/rohs_cert/01t0c000008w7SGAAY
REACH Declaration	https://www.globtek.com/pdf/iso_certificates/REACH.pdf
Conflict Minerals Declaration	https://www.globtek.com/pdf/conflict-minerals.pdf

PROPRIETARY INFORMATION

PROPRIETARY OF GLOBTEK, INC. ANY REPRODUCTION, DISCLOSURE OR USE OF THIS DRAWING, IN WHOLE OR IN PART, IS HEREBY PROHIBITED EXCEPT AS SPECIFIED IN WRITING BY GLOBTEK, INC. © GlobTek, Inc. 2019 - 2023

quest /10/08/2023 12:20:47 PM CLONED FROM 209A4062M071(R)

GlobTek, Inc. www.globtek.com 186 Veterans Drive, Northvale, NJ 07647 Tel. (201) 784-1000 Fax (201) 784-0111	Drawing Title: Australia AS/NZS 3112 without ground pin (Type I) to IEC320/C17, GT Cable #423: 1.0mmsq / 2 Conductors, 6.7mm OD, H05VV-F, 70 Deg.C, 500V, BLU/BRN, Approvals: VDE, S, N, FI, IMQ, KEMA, SEV, SAA, IEC 60227, 2000mm, GlobTek Black	
	Model No. Power Cord	
Part No./Ordering No. 5014112M071A(R)		Rev B

CUSTOMIZED LENGTHS, COLORS, CABLE TYPES, TERMINATIONS/PLUGS/RECEPTACLES AVAILABLE UPON REQUEST. ADDITIONAL PLUG OPTIONS ARE AVAILABLE AT <https://www.globtek.com/connectors/> STANDARD PLUGS AND CONNECTORS CAN BE SEEN ONLINE AT <https://www.globtek.com/connectors/> ACTUAL CONNECTORS, OVERMOLDS, FERRITES MAY VARY SLIGHTLY FROM THE PICTURE BELOW DIMENSIONS ARE IN MM UNLESS SPECIFIED OTHERWISE

Prop 65 Statement	https://en.globtek.com/prop-65-statement.pdf
CE.UKCA.Cord	https://globtek.secure.force.com/spec/ec_decl_product_model_family_incl_cord?id=01t0c000008w7SG
IPXY rating is based on 3rd party testing and customers should check suitability and test system level IPXY rating before ordering.	

PROPRIETARY INFORMATION

PROPRIETARY OF GLOBTEK, INC. ANY REPRODUCTION, DISCLOSURE OR USE OF THIS DRAWING, IN WHOLE OR IN PART, IS HEREBY PROHIBITED EXCEPT AS SPECIFIED IN WRITING BY GLOBTEK, INC. © GlobTek, Inc. 2019 - 2023

quest /10/08/2023 12:20:47 PM CLONED FROM 209A4062M071(R)

GlobTek, Inc. www.globtek.com 186 Veterans Drive, Northvale, NJ 07647 Tel. (201) 784-1000 Fax (201) 784-0111	Drawing Title: Australia AS/NZS 3112 without ground pin (Type I) to IEC320/C17, GT Cable #423: 1.0mmsq / 2 Conductors, 6.7mm OD, H05VV-F, 70 Deg.C, 500V, BLU/BRN, Approvals: VDE, S, N, FI, IMQ, KEMA, SEV, SAA, IEC 60227, 2000mm, GlobTek Black	
	Model No. Power Cord	
	Part No./Ordering No. 5014112M071A(R)	Rev B

CUSTOMIZED LENGTHS, COLORS, CABLE TYPES, TERMINATIONS/PLUGS/RECEPTACLES AVAILABLE UPON REQUEST. ADDITIONAL PLUG OPTIONS ARE AVAILABLE AT <https://www.globtek.com/connectors/> STANDARD PLUGS AND CONNECTORS CAN BE SEEN ONLINE AT <https://www.globtek.com/connectors/> ACTUAL CONNECTORS, OVERMOLDS, FERRITES MAY VARY SLIGHTLY FROM THE PICTURE BELOW DIMENSIONS ARE IN MM UNLESS SPECIFIED OTHERWISE

Hanking:200
Description:200 +/- 20mm
Image:

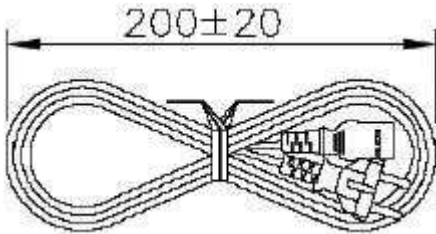

Notes/Modifications/Customizations (notes in this section supersede the values shown in the standard spec):