

XT132B1FAL2

Telemecanique Capacitive proximity sensors
XT, cylindrical Ø 32 mm, brass, Sn 15 mm,
cable 2 m



Main

Range of Product	Telemecanique Capacitive proximity sensors XT
Sensor Type	Capacitive proximity sensor
Product Specific Application	Detection of insulated or conductive materials
Sensor name	XT1
Sensor design	Cylindrical Ø 32 mm plain
Size	80 mm
Body type	Fixed
Detector flush mounting acceptance	Flush mountable
Material	Metal
Enclosure Material	Nickel Plated Brass
Type of output signal	Discrete
Wiring Technique	2-wire
[Sn] nominal sensing distance	0.59 in (15 mm)
Discrete output function	1 NO
Output circuit type	AC
Electrical connection	Cable
Cable length	6.56 ft (2 m)
[Us] rated supply voltage	24...240 V AC 50...60 Hz
Maximum delay response	30 ms
IP degree of protection	IP67 conforming to IEC 60529 IP67 conforming to IEC 60947-5-2

Complementary

Detection face	Frontal
[Sa] assured operating distance	0.00...0.43 in (0...11 mm)
Adjustment zone	0.00...0.79 in (0...20 mm)
Differential travel	< 0.2 x Sr
Repeat accuracy	< 0.15 x Sr
Wire insulation material	PVC
Status LED	Output state indication 1 LED yellow)
Supply voltage limits	20...264 V AC
Maximum residual current	5 mA open state
Switching frequency	<= 15 Hz
Maximum voltage drop	<10 V closed)
Current consumption	< 4 mA
Maximum delay first up	200 ms
Maximum delay recovery	30 ms
Maximum switching current	300 mA
Marking	CE
Setting-up	Sensitivity by potentiometer
Length	3.15 in (80 mm)
Net Weight	0.88 lb(US) (0.4 kg)

The information provided in this documentation contains general descriptions and/or technical characteristics of the performance of the products contained herein. This documentation is not intended as a substitute for and is not to be used for determining suitability or reliability of these products for specific user applications. It is the duty of any such user or integrator to perform the appropriate and complete risk analysis, evaluation and testing of the products with respect to the relevant specific application or use thereof. Neither Schneider Electric Industries SAS nor any of its affiliates or subsidiaries shall be responsible or liable for misuse of the information contained herein.

Environment

Standards	EN/IEC 60947-5-2
Product Certifications	cULus
Ambient Air Temperature for Operation	-13...158 °F (-25...70 °C)
Vibration resistance	10 gn 1 mm 10...55 Hz)IEC 60068-2-6
Shock resistance	30 gn 11 ms IEC 60068-2-27
Resistance to electrostatic discharge	4 KV contact IEC 61000-4-2 8 kV air IEC 61000-4-2
Resistance to electromagnetic fields	2.74 V/m (3 V/m) IEC 61000-4-3
Resistance to fast transients	2 kV IEC 61000-4-4



Ordering and shipping details

Category	22486-SENSORS, PROXIMITY
Discount Schedule	DS2
GTIN	3389119025775
Nbr. of units in pkg.	1
Package weight(Lbs)	9.70 oz (275.0 g)
Returnability	No
Country of origin	CN

Packing Units

Unit Type of Package 1	PCE
Package 1 Height	1.77 in (4.5 cm)
Package 1 width	4.72 in (12 cm)
Package 1 Length	5.12 in (13 cm)
Unit Type of Package 2	S02
Number of Units in Package 2	25
Package 2 Weight	16.05 lb(US) (7.281 kg)
Package 2 Height	5.91 in (15 cm)
Package 2 width	11.81 in (30 cm)
Package 2 Length	15.75 in (40 cm)

Offer Sustainability

California proposition 65	WARNING: This product can expose you to chemicals including: Diisononyl phthalate (DINP), which is known to the State of California to cause cancer, and Di-isodecyl phthalate (DIDP), which is known to the State of California to cause birth defects or other reproductive harm. For more information go to www.P65Warnings.ca.gov
REACH Regulation	 REACH Declaration
REACH free of SVHC	Yes
EU RoHS Directive	Pro-active compliance (Product out of EU RoHS legal scope)  EU RoHS Declaration
Toxic heavy metal free	Yes
Mercury free	Yes
RoHS exemption information	 Yes

Contractual warranty

Warranty	18 months
----------	-----------

Dimensions

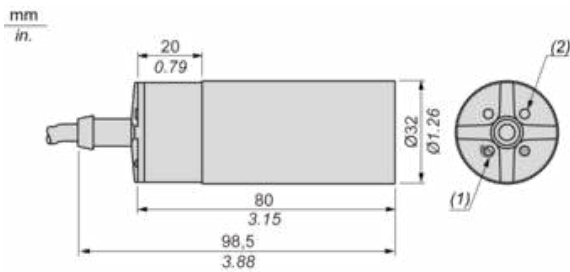

(1) Adjustment potentiometer

(2) LED

Mounting Accessory Included

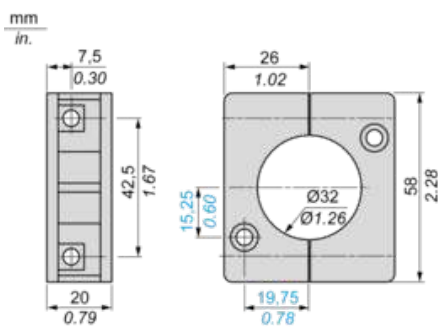

Mounting and Clearance

Minimum Mounting Distances

Side by side

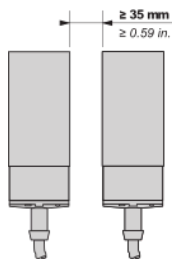

Face to face

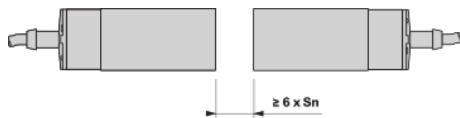

Facing a Metal Object

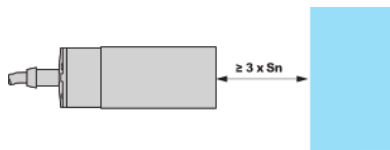

Connections and schema

Wiring diagram

2-wire AC, NO output, pre-cabled

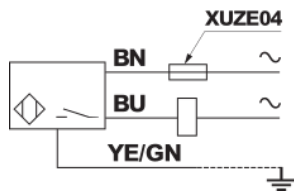

BN: Brown

BU: Blue

YE/GN: Yellow/Green