

FEMALE PLUG M12 STRAIGHT TO MALE PLUG M12 STRAIGHT



NOTES:

RATED VOLTAGE: 3, 4 contacts 250V per IEC 60664
 5 contacts 60V per IEC 60664
 5 contacts 250V per UL 2238
 8 contacts 30V per IEC 60664

RATED CURRENT: 3, 4, 5 contacts 4A
 8 contacts 2A

PROTECTION CLASS: IP 67
 TEMPERATURE: -25°C / +85°C

CONTACTS POSITION FRONT VIEW:

	3 CONTACTS		4 CONTACTS		5 CONTACTS		8 CONTACTS	
FEMALE								
MALE								
CONNECTIONS	PIN	WIRE	PIN	WIRE	PIN	WIRE	PIN	WIRE
	1	BROWN	1	BROWN	1	BROWN	1	WHITE
	2	-	2	WHITE	2	WHITE	2	BROWN
	3	BLUE	3	BLUE	3	BLUE	3	GREEN
	4	BLACK	4	BLACK	4	BLACK	4	YELLOW
					5	GREY	5	GREY
							6	PINK
							7	BLUE
						8	RED	

CODING REQUIRED TO IEC 61076-2-101

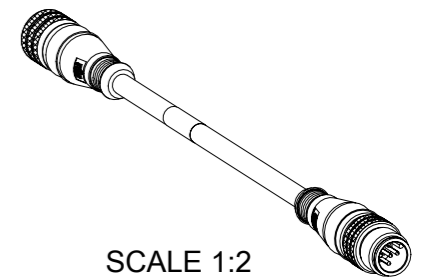

SCALE 1:2

FOR OPTIONS SEE - NUMERICAL CODE - ON SHEET 2

ITEM	QTY.	DESCRIPTION	MATERIAL	FINISH
11	SEE SHEET 2	ID CARRIER	PVC	TRANSPARENT
10	1	LABEL YELLOW	VINYL	-
9	3 / 4 / 5 / 8	CONTACT MALE	SEE PART LIST	SELECTIVE GOLD OVER NICKEL
8	1	INSERT MALE BLACK	TPU	-
7	1	COUPLING NUT MALE	-	-
6	-	CABLE	SEE SHEET 2	-
5	-	OVERMOULDING BLACK	TPU	-
4	1	COUPLING NUT FEMALE	-	-
3	1	INSERT FEMALE BLACK	PUR	-
2	1	O-RING RED	FPM	-
1	3 / 4 / 5 / 8	CONTACT FEMALE	SEE PART LIST	SELECTIVE GOLD OVER NICKEL

THIS DRAWING CONTAINS INFORMATION THAT IS PROPRIETARY TO MOLEX ELECTRONIC TECHNOLOGIES, LLC AND SHOULD NOT BE USED WITHOUT WRITTEN PERMISSION									
DIMENSION UNITS		SCALE		CURRENT REV DESC: REMOVED OBSOLETE PART NUMBER AS PER PCN#512871.					
mm		1:1		<p>CSE M12 XP AC FE STR MA STR XM DE</p> <p>PRODUCT CUSTOMER DRAWING</p> <p>DOCUMENT NUMBER: 1200668084</p> <p>DOC TYPE: PSD</p> <p>DOC PART: 000</p> <p>REVISION: A15</p>					
GENERAL TOLERANCES (UNLESS SPECIFIED)									
ANGULAR TOL ± 1.0°									
4 PLACES ±		EC NO: 732259							
3 PLACES ±		DRWN: SANTHN 2022/12/20							
2 PLACES ± 0.05		CHK'D: GGA 2022/12/21							
1 PLACE ± 0.3		APPR: GGA 2022/12/21							
0 PLACES ± 0.5		INITIAL REVISION:							
DRAFT WHERE APPLICABLE MUST REMAIN WITHIN DIMENSIONS		THIRD ANGLE PROJECTION		DRAWING		SERIES		MATERIAL NUMBER	
				A3-SIZE		120066		SEE SHEET 3-4	
				GENERAL MARKET				SHEET NUMBER: 1 OF 4	

ENGINEERING NO. - NUMERICAL CODE (Available parts see PART LIST table. Other parts available upon request).

8 8 X 0 3 0 X X X X X X X X

88=Micro-Change
M12x1
Double ended

Contacts:
3=3 Contacts
4=4 Contacts
5=5 Contacts
8=8 Contacts

Heads style:
030=Plug Female Straight
to Plug Male Straight

Cable type: See Table

Units:
M=Meter
C=Centimeter

Length
Examples:
005=0.5 unit
010=1 unit
100=10 units

Overmold color:
Blank (Standard)=Black
A=Grey / G=Black / Y=Yellow

Coupling Nut:
Blank (Standard) & 3=Knurled Brass Ni Plated
1=Hexagonal Stainless steel
5=Knurled Derlin
7=Knurled Brass Ni Plated, Teflon Coated
8=Type 316 stainless steel
9=Knurled / Hexagonal Brass Ni Plated SW13

H= 2 pcs. of I/D Carrier PVC Transparent

COUPLING NUTS
FEMALE MALE



CABLE INFORMATION (for more information see Cable Data Sheet).

CABLE TYPE	NO. OF WIRES	CROSS SECTION	CABLE JACKET	UL	CSA	STATIC: TEMP. / BENDING RADIUS	DYNAMIC: TEMP. / BENDING RADIUS	DRAG CHAIN	SHIELD
E02	3 / 4 / 5 / 8	0.25mm ²	PVC BLACK	UL 2464/1729	C22.2 I/II A/B 80°C/300V	-30°C to +80°C, 10xO.D.	-10°C to +80°C, 15xO.D.	-	-
E03	3 / 4 / 5	0.34mm ²	PVC BLACK	UL 2464/1729	C22.2 I/II A/B 80°C/300V	-30°C to +80°C, 10xO.D.	-10°C to +80°C, 15xO.D.	-	-
H08	3 / 4 / 5 / 8	0.25mm ²	PUR BLACK LS0H	UL 21198/10493	C22.2 I/II A/B 80°C/300V	-40°C to +80°C, 5xO.D.	-25°C to +80°C, 10xO.D.	2 000 000 cycles at 20°C, Temp. range +5°C to +60°C	-
H09	3 / 4 / 5	0.34mm ²	PUR BLACK LS0H	UL 21198/10493	C22.2 I/II A/B 80°C/300V	-40°C to +80°C, 5xO.D.	-25°C to +80°C, 10xO.D.	2 000 000 cycles at 20°C, Temp. range +5°C to +60°C	-
P02	3 / 4 / 5 / 8	0.25mm ²	PUR / PVC BLACK	-	-	-30°C to +80°C, 7xO.D.	-5°C to +80°C, 15xO.D.	-	-
P03	3 / 4 / 5	0.34mm ²	PUR / PVC BLACK	-	-	-30°C to +80°C, 7xO.D.	-5°C to +80°C, 15xO.D.	-	-

OVER [mm]	UP TO AND INCLUDING [mm]	TOLERANCES [mm]
0	305	+19
305	915	+45
915	1830	+56
1830	3660	+89
3660	7320	+165
7320	14640	+317
14640	30500	+610
30500	>	+2% OF FINISHED LENGTH

THIS DRAWING CONTAINS INFORMATION THAT IS PROPRIETARY TO MOLEX ELECTRONIC TECHNOLOGIES, LLC AND SHOULD NOT BE USED WITHOUT WRITTEN PERMISSION

DIMENSION UNITS: mm SCALE: 1:1

CURRENT REV DESC: REMOVED OBSOLETE PART NUMBER AS PER PCN#512871.

molex

CSE M12 XP AC FE STR MA STR XM DE

PRODUCT CUSTOMER DRAWING

EC NO: 732259
DRWN: SANTHN 2022/12/20
CHK'D: GGA 2022/12/21
APPR: GGA 2022/12/21

INITIAL REVISION:
DRWN: JMARSZALEK 2016/09/16
APPR: RSILLER 2016/12/08

DOCUMENT NUMBER: 1200668084
DOC TYPE: PSD
DOC PART: 000
REVISION: A15

DRAFT WHERE APPLICABLE MUST REMAIN WITHIN DIMENSIONS

THIRD ANGLE PROJECTION

DRAWING: A3-SIZE
SERIES: 120066
MATERIAL NUMBER: SEE SHEET 3-4
CUSTOMER: GENERAL MARKET
SHEET NUMBER: 2 OF 4

PART LIST

No.	MOLEX PN	Engineering No.	Length
1	1200060049	884030E03M050	5m
2	1200060050	884030P03M015	1.5m
3	1200060051	884030P03M030	3m
4	1200070081	883030E03M006	0.6m
5	1200070083	883030E03M010	1m
6	1200070085	883030E03M020	2m
7	1200070086	883030E03M0205	2m
8	1200070088	883030E03M030	3m
9	1200070091	883030E03M050	5m
10	1200070092	883030E03M0505	5m
11	1200070093	883030E03M100	10m
12	1200070102	883030P03M003	0.3m
13	1200070104	883030P03M006	0.6m
14	1200070105	883030P03M100	10m
15	1200070470	884030E03M003	0.3m
16	1200070472	884030E03M006	0.6m
17	1200070473	884030E03M010	1m
18	1200070474	884030E03M020	2m
19	1200070475	884030E03M030	3m
20	1200070476	884030E03M100	10m
21	1200070486	884030P03M003	0.3m
22	1200070487	884030P03M006	0.6m
23	1200070488	884030P03M010	1m
24	1200070489	884030P03M020	2m
25	1200070490	884030P03M050	5m
26	1200070586	885030E03M030	3m
27	1200070596	885030P03M020	2m
28	1200070906	885030E03M010	1m
29	1200070969	885030E03M050	5m
30	1200070970	885030E03M020	2m
31	1200071006	883030E03M020H	2m
32	1200071029	884030P03M100	10m
33	1200071047	883030P03M050H	5m
34	1200071049	885030P03M050	5m
35	1200071053	883030P03M150	15m

No.	MOLEX PN	Engineering No.	Length
36	1200071114	883030P03M020H	2m
37	1200071122	883030P03M030H	3m
38	1200071123	883030P03M010H	1m
39	1200071131	883030P03M0201	2m
40	1200071199	884030E03M200	20m
41	1200071273	883030P03M100H	10m
42	1200071284	885030P03M100	10m
43	1200071288	883030P03M060	6m
44	1200071408	885030P03M030	3m
45	1200071500	885030E03M005	0.5m
46	1200071583	885030E03M080	8m
47	1200071594	884030E03M015	1.5m
48	1200071596	884030E03M060	6m
49	1200071703	884030E03M0205	2m
50	1200071707	884030E03M0505	5m
51	1200071715	884030E03M150	15m
52	1200071774	884030E03M020H	2m
53	1200071793	884030E03M1501	* 15m
54	1200071881	884030E03M1005	10m
55	1200071947	885030P03M007	0.7m
56	1200071948	885030E03M040	4m
57	1200072010	884030P03M050H	5m
58	1200072081	885030E03M035	3.5m
59	1200072092	884030E03M040	4m
60	1200072104	883030P03M040	4m
61	1200072105	884030P03M200	20m
62	1200072172	884030E03M050H	5m
63	1200072544	884030E03M120	12m
64	1200072649	884030P03M0105	1m
65	1200072650	884030P03M0505	5m
66	1200072656	885030P03M120	12m
67	1200072658	883030P03M120	12m
68	1200072697	885030E03M060	6m
69	1200072744	884030E03M0501	* 5m
70	1200072762	884030P03M0101	1m

No.	MOLEX PN	Engineering No.	Length
71	1200072763	884030P03M0201	2m
72	1200072764	884030P03M0301	3m
73	1200072803	884030P03M040	4m
74	1200072804	884030P03M060	6m
75	1200073049	885030P03M0501	5m
76	1200073083	885030P03M006	0.6m
77	1200073084	885030P03M150	15m
78	1200660498	883030P03M010	1m
79	1200660500	883030P03M020	2m
80	1200660501	883030P03M030	3m
81	1200660502	883030P03M050	5m
82	1200660579	888030P02M010	1m
83	1200660580	888030P02M020	2m
84	1200660581	888030P02M030	3m
85	1200660582	888030P02M040	4m
86	1200660583	888030P02M050	5m
87	1200660584	888030P02M060	6m
88	1200660585	888030P02M100	10m
89	1200660586	888030P02M150	15m
90	1200661455	888030P02M005	0.5m
91	1200665009	884030E03M005	0.5m
92	1200665031	884030P03M100H	10m
93	1200668062	884030E03M010H	1m
94	1200668084	885030P03M010	1m
95	1200668086	885030P03M0283	2.8m
96	1200668088	885030P03M070	7m
97	1200668163	885030P03M040	4m
98	1200668174	884030H09M030	3m
99	1200668234	884030H09M020	2m
100	1200668238	885030P03M200	20m
101	1200668244	884030H09M050	5m
102	1200668288	888030E02M025	2.5m
103	1200668327	888030P02M200	20m
104	1200668338	885030E03M006	0.6m
105	1200668347	885030E03M100	10m

No.	MOLEX PN	Engineering No.	Length
106	1200668352	888030P02M250	25m
107	1200668370	883030E03M040	4m
108	1200668373	883030H09M006	0.6m
109	1200668374	883030H09M010	1m
110	1200668375	883030H09M030	3m
111	1200668376	883030H09M040	4m
112	1200668377	883030H09M100	10m
113	1200668378	884030H09M006	0.6m
114	1200668379	884030H09M010	1m
115	1200668380	884030H09M040	4m
116	1200668381	884030H09M100	10m
117	1200668399	888030E02M003	0.3m
118	1200668486	884030H09M023	2.3m
119	1200668487	885030E03M200	20m
120	1200668491	888030H08M010	1m
121	1200668497	885030H09M010	1m
122	1200668500	885030H09M020	2m
123	1200668501	885030H09M050	5m
124	1200668502	885030H09M092	9.2m
125	1200668509	885030H09M006	0.6m
126	1200668510	885030H09M030	3m
127	1200668511	885030H09M100	10m
128	1200668521	885030E03M250	25m
129	1200668528	885030E03M020H	2m
130	1200668530	885030E03M010H	1m
131	1200668544	888030P02M500	50m
132	1200668548	884030H09M006H	0.6m
133	1200668549	884030H09M010H	1m
134	1200668550	884030H09M050H	5m
135	1200668602	885030P03M020G	2m
136	1200668609	885030E02M050	5m
137	1200668646	883030P03M030HY	3m
138	1200668652	885030E03M070	7m
139	1200668656	885030E02M100	10m
140	1200668657	885030E02M020	2m

NOTES:

* - Part No. with Yellow PVC overmolding

THIS DRAWING CONTAINS INFORMATION THAT IS PROPRIETARY TO MOLEX ELECTRONIC TECHNOLOGIES, LLC AND SHOULD NOT BE USED WITHOUT WRITTEN PERMISSION									
DIMENSION UNITS	SCALE	CURRENT REV DESC: REMOVED OBSOLETE PART NUMBER AS PER PCN#512871.							
mm	1:1	molex CSE M12 XP AC FE STR MA STR XM DE							
GENERAL TOLERANCES (UNLESS SPECIFIED)									
ANGULAR TOL	± 1.0 °	PRODUCT CUSTOMER DRAWING							
4 PLACES	±	EC NO: 732259	2022/12/20						
3 PLACES	±	DRWN: SANTHN	2022/12/21						
2 PLACES	± 0.05	CHK'D: GGA	2022/12/21						
1 PLACE	± 0.3	APPR: GGA	2022/12/21						
0 PLACES	± 0.5	INITIAL REVISION:		DOCUMENT NUMBER					
DRAFT WHERE APPLICABLE MUST REMAIN WITHIN DIMENSIONS		THIRD ANGLE PROJECTION		DRAWING	SERIES	MATERIAL NUMBER	CUSTOMER		REVISION
				A3-SIZE	120066	1200668084	PSD	000	A15
						SEE PART LIST	GENERAL MARKET		3 OF 4

DOCUMENT STATUS	P1	RELEASE DATE	2022/12/21	07:37:48
-----------------	----	--------------	------------	----------

PART LIST

No.	MOLEX PN	Engineering No.	Length
141	1200668661	884030E02M0031	*0.3m
142	1200668662	883030E02M006	0.6m
143	1200668664	885030E02M010	1m
144	1200668672	884030E03M0051	*0.5m
145	1200668674	885030E03M150	15m
146	1200668683	885030H09M150	15m
147	1200668684	885030H09M200	20m
148	1200668687	884030P03M005	0.5m
149	1200668689	884030H08M030	3m
150	1200668690	883030P03M020YH	2m
151	1200668691	883030P03M010YH	1m
152	1200668712	883030P03M100HY	10m
153	1200668713	883030P03M050HY	5m
154	1200668714	884030H09M0209	2m
155	1200668715	884030H09M003	0.3m
156	1200668718	884030E03M250	25m
157	1200668719	884030E03M300	30m
158	1200668720	884030P03M150	15m
159	1200668721	884030P03M250	25m
160	1200668722	884030P03M300	30m
161	1200668723	884030P03M350	35m
162	1200668724	884030P03M400	40m
163	1200668737	884030H09M055	5.5m
164	1200668754	884030P03M020H	2m
165	1200668765	885030P03M015	1.5m
166	1200668770	884030E03M350	35m
167	1200668771	884030E03M400	40m
168	1200668774	888030H08M100	10m
169	1200668775	885030P03M300	30m
170	1200668777	888030E02M020	2m
171	1200668778	888030E02M030	3m
172	1200668779	888030E02M050	5m
173	1200668780	888030E02M100	10m
174	1200668784	885030E03M300	30m
175	1200668785	885030E03M350	35m

No.	MOLEX PN	Engineering No.	Length
176	1200668786	884030E03M070	7m
177	1200668794	885030P03M006H	0.6m
178	1200668795	885030P03M010H	1m
179	1200668796	885030P03M030H	3m
180	1200668797	885030P03M050H	5m
181	1200668798	885030P03M100H	10m
182	1200668800	885030P03M200H	20m
183	1200668801	885030P03M300H	30m
184	1200668802	885030P03M350H	35m
185	1200668803	888030P02M010H	1m
186	1200668804	888030P02M020H	2m
187	1200668806	888030P02M050H	5m
188	1200668807	888030P02M100H	10m
189	1200668808	888030P02M150H	15m
190	1200668809	888030P02M200H	20m
191	1200668810	888030P02M350H	35m
192	1200668815	884030P03M0805	8m
193	1200668853	885030H09M040	4m
194	1200668854	885030H09M060	6m
195	1200668903	885030P03C130	0.13m
196	1200668972	885030E03M003	0.3m
197	1200668973	885030E03M025	2.5m
198	1200668980	885030E03M080H	8m
199	1200668981	885030E03M040H	4m
200	1200668982	885030E03M060H	6m
201	1200668985	885030E03M030H	3m
202	1200669111	885030P03M150H	15m
203	1200669117	888030H08M040	4m
204	1200669133	888030P02M3008	30m
205	1200669134	883030H09M015	1.5m
206	1200669135	883030H09M200	20m
207	1200669153	883030E03M0101	1m
208	1200669161	888030H08M150	15m
209	1200669212	888030H08M050	5m
210	1200669310	888030H08M005	0.5m

No.	MOLEX PN	Engineering No.	Length
211	1200669311	888030H08M008	0.8m
212	1200669312	888030H08M012	1.2m
213	1200669313	888030H08M015	1.5m
214	1200669314	888030H08C250	0.25m
215	1200669353	888030P02M130	13m
216	1200669423	884030E03M025	2.5m
217	1200669424	884030E03M035	3.5m
218	1200669437	888030H08M200	20m
219	1200669477	888030E02M300	30m
220	1200669478	888030E02M400	40m
221	1200669479	888030E02M500	50m
222	1200669499	883030E03M080	8m
223	1200669500	883030E03M120	12m
224	1200669501	883030E03M140	14m
225	1200669502	883030E03M160	16m
226	1200669503	883030E03M180	18m
227	1200669508	884030E03M080	8m
228	1200669509	884030E03M140	14m
229	1200669510	884030E03M160	16m
230	1200669511	883030E03M060	6m
231	1200669561	883030E02M050	5m
232	1200669350	883030H09M030H	3m
233	1200669609	883030E02M0201	2m
234	1200669717	884030P03M080	8m
235	1200669522	883030E03M200	20m
236	1200669523	883030E03M250	25m
237	1200669752	884030H09M015H	1.5m
238	1200669759	884030H09M020H	2.0m
239	1200669753	884030H09M025H	2.5m
240	1200669758	884030H09M030H	3.0m
241			
242			
243			
244			
245			

No.	MOLEX PN	Engineering No.	Length
246	1200669756	885030H09M015H	1.5m
247	1200669762	885030H09M020H	2.0m
248	1200669757	885030H09M025H	2.5m
249	1200669763	885030H09M030H	3.0m
250	1200669878	884030E03M002H	0.2m
251	1200669879	884030E03M004H	0.4m
252	1200669880	884030E03M009H	0.9m
253	1200669881	884030E03M013H	1.3m
254	1200669882	884030E03M016H	1.6m
255	1200669883	884030E03M180H	18m
256	1200669884	884030E03M800H	80m
257	1200669905	885030E03M085H	8.5m
258	1200669906	885030E03M090H	9m
259	1200669907	885030E03M110H	11m
260	1200669926	884030H09M065H	6.5m
261	1200669927	884030H09M070H	7.0m
262	1200669931	884030H09M075H	7.5m
263	1200669932	884030H09M080H	8.0m
264			
265			
266			
267			
268			
269			
270			
271			
272			
273			
274			
275			
276			
277			
278			
279			
280			

NOTES:

* - Part No. with Yellow PVC overmolding

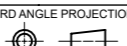
THIS DRAWING CONTAINS INFORMATION THAT IS PROPRIETARY TO MOLEX ELECTRONIC TECHNOLOGIES, LLC AND SHOULD NOT BE USED WITHOUT WRITTEN PERMISSION									
DIMENSION UNITS	SCALE	CURRENT REV DESC: REMOVED OBSOLETE PART NUMBER AS PER PCN#512871.							
mm	1:1	 CSE M12 XP AC FE STR MA STR XM DE							
GENERAL TOLERANCES (UNLESS SPECIFIED)									
ANGULAR TOL	± 1.0°	EC NO: 732259 DRWN: SANTHN 2022/12/20 CHK'D: GGA 2022/12/21 APPR: GGA 2022/12/21							
4 PLACES	±								
3 PLACES	±	INITIAL REVISION: DRWN: JMARSZALEK 2016/09/16 APPR: RSILLER 2016/12/08							
2 PLACES	± 0.05								
1 PLACE	± 0.3	DOCUMENT NUMBER		DOC TYPE	DOC PART	REVISION	 A3-SIZE 120066		
0 PLACES	± 0.5	1200668084		PSD	000	A15			
DRAFT WHERE APPLICABLE MUST REMAIN WITHIN DIMENSIONS		MATERIAL NUMBER		CUSTOMER		SHEET NUMBER			
		SEE PART LIST		GENERAL MARKET		4 OF 4			

FEMALE PLUG M12 STRAIGHT TO MALE PLUG M12 STRAIGHT

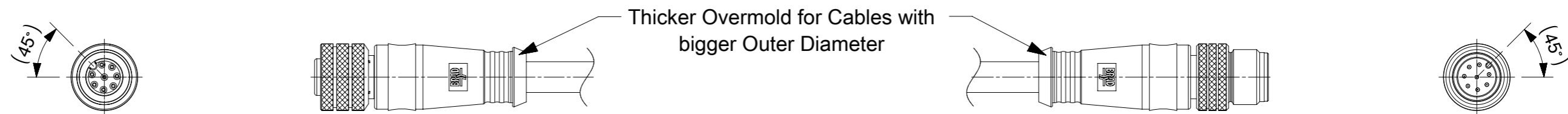
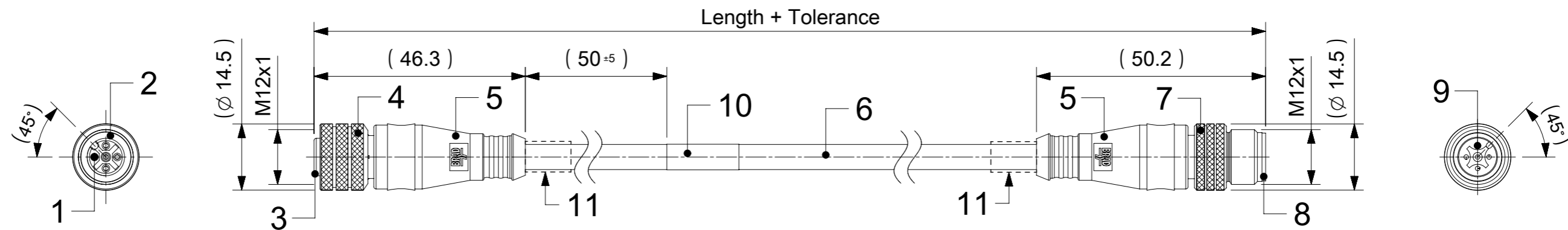

NOTES:

RATED VOLTAGE: 3, 4 contacts 250V per IEC 60664
 5 contacts 60V per IEC 60664
 5 contacts 250V per UL 2238
 8 contacts 30V per IEC 60664

RATED CURRENT: 3, 4, 5 contacts 4A
 8 contacts 2A

PROTECTION CLASS: IP 67

TEMPERATURE: -25°C / +85°C

CONTACTS POSITION FRONT VIEW:

	3 CONTACTS		4 CONTACTS		5 CONTACTS		8 CONTACTS	
FEMALE								
MALE								
CONNECTIONS	PIN	WIRE	PIN	WIRE	PIN	WIRE	PIN	WIRE
	1	BROWN	1	BROWN	1	BROWN	1	WHITE
	2	---	2	WHITE	2	WHITE	2	BROWN
	3	BLUE	3	BLUE	3	BLUE	3	GREEN
	4	BLACK	4	BLACK	4	BLACK	4	YELLOW
	5	---	5	---	5	GREY OR GREEN/YELLOW	5	GREY
							6	PINK
							7	BLUE
						8	RED	

CODING REQUIRED TO IEC 61076-2-101

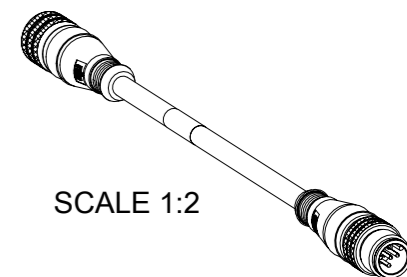

SCALE 1:2

FOR OPTIONS SEE - NUMERICAL CODE - ON SHEET 2

ITEM	QTY.	DESCRIPTION	MATERIAL	FINISH
11	SEE SHEET 2	ID CARRIER	PVC	TRANSPARENT
10	1	LABEL YELLOW	VINYL	---
	-	PRINTING FOR CABLES Ixx	---	---
9	3 / 4 / 5 / 8	CONTACT MALE	SEE PART LIST	SELECTIVE Au OVER Ni
8	1	INSERT MALE BLACK	TPU	---
7	1	COUPLING NUT MALE	---	---
6	-	CABLE	SEE SHEET 2	---
5	-	OVERMOLDING BLACK	TPU	---
4	1	COUPLING NUT FEMALE	---	---
3	1	INSERT FEMALE BLACK	PUR	---
2	1	ORING RED	FPM	---
1	3 / 4 / 5 / 8	CONTACT FEMALE	SEE PART LIST	SELECTIVE Au OVER Ni

THIS DRAWING CONTAINS INFORMATION THAT IS PROPRIETARY TO MOLEX ELECTRONIC TECHNOLOGIES, LLC AND SHOULD NOT BE USED WITHOUT WRITTEN PERMISSION

DIMENSION UNITS: mm SCALE: 1:1

GENERAL TOLERANCES (UNLESS SPECIFIED):

ANGULAR TOL: ± 1.0°

4 PLACES: ±

3 PLACES: ±

2 PLACES: ± 0.05

1 PLACE: ± 0.3

0 PLACES: ± 0.5

DRAFT WHERE APPLICABLE MUST REMAIN WITHIN DIMENSIONS

THIRD ANGLE PROJECTION

DRAWING: A3-SIZE

SERIES: 120066

MATERIAL NUMBER: SEE PART LIST

CUSTOMER: GENERAL MARKET

SHEET NUMBER: 1 OF 4

EC NO: 734641

DRWN: RSCHIEBER 2022/12/01

CHK'D: RSILLER 2023/01/12

APPR: RSILLER 2023/01/12

INITIAL REVISION:

DRWN: JMARSZALEK 2016/09/19

APPR: RSILLER 2016/12/08

DOCUMENT NUMBER: 1200668165

DOC TYPE: PSD

DOC PART: 000

REVISION: A6

PRODUCT CUSTOMER DRAWING

ENGINEERING NO. - NUMERICAL CODE (Available parts see PART LIST table. Other parts available upon request).

8 8 X 0 3 0 X X X X X X X X

OPTIONS

88=Micro-Change
M12x1
Double ended

Contacts:
3=3 Contacts
4=4 Contacts
5=5 Contacts
8=8 Contacts

Heads style:
030=Plug Female Straight
to Plug Male Straight

Cable type: See Table

Units:
M=Meter

Length
Examples:
005=0.5 unit
010=1 unit
100=10 units

Coupling Nut:
Blank (Standard)=Knurled Brass Ni Plated
1=Hexagonal Stainless steel
5=Knurled Derlin
7=Knurled Brass Ni Plated, Teflon Coated
Blank=7 for cables I20, I26, K03, K05, P82, S26
8=Type 316 stainless steel
9=Knurled / Hexagonal Brass Ni Plated SW13

H= 2 pcs. of I/D Carrier PVC Transparent
(Cables Ixx & P82 always with 2 pcs. of I/D Carrier even if no H in Engineering No.)

Overmold color:
Blank (Standard)=Black TPU
Blank=Yellow PVC for cables
A09, S19, S20, S26
Blank=Yellow TPE-E for cables
K03, K05
A=Grey / G=Black / Y=Yellow

COUPLING NUT FEMALE MALE

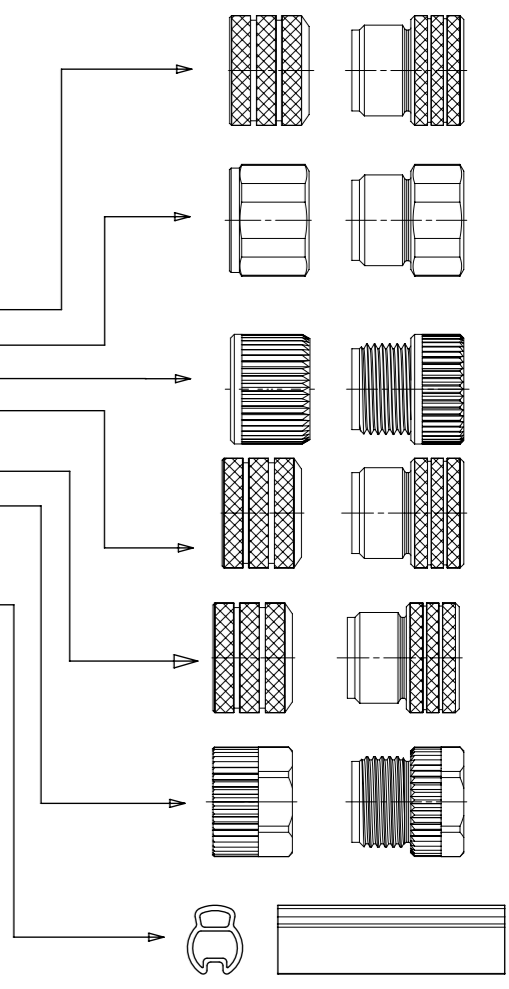

CABLE LENGTH TOLERANCES		
OVER [mm]	UP TO AND INCLUDING [mm]	TOLERANCES [mm]
0	305	+19
305	915	+45
915	1830	+56
1830	3660	+89
3660	7320	+165
7320	14640	+317
14640	30500	+610
30500	>	+2% OF FINISHED LENGTH

THIS DRAWING CONTAINS INFORMATION THAT IS PROPRIETARY TO MOLEX ELECTRONIC TECHNOLOGIES, LLC AND SHOULD NOT BE USED WITHOUT WRITTEN PERMISSION

DIMENSION UNITS	SCALE	CURRENT REV DESC: NEW P/N ADDED		molex		
mm	1:1					
GENERAL TOLERANCES (UNLESS SPECIFIED)				CSE M12 XP AC FE STR MA STR XM DE		
ANGULAR TOL ± 1.0 °				PRODUCT CUSTOMER DRAWING		
4 PLACES	±	EC NO: 734641		DOCUMENT NUMBER		
3 PLACES	±	DRWN: RSCHIEBER	2022/12/01	1200668165		
2 PLACES	± 0.05	CHK'D: RSILLER	2023/01/12	DOC TYPE	DOC PART	REVISION
1 PLACE	± 0.3	APPR: RSILLER	2023/01/12	PSD	000	A6
0 PLACES	± 0.5	INITIAL REVISION:		SHEET NUMBER		
DRAFT WHERE APPLICABLE MUST REMAIN WITHIN DIMENSIONS		DRWN: JMARSZALEK	2016/09/19	2 OF 4		
THIRD ANGLE PROJECTION		APPR: RSILLER	2016/12/08			
DRAWING		SERIES	MATERIAL NUMBER	CUSTOMER		
A3-SIZE		120066	SEE PART LIST	GENERAL MARKET		

CABLE INFORMATION (for more information see Cable Data Sheet).

CABLE TYPE	NO. OF WIRES	CROSS SECTION	CABLE JACKET	UL	CSA	STATIC: TEMP. / BENDING RADIUS	DYNAMIC: TEMP. / BENDING RADIUS	DRAG CHAIN	SHIELD
A09	4	22AWG	PVC YELLOW	UL 2661	I/II A/B 80°C/300V	-	-	-	-
B02	4	18AWG	PUR YELLOW	UL 20549	I/II A/B 80°C/300V	-	-	-	-
E52	3 / 4	0.34mm ²	PVC GREY	-	-	-30°C to +70°C	-5°C to +70°C	-	-
E57	5	0.34mm ²	PVC GREY	-	-	-	-5°C to +70°C	-	-
I02	3 / 4 / 8	0.25mm ²	PVC CEI GREY	-	-	-30°C to +70°C	-5°C to +70°C	-	-
I03	3 / 4 / 5	0.34mm ²	PVC CEI GREY	-	-	-30°C to +70°C	-5°C to +70°C	-	-
I20	3 / 4	0.34mm ²	PVC CEI GREY	-	-	-30°C to +70°C	-5°C to +70°C	-	YES
I26	5	0.34mm ²	PVC CEI GREY	-	-	-30°C to +70°C	-5°C to +70°C	-	YES
K03	4 / 5	18AWG	TPE YELLOW	UL ITC or PLC	I/II A/B 90°C/300V	max 105°C	-	-	-
K05	3 / 4 / 5	22AWG	TPE YELLOW	UL ITC or PLTC	I/II A/B 90°C/300V	max 105°C	-	-	-
P04	4	0.50mm ²	PUR BLACK	-	-	-40°C to +90°C, >7.5xO.D.	-15°C to +90°C, >12.5xO.D.	-	-
P19	8	0.25mm ²	PUR BLACK	-	-	-40°C to +90°C, >7.5xO.D.	-15°C to +90°C, >12.5xO.D.	2 000 000 cycles, >15xO.D.	YES
P20	3 / 4 / 5	0.34mm ²	PUR BLACK LS0H	-	-	-30°C to +80°C	-	-	YES
P82	3 / 4 / 5	0.34mm ²	PUR IRR ORANGE	-	-	-50°C to +105°C, >5xO.D.	-40°C to +105°C, >7.5xO.D.	-	-
S19	8	0.25mm ²	PVC YELLOW	UL 2661/1569	C22.2 II A 105°C/300V	-30°C to +105°C, >10xO.D.	-15°C to +105°C, >15xO.D.	-	YES
S20	3 / 4 / 5	0.34mm ²	PVC YELLOW	UL 2661/1731	C22.2 II A 105°C/300V	-30°C to +105°C	-	-	YES
S26	5	0.34mm ²	PVC YELLOW	UL 2661/1731	C22.2 II A 105°C/300V	-30°C to +105°C	-	-	YES

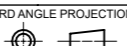
THIS DRAWING CONTAINS INFORMATION THAT IS PROPRIETARY TO MOLEX ELECTRONIC TECHNOLOGIES, LLC AND SHOULD NOT BE USED WITHOUT WRITTEN PERMISSION										
DIMENSION UNITS	SCALE	CURRENT REV DESC: NEW P/N ADDED								
mm	1:1									
GENERAL TOLERANCES (UNLESS SPECIFIED)										
ANGULAR TOL	± 1.0 °	EC NO: 734641 DRWN: RSCHIEBER 2022/12/01 CHK'D: RSILLER 2023/01/12 APPR: RSILLER 2023/01/12								
4 PLACES	±									
3 PLACES	±	PRODUCT CUSTOMER DRAWING								
2 PLACES	± 0.05									
1 PLACE	± 0.3	INITIAL REVISION: DRWN: JMARSZALEK 2016/09/19 APPR: RSILLER 2016/12/08								
0 PLACES	± 0.5									
DRAFT WHERE APPLICABLE MUST REMAIN WITHIN DIMENSIONS		THIRD ANGLE PROJECTION	DRAWING	SERIES	MATERIAL NUMBER	CUSTOMER	DOCUMENT NUMBER	DOC TYPE	DOC PART	REVISION
			A3-SIZE	120066	SEE PART LIST	GENERAL MARKET	1200668165	PSD	000	A6
										SHEET NUMBER
										3 OF 4

DOCUMENT STATUS	P1	RELEASE DATE	2023/01/12	11:47:32
-----------------	----	--------------	------------	----------



PART LIST

No.	Part No.	Engineering No.	Cable Length
1	1200070023	884030S20M060H	6m
2	1200070095	883030I03M003	0.3m
3	1200070096	883030I03M006	0.6m
4	1200070097	883030I03M010	1m
5	1200070098	883030I03M020	2m
6	1200070099	883030I03M030	3m
7	1200070100	883030I03M050	5m
8	1200070101	883030I03M100	10m
9	1200070110	883030S20M010	1m
10	1200070111	883030S20M020	2m
11	1200070480	884030I03M010	1m
12	1200070481	884030I03M020	2m
13	1200070483	884030I03M050	5m
14	1200070484	884030I03M060	6m
15	1200070485	884030I03M100	10m
16	1200070499	884030S20M020	2m
17	1200070500	884030S20M030	3m
18	1200070502	884030S20M050	5m
19	1200070504	884030S20M100	10m
20	1200070597	885030S26M010	1m
21	1200070653	884030E52M200A	20m
22	1200070774	884030I03M006	0.6m
23	1200070785	884030I03M030	3m
24	1200070867	884030E52M100A	10m
25	1200070890	885030I26M010	1m
26	1200070891	885030I26M020	2m
27	1200070892	885030I26M030	3m
28	1200070956	883030E52M020A	2m
29	1200070961	885030I03M030	3m
30	1200071026	884030E52M010A	1m
31	1200071035	884030S20M010H	1m
32	1200071137	884030S20M030H	3m
33	1200071141	884030S20M020H	2m
34	1200071161	884030S20M100H	10m
35	1200071178	884030S20M006H	0.6m
36	1200071188	884030S20M050H	5m
37	1200071237	884030S20M005H	0.5m
38	1200071238	884030S20M015H	1.5m
39	1200071264	884030S20M040H	4m
40	1200071272	884030S20M005	0.5m
41	1200071279	885030I26M050	5m
42	1200071338	884030I20M030	3m
43	1200071343	883030E52M003A	0.3m
44	1200071624	884030E52M030A	3m
45	1200071627	884030I03M0205	2m
46	1200072106	885030I26M005	0.5m
47	1200072359	885030I26M015	1.5m

No.	Part No.	Engineering No.	Cable Length
48	1200660271	884030A09M020	2m
49	1200660273	884030A09M0208	2m
50	1200660277	884030A09M030	3m
51	1200660286	884030A09M0508	5m
52	1200660291	884030A09M070	7m
53	1200660683	884030K05M003	0.3m
54	1200660684	884030K05M005	0.5m
55	1200660686	884030K05M006	0.6m
56	1200660687	884030K05M010	1m
57	1200660688	884030K05M015	1.5m
58	1200660689	884030K05M020	2m
59	1200660690	884030K05M030	3m
60	1200660691	884030K05M040	4m
61	1200660692	884030K05M050	5m
62	1200660693	884030K05M060	6m
63	1200660694	884030K05M080	8m
64	1200660695	884030K05M100	10m
65	1200660696	884030K05M120	12m
66	1200660697	884030K05M150	15m
67	1200660698	884030K05M180	18m
68	1200660699	884030K05M230	23m
69	1200660700	884030K05M300	30m
70	1200660857	884030B02M020	2m
71	1200660860	884030B02M030	3m
72	1200660862	884030B02M050	5m
73	1200660867	884030B02M100	10m
74	1200660878	884030K03M003	0.3m
75	1200660880	884030K03M006	0.6m
76	1200660881	884030K03M010	1m
77	1200660883	884030K03M020	2m
78	1200660887	884030K03M030	3m
79	1200660891	884030K03M040	4m
80	1200660895	884030K03M050	5m
81	1200660898	884030K03M060	6m
82	1200660899	884030K03M070	7m
83	1200660900	884030K03M080	8m
84	1200660901	884030K03M090	9m
85	1200660902	884030K03M100	10m
86	1200660904	884030K03M120	12m
87	1200660905	884030K03M140	14m
88	1200660906	884030K03M150	15m
89	1200660907	884030K03M160	16m
90	1200660909	884030K03M200	20m
91	1200660911	884030K03M250	25m
92	1200660915	884030K05M070	7m
93	1200660918	884030K05M140	14m
94	1200660921	884030K05M200	20m

No.	Part No.	Engineering No.	Cable Length
95	1200660922	884030K05M210	21m
96	1200661034	885030K03M010	1m
97	1200661035	885030K03M020	2m
98	1200661036	885030K03M030	3m
99	1200661038	885030K03M050	5m
100	1200661042	885030K03M090	9m
101	1200661043	885030K03M100	10m
102	1200661044	885030K03M150	15m
103	1200661434	884030E52M020A	2m
104	1200661438	884030K05M250	25m
105	1200661441	884030K05M190	19m
106	1200661472	884030E52M050A	5m
107	1200661543	884030K03M180	18m
108	1200661574	888030S19M120	12m
109	1200661575	888030S19M030	3m
110	1200661576	888030S19M050	5m
111	1200661577	888030S19M100	10m
112	1200661664	885030K03M005	0.5m
113	1200661685	885030K03M120	12m
114	1200661906	884030K03M500	50m
115	1200665012	885030P82M0307	3m
116	1200665368	884030K05M280	28m
117	1200668001	884030K03M110	11m
118	1200668003	884030K03M005	0.5m
119	1200668004	884030K03M240	24m
120	1200668068	884030S20M010	1m
121	1200668082	885030I26M006	0.6m
122	1200668090	885030S26M020H	2m
123	1200668165	885030I03M100	10m
124	1200668172	883030S20M050	5m
125	1200668281	885030I26M025	2.5m
126	1200668310	883030S20M005	0.5m
127	1200668371	883030I03M040	4m
128	1200668372	884030I03M040	4m
129	1200668505	884030P20M010	1m
130	1200668506	884030P20M020	2m
131	1200668507	884030P20M050	5m
132	1200668508	884030P20M100	10m

No.	Part No.	Engineering No.	Cable Length
133	1200668615	884030K05M050H	5m
134	1200668616	884030K05M100H	10m
135	1200668632	883030I03M020Y	2m
136	1200668633	883030I03M030Y	3m
137	1200668634	883030I03M050Y	5m
138	1200668637	884030I03M020Y	2m
139	1200668638	884030I03M100Y	10m
140	1200668639	885030I26M010Y	1m
141	1200668640	885030I26M020Y	2m
142	1200668641	885030I26M030Y	3m
143	1200668642	885030I03M030Y	3m
144	1200668736	885030I26M015Y	1.5m
145	1200668773	885030P82M0107	1m
146	1200668873	885030I26M050Y	5m
147	1200669113	884030A09M0308	3m
148	1200669149	883030I03M010Y	1m
149	1200669218	885030I03M100Y	10m
150	1200669227	884030K05M500	50m
151	1200669228	884030K05M600	60m
152	1200660166	883030A09M010	1m
153	1200660261	884030A09M005	0.5m
154	1200660262	884030A09M006	0.6m
155	1200660266	884030A09M010	1m
156	1200660269	884030A09M015	1.5m
157	1200660294	884030A09M080	8m
158	1200660299	884030A09M1008	10m
159	1200660434	885030A09M050	5m
160	1200661037	885030K03M040	4m
161	1200661039	885030K03M060	6m
162	1200661041	885030K03M080	8m
163	1200661684	885030K03M300	30m
164	1200661686	885030K03M180	18m
165	1200661687	885030K03M230	23m
166	1200668081	885030E57M100A	10m
167	1200669948	884030K05M032	3.2m

THIS DRAWING CONTAINS INFORMATION THAT IS PROPRIETARY TO MOLEX ELECTRONIC TECHNOLOGIES, LLC AND SHOULD NOT BE USED WITHOUT WRITTEN PERMISSION											
DIMENSION UNITS mm		SCALE 1:1		CURRENT REV DESC: NEW P/N ADDED				 CSE M12 XP AC FE STR MA STR XM DE			
GENERAL TOLERANCES (UNLESS SPECIFIED)						EC NO: 734641					
ANGULAR TOL ± 1.0°						4 PLACES ±		DRWN: RSCHIEBER		2023/01/12	
3 PLACES ±						CHK'D: RSILLER		2023/01/12		PRODUCT CUSTOMER DRAWING	
2 PLACES ± 0.05						APPR: RSILLER		2023/01/12		DOCUMENT NUMBER	
1 PLACE ± 0.3						INITIAL REVISION:		2016/09/19		1200668165	
0 PLACES ± 0.5						DRWN: JMARSZALEK		2016/12/08		DOC TYPE DOC PART REVISION	
DRAFT WHERE APPLICABLE MUST REMAIN WITHIN DIMENSIONS						THIRD ANGLE PROJECTION		DRAWING		SERIES	
								A3-SIZE		4 OF 4	
						MATERIAL NUMBER		CUSTOMER		SHEET NUMBER	
						SEE PART LIST		GENERAL MARKET		4 OF 4	

DOCUMENT STATUS	P1	RELEASE DATE	2023/01/12	11:47:32
-----------------	----	--------------	------------	----------

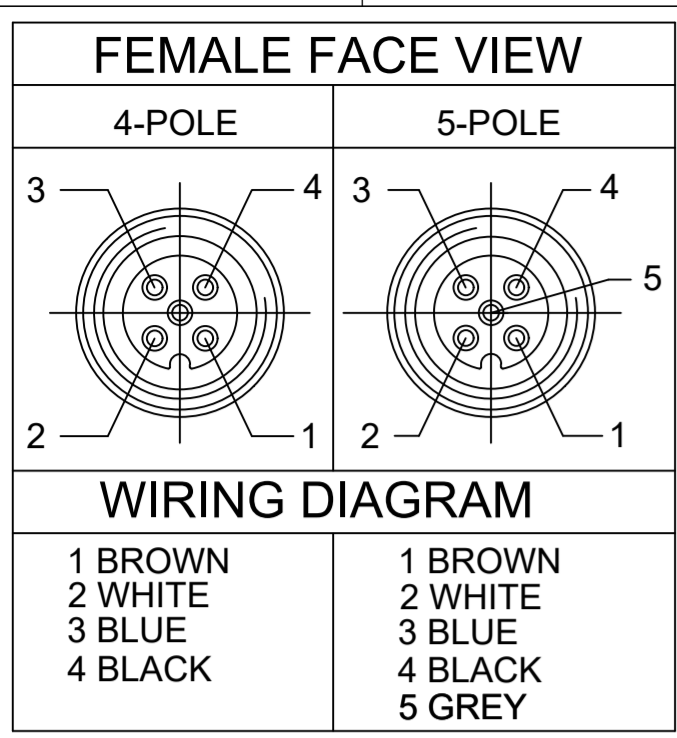

PART NO	ENGINEERING NO.	FINISHED LENGTH	POLES	CABLE DIA.
1200660878	884030K03M003	0.3M [12 IN]	4	.26 [6.6]
1200662229	885030K03M700	70M [229FT 8 IN]	5	.28 [7.1]

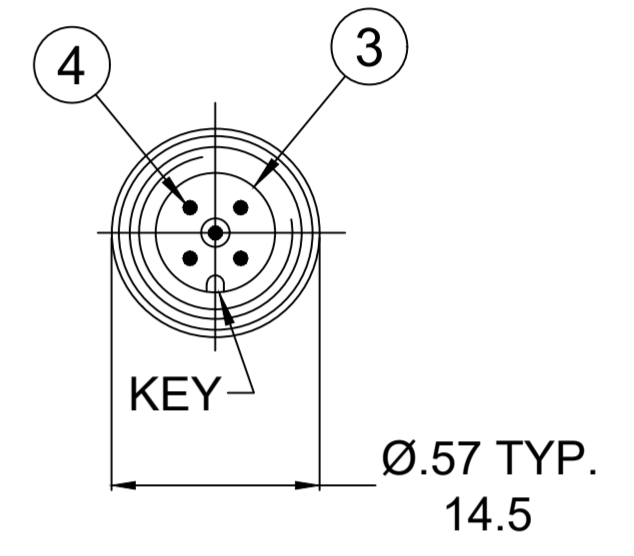
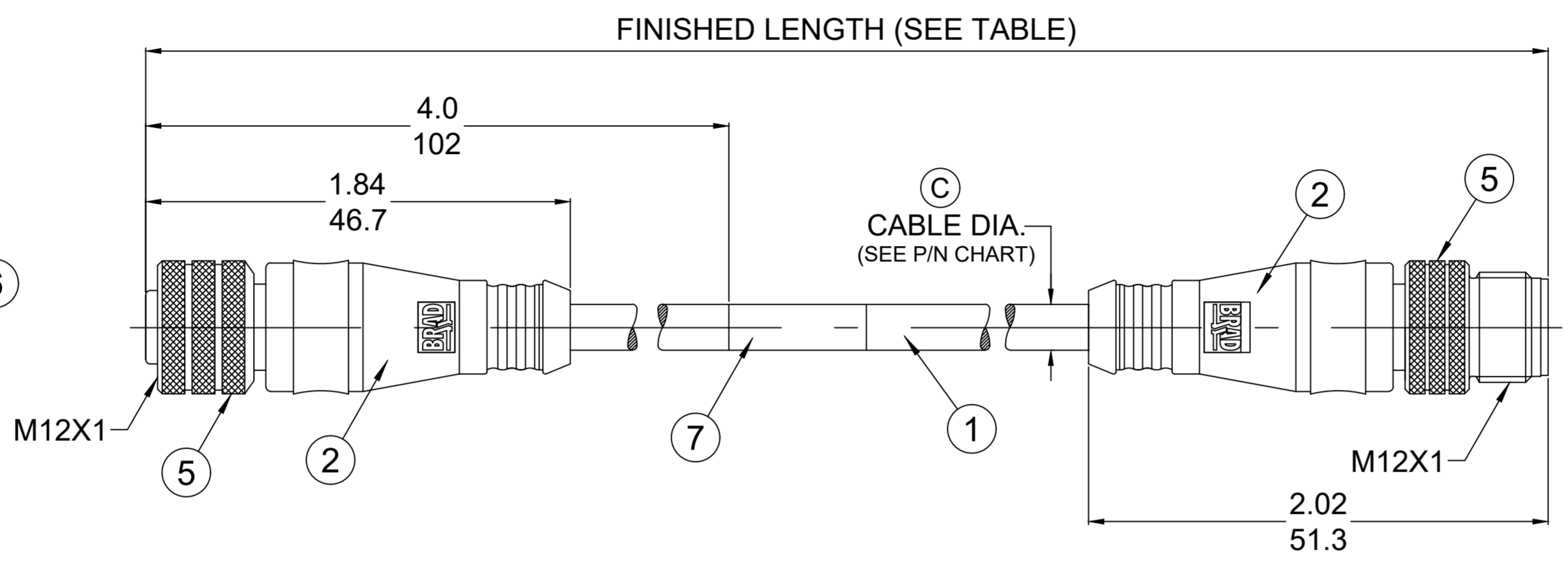
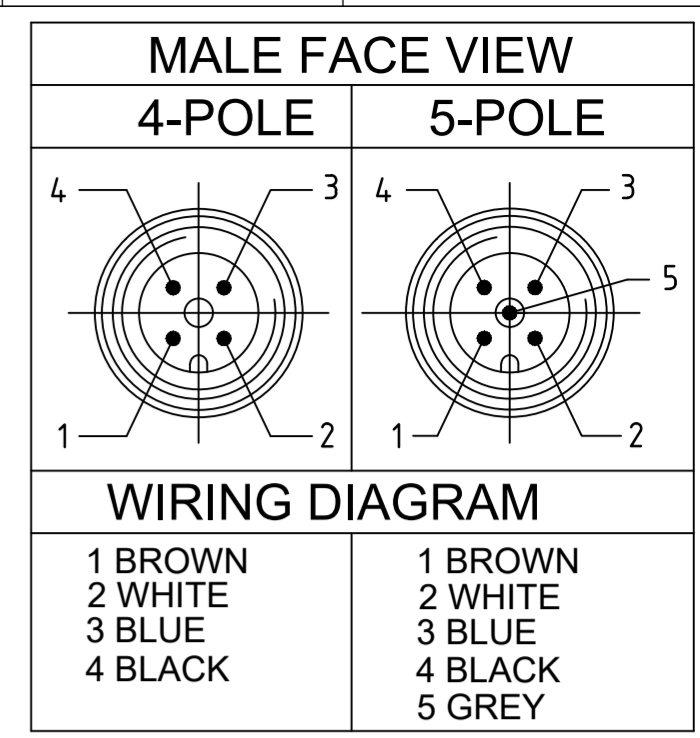

- NOTES:
1. MATERIAL: AS NOTED
 2. FINISH: AS NOTED
 3. ELECTRICAL:
VOLTAGE: 4 & 5P 250V
CURRENT: 4A
 4. TEMP RATING: -20°TO +105°C
 5. PROTECTION: IP67 (WHEN MATED)
 6. UL RECOGNIZED FILE: E152210
CSA CERTIFIED FILE: LR6837 (C)
 7. ALL DIMENSIONS ARE FOR REFERENCE
UNLESS TOLERANCED OR NOTED OTHERWISE

PART NO. MATRIX 88X030K03XXXX

POLES (4, 5) LENGTH
M010 = 1 METER
M050 = 5 METER
M100 = 10 METER

MECHANICAL CHARACTERISTICS: (C)

TORSIONAL FLEX TEST	10 MILLION CYCLES PER MIL-C-13777G
BEND FLEX TEST	10 MILLION CYCLES PER MIL-C-13777G
WELD SLAG RESISTANCE	WOODHEAD STANDARD S-300

ITEM	COMPONENT	MATERIAL	FINISH
1	CABLE-#18/4-5	TPE JACKET	YELLOW
2	OVERMOLD	TPC	YELLOW
3	INSERT	PUR	BLACK
4	SOCKET/PIN CONTACT	COPPER ALLOY	GOLD OVER NICKEL
5	COUPLER	BRASS	TEFLON/NICKEL
6	O-RING	VITON	RED
7	LABEL	MYLAR	BLACK/YELLOW

(C)

CABLE LENGTH TOLERANCES

<.3M [1FT]:	+19mm-0 [+.75in-0]
.3 - .9M [1 - 3FT]:	+44.5mm-0 [+1.75in-0]
.9 - 1.8M [3 - 6FT]:	+55.6mm-0 [+2.19in-0]
1.8 - 3.7M [6 - 12FT]:	+88.9mm-0 [+3.50in-0]
3.7 - 7.3M [12 - 24FT]:	+165.1mm-0 [+6.50in-0]
7.3-14.6M [24 - 48FT]:	+317.5mm-0 [+12.50in-0]
14.6 - 30.5M [48-100FT]:	+622.3mm-0 [+24.50in-0]
OVER 30M [100FT]	+2% OF FINISHED LENGTH

THIS DRAWING CONTAINS INFORMATION THAT IS PROPRIETARY TO MOLEX ELECTRONIC TECHNOLOGIES, LLC AND SHOULD NOT BE USED WITHOUT WRITTEN PERMISSION

FUNCTIONAL SYMBOLS: FA=0, EC=0, EP=0

DIMENSION UNITS: INCH/MM SCALE: NTS

GENERAL TOLERANCES (UNLESS SPECIFIED):

	mm	INCH
4 PLACES	±----	±----
3 PLACES	±----	±----
2 PLACES	±----	±----
1 PLACE	±----	±----
0 PLACES	±----	±----

ANGULAR TOL ± ---- °

DRAFT WHERE APPLICABLE MUST REMAIN WITHIN DIMENSIONS

THIRD ANGLE PROJECTION

DRAWING: C-SIZE

SERIES: 120066

CURRENT REV DESC: ITEM# 2 WAS TPE. REMOVED 3P DETAILS. ADDED CSA, MECH CHARACTERISTICS & TOL CHART. ADDED DIMS & MATERIAL TABLE.

EC NO: 645633

DRWN: ABENJAMINLW 2020/09/18

CHK'D: RSTONE 2020/09/29

APPR: BWOODMAN 2020/10/23

INITIAL REVISION:

DRWN: LSTEMMLE 2010/02/01

APPR: FPACHER 2010/02/03

DOCUMENT NUMBER: SD-120066-020

DOC TYPE/DOC PART/REVISION: PSD/001/C

MATERIAL NUMBER: SEE CHART

CUSTOMER: GENERAL MARKET

SHEET NUMBER: 1 OF 1