

TPS22811EVM: Evaluation Module for TPS22811 Load Switch



ABSTRACT

This user's guide describes the evaluation module (EVM) for the TPS22811 load switch. The TPS22811 device is a 2.7-V to 16-V, 10-A load switch with integrated 6-mΩ FET with inrush current protection and programmable undervoltage and overvoltage protection.

	<p>Caution</p>	<p>Caution Hot surface. Contact may cause burns. Do not touch!</p>
---	----------------	--

Table of Contents

1 Introduction	3
1.1 EVM Features.....	3
1.2 EVM Applications.....	3
2 Description	3
3 Schematic	4
4 General Configurations	5
4.1 Physical Access.....	5
4.2 Test Equipment and Setup.....	6
5 Test Setup and Procedures	7
5.1 Hot-Plug Test.....	9
5.2 Overvoltage Test.....	10
6 EVAL Board Assembly Drawings and Layout Guidelines	11
6.1 PCB Drawings.....	11
7 Bill of Materials (BoM)	13
8 Revision History	15

List of Figures

Figure 3-1. TPS22811EVM Load Switch Evaluation Board Schematic.....	4
Figure 5-1. TPS22811EVM Setup with Test Equipment.....	7
Figure 5-2. TPS22811 Output Rise Profile (VIN = 12 V, Cout = 10 uF, CdVdT = OPEN, No Load).....	9
Figure 5-3. Overvoltage Protection Response of the TPS22811 Device.....	10
Figure 6-1. TPS22811EVM Board (a) Top Assembly (b) Bottom Assembly.....	11
Figure 6-2. TPS22811EVM Board (a) Top Layer (b) Bottom Layer.....	12

List of Tables

Table 2-1. TPS22811EVM Load Switch Evaluation Board Options and Setting.....	3
Table 4-1. Input and Output Connector Functionality.....	5
Table 4-2. Test Points Description.....	5
Table 4-3. Jumper Descriptions and Default Positions.....	5
Table 4-4. LED Descriptions.....	6
Table 5-1. Default Jumper Setting for TPS22811EVM eFuse Evaluation Board.....	7
Table 7-1. Bill of Materials.....	13

Trademarks

All trademarks are the property of their respective owners.

1 Introduction

The *TPS22811EVM Load Switch Evaluation Board* allows reference circuit evaluation of the Texas Instruments (TI) TPS22811 load switch. The TPS22811 device is a 2.7-V to 16-V, 10-A load switch with integrated 6-m Ω FET inrush current protection and programmable undervoltage and overvoltage protection.

1.1 EVM Features

General TPS22811EVM load switch evaluation board features include:

- 2.7-V to 16-V (typical) operation
- Programmable output voltage slew rate control
- Load current monitor output (IMON)
- TVS diode for input transient protection
- Onboard Schottky diode at output prevents negative spike during overcurrent faults
- LED status for power indication

1.2 EVM Applications

This EVM can be used on the following applications:

- Server motherboard/add-on cards/NIC
- Optical modules
- Enterprise switches/routers
- Industrial PC
- UHDTV

2 Description

The TPS22811EVM load switch Evaluation Board has one channel and enables evaluation of the TPS22811L load switch. Channel 1 is a standalone channel and provides programmable OVLO, dVdt, and IMON settings. The input power is applied at connector J9 while J14 provides the output connection. Refer to the schematic in [Figure 3-1](#) and EVM test setup in [Figure 5-1](#). TVS diode D2 provides input protection from transient overvoltages, while Schottky diode D12 provides output protection for the TPS22811 load switch.

S2 allows U1 to be RESET or disabled.

Table 2-1. TPS22811EVM Load Switch Evaluation Board Options and Setting

EVM Function	Channel	Vin UVLO Threshold	Vin OVLO Threshold	Output Slew Rate, dVdt	Load Current Monitor, VIMON/ IIOOUT
2.7-V to 16-V, 10-A load switch	CH1	10.84 V	Selectable OVLO – 3.77 V, 5.67 V, 13.76 V Note: OVLO must be greater than UVLO threshold	Selectable –1 mV/us, 0.33 mV/us, 0.15 mV/us	Selectable

3 Schematic

Figure 3-1 illustrates the EVM schematic.

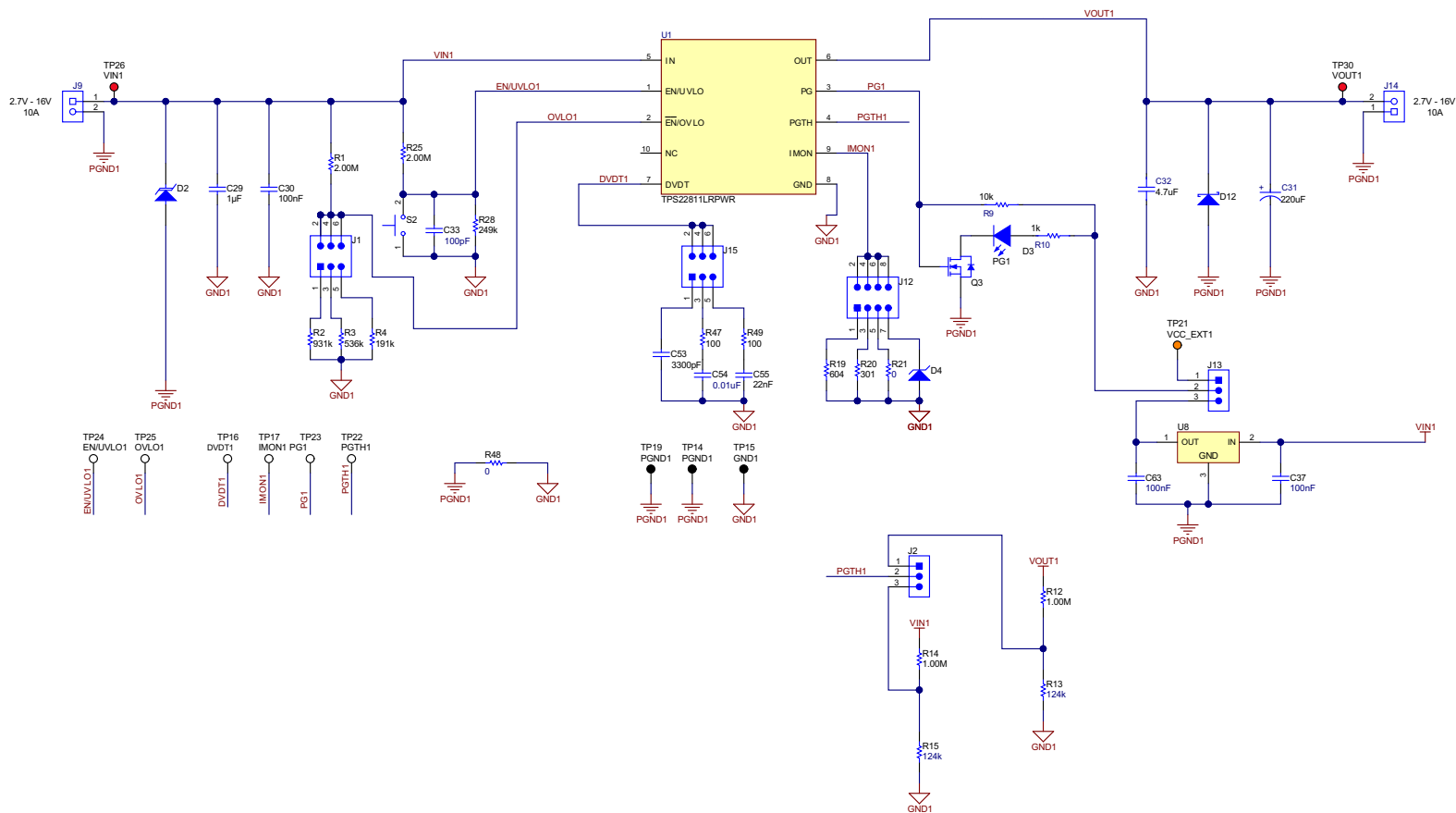

Figure 3-1. TPS22811EVM Load Switch Evaluation Board Schematic

4 General Configurations

4.1 Physical Access

Table 4-1 lists the TPS22811EVM load switch Evaluation Board input and output connector functionality. Table 4-2 and Table 4-3 describe the test point availability and the jumper functionality. Table 4-4 describes the function of signal LEDs.

Table 4-1. Input and Output Connector Functionality

Channel	Connector	Label	Description
CH1	J9	VIN1(+), PGND(-)	Input of CH1
	J14	VOUT1(+), PGND(-)	Output of CH1

Table 4-2. Test Points Description

Channel	Test Points	Label	Description
CH1	TP26	VIN1	CH1 input voltage
	TP30	VOUT1	CH1 output voltage
	TP24	EN/UVLO1	CH1 EN/UVLO signal
	TP25	OVLO1	CH1 OVLO signal
	TP16	dVdt1	CH1 output voltage ramp control
	TP17	IMON1	CH1 current monitor
	TP23	PG1	CH1 power good signal
	Tp22	PGTH1	CH1 power good threshold signal
	TP21	VCC_EXT1	CH1 external VCC voltage point for U8 LDO
	TP15	GND1	CH1 IC GND signal
	TP14,TP19	PGND1	CH1 power GND signal

Table 4-3. Jumper Descriptions and Default Positions

Channel	Jumper	Label	Description	Default Jumper Position
CH1	J1	OVLO1	1-2 position sets input OVLO threshold at 3.77 V	5-6
			3-4 position sets input OVLO threshold at 5.67 V	
			5-6 position sets input OVLO threshold to 13.76 V	
	J15	dVdt1	1-2 position sets the output slew rate to 1 mV/us	3-4
			3-4 position the sets output slew rate to 0.33 mV/us	
			5-6 position sets the output slew rate to 0.15 mV/us	
	J12	IMON1	1-2 position sets VIMON/IOUT = 0.06	1-2 and 7-8
			3-4 position sets VIMON/IOUT = 0.03	
			Select only 5-6 position if IMON pin is not used	
			7-8 position connects a low voltage clamping diode to protect IMON pin from transients	
	J13	VCC connection	1-2 position connects external voltage, VCC_EXT1 as reference for PG1	2-3
			2-3 position connects onboard generated voltage, VCC as reference for PG1	
J2	PGTH1	1-2 position monitors the output voltage	1-2	
		2-3 position monitors the input supply		

Table 4-4. LED Descriptions

LED	Description
D3	When ON, indicates that PG is asserted for channel 1

4.2 Test Equipment and Setup

4.2.1 Power Supplies

One adjustable power supply with 0-V to 20-V output and current limit greater than 10 A.

4.2.2 Meters

One DMM minimum needed.

4.2.3 Oscilloscope

A DPO2024 or equivalent, three 10x voltage probes, and a DC current probe.

4.2.4 Loads

One resistive load or equivalent that can tolerate up to 10-A DC load at 16 V and capable of the output short.

5 Test Setup and Procedures

In this user's guide section, the test procedure is described for TPS22811EVM testing.

Make sure the evaluation board has default jumper settings as shown in [Table 5-1](#).

Table 5-1. Default Jumper Setting for TPS22811EVM eFuse Evaluation Board

J1	J12	J15	J13	J2
5-6	1-2 and 7-8	3-4	2-3	1-2

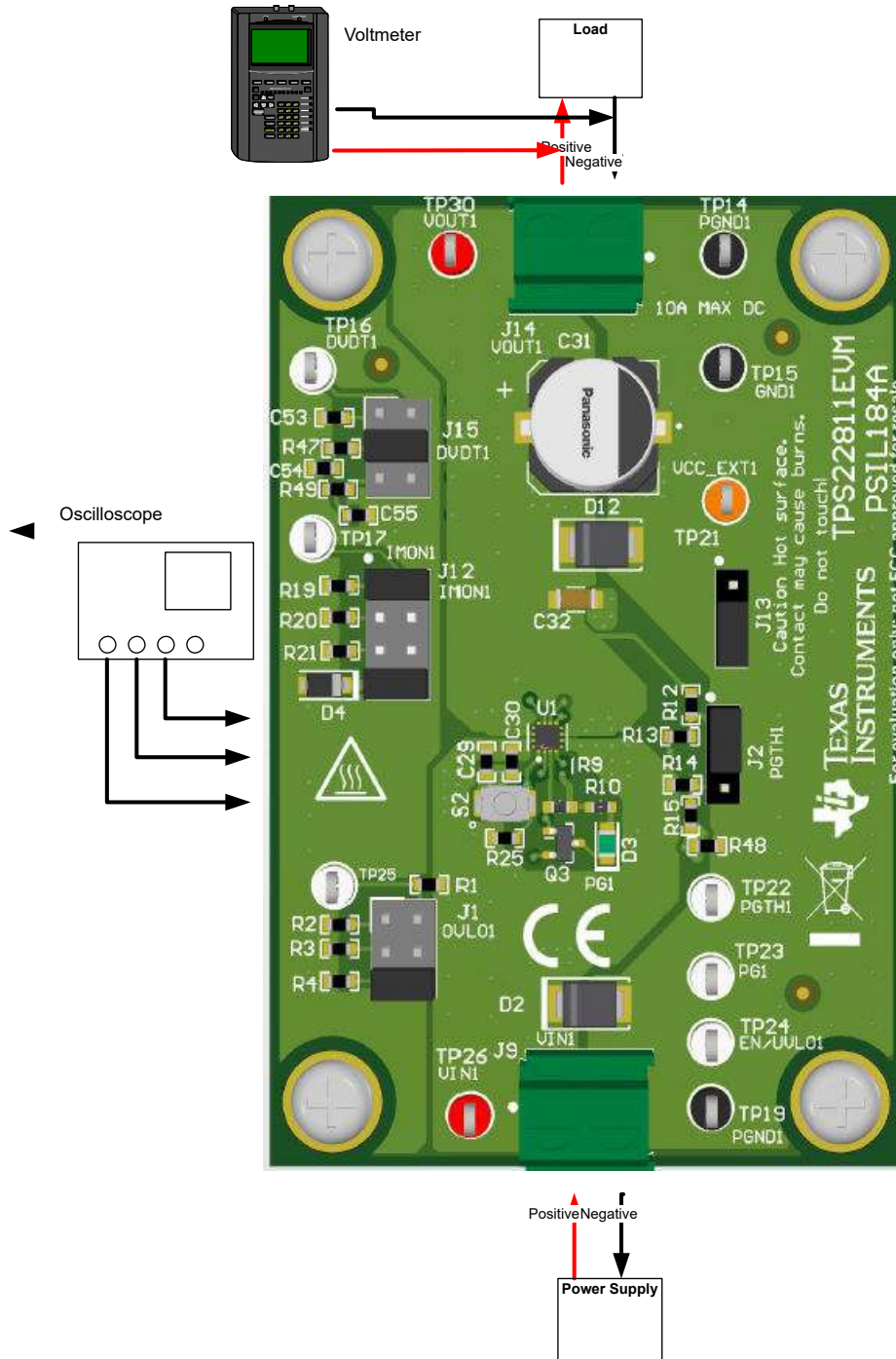

Figure 5-1. TPS22811EVM Setup with Test Equipment

Follow these instructions before starting any test and repeat again before moving to the next test:

- Set the power supply output (VIN) to zero volts.
- Turn ON the power supply and set the power supply output (VIN) to 12 V, current limit = 10 A.
- Turn OFF the power supply.
- Set the jumper setting on EVM to default position as shown in [Table 5-1](#).

5.1 Hot-Plug Test

Use the following instructions to measure the inrush current during the Hot-Plug event on channel 1:

1. Set Jumper J3 position to desired slew rate as mentioned in [Table 4-3](#).
2. Set the input supply voltage VIN to 12 V and current limit of 12 A. Enable the power supply.
3. Hot-plug the supply between VIN1 and PGND1 points of connector J9.
4. Observe the waveform at VOUT1 (TP30) and input current with an oscilloscope to measure the slew rate and rise time of the eFuse with a given input voltage of 12 V.

Figure 5-2 shows an example of inrush current captured on the TPS22811EVM eFuse evaluation board.

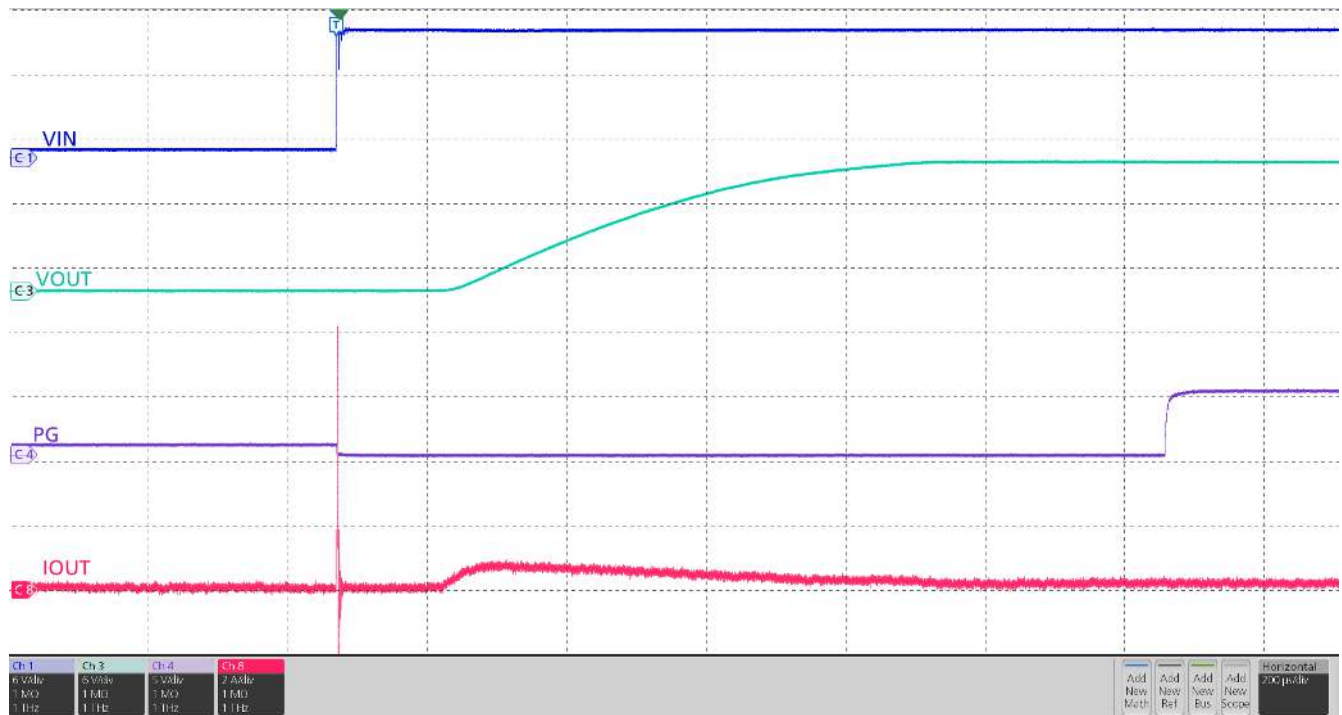

Figure 5-2. TPS22811 Output Rise Profile (VIN = 12 V, Cout = 10 μ F, CdVdT = OPEN, No Load)

5.2 Overvoltage Test

Use the following instructions to perform the overvoltage protection test on channel 1:

1. Remove input TVS diodes.
2. Place jumper J1 in suitable position to set the required OVLO threshold as per [Table 4-3](#). For example, consider setting 5-6 to set threshold as 13.76 V.
3. Set the input supply voltage VIN to 12 V and current limit of 12 A. Apply the supply between VIN1 and PGND1 at connector J9 and enable the power supply.
4. Increase the input supply VIN from 12 V to 16 V and observe the waveforms using an oscilloscope.

Figure 5-3 shows overvoltage response of TPS22811 on the TPS22811EVM eFuse evaluation board.

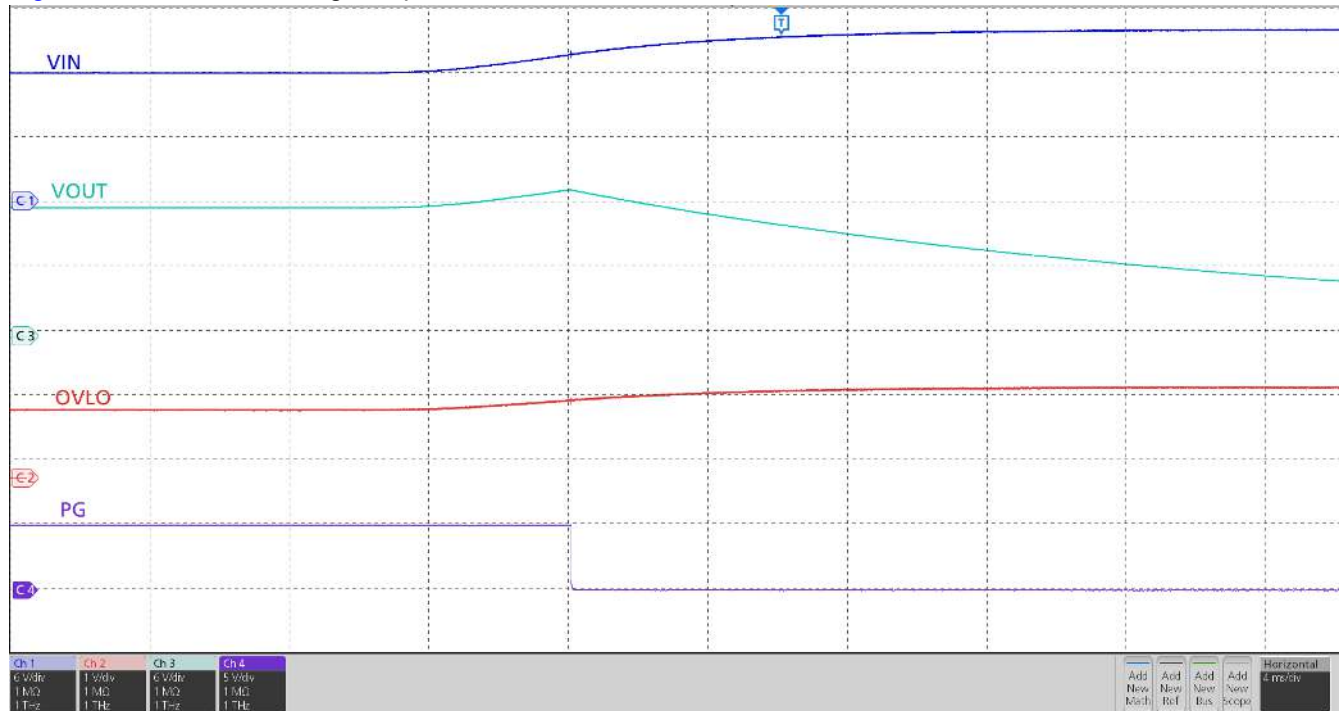

Figure 5-3. Overvoltage Protection Response of the TPS22811 Device

6 EVAL Board Assembly Drawings and Layout Guidelines

6.1 PCB Drawings

Figure 6-1 shows component placement of the EVAL Board. Figure 6-2 shows PCB layout images.

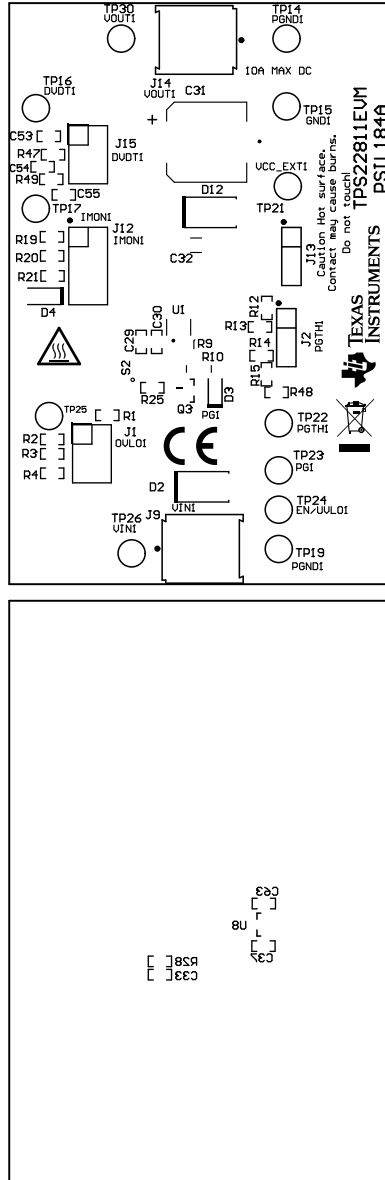

Figure 6-1. TPS22811EVM Board (a) Top Assembly (b) Bottom Assembly

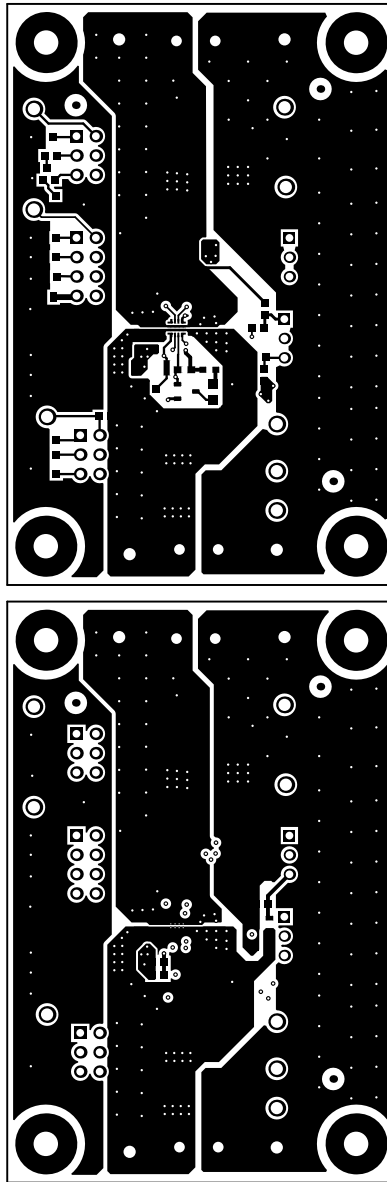

Figure 6-2. TPS22811EVM Board (a) Top Layer (b) Bottom Layer

7 Bill of Materials (BoM)

Table 7-1 lists the EVM BoM.

Table 7-1. Bill of Materials

Designator	Quantity	Value	Description	Package Reference	Part Number	Manufacturer
IPCB	1		Printed Circuit Board		PSIL184	Any
C29	1	1 uF	CAP, CERM, 1 uF, 35 V, +/- 10%, X7R, 0603	0603	C1608X7R1V105K080AC	TDK
C30	1	0.1 uF	CAP, CERM, 0.1 uF, 50 V, +/- 10%, X7R, 0603	0603	C1608X7R1H104K080AA	TDK
C31	1	220 µF	220 µF 35 V Aluminum Electrolytic Capacitors Radial, Can - SMD 150mOhm @ 100kHz 3000 Hrs @ 125°C	RADIAL	EEE-TP1V221AV	Panasonic
C32	1	4.7 µF	Cap Ceramic 4.7uF 50V X7R 20% Pad SMD 1206 +125°C Automotive T/R	1206	CGA5L3X7R1H475M160AE	TDK
C33	1	100 pF	CAP, CERM, 100 pF, 50 V, +/- 5%, C0G/NP0, 0603	0603	885012006057	Wurth Elektronik
C37, C63	2	0.1 uF	CAP, CERM, 0.1 uF, 50 V, +/- 10%, X7R, 0603	0603	06035C104KAT2A	AVX
C53	1	3300 pF	CAP, CERM, 3300 pF, 50 V, +/- 10%, X7R, 0603	0603	C0603X332K5RACTU	Kemet
C54	1	0.01 uF	CAP, CERM, 0.01 uF, 50 V, +/- 5%, C0G/NP0, 0603	0603	GRM1885C1H103JA01D	MuRata
C55	1	0.022 uF	CAP, CERM, 0.022 uF, 50 V, +/- 10%, X7R, 0603	0603	C0603X223K5RACTU	Kemet
D2	1	13 V	Diode, TVS, Uni, 13 V, 21.5 Vc, SMB	SMB	SMBJ13A-13-F	Diodes Inc.
D3	1	PG1	LED, Green, SMD	LED_0805	LTST-C170KGKT	Lite-On
D4	1	1.8 V	Diode, Zener, 1.8 V, 500 mW, SOD-123	SOD-123	MMSZ4678T1G	ON Semiconductor
D12	1		Diode Schottky 30 V 3A Surface Mount SMAF	SMAF	B330AF-13	Diodes
FID1, FID2, FID3, FID4, FID5, FID6	6		Fiducial mark. There is nothing to buy or mount.	N/A	N/A	N/A
H1, H2, H3, H4	4		Machine Screw, Round, #4-40 x 1/4, Nylon, Philips panhead	Screw	NY PMS 440 0025 PH	B&F Fastener Supply
H5, H6, H7, H8	4		Standoff, Hex, 0.5"L #4-40 Nylon	Standoff	1902C	Keystone
J1, J15	2		Header, 100mil, 3x2, Tin, TH	3x2 Header	PEC03DAAN	Sullins Connector Solutions
J2, J13	2		Header, 100mil, 3x1, Tin, TH	Header, 3 PIN, 100mil, Tin	PEC03SAAN	Sullins Connector Solutions
J9, J14	2		Terminal Block, 2x1, 5.08mm, TH	10.16x15.2x9mm	282841-2	TE Connectivity
J12	1		Header, 100mil, 4x2, Tin, TH	Header, 4x2, 100mil, Tin	PEC04DAAN	Sullins Connector Solutions
Q3	1	60 V	MOSFET, N-CH, 60 V, 115 A, SOT-23	SOT-23	2N7002	Fairchild Semiconductor
R1, R25	2	2.00Meg	RES, 2.00 M, 1%, 0.1 W, 0603	0603	RC0603FR-072ML	Yageo

Table 7-1. Bill of Materials (continued)

Designator	Quantity	Value	Description	Package Reference	Part Number	Manufacturer
R2	1	931k	RES, 931 k, 1%, 0.1 W, 0603	0603	RC0603FR-07931KL	Yageo
R3	1	536k	RES, 536 k, 1%, 0.1 W, 0603	0603	RC0603FR-07536KL	Yageo
R4	1	191k	RES, 191 k, 1%, 0.1 W, 0603	0603	RC0603FR-07191KL	Yageo
R9	1	10k	10 kOhms \pm 0.1% 0.1W, 1/10W Chip Resistor 0603 (1608 Metric) Current Sense Thin Film	0603	CRT0603-BY-1002ELF	Bourns Inc.
R10	1	1k	1 kOhms \pm 1% 0.1W, 1/10W Chip Resistor 0603 (1608 Metric) Automotive AEC-Q200, Moisture Resistant Thick Film	0603	AC0603FR-071KL	Yageo
R12, R14	2	1.00Meg	RES, 1.00 M, 1%, 0.1 W, 0603	0603	RC0603FR-071ML	Yageo
R13, R15	2	124k	RES, 124 k, 1%, 0.1 W, AEC-Q200 Grade 0, 0603	0603	CRCW0603124KFKEA	Vishay-Dale
R19	1	604	RES, 604, 1%, 0.1 W, 0603	0603	RC0603FR-07604RL	Yageo
R20	1	301	RES, 301, 1%, 0.1 W, 0603	0603	RC0603FR-07301RL	Yageo
R21, R48	2	0	RES, 0, 5%, 0.1 W, 0603	0603	ERJ-3GEY0R00V	Panasonic
R28	1	249k	RES, 249 k, 1%, 0.1 W, 0603	0603	RC0603FR-07249KL	Yageo
R47, R49	2	100	RES, 100, 1%, 0.1 W, 0603	0603	RC0603FR-07100RL	Yageo
S2	1		Switch, SPST-NO, 0.05 A, 12 VDC, SMT	3.9x2.9mm	SKRKAEE020	Alps
SH-J1, SH-J2, SH-J3, SH-J4, SH-J6, SH-J7	6	1x2	Shunt, 100mil, Flash Gold, Black	Closed Top 100mil Shunt	SPC02SYAN	Sullins Connector Solutions
TP14, TP15, TP19	3		Test Point, Multipurpose, Black, TH	Black Multipurpose Testpoint	5011	Keystone
TP16, TP17, TP22, TP23, TP24, TP25	6		Test Point, Multipurpose, White, TH	White Multipurpose Testpoint	5012	Keystone
TP21	1		Test Point, Multipurpose, Orange, TH	Orange Multipurpose Testpoint	5013	Keystone
TP26, TP30	2		Test Point, Multipurpose, Red, TH	Red Multipurpose Testpoint	5010	Keystone
U1	1		2.7- 16 V, 10 A, 7 m Ω load switch with adjustable overvoltage protection & current monitoring	QFN10	TPS22811LRPWR	Texas Instruments
U8	1		100 mA, Quasi Low-Dropout Linear Voltage Regulator, 3-pin SOT-23, Pb-Free	DBZ0003A	LM3480IM3-3.3/NOPB	Texas Instruments

8 Revision History

NOTE: Page numbers for previous revisions may differ from page numbers in the current version.

Changes from Revision * (April 2022) to Revision A (June 2022)	Page
• Updated Figure 3-1	4
• Updated Figure 6-1 and Figure 6-2	11

STANDARD TERMS FOR EVALUATION MODULES

1. *Delivery:* TI delivers TI evaluation boards, kits, or modules, including any accompanying demonstration software, components, and/or documentation which may be provided together or separately (collectively, an "EVM" or "EVMs") to the User ("User") in accordance with the terms set forth herein. User's acceptance of the EVM is expressly subject to the following terms.
 - 1.1 EVMs are intended solely for product or software developers for use in a research and development setting to facilitate feasibility evaluation, experimentation, or scientific analysis of TI semiconductors products. EVMs have no direct function and are not finished products. EVMs shall not be directly or indirectly assembled as a part or subassembly in any finished product. For clarification, any software or software tools provided with the EVM ("Software") shall not be subject to the terms and conditions set forth herein but rather shall be subject to the applicable terms that accompany such Software
 - 1.2 EVMs are not intended for consumer or household use. EVMs may not be sold, sublicensed, leased, rented, loaned, assigned, or otherwise distributed for commercial purposes by Users, in whole or in part, or used in any finished product or production system.
2. *Limited Warranty and Related Remedies/Disclaimers:*
 - 2.1 These terms do not apply to Software. The warranty, if any, for Software is covered in the applicable Software License Agreement.
 - 2.2 TI warrants that the TI EVM will conform to TI's published specifications for ninety (90) days after the date TI delivers such EVM to User. Notwithstanding the foregoing, TI shall not be liable for a nonconforming EVM if (a) the nonconformity was caused by neglect, misuse or mistreatment by an entity other than TI, including improper installation or testing, or for any EVMs that have been altered or modified in any way by an entity other than TI, (b) the nonconformity resulted from User's design, specifications or instructions for such EVMs or improper system design, or (c) User has not paid on time. Testing and other quality control techniques are used to the extent TI deems necessary. TI does not test all parameters of each EVM. User's claims against TI under this Section 2 are void if User fails to notify TI of any apparent defects in the EVMs within ten (10) business days after delivery, or of any hidden defects with ten (10) business days after the defect has been detected.
 - 2.3 TI's sole liability shall be at its option to repair or replace EVMs that fail to conform to the warranty set forth above, or credit User's account for such EVM. TI's liability under this warranty shall be limited to EVMs that are returned during the warranty period to the address designated by TI and that are determined by TI not to conform to such warranty. If TI elects to repair or replace such EVM, TI shall have a reasonable time to repair such EVM or provide replacements. Repaired EVMs shall be warranted for the remainder of the original warranty period. Replaced EVMs shall be warranted for a new full ninety (90) day warranty period.

WARNING

Evaluation Kits are intended solely for use by technically qualified, professional electronics experts who are familiar with the dangers and application risks associated with handling electrical mechanical components, systems, and subsystems.

User shall operate the Evaluation Kit within TI's recommended guidelines and any applicable legal or environmental requirements as well as reasonable and customary safeguards. Failure to set up and/or operate the Evaluation Kit within TI's recommended guidelines may result in personal injury or death or property damage. Proper set up entails following TI's instructions for electrical ratings of interface circuits such as input, output and electrical loads.

NOTE:

EXPOSURE TO ELECTROSTATIC DISCHARGE (ESD) MAY CAUSE DEGRADATION OR FAILURE OF THE EVALUATION KIT; TI RECOMMENDS STORAGE OF THE EVALUATION KIT IN A PROTECTIVE ESD BAG.

3 Regulatory Notices:

3.1 United States

3.1.1 Notice applicable to EVMs not FCC-Approved:

FCC NOTICE: This kit is designed to allow product developers to evaluate electronic components, circuitry, or software associated with the kit to determine whether to incorporate such items in a finished product and software developers to write software applications for use with the end product. This kit is not a finished product and when assembled may not be resold or otherwise marketed unless all required FCC equipment authorizations are first obtained. Operation is subject to the condition that this product not cause harmful interference to licensed radio stations and that this product accept harmful interference. Unless the assembled kit is designed to operate under part 15, part 18 or part 95 of this chapter, the operator of the kit must operate under the authority of an FCC license holder or must secure an experimental authorization under part 5 of this chapter.

3.1.2 For EVMs annotated as FCC – FEDERAL COMMUNICATIONS COMMISSION Part 15 Compliant:

CAUTION

This device complies with part 15 of the FCC Rules. Operation is subject to the following two conditions: (1) This device may not cause harmful interference, and (2) this device must accept any interference received, including interference that may cause undesired operation.

Changes or modifications not expressly approved by the party responsible for compliance could void the user's authority to operate the equipment.

FCC Interference Statement for Class A EVM devices

NOTE: This equipment has been tested and found to comply with the limits for a Class A digital device, pursuant to part 15 of the FCC Rules. These limits are designed to provide reasonable protection against harmful interference when the equipment is operated in a commercial environment. This equipment generates, uses, and can radiate radio frequency energy and, if not installed and used in accordance with the instruction manual, may cause harmful interference to radio communications. Operation of this equipment in a residential area is likely to cause harmful interference in which case the user will be required to correct the interference at his own expense.

FCC Interference Statement for Class B EVM devices

NOTE: This equipment has been tested and found to comply with the limits for a Class B digital device, pursuant to part 15 of the FCC Rules. These limits are designed to provide reasonable protection against harmful interference in a residential installation. This equipment generates, uses and can radiate radio frequency energy and, if not installed and used in accordance with the instructions, may cause harmful interference to radio communications. However, there is no guarantee that interference will not occur in a particular installation. If this equipment does cause harmful interference to radio or television reception, which can be determined by turning the equipment off and on, the user is encouraged to try to correct the interference by one or more of the following measures:

- Reorient or relocate the receiving antenna.
- Increase the separation between the equipment and receiver.
- Connect the equipment into an outlet on a circuit different from that to which the receiver is connected.
- Consult the dealer or an experienced radio/TV technician for help.

3.2 Canada

3.2.1 For EVMs issued with an Industry Canada Certificate of Conformance to RSS-210 or RSS-247

Concerning EVMs Including Radio Transmitters:

This device complies with Industry Canada license-exempt RSSs. Operation is subject to the following two conditions:

(1) this device may not cause interference, and (2) this device must accept any interference, including interference that may cause undesired operation of the device.

Concernant les EVMs avec appareils radio:

Le présent appareil est conforme aux CNR d'Industrie Canada applicables aux appareils radio exempts de licence. L'exploitation est autorisée aux deux conditions suivantes: (1) l'appareil ne doit pas produire de brouillage, et (2) l'utilisateur de l'appareil doit accepter tout brouillage radioélectrique subi, même si le brouillage est susceptible d'en compromettre le fonctionnement.

Concerning EVMs Including Detachable Antennas:

Under Industry Canada regulations, this radio transmitter may only operate using an antenna of a type and maximum (or lesser) gain approved for the transmitter by Industry Canada. To reduce potential radio interference to other users, the antenna type and its gain should be so chosen that the equivalent isotropically radiated power (e.i.r.p.) is not more than that necessary for successful communication. This radio transmitter has been approved by Industry Canada to operate with the antenna types listed in the user guide with the maximum permissible gain and required antenna impedance for each antenna type indicated. Antenna types not included in this list, having a gain greater than the maximum gain indicated for that type, are strictly prohibited for use with this device.

Concernant les EVMs avec antennes détachables

Conformément à la réglementation d'Industrie Canada, le présent émetteur radio peut fonctionner avec une antenne d'un type et d'un gain maximal (ou inférieur) approuvé pour l'émetteur par Industrie Canada. Dans le but de réduire les risques de brouillage radioélectrique à l'intention des autres utilisateurs, il faut choisir le type d'antenne et son gain de sorte que la puissance isotrope rayonnée équivalente (p.i.r.e.) ne dépasse pas l'intensité nécessaire à l'établissement d'une communication satisfaisante. Le présent émetteur radio a été approuvé par Industrie Canada pour fonctionner avec les types d'antenne énumérés dans le manuel d'usage et ayant un gain admissible maximal et l'impédance requise pour chaque type d'antenne. Les types d'antenne non inclus dans cette liste, ou dont le gain est supérieur au gain maximal indiqué, sont strictement interdits pour l'exploitation de l'émetteur.

3.3 Japan

3.3.1 *Notice for EVMs delivered in Japan:* Please see http://www.tij.co.jp/lstds/ti_ja/general/eStore/notice_01.page 日本国内に輸入される評価用キット、ボードについては、次のところをご覧ください。
http://www.tij.co.jp/lstds/ti_ja/general/eStore/notice_01.page

3.3.2 *Notice for Users of EVMs Considered "Radio Frequency Products" in Japan:* EVMs entering Japan may not be certified by TI as conforming to Technical Regulations of Radio Law of Japan.

If User uses EVMs in Japan, not certified to Technical Regulations of Radio Law of Japan, User is required to follow the instructions set forth by Radio Law of Japan, which includes, but is not limited to, the instructions below with respect to EVMs (which for the avoidance of doubt are stated strictly for convenience and should be verified by User):

1. Use EVMs in a shielded room or any other test facility as defined in the notification #173 issued by Ministry of Internal Affairs and Communications on March 28, 2006, based on Sub-section 1.1 of Article 6 of the Ministry's Rule for Enforcement of Radio Law of Japan,
2. Use EVMs only after User obtains the license of Test Radio Station as provided in Radio Law of Japan with respect to EVMs, or
3. Use of EVMs only after User obtains the Technical Regulations Conformity Certification as provided in Radio Law of Japan with respect to EVMs. Also, do not transfer EVMs, unless User gives the same notice above to the transferee. Please note that if User does not follow the instructions above, User will be subject to penalties of Radio Law of Japan.

【無線電波を送信する製品の開発キットをお使いになる際の注意事項】 開発キットの中には技術基準適合証明を受けていないものがあります。技術適合証明を受けていないものご使用に際しては、電波法遵守のため、以下のいずれかの措置を取っていただく必要がありますのでご注意ください。

1. 電波法施行規則第6条第1項第1号に基づく平成18年3月28日総務省告示第173号で定められた電波暗室等の試験設備でご使用いただく。
2. 実験局の免許を取得後ご使用いただく。
3. 技術基準適合証明を取得後ご使用いただく。

なお、本製品は、上記の「ご使用にあたっての注意」を譲渡先、移転先に通知しない限り、譲渡、移転できないものとします。

上記を遵守頂けない場合は、電波法の罰則が適用される可能性があることをご留意ください。日本テキサス・インスツルメンツ株式会社
東京都新宿区西新宿 6 丁目 2 4 番 1 号
西新宿三井ビル

3.3.3 *Notice for EVMs for Power Line Communication:* Please see http://www.tij.co.jp/lstds/ti_ja/general/eStore/notice_02.page
電力線搬送波通信についての開発キットをお使いになる際の注意事項については、次のところをご覧ください。http://www.tij.co.jp/lstds/ti_ja/general/eStore/notice_02.page

3.4 European Union

3.4.1 *For EVMs subject to EU Directive 2014/30/EU (Electromagnetic Compatibility Directive):*

This is a class A product intended for use in environments other than domestic environments that are connected to a low-voltage power-supply network that supplies buildings used for domestic purposes. In a domestic environment this product may cause radio interference in which case the user may be required to take adequate measures.

4 *EVM Use Restrictions and Warnings:*

4.1 EVMS ARE NOT FOR USE IN FUNCTIONAL SAFETY AND/OR SAFETY CRITICAL EVALUATIONS, INCLUDING BUT NOT LIMITED TO EVALUATIONS OF LIFE SUPPORT APPLICATIONS.

4.2 User must read and apply the user guide and other available documentation provided by TI regarding the EVM prior to handling or using the EVM, including without limitation any warning or restriction notices. The notices contain important safety information related to, for example, temperatures and voltages.

4.3 *Safety-Related Warnings and Restrictions:*

4.3.1 User shall operate the EVM within TI's recommended specifications and environmental considerations stated in the user guide, other available documentation provided by TI, and any other applicable requirements and employ reasonable and customary safeguards. Exceeding the specified performance ratings and specifications (including but not limited to input and output voltage, current, power, and environmental ranges) for the EVM may cause personal injury or death, or property damage. If there are questions concerning performance ratings and specifications, User should contact a TI field representative prior to connecting interface electronics including input power and intended loads. Any loads applied outside of the specified output range may also result in unintended and/or inaccurate operation and/or possible permanent damage to the EVM and/or interface electronics. Please consult the EVM user guide prior to connecting any load to the EVM output. If there is uncertainty as to the load specification, please contact a TI field representative. During normal operation, even with the inputs and outputs kept within the specified allowable ranges, some circuit components may have elevated case temperatures. These components include but are not limited to linear regulators, switching transistors, pass transistors, current sense resistors, and heat sinks, which can be identified using the information in the associated documentation. When working with the EVM, please be aware that the EVM may become very warm.

4.3.2 EVMs are intended solely for use by technically qualified, professional electronics experts who are familiar with the dangers and application risks associated with handling electrical mechanical components, systems, and subsystems. User assumes all responsibility and liability for proper and safe handling and use of the EVM by User or its employees, affiliates, contractors or designees. User assumes all responsibility and liability to ensure that any interfaces (electronic and/or mechanical) between the EVM and any human body are designed with suitable isolation and means to safely limit accessible leakage currents to minimize the risk of electrical shock hazard. User assumes all responsibility and liability for any improper or unsafe handling or use of the EVM by User or its employees, affiliates, contractors or designees.

4.4 User assumes all responsibility and liability to determine whether the EVM is subject to any applicable international, federal, state, or local laws and regulations related to User's handling and use of the EVM and, if applicable, User assumes all responsibility and liability for compliance in all respects with such laws and regulations. User assumes all responsibility and liability for proper disposal and recycling of the EVM consistent with all applicable international, federal, state, and local requirements.

5. *Accuracy of Information:* To the extent TI provides information on the availability and function of EVMs, TI attempts to be as accurate as possible. However, TI does not warrant the accuracy of EVM descriptions, EVM availability or other information on its websites as accurate, complete, reliable, current, or error-free.

6. *Disclaimers:*

6.1 EXCEPT AS SET FORTH ABOVE, EVMS AND ANY MATERIALS PROVIDED WITH THE EVM (INCLUDING, BUT NOT LIMITED TO, REFERENCE DESIGNS AND THE DESIGN OF THE EVM ITSELF) ARE PROVIDED "AS IS" AND "WITH ALL FAULTS." TI DISCLAIMS ALL OTHER WARRANTIES, EXPRESS OR IMPLIED, REGARDING SUCH ITEMS, INCLUDING BUT NOT LIMITED TO ANY EPIDEMIC FAILURE WARRANTY OR IMPLIED WARRANTIES OF MERCHANTABILITY OR FITNESS FOR A PARTICULAR PURPOSE OR NON-INFRINGEMENT OF ANY THIRD PARTY PATENTS, COPYRIGHTS, TRADE SECRETS OR OTHER INTELLECTUAL PROPERTY RIGHTS.

6.2 EXCEPT FOR THE LIMITED RIGHT TO USE THE EVM SET FORTH HEREIN, NOTHING IN THESE TERMS SHALL BE CONSTRUED AS GRANTING OR CONFERRING ANY RIGHTS BY LICENSE, PATENT, OR ANY OTHER INDUSTRIAL OR INTELLECTUAL PROPERTY RIGHT OF TI, ITS SUPPLIERS/LICENSORS OR ANY OTHER THIRD PARTY, TO USE THE EVM IN ANY FINISHED END-USER OR READY-TO-USE FINAL PRODUCT, OR FOR ANY INVENTION, DISCOVERY OR IMPROVEMENT, REGARDLESS OF WHEN MADE, CONCEIVED OR ACQUIRED.

7. *USER'S INDEMNITY OBLIGATIONS AND REPRESENTATIONS.* USER WILL DEFEND, INDEMNIFY AND HOLD TI, ITS LICENSORS AND THEIR REPRESENTATIVES HARMLESS FROM AND AGAINST ANY AND ALL CLAIMS, DAMAGES, LOSSES, EXPENSES, COSTS AND LIABILITIES (COLLECTIVELY, "CLAIMS") ARISING OUT OF OR IN CONNECTION WITH ANY HANDLING OR USE OF THE EVM THAT IS NOT IN ACCORDANCE WITH THESE TERMS. THIS OBLIGATION SHALL APPLY WHETHER CLAIMS ARISE UNDER STATUTE, REGULATION, OR THE LAW OF TORT, CONTRACT OR ANY OTHER LEGAL THEORY, AND EVEN IF THE EVM FAILS TO PERFORM AS DESCRIBED OR EXPECTED.

8. *Limitations on Damages and Liability:*

8.1 *General Limitations.* IN NO EVENT SHALL TI BE LIABLE FOR ANY SPECIAL, COLLATERAL, INDIRECT, PUNITIVE, INCIDENTAL, CONSEQUENTIAL, OR EXEMPLARY DAMAGES IN CONNECTION WITH OR ARISING OUT OF THESE TERMS OR THE USE OF THE EVMS , REGARDLESS OF WHETHER TI HAS BEEN ADVISED OF THE POSSIBILITY OF SUCH DAMAGES. EXCLUDED DAMAGES INCLUDE, BUT ARE NOT LIMITED TO, COST OF REMOVAL OR REINSTALLATION, ANCILLARY COSTS TO THE PROCUREMENT OF SUBSTITUTE GOODS OR SERVICES, RETESTING, OUTSIDE COMPUTER TIME, LABOR COSTS, LOSS OF GOODWILL, LOSS OF PROFITS, LOSS OF SAVINGS, LOSS OF USE, LOSS OF DATA, OR BUSINESS INTERRUPTION. NO CLAIM, SUIT OR ACTION SHALL BE BROUGHT AGAINST TI MORE THAN TWELVE (12) MONTHS AFTER THE EVENT THAT GAVE RISE TO THE CAUSE OF ACTION HAS OCCURRED.

8.2 *Specific Limitations.* IN NO EVENT SHALL TI'S AGGREGATE LIABILITY FROM ANY USE OF AN EVM PROVIDED HEREUNDER, INCLUDING FROM ANY WARRANTY, INDEMNITY OR OTHER OBLIGATION ARISING OUT OF OR IN CONNECTION WITH THESE TERMS, , EXCEED THE TOTAL AMOUNT PAID TO TI BY USER FOR THE PARTICULAR EVM(S) AT ISSUE DURING THE PRIOR TWELVE (12) MONTHS WITH RESPECT TO WHICH LOSSES OR DAMAGES ARE CLAIMED. THE EXISTENCE OF MORE THAN ONE CLAIM SHALL NOT ENLARGE OR EXTEND THIS LIMIT.

9. *Return Policy.* Except as otherwise provided, TI does not offer any refunds, returns, or exchanges. Furthermore, no return of EVM(s) will be accepted if the package has been opened and no return of the EVM(s) will be accepted if they are damaged or otherwise not in a resalable condition. If User feels it has been incorrectly charged for the EVM(s) it ordered or that delivery violates the applicable order, User should contact TI. All refunds will be made in full within thirty (30) working days from the return of the components(s), excluding any postage or packaging costs.

10. *Governing Law:* These terms and conditions shall be governed by and interpreted in accordance with the laws of the State of Texas, without reference to conflict-of-laws principles. User agrees that non-exclusive jurisdiction for any dispute arising out of or relating to these terms and conditions lies within courts located in the State of Texas and consents to venue in Dallas County, Texas. Notwithstanding the foregoing, any judgment may be enforced in any United States or foreign court, and TI may seek injunctive relief in any United States or foreign court.

Mailing Address: Texas Instruments, Post Office Box 655303, Dallas, Texas 75265
Copyright © 2019, Texas Instruments Incorporated

IMPORTANT NOTICE AND DISCLAIMER

TI PROVIDES TECHNICAL AND RELIABILITY DATA (INCLUDING DATA SHEETS), DESIGN RESOURCES (INCLUDING REFERENCE DESIGNS), APPLICATION OR OTHER DESIGN ADVICE, WEB TOOLS, SAFETY INFORMATION, AND OTHER RESOURCES "AS IS" AND WITH ALL FAULTS, AND DISCLAIMS ALL WARRANTIES, EXPRESS AND IMPLIED, INCLUDING WITHOUT LIMITATION ANY IMPLIED WARRANTIES OF MERCHANTABILITY, FITNESS FOR A PARTICULAR PURPOSE OR NON-INFRINGEMENT OF THIRD PARTY INTELLECTUAL PROPERTY RIGHTS.

These resources are intended for skilled developers designing with TI products. You are solely responsible for (1) selecting the appropriate TI products for your application, (2) designing, validating and testing your application, and (3) ensuring your application meets applicable standards, and any other safety, security, regulatory or other requirements.

These resources are subject to change without notice. TI grants you permission to use these resources only for development of an application that uses the TI products described in the resource. Other reproduction and display of these resources is prohibited. No license is granted to any other TI intellectual property right or to any third party intellectual property right. TI disclaims responsibility for, and you will fully indemnify TI and its representatives against, any claims, damages, costs, losses, and liabilities arising out of your use of these resources.

TI's products are provided subject to [TI's Terms of Sale](#) or other applicable terms available either on ti.com or provided in conjunction with such TI products. TI's provision of these resources does not expand or otherwise alter TI's applicable warranties or warranty disclaimers for TI products.

TI objects to and rejects any additional or different terms you may have proposed.

Mailing Address: Texas Instruments, Post Office Box 655303, Dallas, Texas 75265
Copyright © 2022, Texas Instruments Incorporated