

Highly insulated module with Trench/Fieldstop IGBT3 and emitter controlled 3 diode

Features

- Electrical features
 - $V_{CES} = 6500\text{ V}$
 - $I_{C\text{nom}} = 250\text{ A} / I_{CRM} = 500\text{ A}$
 - LOW $V_{CE,sat}$
- Mechanical features
 - ALSiC base plate for increased thermal cycling capability
 - Extended storage temperature down to $T_{stg} = -55\text{ °C}$
 - High creepage and clearance distances
 - Package with enhanced insulation of 10.4 kV AC 60 s
 - Package with CTI > 600



Potential applications

- Traction drives
- Medium-voltage converters

Product validation

- Qualified for industrial applications according to the relevant tests of IEC 60747, 60749 and 60068

Description

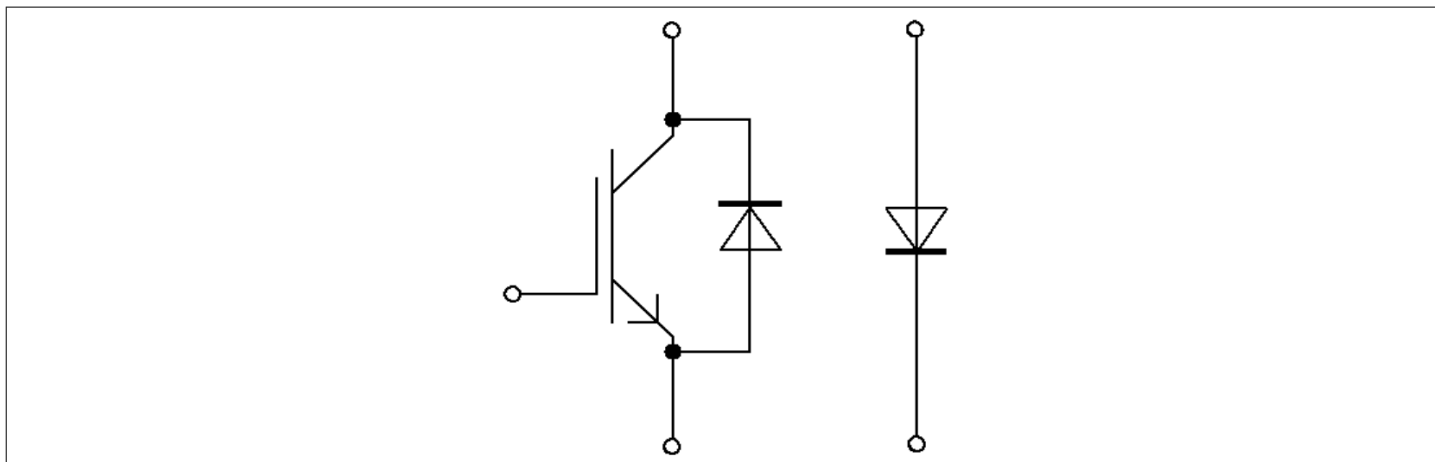

Table of contents

	Description	1
	Features	1
	Potential applications	1
	Product validation	1
	Table of contents	2
1	Package	3
2	IGBT, Inverter	3
3	Diode, Inverter	5
4	Diode, Brake-Chopper	6
5	Characteristics diagrams	8
6	Circuit diagram	13
7	Package outlines	14
8	Module label code	15
	Revision history	16
	Disclaimer	17

1 Package

Table 1 Insulation coordination

Parameter	Symbol	Note or test condition	Values	Unit
Isolation test voltage	V_{ISOL}	RMS, $f = 50 \text{ Hz}$, $t = 60 \text{ s}$	10.4	kV
Partial discharge extinction voltage	V_{isol}	RMS, $f = 50 \text{ Hz}$, Q_{PD} typ. 10 pC	5.1	kV
DC stability	$V_{CE(D)}$	$T_{vj}=25^{\circ}\text{C}$, 100 Fit	3800	V
Material of module baseplate			AlSiC	
Internal isolation		basic insulation (class 1, IEC 61140)	AlN	
Creepage distance	d_{Creep}	terminal to heatsink	64.0	mm
Creepage distance	d_{Creep}	terminal to terminal	56.0	mm
Clearance	d_{Clear}	terminal to heatsink	40.0	mm
Clearance	d_{Clear}	terminal to terminal	26.0	mm
Comparative tracking index	CTI		>600	

Table 2 Characteristic values

Parameter	Symbol	Note or test condition	Values			Unit	
			Min.	Typ.	Max.		
Stray inductance module	L_{sCE}			25		nH	
Module lead resistance, terminals - chip	$R_{AA'+CC'}$	$T_C=25^{\circ}\text{C}$, per switch		0.36		mΩ	
Module lead resistance, terminals - chip	$R_{CC'+EE'}$	$T_C=25^{\circ}\text{C}$, per switch		0.36		mΩ	
Storage temperature	T_{stg}		-55		125	°C	
Mounting torque for module mounting	M	- Mounting according to valid application note	M6, Screw	4.25		5.75	Nm
Terminal connection torque	M	- Mounting according to valid application note	M4, Screw	1.8		2.1	Nm
			M8, Screw	8		10	
Weight	G			1000		g	

2 IGBT, Inverter

Table 3 Maximum rated values

Parameter	Symbol	Note or test condition	Values	Unit	
Collector-emitter voltage	V_{CES}		$T_{vj} = -50^{\circ}\text{C}$	5900	V
			$T_{vj} = 25^{\circ}\text{C}$	6500	
			$T_{vj} = 125^{\circ}\text{C}$	6500	

(table continues...)

Table 3 (continued) Maximum rated values

Parameter	Symbol	Note or test condition	Values	Unit
Continuous DC collector current	I_{CDC}	$T_{vj\ max} = 150\ ^\circ\text{C}$ $T_C = 80\ ^\circ\text{C}$	250	A
Repetitive peak collector current	I_{CRM}	$t_P = 1\ \text{ms}$	500	A
Gate-emitter peak voltage	V_{GES}		± 20	V

Table 4 Characteristic values

Parameter	Symbol	Note or test condition	Values			Unit
			Min.	Typ.	Max.	
Collector-emitter saturation voltage	$V_{CE\ sat}$	$I_C = 250\ \text{A}, V_{GE} = 15\ \text{V}$	$T_{vj} = 25\ ^\circ\text{C}$	3.00	3.40	V
			$T_{vj} = 125\ ^\circ\text{C}$	3.70	4.20	
Gate threshold voltage	V_{GEth}	$I_C = 35\ \text{mA}, V_{CE} = V_{GE}, T_{vj} = 25\ ^\circ\text{C}$	5.40	6	6.60	V
Gate charge	Q_G	$V_{GE} = \pm 15\ \text{V}, V_{CE} = 3600\ \text{V}$		10		μC
Internal gate resistor	R_{Gint}	$T_{vj} = 25\ ^\circ\text{C}$		2.3		Ω
Input capacitance	C_{ies}	$f = 1000\ \text{kHz}, T_{vj} = 25\ ^\circ\text{C}, V_{CE} = 25\ \text{V}, V_{GE} = 0\ \text{V}$		69		nF
Reverse transfer capacitance	C_{res}	$f = 1000\ \text{kHz}, T_{vj} = 25\ ^\circ\text{C}, V_{CE} = 25\ \text{V}, V_{GE} = 0\ \text{V}$		1.05		nF
Collector-emitter cut-off current	I_{CES}	$V_{CE} = 6500\ \text{V}, V_{GE} = 0\ \text{V}$ $T_{vj} = 25\ ^\circ\text{C}$			5	mA
Gate-emitter leakage current	I_{GES}	$V_{CE} = 0\ \text{V}, V_{GE} = 20\ \text{V}, T_{vj} = 25\ ^\circ\text{C}$			400	nA
Turn-on delay time (inductive load)	t_{don}	$I_C = 250\ \text{A}, V_{CE} = 3600\ \text{V}, V_{GE} = \pm 15\ \text{V}, R_{Gon} = 3\ \Omega$	$T_{vj} = 25\ ^\circ\text{C}$	0.640		μs
			$T_{vj} = 125\ ^\circ\text{C}$	0.650		
Rise time (inductive load)	t_r	$I_C = 250\ \text{A}, V_{CE} = 3600\ \text{V}, V_{GE} = \pm 15\ \text{V}, R_{Gon} = 3\ \Omega$	$T_{vj} = 25\ ^\circ\text{C}$	0.180		μs
			$T_{vj} = 125\ ^\circ\text{C}$	0.200		
Turn-off delay time (inductive load)	t_{doff}	$I_C = 250\ \text{A}, V_{CE} = 3600\ \text{V}, V_{GE} = \pm 15\ \text{V}, R_{Goff} = 20\ \Omega$	$T_{vj} = 25\ ^\circ\text{C}$	7.300		μs
			$T_{vj} = 125\ ^\circ\text{C}$	7.600		
Fall time (inductive load)	t_f	$I_C = 250\ \text{A}, V_{CE} = 3600\ \text{V}, V_{GE} = \pm 15\ \text{V}, R_{Goff} = 20\ \Omega$	$T_{vj} = 25\ ^\circ\text{C}$	0.400		μs
			$T_{vj} = 125\ ^\circ\text{C}$	0.500		
Turn-on time (resistive load)	t_{on_R}	$I_C = 500\ \text{A}, V_{CE} = 2000\ \text{V}, V_{GE} = \pm 15\ \text{V}, R_{Gon} = 3\ \Omega$	1.91			μs
Turn-on energy loss per pulse	E_{on}	$I_C = 250\ \text{A}, V_{CE} = 3600\ \text{V}, L_\sigma = 280\ \text{nH}, V_{GE} = \pm 15\ \text{V}, R_{Gon} = 3\ \Omega$	$T_{vj} = 25\ ^\circ\text{C}$	1400		mJ
			$T_{vj} = 125\ ^\circ\text{C}$	2200		
Turn-off energy loss per pulse	E_{off}	$I_C = 250\ \text{A}, V_{CE} = 3600\ \text{V}, L_\sigma = 280\ \text{nH}, V_{GE} = \pm 15\ \text{V}, R_{Goff} = 20\ \Omega$	$T_{vj} = 25\ ^\circ\text{C}$	1200		mJ
			$T_{vj} = 125\ ^\circ\text{C}$	1400		
SC data	I_{SC}	$V_{GE} \leq 15\ \text{V}, V_{CC} = 4500\ \text{V}, V_{CEmax} = V_{CES} - L_{sCE} \cdot di/dt$	$t_P \leq 10\ \mu\text{s}, T_{vj} \leq 125\ ^\circ\text{C}$	1500		A

(table continues...)

Table 4 (continued) Characteristic values

Parameter	Symbol	Note or test condition	Values			Unit
			Min.	Typ.	Max.	
Thermal resistance, junction to case	R_{thJC}	per IGBT			26.1	K/kW
Thermal resistance, case to heat sink	R_{thCH}	per IGBT, $\lambda_{grease} = 1 \text{ W}/(\text{m}^2\text{K})$		26.4		K/kW
Temperature under switching conditions	$T_{vj\text{op}}$		-50		125	°C

3 Diode, Inverter

Table 5 Maximum rated values

Parameter	Symbol	Note or test condition	Values	Unit	
Repetitive peak reverse voltage	V_{RRM}		$T_{vj} = -50 \text{ °C}$	5900	V
			$T_{vj} = 25 \text{ °C}$	6500	
			$T_{vj} = 125 \text{ °C}$	6500	
Continuous DC forward current	I_F		250	A	
Repetitive peak forward current	I_{FRM}	$t_P = 1 \text{ ms}$	500	A	
I^2t - value	I^2t	$t_P = 10 \text{ ms}, V_R = 0 \text{ V}$	$T_{vj} = 125 \text{ °C}$	52	kA^2s
Maximum power dissipation	P_{RQM}	$T_{vj} = 125 \text{ °C}$	1000	kW	
Minimum turn-on time	t_{onmin}		10	μs	

Table 6 Characteristic values

Parameter	Symbol	Note or test condition	Values			Unit	
			Min.	Typ.	Max.		
Forward voltage	V_F	$I_F = 250 \text{ A}, V_{GE} = 0 \text{ V}$	$T_{vj} = 25 \text{ °C}$		3.00	3.50	V
			$T_{vj} = 125 \text{ °C}$		2.95	3.50	
Peak reverse recovery current	I_{RM}	$V_R = 3600 \text{ V}, I_F = 250 \text{ A}, V_{GE} = -15 \text{ V}, -di_F/dt = 1000 \text{ A}/\mu\text{s} (T_{vj} = 125 \text{ °C})$	$T_{vj} = 25 \text{ °C}$		370		A
			$T_{vj} = 125 \text{ °C}$		400		
Recovered charge	Q_r	$V_R = 3600 \text{ V}, I_F = 250 \text{ A}, V_{GE} = -15 \text{ V}, -di_F/dt = 1000 \text{ A}/\mu\text{s} (T_{vj} = 125 \text{ °C})$	$T_{vj} = 25 \text{ °C}$		290		μC
			$T_{vj} = 125 \text{ °C}$		540		
Reverse recovery energy	E_{rec}	$V_R = 3600 \text{ V}, I_F = 250 \text{ A}, V_{GE} = -15 \text{ V}, -di_F/dt = 1000 \text{ A}/\mu\text{s} (T_{vj} = 125 \text{ °C})$	$T_{vj} = 25 \text{ °C}$		470		mJ
			$T_{vj} = 125 \text{ °C}$		1000		

(table continues...)

Table 6 (continued) Characteristic values

Parameter	Symbol	Note or test condition	Values			Unit
			Min.	Typ.	Max.	
Thermal resistance, junction to case	R_{thJC}	per diode			55.8	K/kW
Thermal resistance, case to heat sink	R_{thCH}	per diode, $\lambda_{grease} = 1 \text{ W}/(\text{m}^2\text{K})$		42.0		K/kW
Temperature under switching conditions	$T_{vj\text{op}}$		-50		125	°C

4 Diode, Brake-Chopper

Table 7 Maximum rated values

Parameter	Symbol	Note or test condition	Values	Unit	
Repetitive peak reverse voltage	V_{RRM}		$T_{vj} = -50 \text{ °C}$	5900	V
			$T_{vj} = 25 \text{ °C}$	6500	
			$T_{vj} = 125 \text{ °C}$	6500	
Continuous DC forward current	I_F		250	A	
Repetitive peak forward current	I_{FRM}	$t_P = 1 \text{ ms}$	500	A	
I^2t - value	I^2t	$t_P = 10 \text{ ms}, V_R = 0 \text{ V}$	$T_{vj} = 125 \text{ °C}$	52	kA ² s
Maximum power dissipation	P_{RQM}	$T_{vj} = 125 \text{ °C}$	1000	kW	
Minimum turn-on time	t_{onmin}		10	µs	

Table 8 Characteristic values

Parameter	Symbol	Note or test condition	Values			Unit
			Min.	Typ.	Max.	
Forward voltage	V_F	$I_F = 250 \text{ A}, V_{GE} = 0 \text{ V}$	$T_{vj} = 25 \text{ °C}$	3.00	3.50	V
			$T_{vj} = 125 \text{ °C}$		2.95	
Peak reverse recovery current	I_{RM}	$V_R = 3600 \text{ V}, I_F = 250 \text{ A}, V_{GE} = -15 \text{ V}, -di_F/dt = 1000 \text{ A}/\mu\text{s} (T_{vj} = 125 \text{ °C})$	$T_{vj} = 25 \text{ °C}$	370		A
			$T_{vj} = 125 \text{ °C}$	400		
Recovered charge	Q_r	$V_R = 3600 \text{ V}, I_F = 250 \text{ A}, V_{GE} = -15 \text{ V}, -di_F/dt = 1000 \text{ A}/\mu\text{s} (T_{vj} = 125 \text{ °C})$	$T_{vj} = 25 \text{ °C}$	290		µC
			$T_{vj} = 125 \text{ °C}$	540		
Reverse recovery energy	E_{rec}	$V_R = 3600 \text{ V}, I_F = 250 \text{ A}, V_{GE} = -15 \text{ V}, -di_F/dt = 1000 \text{ A}/\mu\text{s} (T_{vj} = 125 \text{ °C})$	$T_{vj} = 25 \text{ °C}$	470		mJ
			$T_{vj} = 125 \text{ °C}$	1000		

(table continues...)

Table 8 (continued) Characteristic values

Parameter	Symbol	Note or test condition	Values			Unit
			Min.	Typ.	Max.	
Thermal resistance, junction to case	R_{thJC}	per diode			55.8	K/kW
Thermal resistance, case to heat sink	R_{thCH}	per diode, $\lambda_{grease} = 1 \text{ W/(m}^2\text{K)}$		42.0		K/kW
Temperature under switching conditions	$T_{vj op}$		-50		125	°C

5 Characteristics diagrams

output characteristic (typical), IGBT, Inverter

$I_C = f(V_{CE})$
 $V_{GE} = 15 \text{ V}$

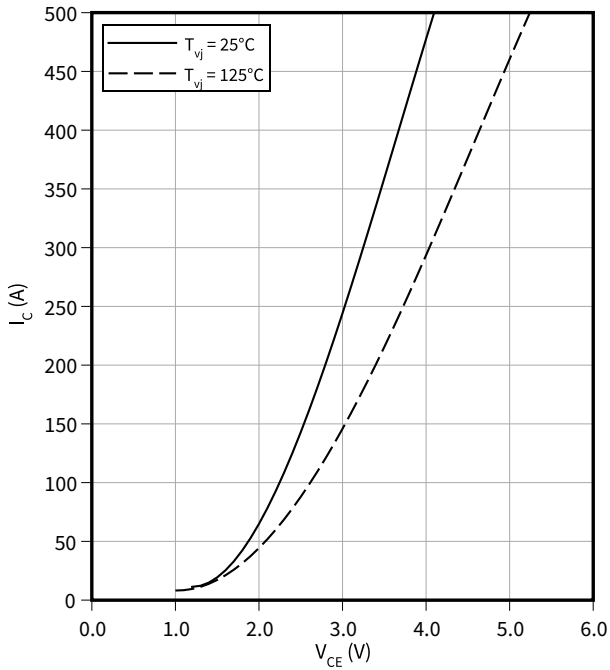

output characteristic (typical), IGBT, Inverter

$I_C = f(V_{CE})$
 $T_{vj} = 125 \text{ °C}$

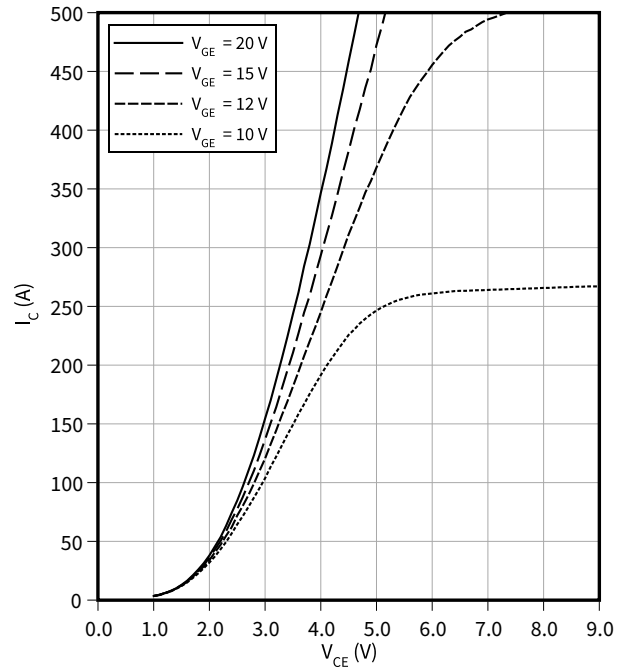

transfer characteristic (typical), IGBT, Inverter

$I_C = f(V_{GE})$
 $V_{CE} = 20 \text{ V}$

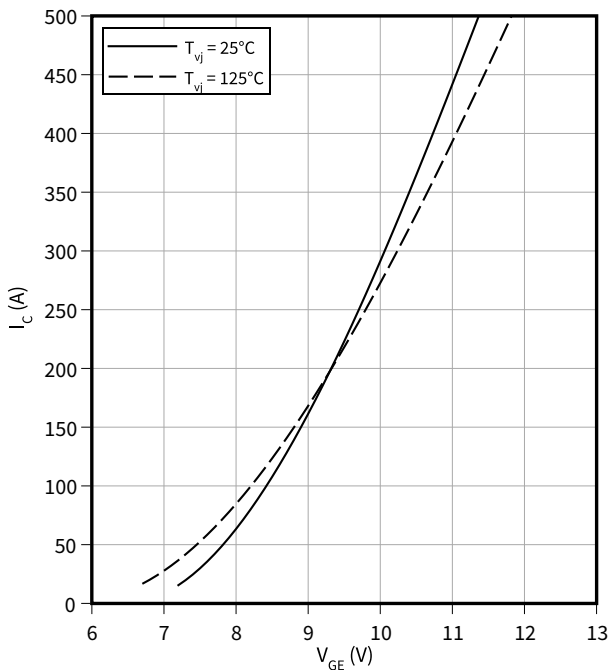

switching losses (typical), IGBT, Inverter

$E = f(I_C)$
 $R_{Goff} = 20 \text{ } \Omega$, $R_{Gon} = 3 \text{ } \Omega$, $V_{CE} = 3600 \text{ V}$, $V_{GE} = \pm 15 \text{ V}$

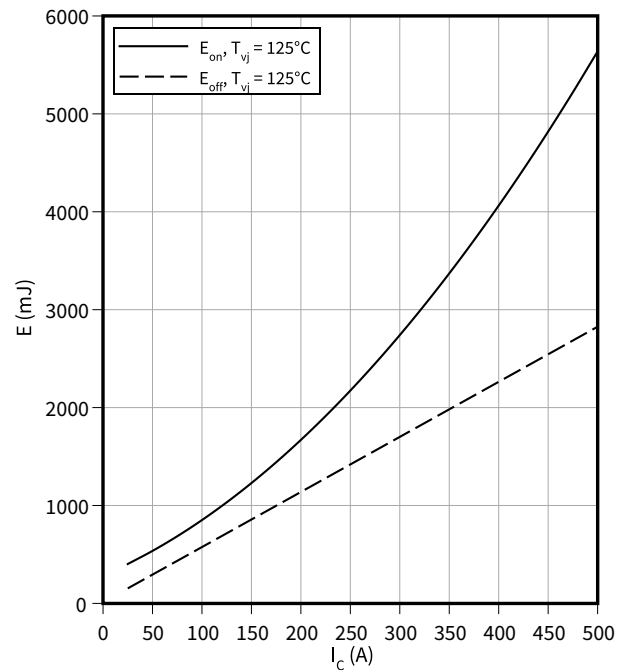

switching losses (typical), IGBT, Inverter

$E = f(R_G)$

$I_C = 250 \text{ A}$, $V_{CE} = 3600 \text{ V}$, $V_{GE} = \pm 15 \text{ V}$

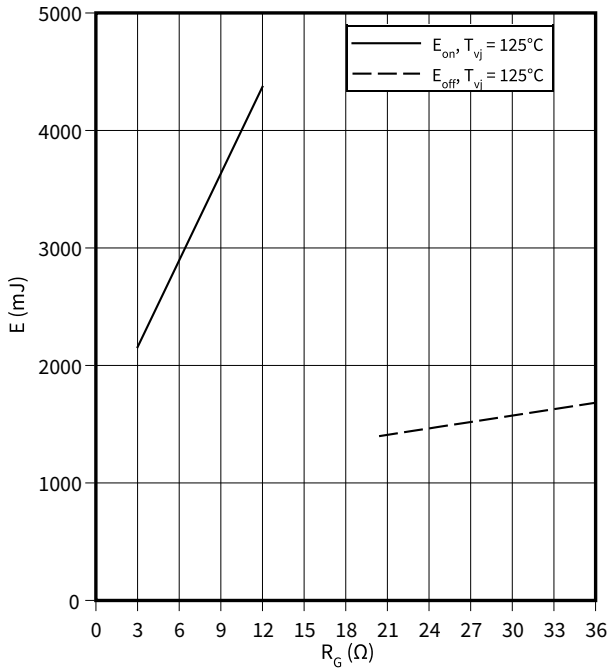

transient thermal impedance , IGBT, Inverter

$Z_{th} = f(t)$

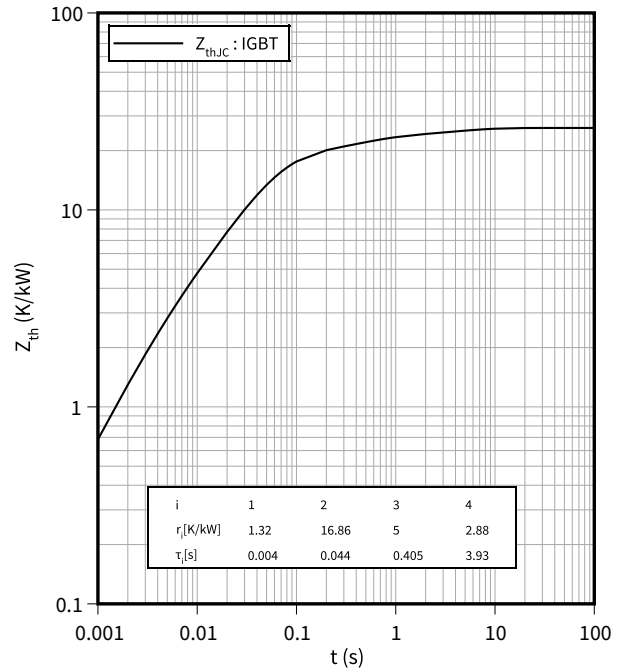

reverse bias safe operating area (RBSOA), IGBT, Inverter

$I_C = f(V_{CE})$

$R_{Goff} = 20 \Omega$, $V_{GE} = \pm 15 \text{ V}$

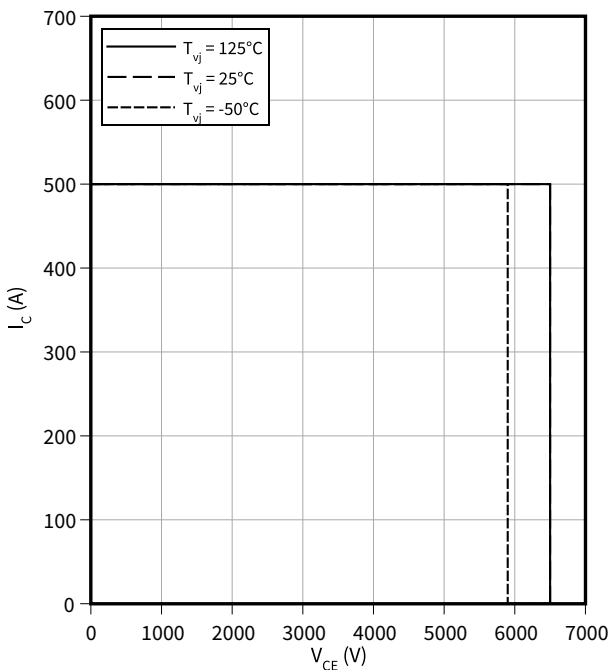

forward characteristic of (typical), Diode, Inverter

$I_F = f(V_F)$

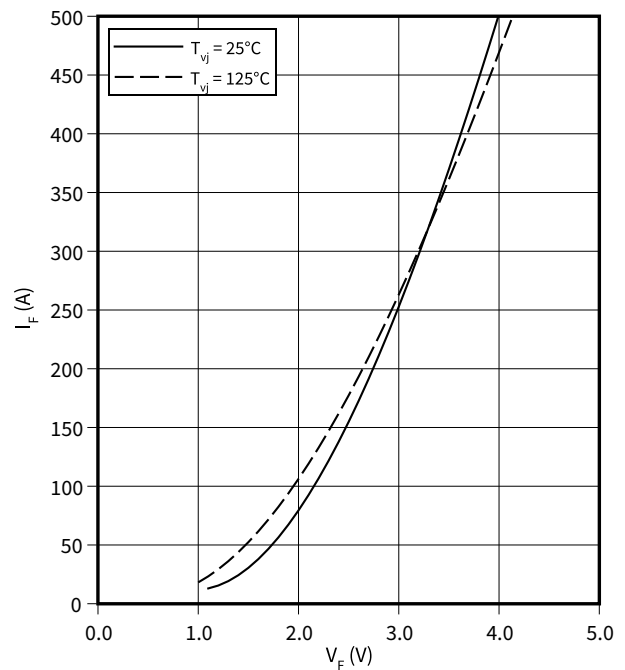

5 Characteristics diagrams

switching losses (typical), Diode, Inverter

$E_{rec} = f(I_F)$

$V_{CE} = 3600\text{ V}, R_{Gon} = R_{Gon}(IGBT)$

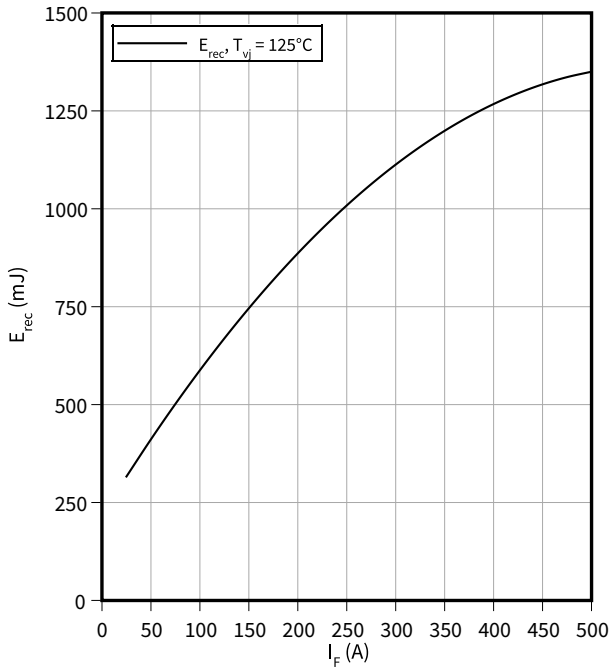

switching losses (typical), Diode, Inverter

$E_{rec} = f(R_G)$

$V_{CE} = 3600\text{ V}, I_F = 250\text{ A}$

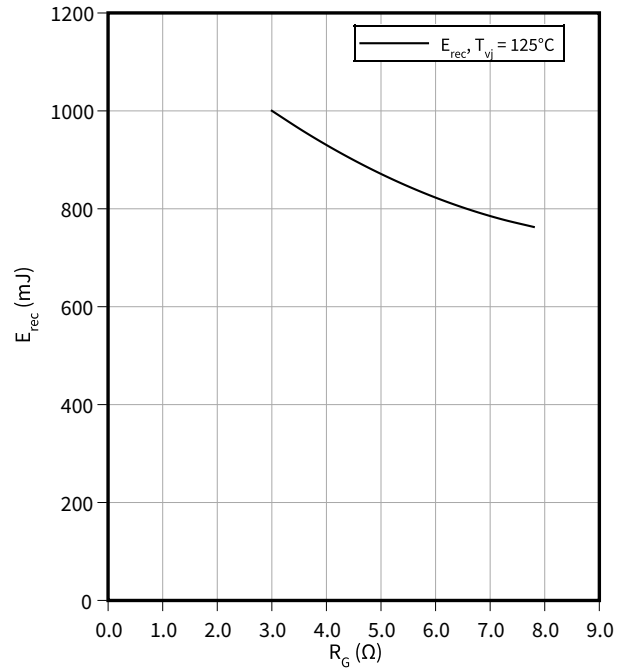

transient thermal impedance , Diode, Inverter

$Z_{th} = f(t)$

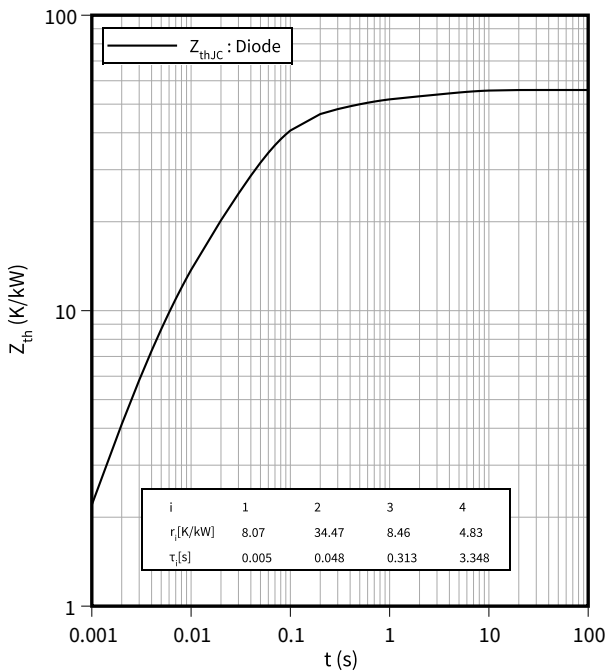

safe operation area (SOA), Diode, Inverter

$I_R = f(V_R)$

$T_{vj} = 125\text{ °C}$

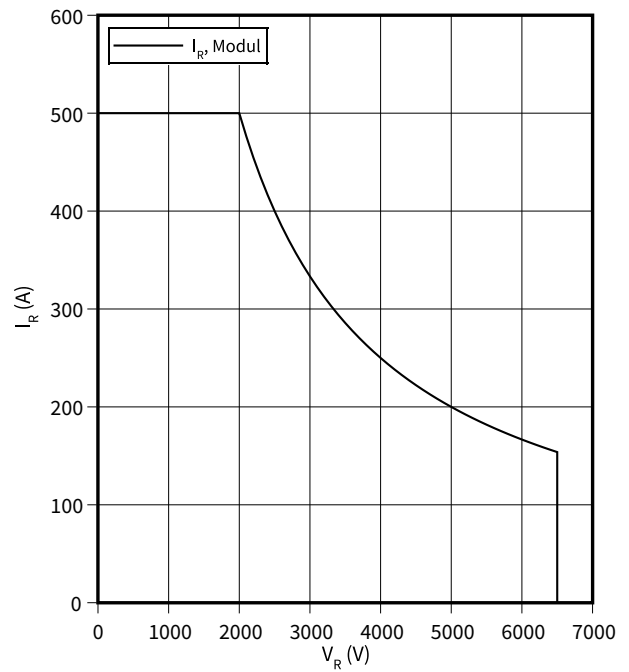

5 Characteristics diagrams

forward characteristic of (typical), Diode, Brake-Chopper

$I_F = f(V_F)$

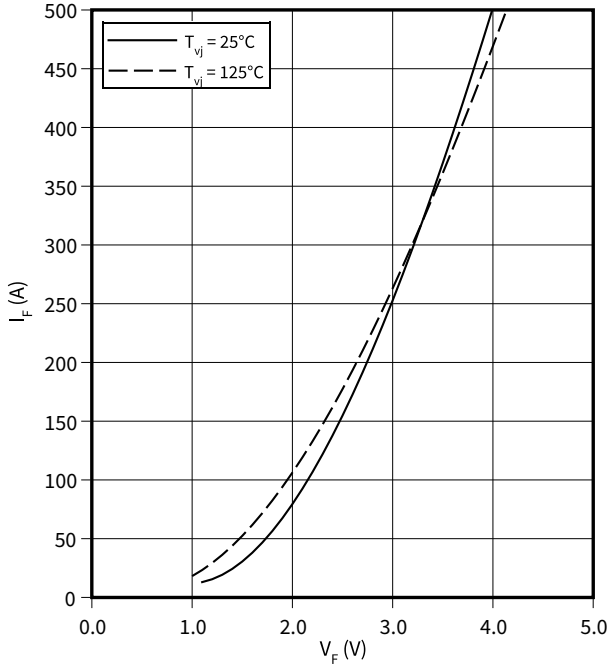

switching losses (typical), Diode, Brake-Chopper

$E_{rec} = f(I_F)$

$V_{CE} = 3600 \text{ V}, R_{Gon} = R_{Gon}(IGBT)$

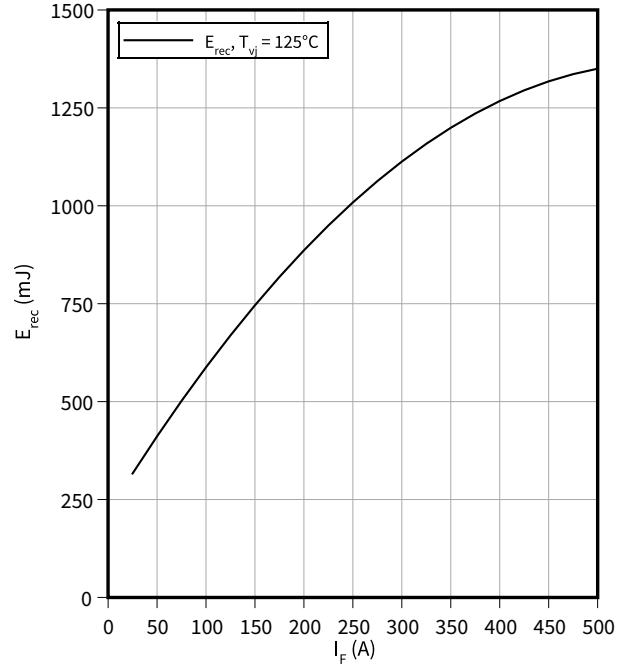

switching losses (typical), Diode, Brake-Chopper

$E_{rec} = f(R_G)$

$V_{CE} = 3600 \text{ V}, I_F = 250 \text{ A}$

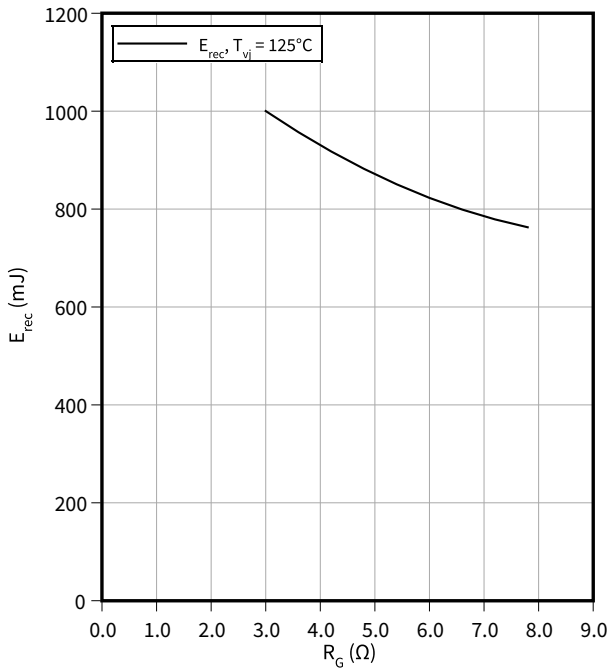

transient thermal impedance, Diode, Brake-Chopper

$Z_{th} = f(t)$

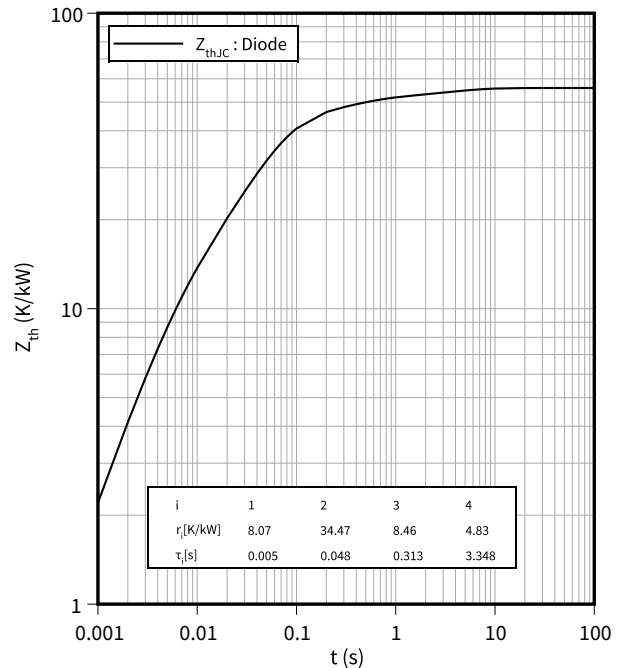

safe operation area (SOA), Diode, Brake-Chopper

$$I_R = f(V_R)$$

$$T_{vj} = 125\text{ °C}$$

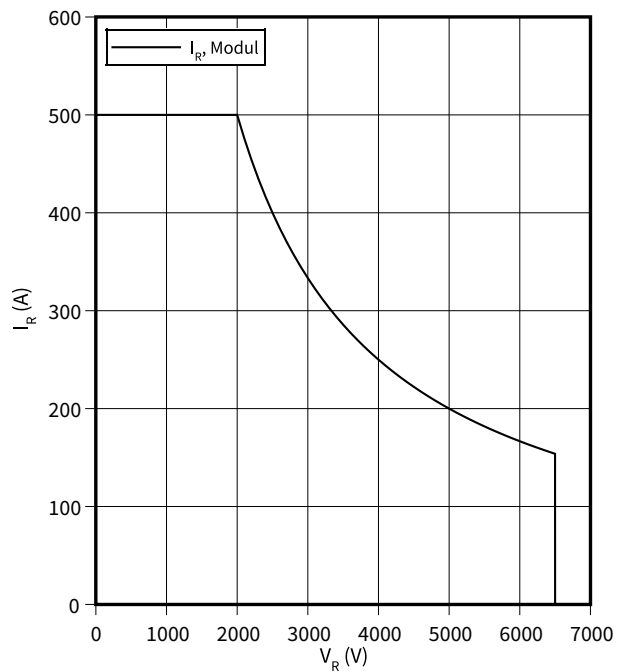

6 Circuit diagram

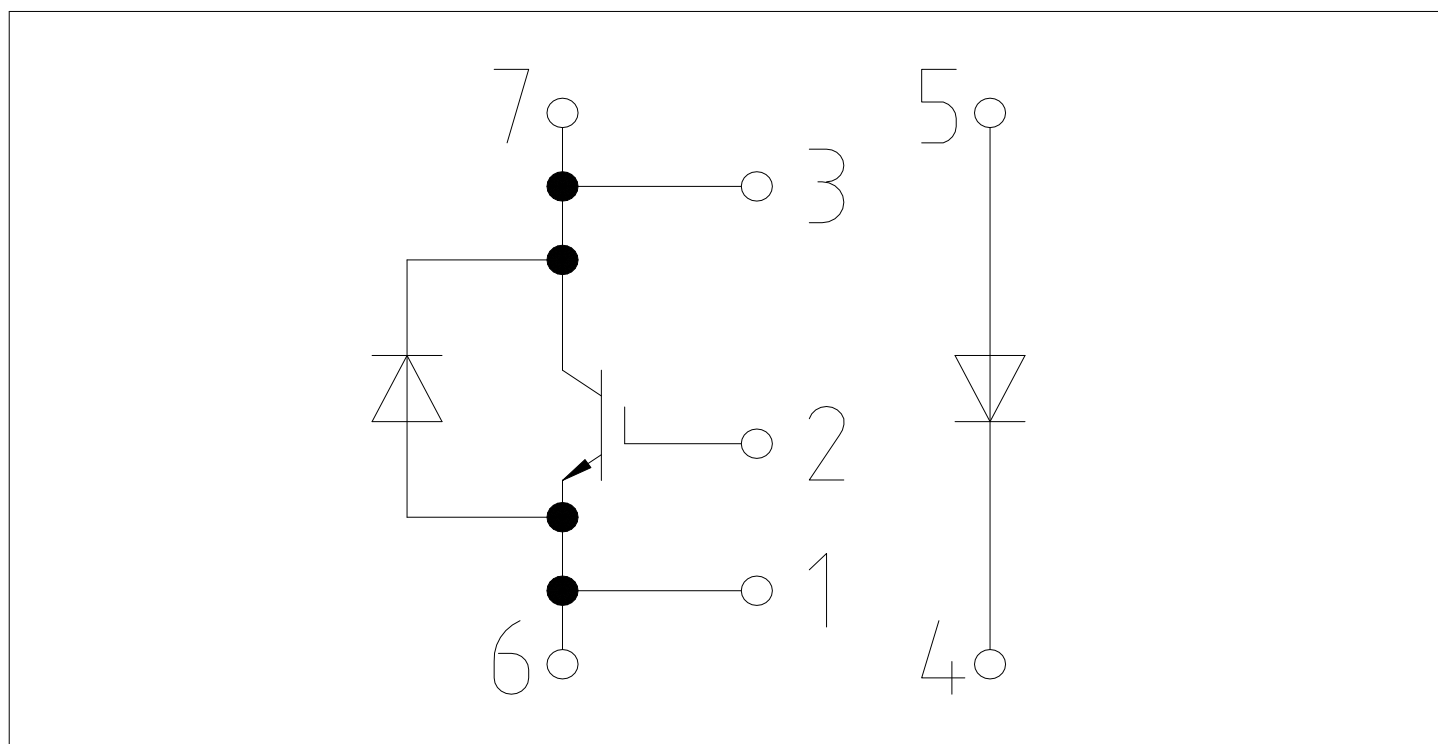

Figure 1

7 Package outlines

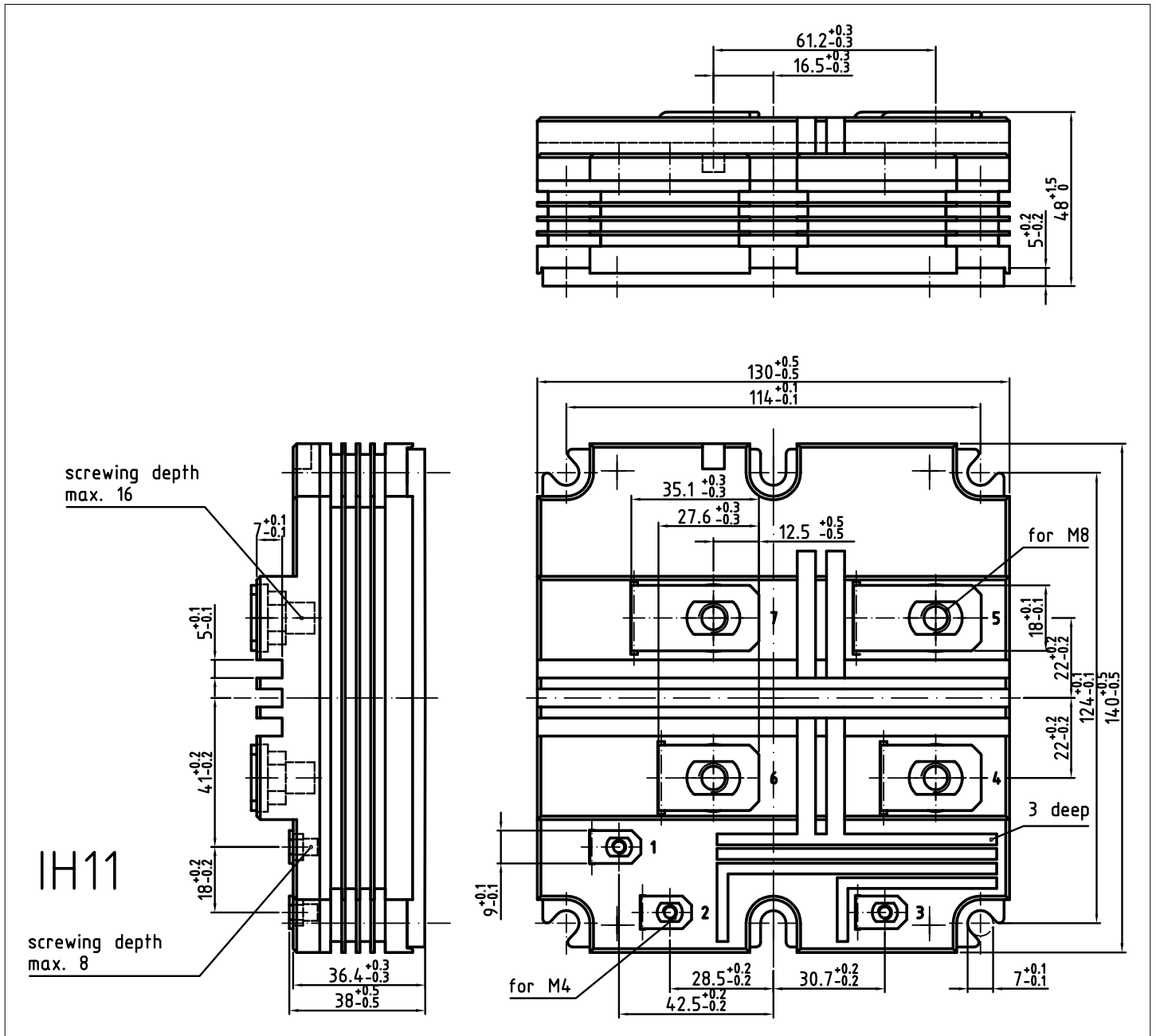

Figure 2

8 Module label code



Module label code			
Code format	Data Matrix	Barcode Code128	
Encoding	ASCII text	Code Set A	
Symbol size	16x16	23 digits	
Standard	IEC24720 and IEC16022	IEC8859-1	
Code content	<i>Content</i>	<i>Digit</i>	<i>Example</i>
	Module serial number	1 - 5	71549
	Module material number	6 - 11	142846
	Production order number	12 - 19	55054991
	Date code (production year)	20 - 21	15
	Date code (production week)	22 - 23	30
Example	 		
	71549142846550549911530		71549142846550549911530

Figure 3

Revision history

Document revision	Date of release	Description of changes
V1.0	2012-07-13	Target datasheet
V2.0	2012-07-16	Preliminary datasheet
V2.1	2012-12-03	Preliminary datasheet
V3.0	2014-06-16	Final datasheet
V3.1	2018-01-15	Final datasheet
V3.2	2019-09-06	Final datasheet
V3.3	2020-05-06	Final datasheet
n/a	2020-09-01	Datasheet migrated to a new system with a new layout and new revision number schema: target or preliminary datasheet = 0.xy; final datasheet = 1.xy
1.10	2021-11-05	Final datasheet

Trademarks

All referenced product or service names and trademarks are the property of their respective owners.

Edition 2021-11-05

Published by

Infineon Technologies AG

81726 Munich, Germany

© 2021 Infineon Technologies AG

All Rights Reserved.

Do you have a question about any aspect of this document?

Email: erratum@infineon.com

Document reference

IFX-AAX132-008

IMPORTANT NOTICE

The information given in this document shall in no event be regarded as a guarantee of conditions or characteristics ("Beschaffheitsgarantie").

With respect to any examples, hints or any typical values stated herein and/or any information regarding the application of the product, Infineon Technologies hereby disclaims any and all warranties and liabilities of any kind, including without limitation warranties of non-infringement of intellectual property rights of any third party.

In addition, any information given in this document is subject to customer's compliance with its obligations stated in this document and any applicable legal requirements, norms and standards concerning customer's products and any use of the product of Infineon Technologies in customer's applications.

The data contained in this document is exclusively intended for technically trained staff. It is the responsibility of customer's technical departments to evaluate the suitability of the product for the intended application and the completeness of the product information given in this document with respect to such application.

WARNINGS

Due to technical requirements products may contain dangerous substances. For information on the types in question please contact your nearest Infineon Technologies office.

Except as otherwise explicitly approved by Infineon Technologies in a written document signed by authorized representatives of Infineon Technologies, Infineon Technologies' products may not be used in any applications where a failure of the product or any consequences of the use thereof can reasonably be expected to result in personal injury.