



ORCA™ OR3TP12 FPSC Device Datasheet

June 2010

All Devices Discontinued!

Product Change Notification (PCN) #09-10 has been issued to discontinue all devices in this data sheet.

The original datasheet pages have not been modified and do not reflect those changes. Please refer to the table below for reference PCN and current product status.

Product Line	Ordering Part Number	Product Status	Reference PCN
OR3TP12	OR3TP127BA256-DB	Discontinued	PCN#09-10
	OR3TP126BA256-DB		
	OR3TP126BA256I-DB		
	OR3TP127BA352-DB		
	OR3TP126BA352-DB		



ORCA[®] OR3TP12 Field-Programmable System Chip (FPSC) Embedded Master/Target PCI Interface

Introduction

Lattice has developed a solution for designers who need the many advantages of an FPGA-based design implementation coupled with the high bandwidth of the industry-standard PCI interface. The ORCA OR3TP12 FPSC provides a full-featured 33/50/66 MHz, 32-/64-bit PCI interface, fully designed and tested, in hardware, plus FPGA logic for user-programmable functions.

PCI Local Bus

PCI local bus, or simply, PCI bus, has become an industry-standard interface protocol for use in applications ranging from desktop PC busing to high-bandwidth backplanes in networking and communications equipment. The PCI bus specification* provides for both 5 V and 3.3 V signaling environments. The PCI interface clock speed is specified in the range from dc to 66 MHz with detailed specifications at 33 MHz and 66 MHz as well as recommendations for 50 MHz operation. Data paths are defined as either 32-bit or 64-bit. These data path and frequency combinations allow for the peak data transfer rates described in Table 1.

Table 1. PCI Local Bus Data Rates

Clock Frequency (MHz)	Data Path Width (bits)	Peak Data Rate (Mbytes)
33	32	132
33	64	264
66	32	264
66	64	528

The PCI bus is electrically specified so that no glue logic is required to interface to the bus—PCI devices interface directly to the PCI bus. Other features include registers for device and subsystem identification and autoconfiguration, support for 64-bit addressing, and multimaster capability that allows any PCI bus Master access to any PCI bus Target.

PCI Bus Core Highlights

- Implemented in an ORCA Series 3 base array, displacing the bottom four rows of 18 columns.
- Core is a well-tested ASIC model.
- Fully compliant to Revision 2.1 of PCI Local Bus Specification (and designed for Revision 2.2).

* PCI Local Bus Specification Rev. 2.1, PCI SIG, June 1, 1995.

Table 2. ORCA PCI FPSC Solutions—Available FPGA Resources

Device	Usable Gates*	Number of LUTs	Number of Registers	Max User RAM	Max User I/Os	Array Size	Number of PFUs
OR3TP12	30K—60K	2016	2636	32K	187	14 × 18	252

* The embedded core and interface comprise approximately 85K standard-cell ASIC gates in addition to these usable gates. The usable gate counts range from a logic-only gate count to a gate count assuming 30% of the PFUs/SLICs being used as RAMs. The logic-only gate count includes each PFU/SLIC (counted as 108 gates per PFU/SLIC), including 12 gates per LUT/FF pair (eight per PFU), and 12 gates per SLIC/FF pair (one per PFU). Each of the four PIOs per PIC is counted as 16 gates (two FFs, fast-capture latch, output logic, clk drivers, and I/O buffers). PFUs used as RAM are counted at four gates per bit, with each PFU capable of implementing a 32 × 4 RAM (or 512 gates) per PFU.

Table of Contents

Contents	Page	Contents	Page
Introduction	1	Target Read Operation	63
PCI Local Bus	1	Clocking Options at FPGA/Embedded Core Boundary	78
PCI Bus Core Highlights	1	Configuration Space of the PCI Bus Core	80
FPSC Highlights	4	FPSC Configuration	84
Software Support	4	FPGA Configuration Target Controller Data Format	86
Description	5	Using ispLEVER to Generate Configuration RAM Data	86
What Is an FPSC?	5	FPGA Configuration Data Frame	86
FPSC Overview	5	Bit Stream Error Checking	88
TFPSC Gate Counting	5	FPGA Configuration Modes	88
FPGA/Embedded Core Interface	5	Absolute Maximum Ratings	89
FPSC Design Kit	6	Recommended Operating Conditions	89
ispLEVER Development System	6	Electrical Characteristics	90
FPGA Logic Overview	6	Timing Characteristics	91
PLC Logic	7	Description	91
PIC Logic	7	PFU Timing	92
System Features	7	PLC Timing	92
Routing	8	SLIC Timing	92
Configuration	8	PIO Timing	92
More Series 3 Information	8	Special Function Timing	92
OR3TP12 Overview	8	Clock Timing	92
Device Layout	8	Configuration Timing	92
OR3TP12 PCI Bus Core Overview	8	Readback Timing	92
PCI Bus Interface	8	Input/Output Buffer Measurement Conditions	97
Embedded Core Options/FPGA Configuration	10	Output Buffer Characteristics	98
PCI Bus Core Detailed Description	11	Estimating Power Dissipation	99
PCI Bus Commands	11	Pin Information	100
PCI Protocol Fundamentals	14	Package Thermal Characteristics Summary	113
PCI Bus Pin Information	16	Θ JA	113
Embedded Core/FPGA Interface Signal Descriptions	19	ψ JC	113
Embedded Core/FPGA Interface Signal Locations	27	Θ JC	113
Embedded Core Configuration Options	29	Θ JB	113
Embedded Core/FPGA FIFO Interface Operation Summary	31	FPGA Maximum Junction Temperature	113
PCI Bus Core Master Controller Detailed Description	32	Package Thermal Characteristics	114
FIFO Interface Overview	32	Package Coplanarity	114
Master Write Operation	33	Package Parasitics	114
Master Read Operation	41	Package Outline Diagrams	116
PCI Bus Core Target Controller Detailed Description	51	Terms and Definitions	116
Target FIFO Interface	51	256-Pin PBGA	117
Target Write Operation	51	352-Pin PBGA	118
		Ordering Information	119

PCI Bus Core Highlights (continued)

- Operates at PCI bus speeds up to 66 MHz.
- Comprises two independent controllers for Master and Target.
- Meets/exceeds all requirements for *PICMG** Hot Swap Friendly silicon, Full Hot Swap model, per the *CompactPCI** Hot Swap Specification, *PICMG* 2.1 R1.0.
- PCI SIG Hot-Plug (R1.0) compliant.
- Four internal FIFOs individually buffer both directions of both the Master and Target interfaces:
 - Both Master FIFOs are 64 bits wide by 32 bits deep.
 - Both Target FIFOs are 64 bits wide by 16 bits deep.
- Capable of no-wait-state, full-burst PCI transfers in either direction, on either the Master or Target interface. Dual 32-bit data paths extend into the FPGA logic, permitting full-bandwidth, simultaneous bidirectional data transfers of up to 264 Mbytes/s to be sustained indefinitely.
- Can be configured to provide either two 32-bit buses (one in each direction) to be multiplexed between Master and Target, or four independent 16-bit buses.
- Provides many hardware options in the PCI bus core that are set during FPGA logic configuration.
- Operates within the requirements of the PCI 5 V and 3.3 V signaling environments, allowing the same device to be used in 5 V or 3.3 V PCI systems.
- FPGA is reconfigurable via the PCI interface configuration space (as well as conventionally), allowing the FPGA to be field-updated to meet late-breaking requirements of emerging protocols.
- Master:
 - Generates all defined command codes except interrupt acknowledge and special cycle.
 - Capable of acting as the system's configuration agent by booting up with the Master logic enabled.
 - Provides multiple options to increase PCI bus bandwidth.
- Target:
 - Responds legally to most command codes: interrupt acknowledge, special cycle, and reserved commands ignored; memory read multiple and line handled as memory read; memory write and invalidate handled as memory write.
 - Implements Target abort, disconnect, retry, and wait cycles.

- Handles delayed transactions.
- Handles fast back-to-back transactions.
- Supports programmable latency timer control.
- Method of handling wait-states is programmable to allow tailoring to different Target data access latencies.
- Decodes at medium speed.
- Supports dual-address cycles (both as Master and Target).
- Supports all six base address registers (BARs), as either memory (32-bit or 64-bit) or I/O. Any legal page size can be independently specified for each BAR during FPGA configuration.
- Provides versatile clocking capabilities with FPGA clocks sourced from PCI bus clock or elsewhere. FIFO interface buffers asynchronous clock domains between the PCI interface and FPGA-based logic.
- PCI interface timing: meets or exceeds 33 MHz, 50 MHz, and 66 MHz PCI requirements.

Parameter	33 MHz	50 MHz	66 MHz
Device clock => out	11.0 ns	7.5 ns	6.0 ns
Device setup time	7.0 ns	4.5 ns	3.0 ns
Board prop. delay	10.0 ns	6.5 ns	5.0 ns
Board clock skew	2.0 ns	1.5 ns	1.0 ns
Total budget	30.0 ns	20.0 ns	15.0 ns

- Standard 256-byte PCI configuration space:
 - Class code, revision ID.
 - Latency timer.
 - Cache line size.
 - Subsystem ID.
 - Subsystem vendor ID.
 - Maximum latency, minimum grant.
 - Interrupt line.
 - Hot plug/hot swap capability.

* *CompactPCI* and *PICMG* are registered trademarks of the PCI Industrial Computer Manufacturers Group.

PCI Bus Core Highlights (continued)

- Generates interrupts on **intan** as directed by the FPGA.
- Provisions for 64-bit PCI bus capability in 352-pin PBGA package.
- Automatically detects 5 V or 3.3 V PCI bus signaling environment and provides appropriate I/O signal clamping.
- Pinout compatible with the ORCA PCI Master/Target Customer Solution Core V2.0 for OR2C/TxxA or ORCA Series 3 FPGAs.
- Ideally suited for such applications as:
 - PCI-based graphics/video/multimedia.
 - Bridges to ISA/EISA/MCA, LAN, SCSI, Ethernet, ATM, or other bus architectures.
 - High-bandwidth data transfer in proprietary systems.

FPSC Highlights

- Implemented as an embedded core into the advanced Series 3+ ORCA FPSC architecture.
- Allows the user to integrate the core with up to 60K gates of programmable logic, all in one device, and provides up to 187 user I/O pins in addition to the PCI interface pins.
- FPGA portion retains all of the features of the ORCA Series 3 FPGA architecture:
 - High-performance, cost-effective, 0.3 μm 4-level metal technology, with a migration plan to 0.25 μm technology.
 - Twin-quad programmable function unit (PFU) architecture with eight 16-bit look-up tables (LUTs) per PFU, organized in two nibbles for use in nibble- or byte-wide functions. Allows for mixed arithmetic and logic functions in a single PFU.
 - Softwired LUTs (SWL) allow fast cascading of up to three levels of LUT logic in a single PFU for up to 40% speed improvement (-5 speed grade).
 - Supplemental logic and interconnect cell (SLIC) provides 3-statable buffers, up to 10-bit decoder, and PAL*-like AND-OR-INVERT (AOI) in each programmable logic cell (PLC).
 - Up to three ExpressCLK inputs allow extremely fast clocking of signals on- and off-chip plus access to internal general clock routing.

- Dual-use microprocessor interface (MPI) can be used for configuration, readback, device control, and device status, as well as for a general-purpose interface to the FPGA. Glueless interface to *i960*[†] and *PowerPC*[‡] processors with user-configurable address space provided.
- Programmable clock manager (PCM) adjusts clock phase and duty cycle for input clock rates from 5 MHz to 120 MHz. The PCM may be combined with FPGA logic to create complex functions, such as digital phase-locked loops (DPLL), frequency counters, and frequency synthesizers or clock doublers. Two PCMs are provided per device.
- True internal 3-state, bidirectional buses with simple control provided by the SLIC.
- 32 \times 4 RAM per PFU, configurable as single or dual-port at >170 MHz (-5 speed). Create large, fast RAM/ROM blocks (128 \times 8 in only eight PFUs) using the SLIC decoders as bank drivers.
- Built-in boundary scan (*IEEE*[§] 1149.1 JTAG) and TS_ALL testability function to 3-state all I/O pins.

- High-speed on-chip interface provided between FPGA logic and embedded core to reduce bottlenecks typically found when interfacing off-chip.
- Supported in two packages: 256-pin PBGA, and 352-pin PBGA (64-bit PCI in 352-pin PBGA only).

Software Support

- Supported by ispLEVER software and third-party CAE tools for implementing ORCA Series 3+ devices and simulation/timing analysis with embedded PCI bus core.
- PCI bus core configuration options and simulation models generated by FPSC configuration manager utility in ORCA FPSC Design Kit software.
- Timing constraints provided for interface between PCI bus core and FPGA logic.

* PAL is a trademark of Advanced Micro Devices, Inc.

† i960 is a registered trademark of Intel Corporation.

‡ PowerPC is a registered trademark of International Business Machines Corporation.

§ IEEE is a registered trademark of The Institute of Electrical and Electronics Engineers, Inc.

Description

What Is an FPSC?

FPSCs, or field-programmable system chips, are devices that combine field-programmable logic with ASIC or mask-programmed logic on a single device. FPSCs provide the time to market and flexibility of FPGAs, the design effort savings of using soft intellectual property (IP) cores, and the speed, design density, and economy of ASICs.

FPSC Overview

Lattice's Series 3+ FPSCs are created from Series 3 ORCA FPGAs. To create a Series 3+ FPSC, several rows of programmable logic cells (see FPGA Logic Overview section for FPGA logic details) are removed from a Series 3 ORCA FPGA, and the area is replaced with an embedded logic core. Other than replacing some FPGA gates with ASIC gates, at greater than 10:1 efficiency, none of the FPGA functionality is changed—all of the Series 3 FPGA capability is retained: MPI, PCMs, boundary scan, etc. The rows of programmable logic are replaced at the bottom of the device, allowing pins on the bottom and sides of the replaced rows to be used as I/O pins for the embedded core. The remainder of the device pins retain their FPGA functionality as do special function FPGA pins within the embedded core area.

TFPSC Gate Counting

The total gate count for an FPSC is the sum of its embedded core (standard-cell/ASIC gates) and its FPGA gates. Because FPGA gates are generally expressed as a usable range with a nominal value, the total FPSC gate count is sometimes expressed in the same manner. Standard cell/ASIC gates are, however, 10 to 25 times more silicon area efficient than FPGA gates. Therefore, an FPSC with an embedded function is gate equivalent to an FPGA with a much larger gate count.

FPGA/Embedded Core Interface

The interface between the FPGA logic and the embedded core is designed to look like FPGA I/Os from the FPGA side, simplifying interface signal routing and providing a unified approach with general FPGA design. Effectively, the FPGA is designed as if signals were going off of the device to the embedded core, but the on-chip interface is much faster than going off-chip and requires less power. All of the delays for the interface are precharacterized and accounted for in the ispLEVER software.

Clock spines also can pass across the FPGA/embedded core boundary. This allows for fast, low-skew clocking between the FPGA and the embedded core. Many of the special signals from the FPGA, such as DONE and global set/reset, are also available to the embedded core, making it possible to fully integrate the embedded core with the FPGA as a system.

For even greater system flexibility, FPGA configuration RAMs are available for use by the embedded core. This allows for user-programmable options in the embedded core, in turn allowing for greater flexibility. Multiple embedded core configurations may be designed into a single device with user-programmable control over which configurations are implemented, as well as the capability to change core functionality simply by reconfiguring the device.

Description (continued)

FPSC Design Kit

Development is facilitated by an FPSC Design Kit which, together with ispLEVER and third-party synthesis and simulation engines, provides all software and documentation required to design and verify an FPSC implementation. Included in the kit are the FPSC configuration manager, Verilog* and VHDL* simulation models, all necessary synthesis libraries, and complete online documentation. The kit's software couples with ispLEVER software under the control of the ispLEVER Control Center (OFCC), providing a seamless FPSC design environment. More information can be obtained by visiting the ORCA website or contacting a local sales office, both listed on the last page of this document.

ispLEVER Development System

The ispLEVER development system is used to process a design from a netlist to a configured FPSC. This system is used to map a design onto the ORCA architecture and then place and route it using ispLEVER software's timing-driven tools. The development system also includes interfaces to, and libraries for, other popular CAE tools for design entry, synthesis, simulation, and timing analysis.

The ispLEVER development system interfaces to front-end design entry tools and provides the tools to produce a configured FPSC. In the design flow, the user defines the functionality of the FPGA portion of the FPSC and embedded core settings at design entry stage. The embedded core options determine the FPSC functionality.

Following design entry, the development system's map, place, and route tools translate the netlist into a routed FPSC. A static timing analysis tool is provided to determine design speed, and a back-annotated netlist can be created to allow simulation. Simulation output files from ispLEVER are also compatible with many third-party analysis tools. Its bit stream generator is then used to generate the configuration data which is loaded into the FPSC's internal configuration RAM. When using the FPSC configuration manager, the user selects options that affect the functionality of the FPSC. Combined with the front-end tools, ispLEVER produces configuration data that implements the various logic and routing options discussed in this data sheet.

FPGA Logic Overview

ORCA Series 3 FPGA logic is a new generation of SRAM-based FPGA logic built on the successful Series 2 FPGA line, with enhancements and innovations geared toward today's high-speed designs and tomorrow's systems on a single chip. Designed from the start to be synthesis friendly and to reduce place and route times while maintaining the complete routability of the ORCA Series 2 devices, the Series 3 more than doubles the logic available in each logic block and incorporates system-level features that can further reduce logic requirements and increase system speed. ORCA Series 3 devices contain many new patented enhancements and are offered in a variety of packages, speed grades, and temperature ranges.

ORCA Series 3 FPGA logic consists of three basic elements: PLCs, programmable input/output cells (PICs), and system-level features. An array of PLCs is surrounded by PICs. Each PLC contains a PFU, a SLIC, local routing resources, and configuration RAM. Most of the FPGA logic is performed in the PFU, but decoders, PAL-like functions, and 3-state buffering can be performed in the SLIC. The PICs provide device inputs and outputs and can be used to register signals and to perform input demultiplexing, output multiplexing, and other functions on two output signals. Some of the system-level functions include the new microprocessor interface (MPI) and the PCM.

* Verilog and VHDL are registered trademarks of Cadance Design Systems, Inc.

Description (continued)

PLC Logic

Each PFU within a PLC contains eight 4-input (16-bit) LUTs, eight latches/flip-flops (FFs), and one additional flip-flop that may be used independently or with arithmetic functions.

The PFU is organized in a twin-quad fashion: two sets of four LUTs and FFs that can be controlled independently. LUTs may also be combined for use in arithmetic functions using fast-carry chain logic in either 4-bit or 8-bit modes. The carry-out of either mode may be registered in the ninth FF for pipelining. Each PFU may also be configured as a synchronous 32×4 single- or dual-port RAM or ROM. The FFs (or latches) may obtain input from LUT outputs or directly from invertible PFU inputs, or they can be tied high or tied low. The FFs also have programmable clock polarity, clock enables, and local set/reset.

The SLIC is connected to PLC routing resources and to the outputs of the PFU. It contains 3-state, bidirectional buffers and logic to perform up to a 10-bit AND function for decoding, or an AND-OR with optional INVERT AOI to perform PAL-like functions. The 3-state drivers in the SLIC and their direct connections to the PFU outputs make fast, true 3-state buses possible within the FPGA logic, reducing required routing and allowing for real-world system performance.

PIC Logic

The Series 3T PIC addresses the demand for ever-increasing system clock speeds. Each PIC contains four programmable inputs/outputs (PIOs) and routing resources. On the input side, each PIO contains a fast-capture latch that is clocked by an ExpressCLK. This latch is followed by a latch/FF that is clocked by a system clock from the internal general clock routing. The combination provides for very low setup requirements and zero-hold times for signals coming on-chip. It may also be used to demultiplex an input signal, such as a multiplexed address/data signal, and register the signals without explicitly building a demultiplexer. Two input signals are available to the PLC array from each PIO, and the ORCA Series 2 capability to use any input pin as a clock or other global input is maintained.

On the output side of each PIO, two outputs from the PLC array can be routed to each output flip-flop, and logic can be associated with each I/O pad. The output logic associated with each pad allows for multiplexing of output signals and other functions of two output signals.

The output FF, in combination with output signal multiplexing, is particularly useful for registering address signals to be multiplexed with data, allowing a full clock cycle for the data to propagate to the output. The I/O buffer associated with each pad is the same as the ORCA Series 3T buffer.

System Features

The Series 3 also provides system-level functionality by means of its dual-use microprocessor interface (MPI) and its innovative PCM. These functional blocks allow for easy glueless system interfacing and the capability to adjust to varying conditions in today's high-speed systems. Since these and all other Series 3T features are available in every Series 3+ FPSC, they can also interface to the embedded core providing for easier system integration.

Description (continued)

Routing

The abundant routing resources of ORCA Series 3 FPGA logic are organized to route signals individually or as buses with related control signals. Clocks are routed on a low-skew, high-speed distribution network and may be sourced from PLC logic, externally from any I/O pad, or from the very fast ExpressCLK pins. ExpressCLKs may be glitchlessly and independently enabled and disabled with a programmable control signal using the new StopCLK feature. The improved PIC routing resources are now similar to the patented intra-PLC routing resources and provide great flexibility in moving signals to and from the PIOs. This flexibility translates into an improved capability to route designs at the required speeds when the I/O signals have been locked to specific pins.

Configuration

The FPGA logic's functionality is determined by internal configuration RAM. The FPGA logic's internal initialization/configuration circuitry loads the configuration data at powerup or under system control. The RAM is loaded by using one of several configuration sources, including serial EEPROM, the microprocessor interface, or the embedded function core.

More Series 3 Information

For more information on Series 3 FPGAs, please refer to the Series 3 FPGA data sheet, available on the Lattice website.

OR3TP12 Overview

Device Layout

The OR3TP12 FPSC provides a PCI local bus core (with FIFOs) combined with FPGA logic. The device is based on a 3.3 V OR3T55 FPGA. The OR3T55 has an 18 × 18 array of PLCs. For the OR3TP12, the bottom four rows of PLCs in the array were replaced with the embedded PCI bus core. Figure 1 shows a schematic view of the OR3TP12. The upper portion of the device is a 14 × 18 array of PLCs surrounded on the left, top, and right by programmable input/output cells (PICs). At the bottom of the PLC array are interface cells connecting to the embedded core region. The embedded core

region contains the PCI bus functionality of the device. It is surrounded on the left, bottom, and right by PCI bus dedicated I/Os as well as power and special function FPGA pins. Also shown are the interquad routing blocks (hIQ, vIQ) present in the Series 3T FPGA devices. System-level functions (located in the corners of the PLC array), routing resources, and configuration RAM are not shown in Figure 1.

OR3TP12 PCI Bus Core Overview

The OR3TP12 embedded core comprises a PCI bus interface with independent Master and Target controllers, FIFO memories, control logic for data buffering, a dual-/quad-port interface to the FPGA logic which performs data packing and multiplexing, and logic to support the embedded core and FPGA configuration. A detailed description of all of the features and functionality of the OR3TP12 embedded core is provided in the following sections.

PCI Bus Interface

The OR3TP12 PCI bus core is compliant to Revision 2.1 of the PCI Local Bus specification. It is capable of no-wait-state, full-burst operation at all of the rate/data width combinations described in Table 1 as well as at a 50 MHz specification that provides a speed increase over the 33 MHz specification and a larger bus loading capability than the 66 MHz specification. The OR3TP12 operates in either the 3.3 V or 5 V PCI signaling environment and is automatically configured for the appropriate environment by a PCI bus **vio** pin.

Independent Master and Target controllers are provided for use in systems requiring Master/Target or Target only operation. Six 32-bit base address registers (BARs) are provided for decoding the address space of the PCI device, and these six 32-bit registers can be combined in pairs to produce 64-bit BARs. Dual-address cycles are supported when the PCI bus is either 32 or 64 bits wide. The BARs work in either the I/O or the memory space of the device and can be configured as prefetchable or nonprefetchable.

OR3TP12 Overview (continued)



5-4489(F).b

Figure 1. OR3TP12 Array

OR3TP12 Overview (continued)

Independent data paths exist for the Master and Target FIFO interface. This allows for separate operation of Master and Target functions, and the capability for a Master to transfer data to a Target on the same device.

In dual-port mode, the Master and Target FIFO interfaces share two unidirectional 32-bit data paths between the FIFOs and the FPGA logic. This provides for full-rate transfers in 32-bit PCI bus operation, when operating the FPGA application and PCI bus at the same frequency.

Quad-port mode provides two independent 16-bit data paths for each FIFO interface: one for read data and the other for write data. This mode allows for simultaneous operations on either the Master or Target controller.

Diagrams for dual-port and quad-port operation are shown in Figure 2.

Embedded Core Options/FPGA Configuration

In addition to the Series 3 FPGA configuration modes, the OR3TP12 can also be configured via the PCI bus. Configuration as discussed here covers two operations. There is configuration of the FPGA logic, and there is configuration of the options available in the embedded core. Both are accomplished through the FPGA configuration process. Readback of FPGA and PCI bus core options is also possible using the PCI bus or Series 3T FPGA readback modes. At powerup, the PCI bus core will be functional with a default PCI bus configuration space, as defined in the PCI bus 2.1 specification, even prior to an initial configuration of the FPGA logic.

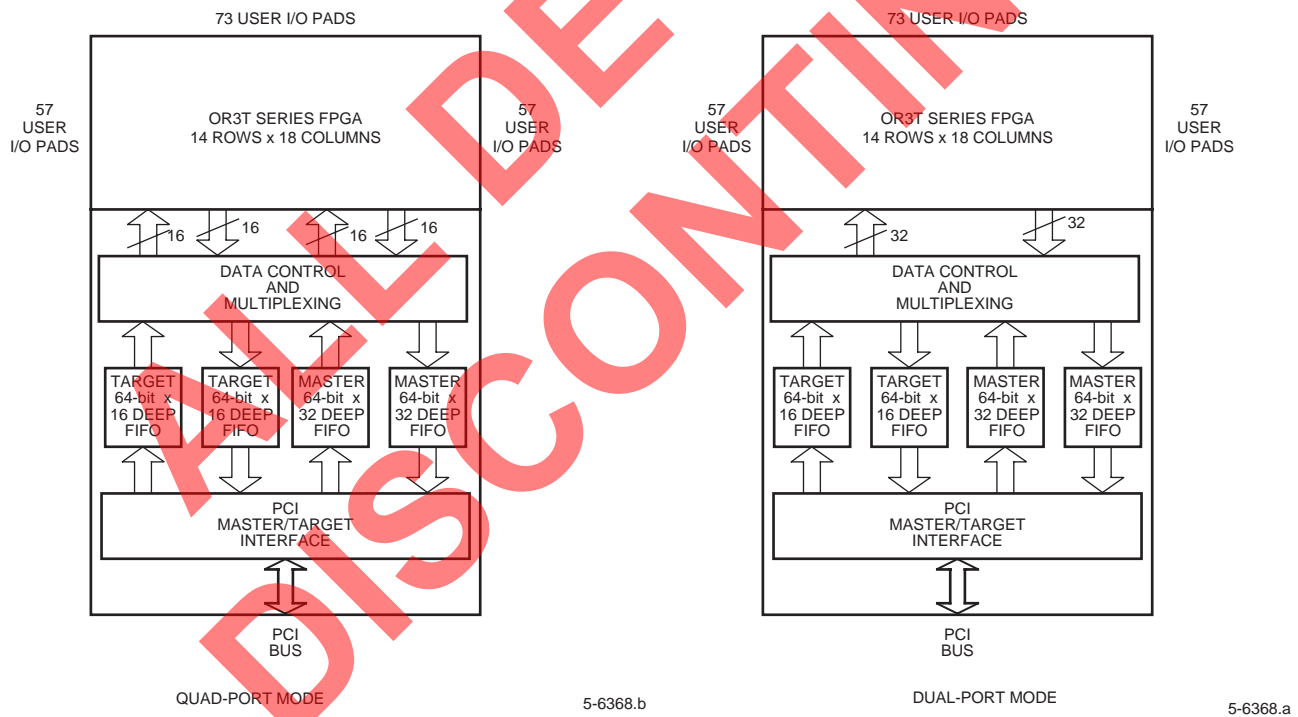

Figure 2. ORCA OR3TP12 PCI FPSC Block Diagram

PCI Bus Core Detailed Description

The following sections describe the operation of the embedded PCI bus core interface.

PCI Bus Commands

The PCI bus core supports all commands required by the PCI Specification. The following table describes each command. Subsequent sections will describe the protocols in which the commands are used.

Table 3. PCI Bus Command Descriptions

Command Code (Binary)	Command	OR3TP12 Master Generates	OR3TP12 Target Accepts	Description
0000	Interrupt Acknowledge	—	—	Only implemented by Master agents that interface to the system CPU and as Target by agents that incorporate the system interrupt controller.
0001	Special Cycle	—	—	Target ignores, per PCI Specification Section 3.7.2.
0010	I/O Read	√	√	<p>Target: Single accesses only, with bursts disconnected after first data phase.</p> <p>Delayed Mode ($deltrn = 0$): Terminates the initial access with a retry, recording internally the PCI address and byte enables for processing by the FPGA application. Subsequent PCI accesses occurring before the FPGA application loads the Target read FIFO continues to result in retries. After the Target read FIFO is loaded by the FPGA application, the next read access that matches the stored parameters disconnects with the FPGA supplied data and the Target read logic is cleared.</p> <p>Nondelayed Mode ($deltrn = 1$, $trburstpendn = 0$): Accepted access inserts wait-states up to the initial latency count (16 or 32 clocks depending on the option selected in the FPSC configuration manager). During the wait-states, the FPGA application processes the read request and transfers data into the Target read FIFOs. If read data is transferred into the Target read FIFOs before the latency count expires, this read data is transferred to the PCI bus during initial request. If not, the PCI address, byte enables, and Target read data remain stored in the Target controller. The next access that matches the stored address and byte enables disconnects with the FPGA supplied data, and the Target read logic is cleared.</p> <p>Master: Single and burst operations are allowed.</p>

PCI Bus Core Detailed Description (continued)

Table 3. PCI Bus Command Descriptions (continued)

Command Code (Binary)	Command	OR3TP12 Master Generates	OR3TP12 Target Accepts	Description
0011	I/O Write	√	√	<p>Target: Single accesses only, with bursts disconnected after first data phase.</p> <p><u>Delayed Mode (deltrn = 0):</u> Terminates the initial access with a retry, recording internally the PCI address, byte enables, and write data for processing by the FPGA application. Subsequent PCI accesses occurring before the FPGA application accepts the Target write data will result in retries. After the Target write data is received by the FPGA application, the next I/O write access that matches the stored parameters (PCI address, byte enables, and write data) disconnects with data, and the Target write logic is cleared.</p> <p><u>Nondelayed Mode (deltrn = 1, trburstpendn = 0):</u> Access posts write data into the Target write FIFOs and disconnects with data. The FPGA application then processes the I/O write request and transfer data from Target write FIFOs.</p> <p>Master: Single and burst operations are allowed.</p>
0100	(reserved)	—	—	Target ignores, per PCI Specification Section 3.1.1.
0101	(reserved)	—	—	Target ignores, per PCI Specification Section 3.1.1.
0110	Memory Read	√	√	<p>Target: Single and burst accesses are allowed. The amount of data transferred will depend on either the external PCI Master terminating the read transaction, or the Target read FIFOs becoming empty.</p> <p><u>Delayed Mode (deltrn = 0):</u> Terminates the initial access with a retry, recording internally the PCI address and byte enables for processing by the FPGA application. Subsequent PCI accesses occurring before the FPGA application loads the Target read FIFO continues to result in retries. After the Target read FIFO is loaded by the FPGA application, the next read access that matches the stored parameters begins transfer of the FPGA supplied data.</p> <p><u>Nondelayed Mode (deltrn = 1, trburstpendn = 0):</u> Accepted access inserts wait-states up to the initial latency count (16 or 32 clocks depending on the option selected in the FPSC configuration manager). During the wait-states, the FPGA application processes the read request and transfer data into the Target read FIFOs. If read data is transferred into the Target read FIFOs before the latency count expires, this read data is transferred to the PCI bus during initial request. If not, the PCI address, byte enables, and Target read data are stored in the Target controller. The next access that matches the stored address and byte enables begins transfer of the FPGA supplied data.</p> <p>Master: Single and burst operations are allowed.</p>

PCI Bus Core Detailed Description (continued)

Table 3. PCI Bus Command Descriptions (continued)

Command Code (Binary)	Command	OR3TP12 Master Generates	OR3TP12 Target Accepts	Description
0111	Memory Write	√	√	Fully implemented. Target: Writes are posted, bursting is allowed, and wait-states generation is controllable. When the Target write FIFO is full, the next data phase will be disconnected without data ($twburstpendn = 1$), or up to eight wait-states can be inserted ($twburstpendn = 0$). After the PCI bus transaction completes and the FPGA application empties the Target write FIFO, the Target write logic is cleared. Master: Single and burst operations are allowed.
1000	(reserved)	—	—	Target ignores, per PCI Specification Section 3.1.1.
1001	(reserved)	—	—	Target ignores, per PCI Specification Section 3.1.1.
1010	Configuration Read	√	√	Target: Bursting is disallowed, and no wait-states are generated. Target disconnects with data on first data word. The FPGA portion of the device is not involved in configuration transactions. Master: Single and burst operations are allowed.
1011	Configuration Write	√	√	Fully implemented. Target: Bursting is disallowed, and no wait-states are generated. Target disconnects with data on first data word. The FPGA portion of the device is not involved in configuration transactions. Master: Single and burst operations are allowed.
1100	Memory Read Multiple	√	√	Fully implemented. Both the Master and the Target treat this instruction the same as a memory read (4'b0110); the user's FPGA logic is responsible for ensuring that the Master operation meets the special requirement that the read request ends on a cacheline boundary.
1101	Dual-Access Cycle	√	√	Fully implemented. Per PCI Specification 2.1, Section 3.10.1, the PCI bus core (as a Master) automatically converts a 64-bit address to a 32-bit address if the upper 32 bits are all zeros.
1110	Memory Read Line	√	√	Fully implemented. Both the Master and the Target treat this instruction the same as a memory read (0110). The user's FPGA logic is responsible for ensuring that the Master operation meets the special requirement that the read request continues to the next cacheline boundary.
1111	Memory Write and Invalidate	√	√	Fully implemented. Both the Master and the Target treat this instruction the same as a memory write (0111); the user's FPGA logic is responsible for ensuring that the Master operation meets the special requirement that writes of complete cachelines, with all byte enables, are performed.

PCI Bus Core Detailed Description

(continued)

PCI Protocol Fundamentals

Basic Transfer Control

The following paragraphs describe various aspects of the PCI protocol and the way they are handled by the PCI bus core.

Addressing. The PCI Specification defines three types of address spaces. The first, configuration address space, is a physical address space that is intended as a means for powerup software to identify agents and allocate them address space. The second, I/O address space, is intended for mapping I/O control functions. The third, memory address spaces, is intended for bulk data transfer. It has features to facilitate this, such as special commands for cache implementation, large page sizes, and mechanisms for prefetching. The PCI bus core handles all three address space types as both a Master and a Target.

Byte Alignment. On all write operations (configuration, I/O, and memory) for both the PCI bus core's Master and Target functions, byte enables are fully implemented from/to the FPGA interface. Note, however, that even though the PCI bus core implements the ability to control byte enables for the memory write and invalidate instruction, the PCI Specification requires that this instruction assert all byte enables, and this is the FPGA application's responsibility. On read operations, the utility of byte enables is more dubious since the data must be enroute from the PCI bus Target to Master, at the time that the corresponding byte enables are enroute from the PCI bus Master to Target (unless wait-states are inserted). The PCI bus core, therefore, does not implement full-byte enable control for Target reads, and limited for Master reads.

For the OR3TP12, byte enables on Master read burst operations must always be asserted; nonburst Master reads may manipulate the byte enables. Byte enables on Target read operations are ignored, in accordance with PCI Specification 2.1, Section 3.2.3. All Master burst read and write addresses must be aligned on 64-bit boundaries. Single read and write addresses can be aligned on 32-bit boundaries.

Device Selection (*devseln*)

The Target is responsible for decoding the address of a Master's request by asserting the PCI bus signal **devseln**. **devseln** may be asserted one, two, or three clocks after the address phrase of a transaction, corresponding to fast, medium, or slow decode, respectively. The PCI bus core's Target is capable of performing a medium-speed decode response. The decode response speed has a significant impact on the overall latency and bandwidth of nonburst PCI transactions. Its impact decreases greatly for burst transactions, particularly for burst lengths of the size of the PCI bus core's FIFOs.

Address/Data Stepping

Stepping is an optional feature added to the PCI Specification to accommodate agents whose bus drive capability is insufficient to handle large groups of signals changing state in one clock cycle. Continuous stepping allows weak drivers multiple cycles for signal transition. Discrete stepping partitions the bus into two or more groups of bits that transition on successive clock cycles. However, stepping exacts a heavy toll on performance, cutting maximum bandwidth by at least 50% and increasing latency. The PCI core is designed for maximum throughput with high-performance buffers, so stepping is unnecessary and not implemented. The wait cycle control, bit seven of the command register, is therefore hardwired to a 0.

Interrupt Acknowledge

The interrupt acknowledge command is a read by the system CPU implicitly addressed to the system interrupt controller. Other agents, including the PCI bus core, are not required to implement this instruction; the PCI bus core's Master does not generate it, and its Target ignores it.

Arbitration Parking

The PCI Specification requires that all Master agents properly handle bus parking, which means that when that agent receives an asserted **gntn** without the agent having asserted its **reqn**, the agent still must drive signal **par** and buses **ad** and **c_ben** to a stable value. The PCI bus core meets this requirement.

PCI Bus Core Detailed Description

(continued)

Parity

The PCI bus core implements all required and optional features, including the following:

- Master generates parity on all addresses placed on the bus.
- Sending agent generates parity on all data placed on the bus.
- Target calculates parity on all addresses received from the bus.
- Receiving agent calculates parity on all data received from the bus.
- The detected parity error bit in the status register is set whenever an agent calculates corrupted parity.
- The signal **perrrn** is generated whenever an agent calculates corrupted data parity and the parity error response bit is set in the PCI command register.
- The signal **serrrn** is generated whenever an agent calculates a corrupt address parity.

66 MHz Operation

The PCI bus core is fully compliant to PCI Specification requirements at all clock rates up to 66 MHz. All 33 MHz requirements are also met.

Timing Budget

The PCI bus core's timing budget is summarized in Table 4. Note that the 66 MHz timing requirements only allow 5 ns for signal propagation (TPROP), as compared to 10 ns at 33 MHz. The effect of the reduction is to reduce also the number of agents that the bus can support, although the actual number is not specified in the PCI Specification and is dependent on the design of the hardware components. The four components of the timing budget are TVAL (valid output delay), TPROP (propagation time), TSU (input setup time), and TSKEW (clock skew); of these, only TVAL and TSU are controlled by the PCI component, and TPROP and TSKEW are system parameters. Table 4 includes a third column (also shown in the PCI Specification); this column indicates the performance attainable if all 66 MHz requirements are met except TPROP = 10 ns, which is the 33 MHz value. In this case, the total budget increases from 15 ns (66 MHz) to 20 ns (50 MHz).

Table 4. Timing Budgets

Timing Element	33 MHz	50 MHz	66 MHz	Unit
Cycle Time	30.0	20.0	15.0	ns
Valid Output Delay	11.0	7.5	6.0	ns
Propagation Time	10.0	6.5	5.0	ns
Input Setup Time	7.0	4.5	3.0	ns
Clock Skew	2.0	1.5	1.0	ns

64-Bit Addressing

The PCI bus core fully supports 64-bit addressing, whether or not the PCI bus core is configured to utilize the 64-bit data extension. When the PCI bus core is a 64-bit Target being addressed by 64-bit Master, the PCI bus core will decode the address one cycle faster so that dual-address operation will have no performance impact; see PCI Specification 2.1, Section 3.10.1 for details.

Section 3.10.1 of the PCI Specification 2.1 also states that a Master that supports 64-bit addressing must nevertheless generate requests utilizing a single address instead of a dual-address when the upper 32 bits are all zeros. This shortens the request time by one cycle when communicating with 32-bit Targets.

FIFO Memories and Control

The OR3TP12 embedded core contains four FIFO memories and supporting control logic. Two FIFOs are for the Master FIFO interface data and two for the Target FIFO interface data. These FIFOs are configured to operate in 64-bit mode and can also carry byte enable bits on a per-byte basis (e.g., a 64-bit FIFO actually carries 64 bits of data and eight byte enable bits for a total of 72 bits). All FIFOs have two relevant flags which extend into the FPGA logic for user application (e.g., a Target read FIFO on the FPGA side has Full and Full-4 flags extending into the FPGA logic). Clocking for the FPGA port of all FIFOs is flexible, with options for different clocks for the Master and Target FIFOs, all sourced by the FPGA logic.

PCI Bus Core Detailed Description (continued)

PCI Bus Pin Information

This section describes signals on the PCI bus interface and at the embedded core/FPGA interface. Some signal definitions change name and location based on the mode of operation. Modes of operation are described following the signal descriptions. PCI bus signal package pin locations can be found in Table 42 through .

Table 5. PCI Bus Pin Descriptions

Symbol	I/O	Description
System Pins		
clk	I	Clock. Provides timing for all transactions on the PCI bus and is an input to the OR3TP12 device. All PCI signals, except rstn and intan , are sampled on the rising edge of clk , and all other PCI bus timing parameters are defined with respect to this edge. clk operates up to 66 MHz, and the minimum frequency is dc.
rstn	I	Reset. An active-low signal used to reset the entire PCI bus. rstn is asynchronous to clk . When asserted, all PCI output signals are 3-stated.
Address and Data Pins		
ad[31:0]	I/O	Address and Data. Multiplexed on the same PCI pins. A PCI bus transaction consists of an address phase followed by one or more data phases. During data phases, ad[7:0] contain the least significant byte and ad[31:24] contain the most significant byte. During memory commands, the ad[31:2] lines specify the address and ad[1:0] specify the type of bursting sequence to use. The table below outlines the bursting sequence based on the values of ad[1:0] for the Target. ad[1:0] Bursting sequence. 00 Linear incrementing accepted by the Target. 01 Target disconnect after first transfer. 10 Target disconnect after first transfer. 11 Target disconnect after first transfer.
c_ben[3:0]	I/O	Bus Command and Byte Enables. Active-low signals multiplexed on the same PCI pins. During the address phase of a transaction, c_ben[3:0] define the bus command. During the data phase, c_ben[3:0] are used as byte enables. The byte enables are valid for the entire data phase and determine which byte lanes carry meaningful data.
par	I/O	Parity. Specifies even parity across ad[31:0] and c_ben[3:0] . par is stable and valid one clock after the address phase. For data phases, par is stable and valid one clock after irdyn is asserted on a write transaction or trdyn is asserted on a read transaction. Once par is valid, it remains valid until one clock after the completion of the current data phase. The Master drives par for address and write data phases; the Target drives par for read data phases.
Interface Control Pins		
framen	I/O	Cycle Frame. An active-low signal driven by the current Master to indicate the beginning and duration of an access. framen is asserted to indicate a bus transaction is beginning. While framen is asserted, data transfers continue. When framen is deasserted, the transaction is in the final phase or has completed.

PCI Bus Core Detailed Description (continued)

Table 5. PCI Bus Pin Descriptions (continued)

Symbol	I/O	Description
Interface Control Pins (continued)		
irdyn	I/O	Initiator Ready. An active-low signal indicating the bus Master's ability to complete the current data phase of the transaction. irdyn is used in conjunction with trdyn . A data phase is completed on any clock cycle during which both irdyn and trdyn are asserted. During a write, irdyn indicates that valid data from the Master is present on the ad bus. During a read, it indicates that the Master is prepared to accept data. Wait cycles are inserted until both irdyn and trdyn are asserted together.
trdyn	I/O	Target Ready. An active-low signal asserted to indicate the readiness of the Target's agent to complete the current data phase of the transaction. trdyn is used in conjunction with irdyn . A data phase is completed on any clock cycle where both trdyn and irdyn are sampled active. During reads, trdyn indicates that valid data from the Target is present on the ad bus. During write cycles, trdyn indicates that the Target is prepared to accept data.
stopn	I/O	Stop. Indicates that the current Target is requesting the Master to stop the current transaction.
idsel	I	Initialization Device Select. Used as a chip select during PCI configuration read and write transactions. Generally, the user ties idsel to one of the upper 24 address lines, ad[31:8] .
devseln	I/O	Device Select. An active-low signal indicating that a Target device on the bus has been selected. As an output, it indicates that the driving device has decoded its address as the Target of the current access.
Arbitration Pins (for Bus Master Only)		
reqn	O	Request. An active-low signal that indicates to the arbiter that the asserting agent desires use of the bus. In the OR3TP12, this signal is asserted when the OR3TP12 Master controller needs access to the PCI bus.
gntn	I	Grant. An active-low signal that indicates to the OR3TP12 Master that access to the PCI bus has been granted.
Error Reporting Pins		
perrn	I/O	Parity Error. An active-low signal for the reporting of data parity errors during all PCI transactions except a special cycle. The perrn pin is a sustained 3-state signal and must be driven active by the agent receiving data two clocks following the data when a data parity error is detected. The minimum duration of perrn is one clock for each data phase that a data parity error is detected. If sequential data phases each have a data parity error, the perrn signal will be asserted for more than a single clock. perrn is driven high for one clock before being 3-stated. perrn is not asserted until it has claimed the access by asserting devseln and completed a data phase.
serrn	O	System Error. An active-low signal pulsed by agents to report errors other than data parity. serrn is sampled every clk edge, so any agent asserting serrn must ensure it is valid for at least one clock period. For example, serrn can be asserted if an abort sequence is detected by the Master, or an address parity error is detected by the Target.

PCI Bus Core Detailed Description (continued)

Table 5. PCI Bus Pin Descriptions (continued)

Symbol	I/O	Description
Interrupt Pins		
intan	O	PCI Interrupt. The OR3TP12 asserts this active-low signal when it requests an interrupt from the PCI compliant interrupt controller.
64-Bit Bus Extension Pins		
ad[63:32]	I/O	64-Bit Address and Data. These signals provide the upper 32 bits of address and data when in PCI 64-bit operation. During a 64-bit address phase (when using the dual-address command (DAC) and when req64n is asserted), the upper 32-bit address bits are transferred. During a data phase, the data is valid when req64n and ack64n are both asserted. Otherwise, these bits are 3-stated.
c_ben[7:4]	I/O	Byte Enables. These are the upper four, active-low, bus command and byte enables when in PCI 64-bit operation. During a 64-bit address phase (when using the dual-address command (DAC) and when req64n is asserted), the bus command is transferred. During a data phase, these bits are the active-low byte enables for data bits ad[63:32]. Otherwise, these bits are 3-stated.
req64n	I/O	Request 64-Bit Transfer. This active-low signal is asserted by the current bus Master to indicate that it desires to transfer data using 64 bits.
ack64n	I/O	Acknowledge 64-Bit Transfer. Within its decoded address space (DEVSELN asserted), the Target drives this signal active-low indicating that it can perform 64-bit data transfers, in response to a received active-low req64n. ack64n has the same timing as devseln in 32-bit transfers.
par64n	I/O	Upper Double-Word Parity. The even parity bit that covers ad[63:32] and c_ben[7:4]. par64n is valid one clock after the initial address phase when req64n is asserted and the dual-address command (DAC) is indicated on c_ben[3:0]. It is also valid the clock cycle after the second address phase of a DAC command when req64n is asserted. For data phases, par64n is stable and valid one clock after irdyn is asserted on a write transaction or trdyn is asserted on a read transaction. Once par64n is valid, it remains valid until one clock after the completion of the current data phase. On 64-bit PCI buses, the Master drives par64n for address and write data phases; the Target drives par64n for read data phases.
Hot Swap Function Pins		
enumn	O	Enumeration. Active-low signal that notifies the system host that the card has been freshly inserted or is about to be extracted. The system host can then either install (for insertion) or deactivate (for extraction) the card's software driver to adjust for the change in system configuration.
ledn	O	LED. Active-low open-drain signal that drives a external blue LED, indicating that removal of the card is permitted. This signal is asserted low whenever the LED ON/OFF (LOO) bit in the hot swap control and status register (HSSCR) is asserted high.
ejectsw	I	Eject Switch. Active-high signal that indicates that the card's ejector handle is unseated. This signals that the operator has freshly inserted the card, or will extract the card when the blue LED illuminates. If not used, tie high or low.
vio	I	PCI Bus Signaling Environment Voltage. This input indicates to the PCI bus core the signaling environment being employed on the PCI bus. The input is tied to the appropriate voltage supply (either 5.0 V or 3.3 V).

PCI Bus Core Detailed Description (continued)

Embedded Core/FPGA Interface Signal Descriptions

In Table 6, an input refers to a signal flowing into the FPGA logic (out of the embedded core) and an output refers to a signal flowing out of the FPGA logic (into the embedded core).

Table 6. Embedded Core/FPGA Interface Signals

Symbol	I/O	Description	Clock Domain
Master General Signals			
fpga_mbusyn	O	FPGA Master Is Busy. The FPGA application asserts this active-low signal to indicate to the Master to assert the reqn signal until fpga_mbusyn becomes inactive or the Target disconnects. This is helpful in PCI applications in which Master has multiple high-priority transactions to be performed. Once asserted, this signal needs to remain asserted for a minimum of two pciclk cycles.	pciclk
fpga_msyerror	I	FPGA Master Cycle Aborted by PCI Target. The Master controller asserts this active-high signal as an indication that the current cycle to the PCI bus has been aborted.	fclk*
mstatecntr[3:0]	I	Master State Counter. Indicates the current state of the Master FIFO interface. Details of the Master FIFO interface can be found in the PCI Bus Core Master Controller Detailed Description section of this data sheet.	fclk*
mfifoclrn	O	Master FIFO Clear. This active-low signal is asynchronously asserted by the FPGA application to clear the Master address, read, and write FIFOs, along with mstatecntr . This signal does not reset the Master Controllers PCI state machine within the embedded core, and therefore it is not recommended to be used to terminate the current PCI transaction.	—
m_ready	I	Master Logic Ready. This active-high signal indicates that the Master FIFO interface to the FPGA logic is ready. This signal will be inactive during PCI bus resets and Master FIFO clears.	fclk*
Master FIFO Address and Command Control Signals			
maenn	O	Master Command/Start Address/Read Burst Length Enable. This is an active-low signal used to register the Master command word, read burst length, and PCI start address into the Master controller registers. The type of data transferred from the FPGA application will depend on the current state of mstatecntr and the interface mode (quad-port or dual-port). Further description is provided in the Command/Address Setup section (see page 33) of the PCI Bus Core Master Controller Detailed Description section.	fclk*
ma_fulln	I	Master Address Register Full Flag. This active-low signal indicates that the Master address register is full and no new PCI Master transactions can be accepted from the FPGA application. This flag is cleared when the Master transaction is completed on the PCI bus. For Master writes, ma_fulln is cleared when all write data has been transferred to the external Target. For Master reads, ma_fulln is cleared when all read data has been received from the external Target, although all read data may not have been transferred to the FPGA application.	fclk*

* The source of the clock (**fclk1** or **fclk2**) for the FIFO interface (Master or Target) is selected in the FPSC configuration manager.

PCI Bus Core Detailed Description (continued)

Table 6. Embedded Core/FPGA Interface Signals (continued)

Symbol	I/O	Description	Clock Domain
Master Write Data FIFO Signals			
mwlastcycn	O	Master Write Last Data Cycle. This active-low signal has two functions: a. It is asserted low to indicate that the current Master start address word is the final portion being sent. It can be asserted prior to any address portion being transferred, indicating to use the previous stored address in the selected Master holding register. maenn must be asserted with mwlastcycn during the final address word. b. It is asserted low to indicate that the accompanying Master write data is the final data for this operation. mwdataenn must be asserted with mwlastcycn during the final data word.	fclk*
mwdataenn	O	Master Write FIFO Data Enable. This active-low signal enables the registering of data bus mwdata (quad-port mode) or datafmfpga (dual-port mode) during Master write operations into the Master write data FIFOs. mwdataenn should not be asserted when the Master write data FIFOs are full, or data may be lost.	fclk*
mwpcihold	O	Master Write PCI Bus Hold. For Master write transfers on the PCI bus, this signal delays the start of the transfer (i.e., reqn asserted) on the PCI bus, allowing the FPGA application to fill the Master write data FIFO. The transaction will begin when mwpcihold is deasserted or the Master write data FIFO becomes full. mwpcihold should be deasserted before mwlastcycn is asserted, and needs to remain asserted for a minimum of two pciclk cycles.	pciclk
mw_afulln	I	Master Write Data FIFO Almost Full Flag. This active-low signal indicates that only four more empty 64-bit locations remain in the Master write data FIFO.	fclk*
mw_fulln	I	Master Write Data FIFO Full Flag. This active-low signal indicates that the Master write data FIFO is full. mwdataenn should never be asserted when mw_fulln is active.	fclk*

* The source of the clock (**fclk1** or **fclk2**) for the FIFO interface (Master or Target) is selected in the FPSC configuration manager.

PCI Bus Core Detailed Description (continued)

Table 6. Embedded Core/FPGA Interface Signals (continued)

Symbol	I/O	Description	Clock Domain																																																			
Master Write Data FIFO Signals (continued)																																																						
mwwdata[17:0] (quad-port mode) or datafmfpgax[3:0] , datafmfpga[31:0] (dual-port mode)	O	<p>Depending on the OR3TP12 configuration, only one of these buses will be available to the FPGA application. For Master operations, these buses will carry the same information, but in different sizes and different bit lanes as summarized below:</p> <table border="0"> <thead> <tr> <th></th> <th>Quad-Port Mode</th> <th>Dual-Port Mode</th> </tr> </thead> <tbody> <tr> <td>a. Master Command. Control data decoded by the Master Controller and FIFO interface</td> <td></td> <td></td> </tr> <tr> <td>Repeat Burst Length:</td> <td>mwwdata[17]</td> <td>datafmfpgax[3]</td> </tr> <tr> <td>Dual-Address Indication:</td> <td>mwwdata[16]</td> <td>datafmfpgax[2]</td> </tr> <tr> <td>Unused:</td> <td>mwwdata[15:13]</td> <td>datafmfpga[31:29]</td> </tr> <tr> <td>Holding Reg. Selector:</td> <td>mwwdata[12]</td> <td>datafmfpga[28]</td> </tr> <tr> <td>Master Rd. Byte Enables:</td> <td>mwwdata[11:4]</td> <td>datafmfpga[27:20]</td> </tr> <tr> <td>Master Command Code:</td> <td>mwwdata[3:0]</td> <td>datafmfpga[19:16]</td> </tr> <tr> <td>b. Master Start Address: 32- or 64-bit PCI start address.</td> <td></td> <td></td> </tr> <tr> <td>Unused:</td> <td>mwwdata[17:16]</td> <td>datafmfpgax[3:0]</td> </tr> <tr> <td>Address:</td> <td>mwwdata[15:0]</td> <td>datafmfpga[31:0]</td> </tr> <tr> <td>c. Master Read Burst Count (18 bits): Number of 64-bit words.</td> <td></td> <td></td> </tr> <tr> <td>Burst Length[17:16]:</td> <td>mwwdata[17:16]</td> <td>datafmfpgax[1:0]</td> </tr> <tr> <td>Burst Length[15:0]:</td> <td>mwwdata[15:0]</td> <td>datafmfpga[15:0]</td> </tr> <tr> <td>d. Master Write Data: Write data to PCI bus.</td> <td></td> <td></td> </tr> <tr> <td>Write Enables:</td> <td>mwwdata[17:16]</td> <td>datafmfpgax[3:0]</td> </tr> <tr> <td>Data:</td> <td>mwwdata[15:0]</td> <td>datafmfpga[31:0]</td> </tr> </tbody> </table>		Quad-Port Mode	Dual-Port Mode	a. Master Command. Control data decoded by the Master Controller and FIFO interface			Repeat Burst Length:	mwwdata[17]	datafmfpgax[3]	Dual-Address Indication:	mwwdata[16]	datafmfpgax[2]	Unused:	mwwdata[15:13]	datafmfpga[31:29]	Holding Reg. Selector:	mwwdata[12]	datafmfpga[28]	Master Rd. Byte Enables:	mwwdata[11:4]	datafmfpga[27:20]	Master Command Code:	mwwdata[3:0]	datafmfpga[19:16]	b. Master Start Address: 32- or 64-bit PCI start address.			Unused:	mwwdata[17:16]	datafmfpgax[3:0]	Address:	mwwdata[15:0]	datafmfpga[31:0]	c. Master Read Burst Count (18 bits): Number of 64-bit words.			Burst Length[17:16]:	mwwdata[17:16]	datafmfpgax[1:0]	Burst Length[15:0]:	mwwdata[15:0]	datafmfpga[15:0]	d. Master Write Data: Write data to PCI bus.			Write Enables:	mwwdata[17:16]	datafmfpgax[3:0]	Data:	mwwdata[15:0]	datafmfpga[31:0]	fclk*
	Quad-Port Mode	Dual-Port Mode																																																				
a. Master Command. Control data decoded by the Master Controller and FIFO interface																																																						
Repeat Burst Length:	mwwdata[17]	datafmfpgax[3]																																																				
Dual-Address Indication:	mwwdata[16]	datafmfpgax[2]																																																				
Unused:	mwwdata[15:13]	datafmfpga[31:29]																																																				
Holding Reg. Selector:	mwwdata[12]	datafmfpga[28]																																																				
Master Rd. Byte Enables:	mwwdata[11:4]	datafmfpga[27:20]																																																				
Master Command Code:	mwwdata[3:0]	datafmfpga[19:16]																																																				
b. Master Start Address: 32- or 64-bit PCI start address.																																																						
Unused:	mwwdata[17:16]	datafmfpgax[3:0]																																																				
Address:	mwwdata[15:0]	datafmfpga[31:0]																																																				
c. Master Read Burst Count (18 bits): Number of 64-bit words.																																																						
Burst Length[17:16]:	mwwdata[17:16]	datafmfpgax[1:0]																																																				
Burst Length[15:0]:	mwwdata[15:0]	datafmfpga[15:0]																																																				
d. Master Write Data: Write data to PCI bus.																																																						
Write Enables:	mwwdata[17:16]	datafmfpgax[3:0]																																																				
Data:	mwwdata[15:0]	datafmfpga[31:0]																																																				
Master Read Data FIFO Signals																																																						
mrdataenn	O	Master Read FIFO Data Output Enable. This active-low signal enables data from the Master read data FIFOs onto bus mrdata (quad-port mode) or datatofpga (dual-port mode, fifo_sel = 0). mrdataenn must never be asserted if the Master read FIFO is empty (mr_emptyn = 0)	fclk*																																																			
mrdata[17:0] (quad-port mode) or datatofpgax[3:0] , datatofpga[31:0] (dual-port mode)	I	<p>Depending on the OR3TP12 configuration, only one of these buses will be available to the FPGA application. For Master operations, these buses will carry the same information, but in different sizes as summarized below:</p> <table border="0"> <thead> <tr> <th></th> <th>Quad-Port Mode</th> <th>Dual-Port Mode (fifo_sel = 0)</th> </tr> </thead> <tbody> <tr> <td>Master Read Data (16/32 bits)</td> <td></td> <td></td> </tr> <tr> <td>Unused:</td> <td>mrdata[17:16]</td> <td>datatofpgax[3:0]</td> </tr> <tr> <td>Data:</td> <td>mrdata[15:0]</td> <td>datatofpga[31:0]</td> </tr> </tbody> </table>		Quad-Port Mode	Dual-Port Mode (fifo_sel = 0)	Master Read Data (16/32 bits)			Unused:	mrdata[17:16]	datatofpgax[3:0]	Data:	mrdata[15:0]	datatofpga[31:0]	fclk*																																							
	Quad-Port Mode	Dual-Port Mode (fifo_sel = 0)																																																				
Master Read Data (16/32 bits)																																																						
Unused:	mrdata[17:16]	datatofpgax[3:0]																																																				
Data:	mrdata[15:0]	datatofpga[31:0]																																																				
mr_aemptyn	I	Master Read Data FIFO Almost Empty. This active-low signal indicates that only four more 64-bit data locations are available to be read from the Master read data FIFO.	fclk*																																																			
mr_emptyn	I	Master Read Data FIFO Empty. This active-low signal indicates that the Master read data FIFO is empty. mrdataenn should never be asserted when mr_emptyn is active.	fclk*																																																			
mrlastcycn	I	Master Read Last Data Cycle. This active-low signal is asserted to indicate that the accompanying Master read data is the final data word for this operation. mrdataenn must be asserted to receive mrlastcycn .	fclk*																																																			

* The source of the clock (**fclk1** or **fclk2**) for the FIFO interface (Master or Target) is selected in the FPSC configuration manager.

PCI Bus Core Detailed Description (continued)

Table 6. Embedded Core/FPGA Interface Signals (continued)

Symbol	I/O	Description	Clock Domain
Master Read Data FIFO Signals (continued)			
mr_stopburstn	○	Stop Burst Reads. This active-low signal is used by the FPGA application to terminate Master reads before the read burst length is reached. The Master must be transferring data on the PCI bus for this signal to be effective, and it is recommended to hold this signal until ma_fulln is deasserted. Once asserted, this signal needs to remain asserted for a minimum of two pciclk cycles.	pciclk
Target General			
tfifoclrn	○	Target FIFO Clear. This active-low signal is asynchronously asserted by the FPGA application to clear the Target address, read, and write data FIFOs, along with tstatecntr . This signal does not reset the Target controller's PCI state machine, and it is not recommended to be used to terminate the current PCI transaction.	—
t_ready		Target Logic Ready. This active-high signal indicates that the Target FIFO interface to the FPGA application is ready. This signal will be inactive during PCI bus resets, Target FIFO clears, and up to 16 clocks after device configuration. This signal can be ignored when transferring data from the Target write data FIFO, if pci_rstn is inactive.	fclk*
tstatecntr[3:0]		Target State Counter. Indicates the current state of the Target FIFO interface. Details of the Target FIFO interface can be found in the PCI Bus Core Target Controller Detailed Description section of this data sheet.	fclk*
disctimerexpn		Discard Timer Expired. This active-low signal indicates that the discard timer has expired and the Target controller has deleted the current transaction which was stored as a delayed transaction. The FPGA application should discontinue processing of the current Target transaction. The discard timer is a 15-bit counter which starts its count when the Target transaction is stored.	fclk*
t_abort	○	Target Abort. This signal is asserted by the FPGA application to abort future PCI Target and Configuration cycles. Once asserted, this signal needs to remain asserted for a minimum of two pciclk cycles.	pciclk
t_retryn	○	Target Retry. This active-low signal is asserted by an FPGA application to retry future PCI Target and Configuration cycles. Once asserted, this signal needs to remain asserted for a minimum of two pciclk cycles.	pciclk
deltrn	○	Target Read Delayed Transaction. Active-low signal which indicates to process certain future PCI Target accesses as delayed transactions. This applies to memory reads, I/O reads, and I/O writes. Further description is provided in Table 3 for each PCI operation. deltrn must be asserted if trburstpendn is deasserted. Once asserted, this signal needs to remain asserted for a minimum of two pciclk cycles and should not be changed while a current Target transaction is in progress.	pciclk

* The source of the clock (**fclk1** or **fclk2**) for the FIFO interface (Master or Target) is selected in the FPSC configuration manager.

PCI Bus Core Detailed Description (continued)

Table 6. Embedded Core/FPGA Interface Signals (continued)

Target FIFO Address and Command Register Control Signals																					
treqn		Target Request from PCI. The Target asserts treqn as an indication to the FPGA application that a PCI Target operation has been decoded and is pending. treqn signal will continue to be active until all data has been transferred between the FPGA application and the Target FIFO interface. The FPGA application should use treqn to qualify valid data on following buses: tcmd , bar , twdata (quad-port mode), and datatofpga/datatofpgax (dual-port mode)	fclk*																		
taenn	0	Target Address Output Enable. This active-low signal enables the PCI start address to be transferred from the Target address FIFO to the FPGA application, on either bus twdata (quad-port mode) or datatofpga (dual-port mode, fifo_sel = 1). treqn will be asserted to indicate a valid PCI Target address exists.	fclk*																		
tcmd[3:0]		Target Command Code. This bus provides the PCI command code for a pending Target operation, and is valid when treqn is asserted active-low.	—																		
bar[2:0]		Base Address Register Number. This bus indicates which of the six BARs decoded the PCI address for the current Target operation, and is valid when treqn is active-low. For 64-bit addresses, the BARs pairs will be indicated by numbers 0, 2, and 4.	—																		
Target Write Data FIFO Signals																					
twdataenn	0	Target Write FIFO Data Enable. This active-low signal enables data from the Target write data FIFO onto bus twdata (quad-port mode) or datatofpga (dual-port mode, fifo_sel = 1). twdataenn should not be asserted whenever the Target write data FIFO is empty (tw_emptyn = 0).	fclk*																		
twdata[17:0] (quad-port mode) or datatofpgax[3:0] , datatofpga[31:0] (dual-port mode)		Depending on the OR3TP12 configuration, only one of these buses will be available to the FPGA application. For Target operations, these buses will carry the same information, but in different sizes and bit lanes as summarized below: <div style="text-align: center;"> <u>Quad-Port Mode</u> <u>Dual-Port Mode</u> (fifo_sel = 1) </div> <p>a. Target Start Address: 32- or 64-bit PCI start address.</p> <table style="width: 100%; border: none;"> <tr> <td style="width: 30%;">Address:</td> <td style="width: 35%;">twdata[15:0]</td> <td style="width: 35%;">datatofpga[31:0]</td> </tr> <tr> <td>Dual-Address Indication:</td> <td>twdata[16]</td> <td>datatofpgax[0]</td> </tr> <tr> <td>Burst Indication:</td> <td>twdata[17]</td> <td>datatofpgax[1]</td> </tr> <tr> <td>Unused:</td> <td></td> <td>datatofpgax[3:2]</td> </tr> </table> <p>b. Target Write Data: Write data from PCI bus.</p> <table style="width: 100%; border: none;"> <tr> <td style="width: 30%;">Data:</td> <td style="width: 35%;">twdata[15:0]</td> <td style="width: 35%;">datatofpga[31:0]</td> </tr> <tr> <td>Write Enables:</td> <td>twdata[17:16]</td> <td>datatofpgax[3:0]</td> </tr> </table>	Address:	twdata[15:0]	datatofpga[31:0]	Dual-Address Indication:	twdata[16]	datatofpgax[0]	Burst Indication:	twdata[17]	datatofpgax[1]	Unused:		datatofpgax[3:2]	Data:	twdata[15:0]	datatofpga[31:0]	Write Enables:	twdata[17:16]	datatofpgax[3:0]	fclk*
Address:	twdata[15:0]	datatofpga[31:0]																			
Dual-Address Indication:	twdata[16]	datatofpgax[0]																			
Burst Indication:	twdata[17]	datatofpgax[1]																			
Unused:		datatofpgax[3:2]																			
Data:	twdata[15:0]	datatofpga[31:0]																			
Write Enables:	twdata[17:16]	datatofpgax[3:0]																			
tw_emptyn		Target Write FIFO Almost Empty. This active-low signal indicates that only four more 64-bit data locations are available to be read from the Target write data FIFO.	fclk*																		
tw_emptyn		Target Write FIFO Empty. This active-low signal indicates that the Target write FIFO is empty. twdataenn should never be asserted if tw_emptyn is asserted.	fclk*																		

* The source of the clock (**fclk1** or **fclk2**) for the FIFO interface (Master or Target) is selected in the FPSC configuration manager.

PCI Bus Core Detailed Description (continued)

Table 6. Embedded Core/FPGA Interface Signals (continued)

Symbol	I/O	Description	Clock Domain
Target Write Data FIFO Signals (continued)			
twlastcycn	I	Target Write Last Data Cycle. This active-low signal has two functions: a. Indicates that the current Target start address data on twdata (quad-port) or datatofpga (dual-port with fifo_sel = 1) is the final transfer of the address phase. taenn is required to be asserted to receive twlastcycn . b. Indicates that the current Target write data on twdata (quad-port) or datatofpga (dual-port with fifo_sel = 1) is the final transfer of the data phase. For single data transfers, it will be asserted on the only word of the transfer, whereas on bursts, it will be asserted only on the final word. twdataenn is required to be asserted to receive twlastcycn .	fclk*
twburstpendn	O	Burst Write Data Control. This active-low signal indicates to the Target controller that a write transaction should not be disconnected immediately when the Target write data FIFO is full, but allow up to eight wait-states to be inserted. When desasserted, the Target controller will disconnect when the write FIFOs are full. Once asserted, this signal needs to remain asserted for a minimum of two pciclk cycles.	pciclk
Target Read Data FIFO Signals			
trdataenn	O	Target Read FIFO Data Enable. This active-low signal enables the registering of bus trdata (quad-port mode) or datafmfpga (dual-port mode) into the Target read data FIFO. trdataenn should not be asserted when the Target read data FIFO is full (tr_fulln = 0).	fclk*
trdata[17:0] (quad-port mode) or datafmfpga[31:0], datafmfpgax[3:0] (dual-port mode)	O	Depending on the OR3TP12 configuration, only one of these buses will be available to the FPGA application. For Target operations, these buses will carry the same information, but in different sizes as summarized below: Target Read Data: Read data to the PCI bus. Data: trdata[15:0] datafmfpga[31:0] Unused: trdata[17:16] datafmfpgax[3:0]	fclk*
tr_afulln	I	Target Read FIFO Almost Full. This active-low signal indicates that the Target read data FIFO has only four more 64-bit empty locations available.	fclk*
tr_fulln	I	Target Read FIFO Full. This active-low signal indicates that the Target read data FIFO is full and that no more data can be accepted. trdataenn must not be asserted when tr_fulln is asserted.	fclk*
trlastcycn	I	Target Read Last Data Cycle. This active-low signal is asserted to indicate the final cycle of the read data phase. During read bursts, more than one clock is usually required to transfer a complete data phase; therefore, this signal will be asserted only on the last data word. During a read burst, trlastcycn may remain inactive for longer than it is required by the external Master, leading to transfer of excess data into the Target read data FIFO. All excess data will be cleared when the external Master terminates the transaction. trlastcycn will only be active only with an asserted trdataenn .	fclk*

* The source of the clock (**fclk1** or **fclk2**) for the FIFO interface (Master or Target) is selected in the FPSC configuration manager.

PCI Bus Core Detailed Description (continued)

Table 6. Embedded Core/FPGA Interface Signals (continued)

Symbol	I/O	Description	Clock Domain
Target Read Data FIFO Signals (continued)			
trpcihold	○	Target Read PCI Bus Hold. For read transfers to the PCI bus, this signal delays the start of the data transfer (i.e., trdyn assertion). The data transfer will begin when trpcihold is deasserted or the Target read data FIFO becomes full. Once asserted, this signal needs to remain asserted for a minimum of two pciclk cycles.	pciclk
trburstpendn	○	Target Read Burst Control. This active-low signal directs the Target to insert up to eight wait-states between subsequent read data phases before disconnect. When deasserted, the Target will disconnect immediately when the Target read data FIFO becomes empty. If deltrn is inactive, trburstpendn must be driven active. Once asserted, this signal needs to remain asserted for a minimum of two pciclk cycles.	pciclk
Miscellaneous Signals			
pci_intan	○	PCI Interrupt Request. This active-low signal is used to generate a PCI bus interrupt and is forwarded by the embedded core as intan onto the PCI bus. Once asserted, this signal needs to remain asserted for a minimum of two pciclk cycles.	—
fclk1 fclk2	○ ○	FPGA Clock 1 and 2. Clocks used by the Master and Target FIFO interface logic. fclk1 and fclk2 need to be activated for use by the Master and Target in the FPSC configuration manager. In dual-port mode, only one of these clocks may be active, while the other should be tied low.	—
pciclk		PCI Clock. pciclk is a buffered version of clk for use by the FPGA application as the main clock, or for control signals which are in the pciclk domain (such as t_retryn , mr_stopburstn , etc.). The FPGA may route pciclk to any of the FPGA resources, fclk1 or fclk2 , programmable clock managers, etc.	—
pci_rstn		PCI Reset. This active-low signal indicates that a PCI bus reset was received from the PCI bus (rstn).	—
fpga_syserror	○	System Error. This pin is used by the FPGA to generate a system error on the PCI bus. This is passed to the PCI bus as serrn . Once asserted, this signal needs to remain asserted for a minimum of two pciclk cycles.	pciclk

* The source of the clock (**fclk1** or **fclk2**) for the FIFO interface (Master or Target) is selected in the FPSC configuration manager.

PCI Bus Core Detailed Description (continued)

Table 6. Embedded Core/FPGA Interface Signals (continued)

Symbol	I/O	Description	Clock Domain
Miscellaneous Signals (continued)			
cfgshiftenn pci_cfg_stat	O I	<p>PCI Error Status Control</p> <p>cfgshiftenn is an active-low signal that MUXes the output of the PCI device status register (PCI Specification 2.1: Section 6.2.3) onto signal pci_cfg_stat:</p> <p>cfgshiftenn = 1: pci_cfg_stat outputs the wired-OR of all status bits below, after being masked by options in the FPSC configuration manager.</p> <p>cfgshiftenn = 0: pci_cfg_stat outputs each status bit below, shifted one at a time on successive pciclk rising edges. The shift register is reset when cfgshiftenn = 1.</p> <p>Device Status Register bits: Detected Parity Error, Signaled System Error, Received Master Abort, Received Target Abort, Signaled Target Abort, Master Data Parity Error.</p>	pciclk
pci_64bit	I	<p>PCI 64-Bit Bus Indication. This active-high signal indicates that the embedded core detected that it is configured as a 64-bit agent on the PCI bus. This is the result of detecting PCI signal req64n as active-low on the rising edge of PCI signal rstn. Note that this does not imply that any particular transaction is 64-bit, since each transaction is individually negotiated using PCI signals req64n and ack64n. When asserted, all data transfers across the Master and Target FIFO interface will imply 64-bit data phases.</p>	—
fifo_sel	O	<p>FIFO Select. A MUX control signal that is valid in the dual-port mode to select either Master read data (fifo_sel = 0) or Target address/write data (fifo_sel = 1) on the datatofpga and datatofpgax bus. For quad-port mode, this signal can be tied to high.</p>	—

* The source of the clock (**fclk1** or **fclk2**) for the FIFO interface (Master or Target) is selected in the FPSC configuration manager.

PCI Bus Core Detailed Description (continued)

Embedded Core/FPGA Interface Signal Locations

Table 7 lists the physical locations of all signals on the embedded core/FPGA interface. Separate names are provided for dual-port and quad-port bus signals, since their functionality is port mode dependent.

Table 7. OR3TP12 FPGA/PCI Core Interface Signal Locations

Embedded Core/FPGA Interface Site	FPGA Input Signal		FPGA Output Signal	
	Dual-Port Mode	Quad-Port Mode	Dual-Port Mode	Quad-Port Mode
PB1A	disctimerexpn		cfgshiftenn	
PB1B	t_ready		twburstpendn	
PB1C	pci_cfg_stat		(unused)	
PB1D	treqn		(unused)	
PB2A	datatofpga0	twdata0	datafmfpga0	trdata0
PB2B	datatofpga1	twdata1	datafmfpga1	trdata1
PB2C	datatofpga2	twdata2	datafmfpga2	trdata2
PB2D	datatofpga3	twdata3	datafmfpga3	trdata3
PB3A	datatofpga4	twdata4	datafmfpga4	trdata4
PB3B	datatofpga5	twdata5	datafmfpga5	trdata5
PB3C	datatofpga6	twdata6	datafmfpga6	trdata6
PB3D	datatofpga7	twdata7	datafmfpga7	trdata7
PB4A	datatofpga8	twdata8	datafmfpga8	trdata8
PB4B	datatofpga9	twdata9	datafmfpga9	trdata9
PB4C	datatofpga10	twdata10	datafmfpga10	trdata10
PB4D	datatofpga11	twdata11	datafmfpga11	trdata11
PB5A	datatofpga12	twdata12	datafmfpga12	trdata12
PB5B	datatofpga13	twdata13	datafmfpga13	trdata13
PB5C	datatofpga14	twdata14	datafmfpga14	trdata14
PB5D	datatofpga15	twdata15	datafmfpga15	trdata15
CKTOASB5	(unused)		fclk2	
PB6A	datatofpgax0	twdata16	datafmfpgax0	trdata16
PB6B	datatofpgax1	twdata17	datafmfpgax1	trdata17
PB6C	twlastcycn		twdataenn	
PB6D	trlastcycn		trdataenn	
PB7A	bar0		fpga_syserror	
PB7B	bar1		t_abort	
PB7C	bar2		t_retrypn	
PB7D	pciclk		taenn	
PB8A	tstatecntr0		(unused)	
PB8B	tstatecntr1		(unused)	
PB8C	tstatecntr2		(unused)	
PB8D	tstatecntr3		(unused)	

PCI Bus Core Detailed Description (continued)

Table 7. OR3TP12 FPGA/PCI Core Interface Signal Locations (continued)

Embedded Core/FPGA Interface Site	FPGA Input Signal		FPGA Output Signal	
	Dual-Port Mode	Quad-Port Mode	Dual-Port Mode	Quad-Port Mode
PB9A	tw_emptyn		trburstpendn	
PB9B	tw_aemptyn		tfifoclrn	
PB9C	tr_fulln		trpcihold	
PB9D	tr_fulln		pci_intan	
PB10A	tcmd0		mr_stopburstn	
PB10B	tcmd1		mfifoclrn	
PB10C	tcmd2		mwpcihold	
PB10D	tcmd3		mwlastcycn	
PB11A	ma_fulln		(unused)	
PB11B	fpga_msyserror		(unused)	
PB11C	mrlastcycn		(unused)	
PB11D	m_ready		(unused)	
PB12A	mw_fulln		maenn	
PB12B	mw_afulln		fifo_sel	
PB12C	mr_emptyn		fpga_mbusyn	
PB12D	mr_aemptynmrdata		deltrn	
PB13A	pci_rstn		mrdataenn	
PB13B	pci_64bit		mwdataenn	
PB13C	datatofpga2	mrdata16	datafmfpga2	mwdata16
PB13D	datatofpga3	mrdata17	datafmfpga3	mwdata17
CKTOASB13	(unused)		fclk1	
PB14A	datatofpga16	mrdata0	datafmfpga16	mwdata0
PB14B	datatofpga17	mrdata1	datafmfpga17	mwdata1
PB14C	datatofpga18	mrdata2	datafmfpga18	mwdata2
PB14D	datatofpga19	mrdata3	datafmfpga19	mwdata3
PB15A	datatofpga20	mrdata4	datafmfpga20	mwdata4
PB15B	datatofpga21	mrdata5	datafmfpga21	mwdata5
PB15C	datatofpga22	mrdata6	datafmfpga22	mwdata6
PB15D	datatofpga23	mrdata7	datafmfpga23	mwdata7
PB16A	datatofpga24	mrdata8	datafmfpga24	mwdata8
PB16B	datatofpga25	mrdata9	datafmfpga25	mwdata9
PB16C	datatofpga26	mrdata10	datafmfpga26	mwdata10
PB16D	datatofpga27	mrdata11	datafmfpga27	mwdata11
PB17A	datatofpga28	mrdata12	datafmfpga28	mwdata12
PB17B	datatofpga29	mrdata13	datafmfpga29	mwdata13
PB17C	datatofpga30	mrdata14	datafmfpga30	mwdata14
PB17D	datatofpga31	mrdata15	datafmfpga31	mwdata15
PB18A	mstatecntr0		(unused)	
PB18B	mstatecntr1		(unused)	
PB18C	mstatecntr2		(unused)	
PB18D	mstatecntr3		(unused)	

PCI Bus Core Detailed Description (continued)

Embedded Core Configuration Options

Table 8 lists all options in the embedded core that can be selected via the FPSC configuration manager. The table also lists the settings available for each option, which is accessible using the FPSC design kit software.

Table 8. PCI Bus Core Options Settable via FPGA Configuration RAM Bits

Description	Hex Address in PCI Configuration Space	Optional Settings
Revision ID	0x08	Any 8-bit value.
Class Code	0x09—0x0B	Any 24-bit value.
Bus Master Support	0x4: Bit 2	Three options: <ul style="list-style-type: none"> ■ Target Only: Powerup value: 0; Access Type: Read-only ■ Master/Target: Powerup value: 0; Access Type: Read/Write ■ Master: Powerup value: 1; Access Type: Read-only
Data Parity Error Detected	0x4: Bit 8	Mask value for wire-OR output pci_cfg_stat .
Target Abort Signal	0x4: Bit 11	Mask value for wire-OR output pci_cfg_stat .
Target Abort Received	0x4: Bit 12	Mask value for wire-OR output pci_cfg_stat .
Master Abort Received	0x4: Bit 13	Mask value for wire-OR output pci_cfg_stat .
System Error Signaled	0x4: Bit 14	Mask value for wire-OR output pci_cfg_stat .
Parity Error Detected	0x4: Bit 15	Mask value for wire-OR output pci_cfg_stat .
Latency Timer Initial Value	0x0D	Any 8-bit value divisible by eight (XXXXX000).
Base Address Register (BAR0/1) Area 1	0x10—0x17	<ul style="list-style-type: none"> ■ Refer to PCI Specification 2.2, Section 6.2.5.1 ■ Up to two 32-bit BARs, one 64-bit BAR, or none (i.e., unprogrammed). ■ 32-bit BARs can Target memory or I/O space. ■ Memory can be prefetchable or nonprefetchable. ■ If 64-bit BAR, must be memory; page size can be from 2^4 bytes to 2^{64} bytes. ■ If 32-bit I/O BAR, page size can be from 2^2 bytes to 2^{32} bytes. ■ If 32-bit memory BAR, address space can be 2^4 bytes to the maximum (2^{20} bytes or 2^{32} bytes).
Base Address Register (BAR2/3) Area 2	0x18—0x1F	Same as for BAR area 1.
Base Address Register (BAR4/5) Area 3	0x20—0x27	Same as for BAR area 1.

PCI Bus Core Detailed Description (continued)

Table 8. PCI Bus Core Options Settable via FPGA Configuration RAM Bits (continued)

Description	Hex Address in PCI Configuration Space	Optional Settings
Subsystem Vendor ID	0x2C—0x2D	Any 16-bit value.
Subsystem ID	0x2E—0x2F	Any 16-bit value.
Minimum Grant (Min_Gnt)	0x3E	Any 8-bit value.
Maximum Latency (Max_Lat)	0x3F	Any 8-bit value.
Port Mode		Dual-port or quad-port.
I/O Mode		Fast or slow-limited PCI output buffers.
Master FIFO Interface Clock		fclk1 or fclk2 .
Target FIFO Interface Clock		fclk1 or fclk2 .
Target Address Comparator		Enabled or disabled; when enabled, the Target FIFO interface will not transfer the MSB of the Target address to the FPGA application, if it matches the value of the previous transferred address. For dual-port, the MSB will cover bits [64:32], whereas for quad-port, the MSB represents bits [64:17]. If disabled, the FPGA application will receive the address covering the decoded BAR space.
Target Maximum Initial Latency		Normal (16) or extended (32): The number of wait-states to insert on Target reads until valid data is recognized in the Target read data FIFOs. If no data is detected, the Target will disconnect. Note that only normal initial latency complies with PCI Specification 2.2, Section 3.5.1.1. Extended latency may be specified in proprietary systems where additional clocks are required to return the first data word.

ALL DEVELOPMENTS DISCONTINUED

PCI Bus Core Detailed Description (continued)

Embedded Core/FPGA FIFO Interface Operation Summary

The following sections describe the Master and Target FIFO interface operation between the PCI bus core and the FPGA application. Table 9 is an index to the state tables and timing figures provided for each of the operational modes (dual-port, quad-port) of the FIFO interface.

Table 9. Index to State Sequence Tables

Master/ Target	PCI Access Type	Address Type	Single/Burst and Delayed/ Nondelayed	PCI Bus Timing Figure	Dual-Port Mode		Quad-Port Mode						
					State Table	FPGA Bus Timing Figure	State Table	FPGA Bus Timing Figure					
Master	Write	Config, Memory, I/O	Single	5	13	3	14	4					
			Burst	8					6	7			
	Read	Config, Memory, I/O	Single	11	15	9	16	10					
			Burst	14					12	17	13		
Target	Write	Config	Single	15	20	*	21	*					
			I/O	Single, Delayed					—	18	19		
		Memory		Single, Nondelayed					16	21	22		
			Burst	20									
		Read	Config	Single					23	22	*	23	*
				I/O					Delayed				
	Nondelayed		25										
	Memory		Single	29	31	32							
			Single, Delayed	26									
			Burst	33									
	Burst, Delayed	30											

* The FPGA interface does not participate in Target configuration operations.

PCI Bus Core Master Controller Detailed Description

FIFO Interface Overview

The Master FIFO interface consists of two transfer phases: command/address followed by data. This sequence must be followed, with the assertion of **mwlastcycn** indicating the completion of each phase. In both quad- and dual-port modes, the command is transferred first, followed by address, then data. The PCI start address and bus command are always provided by the FPGA application. For Master writes, write data with byte enables will be provided by the FPGA application, whereas for reads the Master will receive its data from the PCI bus and forward on to the FPGA application. All types of data are transferred on the data paths defined by the operational mode (dual- or quad-port).

Master State Counter

The Master FIFO interface provides a state counter, **mstatecntr[3:0]**, that informs the FPGA application of its current state (Table 12). This state counter determines what data is expected from the FPGA application during the command/address or write data phases, or what is currently being provided by the Master FIFO interface during read data phases. This state counter transitions from one state to another in a predetermined manner. Table 13 through Table 17 detail the sequencing of the **mstatecntr** and the data transferred for Master write and read transactions.

The value on bus **mstatecntr** can be used to minimize FPGA logic or verify proper operation. The data provided by the Master FIFO interface to the FPGA application is accompanied by a value on **mstatecntr[3:0]**, as shown in Table 12. This value can be directly used by the FPGA application to determine the proper orientation of the Master read data. This eliminates the need for logic in the FPGA application for possible data packing functions. The data required from the FPGA application by the Master FIFO interface during the command/address or write data is also defined by the value on **mstatecntr**. However, the state counter value being presented to the FPGA application is in the same cycle that the data is sent from the FPGA. Here, the value provided by the Master FIFO interface can be used to determine the next state, since current data, phase, enables, and state transitions is known.

Dual-Master Address Holding Registers

The Master FIFO interface utilizes a pair of 64-bit address holding registers to reduce latency when setting up repeated Master transfers to or from the same PCI address. Every Master command/address phase has associated with it one of the two holding registers, as specified by the holding register selector (Master command word bit 12, as described in Table 10). Each address holding register records the full previous address, allowing some, all, or none of that recorded address to be used to build the next address associated with that holding register. This can save up to 2/4 cycles (for dual-port/quad-port mode, respectively) during the command/address phase.

The holding register supplies the most significant portion, or all, or none, of the address. The amount supplied by the holding register is determined by the timing of the signal **mwlastcycn**, which accompanies the last portion of data during the command/address phase. If **mwlastcycn** accompanies the Master command word, the holding register supplies the entire address. Table 11 gives examples of typical operation using the holding registers, illustrating the above rules.

The holding registers can be partitioned using one each for read and write operations, thus providing two unrelated addresses for two functions. Another useful application is to dedicate one holding register to a fixed address such as the beginning of a buffer, the data port of a FIFO or a mailbox register. This increases effective bandwidth on shorter bursts.

PCI Bus Core Master Controller Detailed Description (continued)

Table 10. Bit Definitions for Master Command/Address Phase

Bits	Name	Description	Quad-Port	Dual-Port
Master Command Word (FPGA → PCI Core)				
17	SPL	Master Read: Same Previous Burst Length Indication (quad-port only) Master Write: Must Be Zero	mwdata[17]	datafmfpgax[3]
16	DA	Dual-Address Indication	mwdata[16]	datafmfpgax[2]
15:13	—	Not Used	mwdata[15:13]	datafmfpga[31:29]
12	HR	Holding Register Selector: 0 = Select HR0 1 = Select HR1	mwdata[12]	datafmfpga[28]
11:4	MRDBEN	Master Read: Byte Enables Master Write: Not Used	mwdata[11:4]	datafmfpga[27:20]
3:0	Cmd	PCI Command Code*	mwdata[3:0]	datafmfpga[19:16]
Master Read Burst Length Word (FPGA → PCI Core)				
17:16	BL	Burst Length of 64-bit Words	mwdata[17:16]	datafmfpgax[1:0]
15:0	BL	Burst Length of 64-bit Words	mwdata[15:0]	datafmfpga[15:0]
Master Address Word (FPGA → PCI Core)				
17:16	—	Not Used	mwdata[17:16]	datafmfpgax[1:0]
15:0	Adrs	Address	mwdata[15:0]	datafmfpga[31:0]

* Refer to PCI Specification 2.3 Section 3.1.

Master Write Operation

Command/Address Setup

In order to initiate a PCI Master write operation, the FPGA application must supply the Master command and PCI start address in the specific order prescribed in Table 13 and Table 14, for quad- and dual-port mode respectively. This data is transferred via bus **mwdata** (quad-port mode) or **datafmfpga(x)** (dual-port mode) and will be accepted by the Master FIFO interface when **ma_fulln** is inactive and **m_ready** is active. The Master command word and address must be accompanied by assertion of the enable **maenn**, with the command/address phase ending with the assertion of **mwlastcycn**. The bit definitions of the Master command word is shown in Table 10. For Master writes, the same burst length bit must be equal to zero.

All burst transactions or 64-bit agents (**pci_64bit** = 1) must start transactions on a 64-bit address boundary, which requires address bit **ad2** = 0 for the PCI start address. If the write transaction needs to start on a odd 32-bit address boundary (**ad2** = 1), the FPGA must send a padding data word to properly fill/align the Master write data FIFO at the beginning of the data phase. This padding data word will be the first write data word transferred from the FPGA application, and will have all of its byte enables deasserted. When the Master starts the PCI transaction on a 32-bit bus, this padding data word will be dropped by the Master, with the resulting transaction starting on the odd address (**ad2** = 1).

For single 32-bit transaction on 32-bit buses (**pci_64bit** = 0), the Master FIFO interface will perform the proper data alignment. The FPGA application will transfer the PCI starting address, even or odd, during the command/address phase and the valid 32-bit data word during the data phase.

PCI Bus Core Master Controller Detailed Description (continued)

Table 11. Holding Registers, Examples of Typical Operation

Address Transfer on Bus MWDData				mwlastcycn Valid With:	Holding Reg. Select	Holding Register 0 Initial Value				Holding Register 1 Initial Value				Master Start Address			
A3	A2	A1	A0			A3	A2	A1	A0	A3	A2	A1	A0	A3	A2	A1	A0
1111	1111	1111	1111	A3	0	xxxx	xxxx	xxxx	xxxx	xxxx	xxxx	xxxx	xxxx	1111	1111	1111	1111
—	—	—	2222	A0	0	1111	1111	1111	1111	xxxx	xxxx	xxxx	xxxx	1111	1111	1111	2222
0123	4567	89AB	CDEF	A3	1	1111	1111	1111	2222	xxxx	xxxx	xxxx	xxxx	0123	4567	89AB	CDEF
—	—	—	—	Cmd	0	1111	1111	1111	2222	0123	4567	89AB	CDEF	1111	1111	1111	2222
—	—	3333	4444	A1	0	1111	1111	1111	2222	0123	4567	89AB	CDEF	1111	1111	3333	4444
—	5555	6666	7777	A2	0	1111	1111	3333	4444	0123	4567	89AB	CDEF	1111	5555	6666	7777
8888	9999	AAAA	BBBB	A3	0	1111	5555	6666	7777	0123	4567	89AB	CDEF	8888	9999	AAAA	BBBB
—	—	—	—	Cmd	1	8888	9999	AAAA	BBBB	0123	4567	89AB	CDEF	0123	4567	89AB	CDEF
CCCC	DDDD	EEEE	FFFF	A3	1	8888	9999	AAAA	BBBB	0123	4567	89AB	CDEF	CCCC	DDDD	EEEE	FFFF
—	—	—	—	Cmd	0	8888	9999	AAAA	BBBB	CCCC	DDDD	EEEE	FFFF	8888	9999	AAAA	BBBB

Table 12. Master State Counter (MStateCntr) Values and the Corresponding Bus Data

MStateCntr[3:0]	Dual-Port Mode (32-Bit Ports)		Quad-Port Mode (16-Bit Ports)	
MStateCntr[3:0]	Data on Bus datafmfpga	Data on Bus datatofpga	Data on Bus mwdata	Data on Bus mrdata
0	BurstLength, Command Word	Read Data [31:0]	Command Word	Read Data [15:0]
1	Adrs[31:0]	Read Data [63:32]	BurstLength Adrs[15:0]*	Read Data [31:16]
2	Adrs[63:32]	—	Adrs[15:0] Adrs[31:16]*	Read Data [47:32]
3	—	—	Adrs[31:16] Adrs[47:32]*	Read Data [63:48]
4	—	—	Adrs[47:32] Adrs[63:48]*	—
5	—	—	Adrs[63:48]	—
6	—	—	Write Data [15:0]	—
7	—	—	Write Data [31:16]	—
8	—	—	Write Data [47:32]	—
9	—	—	Write Data [63:48]	—
A	Write Data [31:0]	—	—	—
B	Write Data [63:32]	—	—	—

* Same burst length specified in bit 17 of command word for Master reads, or Master write operation.

PCI Bus Core Master Controller Detailed Description (continued)

Write Data Phase

The FPGA application begins the write data phase by deasserting **maenn** and asserting **mwdataenn**. On every clock cycle that **mwdataenn** is asserted, the FPGA application will transfer write data and its associated byte enables into the Master write data FIFO (sixty-four 32-bit words; thirty-two 64-bit words) via bus **mwdata** (quad-port mode) or **datafmfpga** (dual-port mode). **mwdataenn** must not be asserted when the write data FIFOs are full (**mw_fulln** is asserted). Note that **mw_fulln** can be updated on the same clock edge as **mwdataenn** is sampled.

The distinction between a burst write and a single access is provided by the **mwlastcycn** signal instead of using a burst length. This allows the FPGA application to maintain control over the length of the Master write burst. When **mwlastcycn** is asserted, this informs the Master FIFO interface of the end of the write data phase. **mwlastcycn** will be deasserted for every data element except the last element on bus **mwdata** (quad-port mode) or **datafmfpga** (dual-port mode). **mwlastcycn** can remain asserted throughout a single (non-burst) Master write. For example, to perform a single 32-bit word transfer in dual-port mode, **mwlastcycn** would be asserted during the entire data phase, since the last data phase is the only data phase. Note if **mwlastcycn** is asserted, **mwdataenn** must be asserted.

When executing a burst Master write or on a 64-bit bus (**pci_64bit** = 1), the write data transferred from the FPGA application is aligned on 64-bit address boundaries, which may require padding of write data to properly fill/align the write data FIFOs. For transfers starting at an odd 32-bit PCI address (**ad2** = 1), this will require a 32-bit padding data word at the beginning of the write data phase. Padding of FIFO is accomplished by transferring a data word with its byte enables deasserted. In 64-bit transfers, the padding word will be placed on the a 32-bit segment with its byte enables deasserted and the external Target will ignore it. For 32-bit wide data transfers, this padding word will be ignored and not transferred to the PCI bus.

For single 32-bit transaction on 32-bit buses (**pci_64bit** = 0), the Master FIFO Interface will perform the proper data alignment. The FPGA application only needs to transfer the valid 32-bit data word during the data phase.

FIFO Full/Almost Full

When the Master write data FIFO contains four or fewer 64-bit empty locations, the Master FIFO interface asserts **mw_afulln**, the almost full indicator. This allows some latency to exist in the FPGA's response without risking overflowing the FIFO. When all locations in the Master write data FIFO are full, the Master FIFO interface asserts **mw_fulln**, the FIFO full indicator. Since data can be simultaneously written to and read from the Master write FIFO, both **mw_afulln** and **mw_fulln** can change states in either direction multiple times in the course of a burst transfer.

Master Write Hold

The signal **mwpcihold** can be asserted to delay the initiation of a Master write operation, i.e., **reqn** asserted, until a greater amount of data is available in the write data FIFOs. Normally, the Master write operation would begin after the first write data word is received by the Master FIFO interface. While **mwpcihold** is active, write data can be transferred from the FPGA application into the write FIFOs. When the Master write FIFOs become full or **mwpcihold** is deasserted, the Master write operation will begin on the PCI bus (**reqn** asserted). **mwpcihold** must be deasserted at least two **pciclk**s before **mwlastcycn** is asserted, which indicates the end of the write data phase.

Use of this signal can result in more efficient utilization of PCI bus bandwidth by causing a full buffer contents to be bursted, without wait-states, after the PCI bus is claimed.

Wait-States

The Master will not insert wait-states into a write transfer, as long as the Master write data FIFO is nonempty. If the Master write data FIFO becomes empty before **mwlastcycn** was asserted by the FPGA application, wait-states will be inserted until more write data is provided or the external Target disconnects. If the FPGA application cannot provide subsequent data to the Master write data FIFO within an eight **pciclk** period, it is recommended to end the data phase by asserting **mwlastcycn** and **mwdataenn**, along with a valid data word, to avoid excessive wait-states insertion.

PCI Bus Core Master Controller Detailed Description (continued)

Termination

Once initiated, Master write operations will continue on the PCI bus until either all write data is sent, an abort occurs (either Master or Target), or the PCI bus' reset signal (**rstn**) is asserted. During aborts, the Master address and write data FIFOs will be cleared, and the FPGA application will be notified by the assertion of **fpga_msyserror**.

If the Master write transaction is terminated with a retry or disconnected by the external Target before all data has been transferred, the Master will initiate another Master write operation, continuing from that point using a stored address pointer.

On the Master FIFO interface, the FPGA application identifies the last data word by asserting **mwlascygn**. When this data word is transferred to the PCI bus, the Master will terminate the PCI transaction normally. The Master will inform the FPGA application of completion by deasserting **ma_fulln**.

Reset

The FPGA application can apply a reset signal to place the Master FIFO interface logic in a known state, which clears all FIFOs and **mstatecntr**. The reset signal, **mfifoclrn**, is asynchronous and therefore should be asserted for a minimum of one clock cycle and deasserted for a minimum of one clock cycle before continuing. This is not recommended to assert **mfifoclrn** while a current PCI transaction is in progress (**ma_fulln** asserted), since proper PCI bus termination is not guaranteed. Only PCI **rstn** will reset the internal Master PCI state machines, while a PCI transaction is in progress.

ALL DEVICES DISCONTINUED

PCI Bus Core Master Controller Detailed Description (continued)

Example: Master Write, Single-Word Transaction

Figure 3 and Figure 4 shows the timing of a Master write, single 32-bit data word, on the dual-port FPGA interface and quad-port FPGA interface, respectively. In Figure 3, the command/address phase is initiated by the FPGA application asserting Master address enable (**maenn**), while providing the Master command word on bus **datafmfpga**. On the next clock, the FPGA application provides the 32-bit address and ends the command/address phase by asserting **mwlastcycn** for the write data phase.

To enter the data phase, **maenn** is deasserted, **mwdataenn** is asserted, and a valid 32-bit Dword of data provided on bus **datafmfpga**. For a 32-bit transfer on a 32-bit PCI bus (**pci_64bit = 0**), the FPGA application asserts the signal **mwlastcycn** during the only clock of the data phase. After the first write data word is provided, **ma_fulln** goes active indicating the Master will begin negotiating for the PCI bus.

For quad-port mode (Figure 4), the command/address and write data is transferred on the bus **mwdata** in 16-bit segments. The 18-bit Master command will remain unchanged, but the 32-bit address will be split into two 16-bit components with the LSB being transferred first. The command/address phase will require three clock cycles (**maenn** asserted), and **mwlastcycn** will be asserted on the final or MSB component of the address.

The data phase will also require additional clock cycles to transfer the 32-bit write data word across the bus **mwdata**. Similar to above, the data phase will be entered with the deassertion of **maenn** and assertion of **mwdataenn**. **mwlastcycn** will be deasserted for the initial 16-bit LSB of the write data word and asserted for the final 16-bit MSB component.

In Figure 5, execution begins on the PCI bus which shows the timing of a transaction with an external Target. The transaction results in a normal completion. It is a typical PCI transaction with a remote Target that supports fast decode, and the protocol and timing are as required by the PCI Specification.

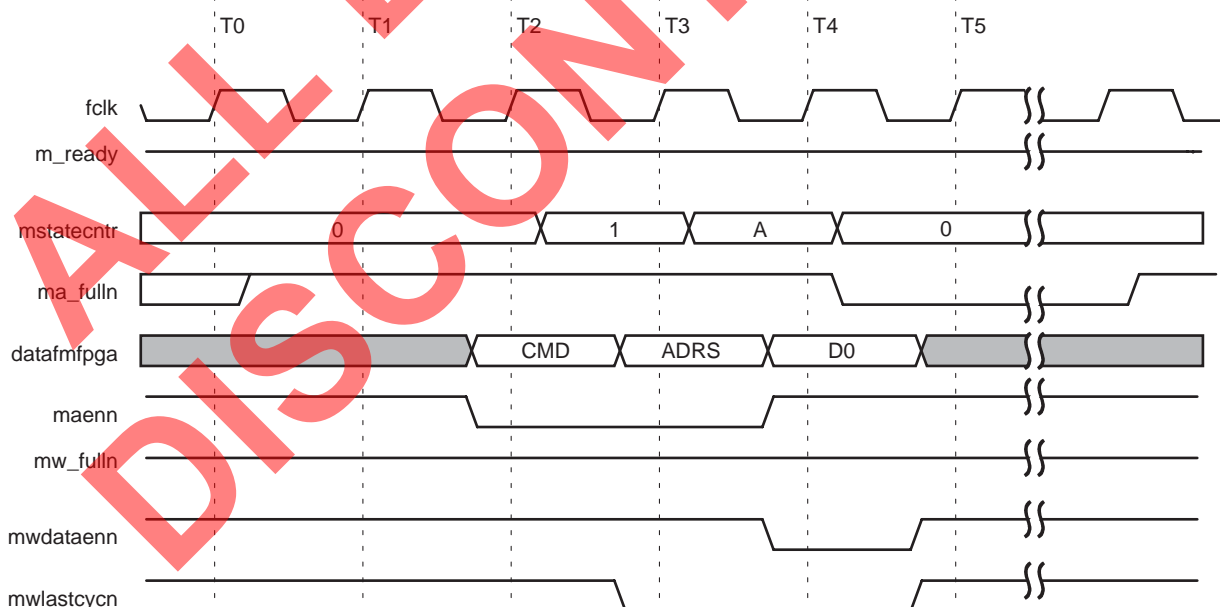

5-7350(F)

Figure 3. Master Write Single (FIFO Interface, Dual-Port)

PCI Bus Core Master Controller Detailed Description (continued)

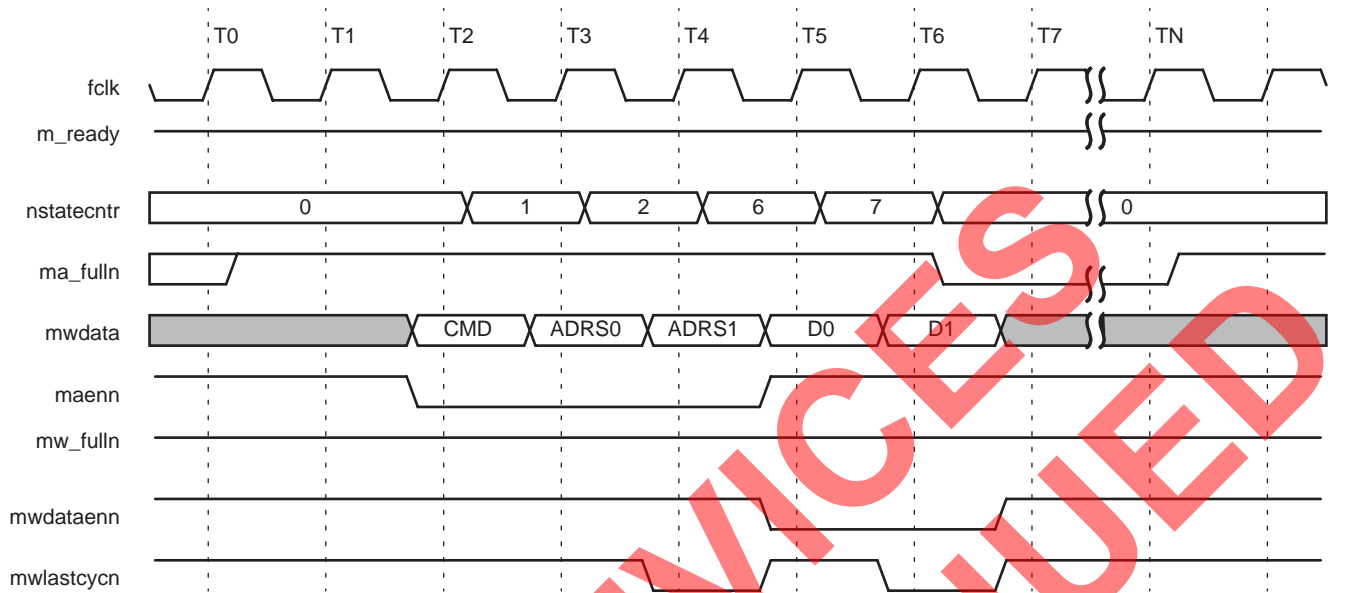

5-7358(F)

Figure 4. Master Write Single (FIFO Interface, Quad-Port)

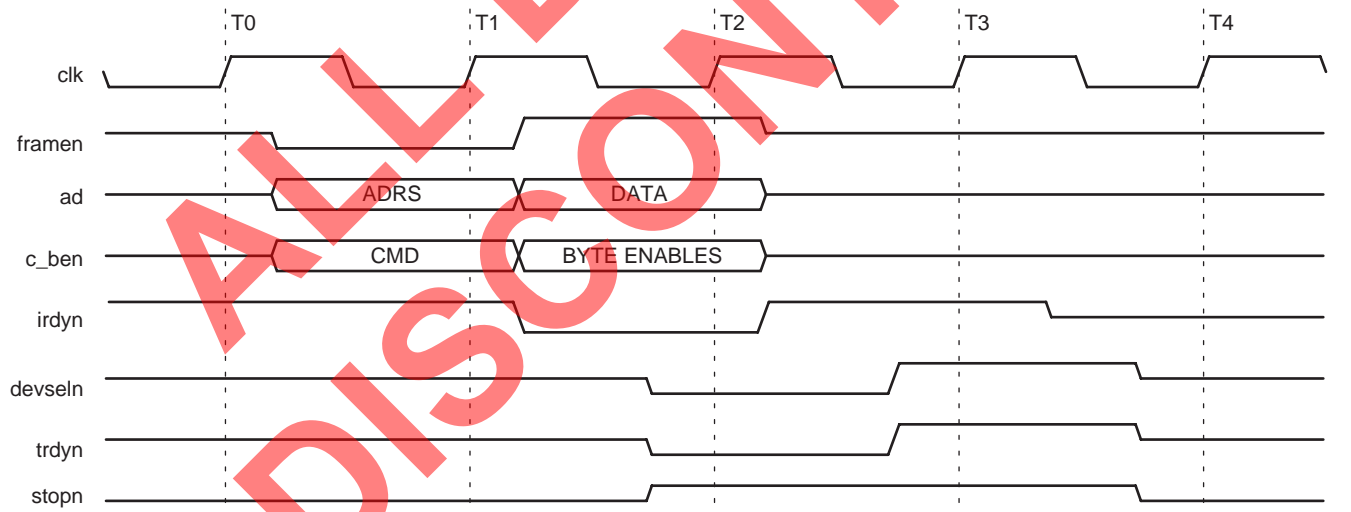

5-7366(F)

Figure 5. Master Write Single (PCI Bus, 32-Bit)

PCI Bus Core Master Controller Detailed Description (continued)

Example: Master Write, Burst Transaction

Figure 6 and Figure 7 show the timing of a Master write of four 32-bit data words, on the dual-port FPGA interface and quad-port FPGA interface, respectively. In Figure 6, the command/address phase is initiated by the FPGA application asserting Master address enable (**maenn**), while providing the Master command word on bus **datafmfpga**. On the next clock, the FPGA application provides the 32-bit address and ends the command/address phase by asserting **mwlastcycn**.

To enter the data phase, **maenn** is deasserted, **mwdataenn** is asserted, and a valid 32-bit Dword of data provided on bus **datafmfpga**. After the second write data word is provided, **ma_fulln** goes active indicating the Master will begin negotiating for the PCI bus (assuming **mwpcihold** is deasserted). The FPGA application continues to supply data (three 32-bit Dwords) on bus **datafmfpga** with **mwdataenn** asserted, while monitoring the **mw_fulln** flag. To indicate the completion of the data phase, **mwlastcycn** is asserted, along with **mwdataenn**, during the final data word.

For quad-port mode (Figure 7), the command/address and write data is transferred on the bus **mwdata**. The 18-bit Master command will remain unchanged, but the 32-bit address will be split into two 16-bit components with the LSB being transferred first. The command/address phase will require three clock cycles (with **maenn** asserted), and **mwlastcycn** will be asserted on the final or MSB component of the address.

The quad-port data phase will also require additional clock cycles to transfer the four 32-bit write data word across the bus **mwdata**. Similar to above, the data phase will be entered with the deassertion of **maenn** and assertion of **mwdataenn**. **mwlastcycn** will be deasserted for all write data words, except being asserted for the final 16-bit MSB component.

Execution begins on the PCI bus, as shown in Figure 8, which shows the timing with an external Target. The transaction runs to normal completion. It is a typical PCI transaction (the remote Target supports fast decode), and the protocol and timing are as required by the PCI Specification.

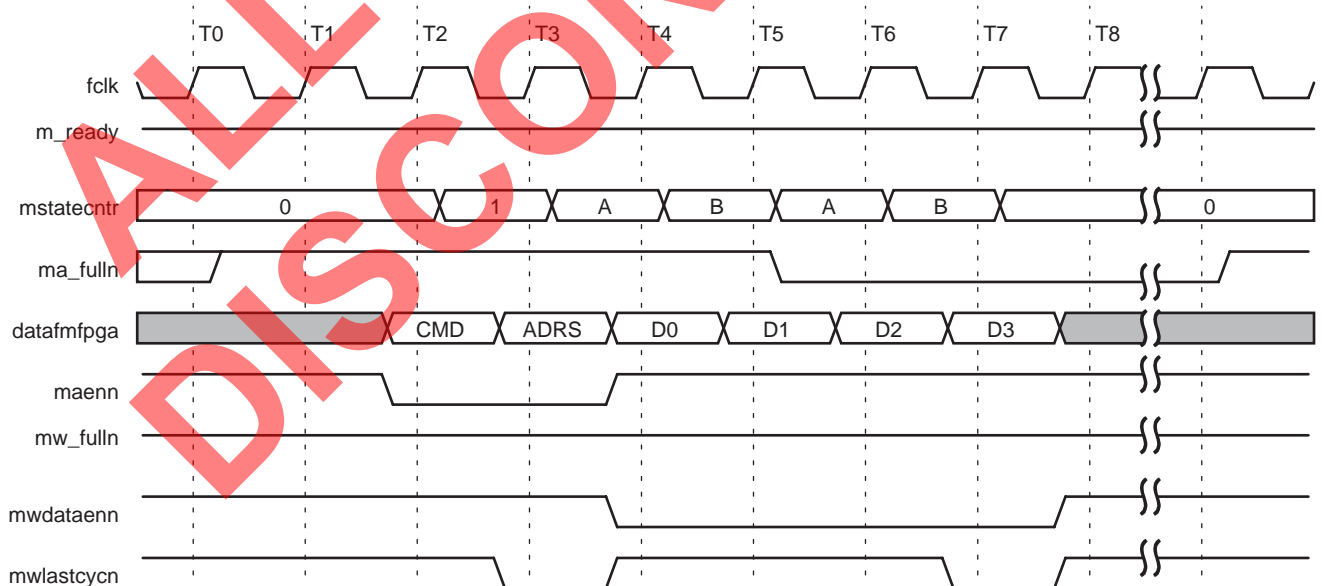

5-7351(F)

Figure 6. Master Write Burst (FIFO Interface, Dual-Port)

PCI Bus Core Master Controller Detailed Description (continued)

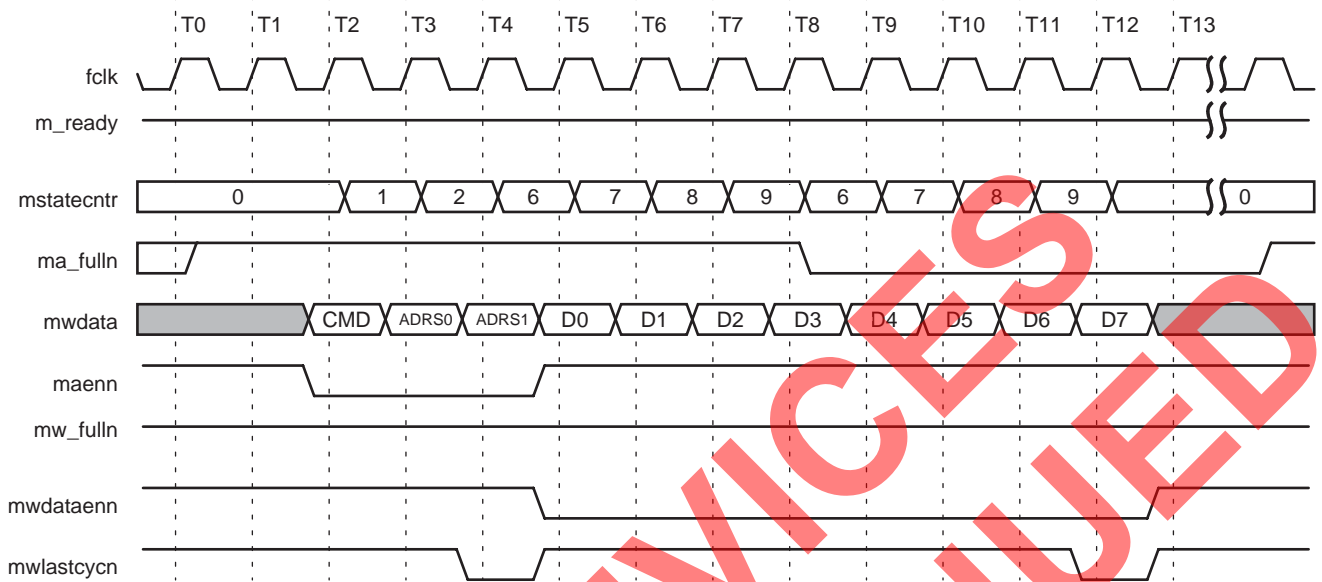

5-7359(F)

Figure 7. Master Write Burst (FIFO Interface, Quad-Port)

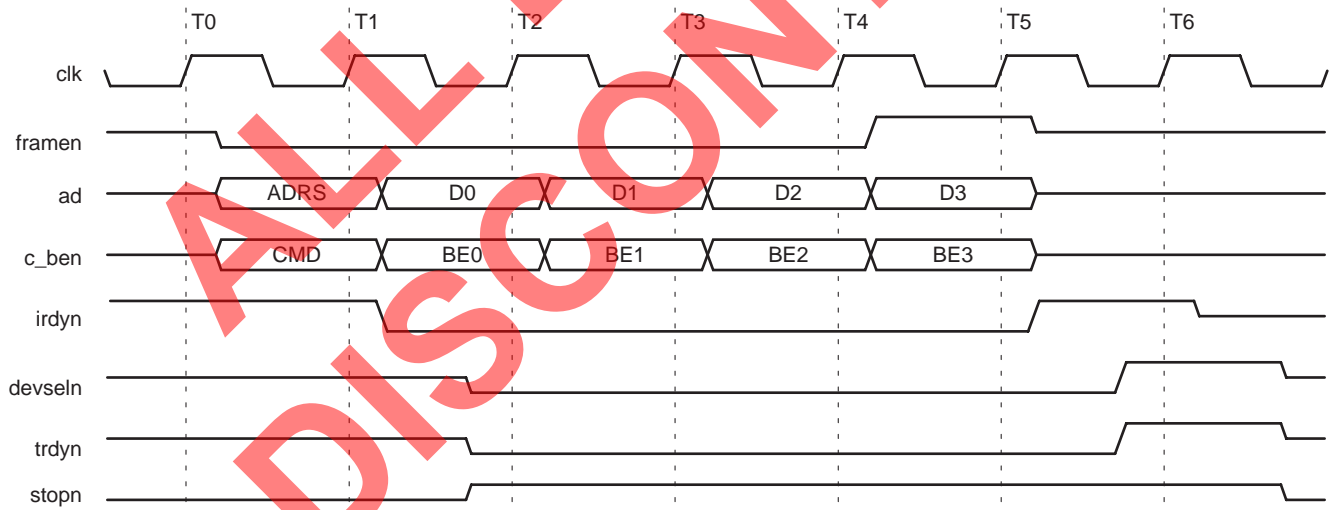

5-7367(F)

Figure 8. Master Write Burst (PCI Bus, 32-Bit)

PCI Bus Core Master Controller Detailed Description (continued)

Table 13. Dual-Port Master Writes

MStateCntr	Next State of MStateCntr	Description	Data on Bus datafmfpgax[3:0], datafmfpga[31:0]	Notes
0	0	Idle	XXXX ₄ , XXXX ₁₆	1
0	1 or A	Command Word	Command Word [17:16], XX ₂ , Command Word [15:0], XXXX ₁₆	2, 3, 6
1	2 or A	Address[31:0]	XXXX ₄ , PCIAddress[31:0]	2, 3, 6
2	A	Address[63:32]	XXXX ₄ , PCIAddress[63:32]	2, 3, 6
A	B or 0	Data[31:0]	BEN[3:0], PCIData[31:0]	4, 5
B	A or 0	Data[63:32]	BEN[7:4], PCIData[63:32]	4, 5

1. When **maenn** and **ma_fulln** are deasserted high, the Master interface is idle.
2. When **maenn** is asserted low, a command/address phase is in progress.
3. **maenn** must be asserted low for command/address data to transfer and state to change.
4. **maenn** must be deasserted high and **mwdataenn** must be asserted low to execute the data phase and state to change.
5. Next state = 0 if **mwlastcycn** is asserted low (end of Master write data phase).
6. Next state = A if **mwlastcycn** is asserted low (end of Master command/address phase).

Table 14. Quad-Port Master Writes

MStateCntr	Next State of MStateCntr	Description	Data on Bus mwdata[17:0]	Notes
0	0	Idle	XX ₂ , XXXX ₁₆	1
0	1 or 6	Command Word	Command Word	2, 3, 6
1	2 or 6	Address[15:0]	XX ₂ , PCIAddress[15:0]	2, 3, 6
2	3 or 6	Address[31:16]	XX ₂ , PCIAddress[31:16]	2, 3, 6
3	4 or 6	Address[47:32]	XX ₂ , PCIAddress[47:32]	2, 3, 6
4	6	Address[63:48]	XX ₂ , PCIAddress[63:48]	2, 3, 6
6	7	Data[15:0]	BEN[1:0], PCIData[15:0]	4
7	8 or 0	Data[31:16]	BEN[3:2], PCIData[31:16]	4, 5
8	9	Data[47:32]	BEN[5:4], PCIData[47:32]	4
9	6 or 0	Data[63:48]	BEN[7:6], PCIData[63:48]	4, 5

1. When **maenn** and **ma_fulln** are deasserted high, the Master interface is idle.
2. When **maenn** is asserted low, a command/address phase is in progress.
3. **maenn** must be asserted low for command/address data to transfer and state to change.
4. **maenn** must be deasserted high and **mwdataenn** must be asserted low to execute the data phase and state to change.
5. Next state = 0 if **mwlastcycn** is asserted low (end of Master write data phase).
6. Next state = 6 if **mwlastcycn** is asserted low (end of Master command/address phase).

Master Read Operation

Command/Address Setup

In order to initiate a PCI Master read operation, the FPGA application must supply the Master command, Master read burst length, and PCI start address in the specific order prescribed in Table 15 and Table 17, for quad- and dual-port mode respectively. The bit definitions of the Master command word are shown in Table 10. This data is transferred via bus **mwdata**

(quad-port mode) or **datafmfpga** (dual-port mode), and cannot be accepted by the Master FIFO interface unless **ma_fulln** is inactive and **m_ready** is active. The Master command word, Master read burst length, and start address must be accompanied by assertion of the enable **maenn**, with the command/address phase ending with the assertion of **mwlastcycn**. After the command/address phase completes, **ma_fulln** goes active indicating the Master will begin negotiating for the PCI bus.

PCI Bus Core Master Controller Detailed Description (continued)

The Master uses the read burst count supplied during command/address phase to determine number of 64-bit words the Master read operation should transfer (unlike the Master write, which uses signal **mwlastcycn**). If the burst length for a Master read operation is the same as for the previous Master operation, the FPGA application may elect to set bit 17 of the Master command word. In this case, no burst length is supplied; and the read burst length from the previous operation is used. This saves a clock cycle during the command/address phase when in quad-port mode, but should remain zero for the dual-port mode.

All read transactions require an address on a 64-bit boundary, which requires **ad2** = 0. The read burst length will indicate the number 64-bit words to retrieve from this address. All burst read transaction may transfer twice the read burst length of 32-bit words on a 32-bit PCI bus (**pci_64bit** = 0). On a 64-bit PCI bus (**pci_64bit** = 1), the number of transfers may equal the read burst length. All read byte enables in the Master command word must be asserted for a burst read transaction.

Single 32-bit transactions require a burst length of one. For single 32-bit reads on a 32-bit PCI bus (**pci_64bit** = 0), the read byte enables MRDBEN[7:0] can modify the start address. Using MRDBEN[7:0] = x0f will not modify the start address, whereas MRDBEN[7:0] = x0f will. For example on a 32-bit data bus (**pci_64bit** = 0), a read transaction with an even 64-bit starting address and read byte enables of 0x0f will retrieve a 32-bit word at the starting address + 0x4. For the case of read byte enables of 0xf0, the 32-bit word will be retrieved from the starting address.

Read Data Phase Transfer

The FPGA application begins the read data phase by deasserting **maenn** and asserting **mrdataenn**. On every cycle that **mrdataenn** is asserted and **fifo_sel** is deasserted, the FPGA application will receive read data from the Master read FIFO (sixty-four 32-bit words; thirty-two 64-bit words) via bus **mrdata** (quad-port mode) or **datatofpga** (dual-port mode), providing the read data FIFOs are not empty (**mr_emptyn** = 1). No byte enables are collected from the PCI bus, and therefore **mrdata[17:16]** and **datatofpgax[3:0]** will be unused. **mrdataenn** must not be asserted when the read data FIFOs are empty (**mr_emptyn** is asserted). Note that **mr_emptyn** can be updated on the same clock edge as **mrdataenn** is sampled.

The distinction between a burst read and a single access is provided by the read burst length count and the Master read byte enables. When the read burst is greater than one, or has all of its read byte enables asserted with **pci_64bit** = 0, it informs the Master of a burst read data phase for 32-bit PCI buses. During bursts, **mrlastcycn** will be deasserted for every data element received from the Master FIFO interface while **mrdataenn** is asserted (**fifo_sel** is deasserted), except the last element. For a single 32-bit word transfer in dual-port mode on a 32-bit PCI bus (**pci_64bit** = 0), **mrlastcycn** would be asserted during the entire data phase, since the last data phase is the only data phase of this transfer. Note that for **mrlastcycn** to be asserted, **mrdataenn** must be asserted.

When executing a burst Master read, or with 64-bit agents (**pci_64bit** = 1), the read data transferred to the FPGA application is always aligned on 64-bit address boundaries, which may require transfer of extra read data for activity on 32-bit PCI buses. For read transfers from an odd 32-bit PCI address (**ad2** = 1), this will imply receiving an extra 32-bit read data word from the PCI bus at the beginning of the read data phase. For transfers starting at an even PCI address (**ad2** = 0) requiring an odd number of 32-bit data words, an extra 32-bit read data word is received at the end. The extra read data can be discarded by the FPGA application.

For single 32-bit transactions, on 32-bit buses (**pci_64bit** = 0), the Master FIFO interface will perform the proper data alignment. The FPGA application only needs to transfer the valid 32-bit word during the data phase.

Master Read Data FIFO Empty/Almost Empty

When the Master read data FIFO contains four or fewer 64-bit data elements, the Master FIFO interface asserts **mr_aemptyn**, the almost empty indicator. This allows some latency to exist in the FPGA's response without risking overreading the FIFO. When all locations in the Master read data FIFO are empty, the Master FIFO interface asserts **mr_emptyn**, the FIFO empty indicator. Since data can be simultaneously written to and read from the Master read FIFO, both **mr_aemptyn** and **mr_emptyn** can change states in either direction multiple times in the course of a burst data transfer.

PCI Bus Core Master Controller Detailed Description (continued)

Master Read Byte Enables

During Master reads, read byte enables are always supplied by the Master to the external Target, even though on reads the data is flowing in the opposite direction. Thus, the byte enables cannot be buffered in the read data FIFO alongside the corresponding data.

Also, the byte enables must be presented on the bus by the Master at the same time that the data is being presented on the bus by the external Target (unless the external Target uses **trdyn** to insert wait-states). The data provided by the external Target cannot depend on the byte enables unless wait-states are inserted. Since the byte enables are not buffered, they are defined in the Master command word (bits [11:4]) and are held static throughout the read transaction. Their polarity is active-low assertion.

For burst read transactions, the read byte enables must all be asserted. Burst read transactions on a 32-bit agent (**pci_64bit** = 0) are defined with a burst length of one or greater, and the read byte enables MRDBEN[7:0] asserted. Mixed read byte enables are not allowed for bursting, but are allowed for single accesses. Single accesses for a 32-bit PCI bus (**pci_64bit** = 0) are defined with a read burst length of one, and the either of the following combination of read byte enables: MRDBEN[7:4] = 0xf or MRDBEN[3:0] = 0xf. For 64-bit single access (**pci_64bit** = 1, read burst length = 1), any combination of the read byte enables is valid.

Wait-States

The Master will only insert wait-states into a read transaction when the Master read data FIFO is full, the burst length count has not been reached, and Target is not disconnecting. If the FPGA application cannot receive data from the Master read data FIFOs within an eight **pciclk** period, it is recommended to end the read transaction by asserting **mr_stopburstn** and **mrdataen**, while storing the valid read data word, to avoid excessive wait-state insertion.

Read Transaction Termination

Once initiated, Master read operations will repeat on the PCI bus until all data is received, an abort occurs (either Master or Target), the PCI bus' reset signal (**rstn**) is asserted, or **mrstopburstn** is asserted. On an abort, the Master address FIFO is cleared, but the Master read data FIFO will continue to hold all data

received before the abort. The Master read data FIFO must be emptied before starting a new Master transaction.

mrstopburstn can be used by the FPGA application to terminate a Master read transaction before the read burst length has been reached. This signal is only effective if the Master can receive data from an external Target (**irdyn** and **framen** asserted). Since the FPGA application has no visibility of the PCI bus control signals, **mrstopburstn** should be held active until **ma_fulln** is deasserted.

On the Master FIFO interface, **mrlastcycn** indicates when the last item of the read transaction is being transferred, although the transaction may have ended earlier. The transaction on the PCI bus that has been terminated by Master is indicated by **ma_fulln** being deasserted.

If a PCI transaction is terminated with a retry or disconnect before all data has been received, the PCI bus core will initiate another Master read operation, continuing from that point.

Master Read FIFO Interface Reset

The FPGA application can apply a reset signal to place the Master FIFO interface in a known state, which clears all FIFOs and resets the **mstatecntr**. The reset signal, **mfifoclrn**, is asynchronous and therefore should be asserted for a minimum of one clock cycle and deasserted for a minimum of one clock cycle before continuing. It is not recommended to assert **mfifoclrn** while a current PCI transaction is in progress (**ma_fulln** asserted), since proper PCI bus termination is not guaranteed. Only **rstn** will reset the internal Master PCI state machines, while a PCI transaction is in progress.

Example: Master Read, Single-Word Transaction

Figure 9 and Figure 10 show the timing of a Master read, single 32-bit data word, on the dual-port FPGA interface and quad-port FPGA interface, respectively. In Figure 9, the command/address phase is initiated by the FPGA application asserting Master address enable (**maenn**), while providing the Master command word and read burst length on bus **datafmfpga**. Assuming the Master will decode the supplied burst length of one, 32-bit PCI bus width (**pci_64bit** = 0), and read byte enable (MRDBEN[7:0] = 0xf0), this is a single operation. On the next clock, the FPGA application provides the 32-bit address and ends the command/address phase by asserting **mwlascycn**. **ma_fulln** then will be asserted, and the Master will begin negotiating for the PCI bus.

PCI Bus Core Master Controller
Detailed Description (continued)

To enter the dual-port data phase, **maenn** is deasserted, **mrdataenn** is asserted, **fifo_sel** is deasserted, and a valid 32-bit word of data will be provided on bus **datatofpga**, providing the read data FIFO is not empty (**mr_emptyn** = 1). For a 32-bit transfer on a 32-bit PCI bus (**pci_64bit** = 0), the Master FIFO interface will assert the signal **mrlastcycn** during the only clock of the data phase. The completion of the data phase is indicated by **mrlastcycn** being asserted, requiring **mrdataenn** asserted, and the final data word.

For quad-port mode (Figure 10), the command/address phase starts with the command and read burst length transferring on the bus **mwdata** in sequential 18-bit segments. The 18-bit Master command will be transferred first on **mwdata**, followed the 18-bit read burst length, with both validated by an asserted **maenn**. The 32-bit address will be split into two 16-bit components

with the LSB being transferred first, also validated by an asserted **maenn**. The command/address phase will require four clock cycles, and **mwlastcycn** will be asserted on the final or MSB component of the address.

In the data phase of the quad-port mode, the read data will be transferred in 16-bit segments on bus **mrdata**. The read data phase will require two clock cycles to transfer the 32-bit read data word across the 16-bit bus **mrdata**, providing **mrdataen** is asserted, and the read data FIFOs are not empty (**mr_emptyn** = 1). **mrlastcycn** will be deasserted for the first 16-bit LSB of the read data word, and asserted for the final 16-bit MSB component.

Following this command/address setup, execution begins on the PCI bus. Figure 11 shows the timing of a typical transaction with a remote Target. The transaction results in a normal completion. The remote Target supports fast decode, and the protocol and timing are as required by the PCI Specification.

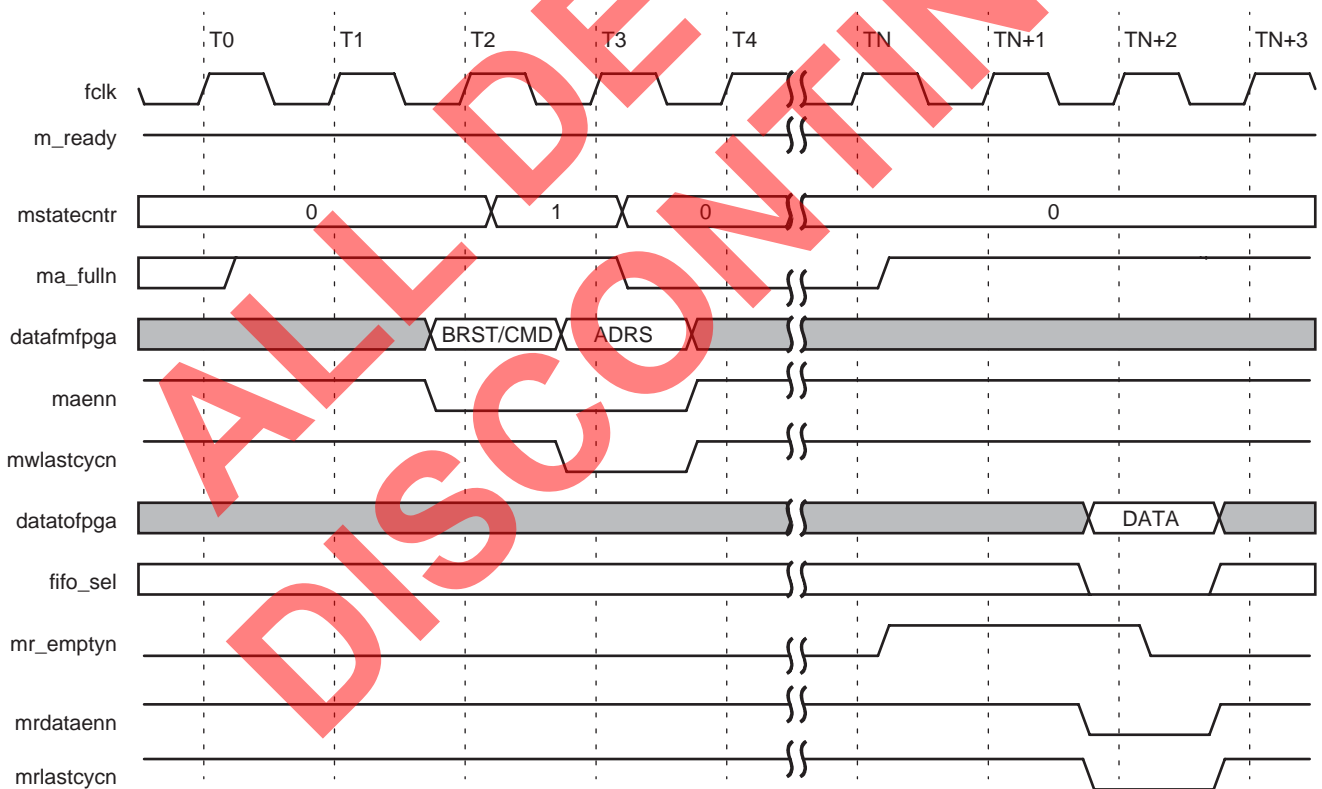

5-7352(F)

Figure 9. Master Read Single (FIFO Interface, Dual-Port)

PCI Bus Core Master Controller Detailed Description (continued)

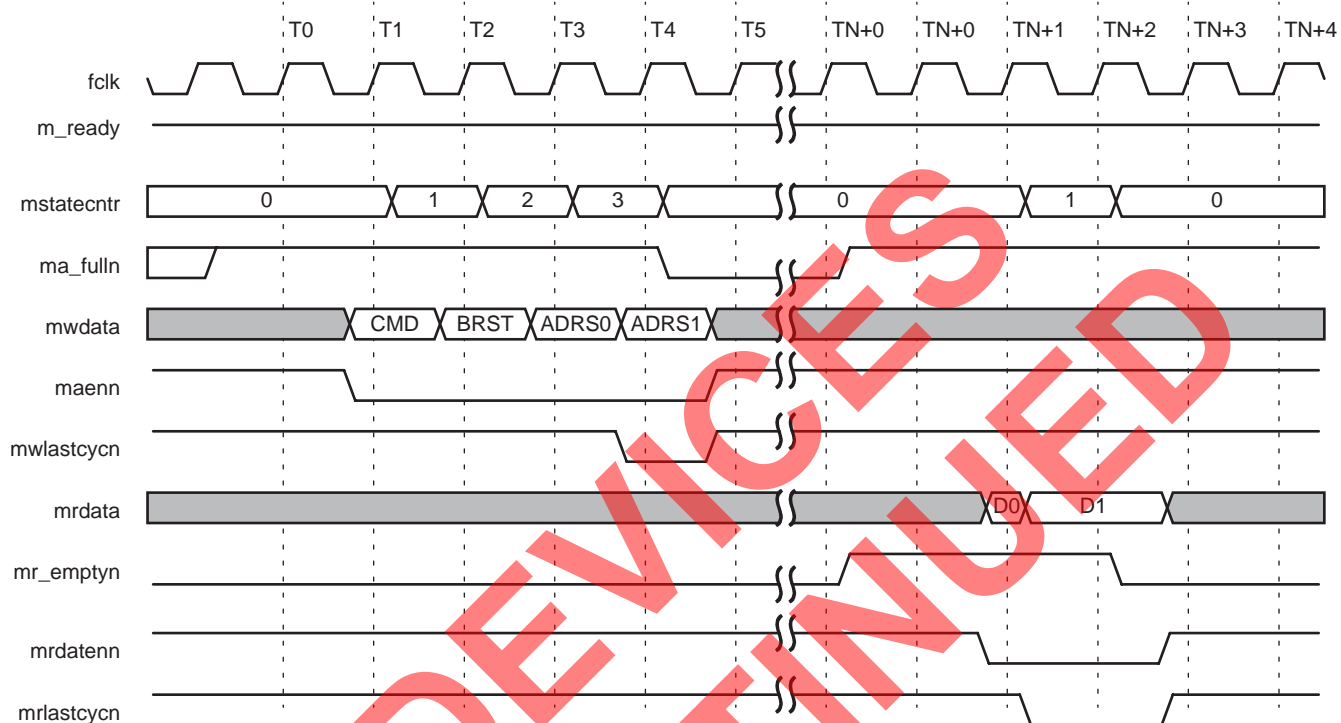

5-7360(F)

Figure 10. Master Read Single (FIFO Interface, Quad-Port)

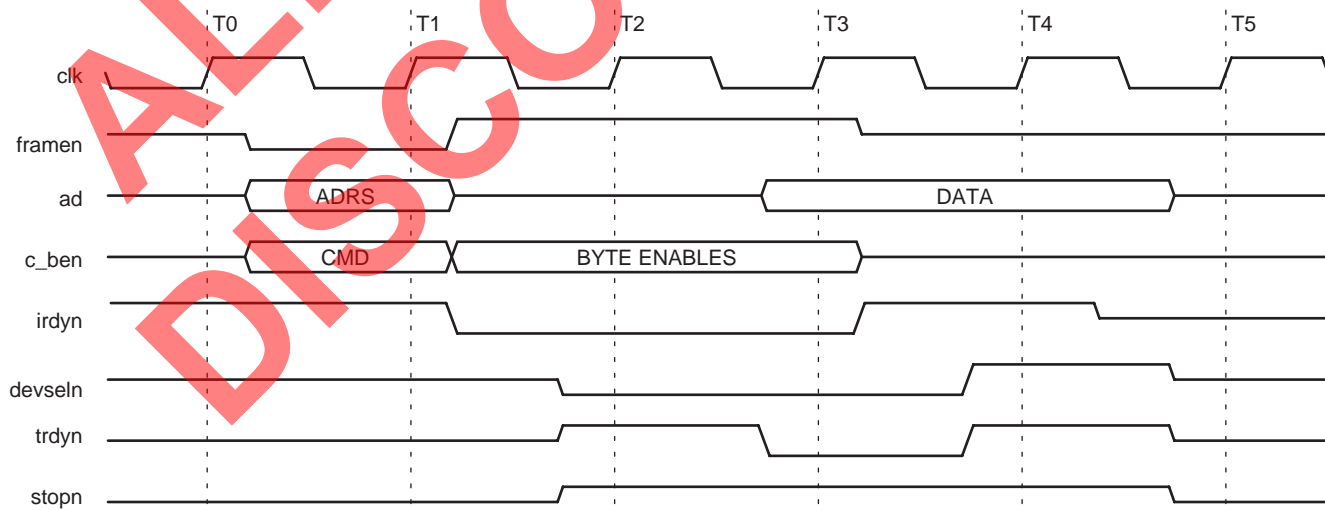

5-7368(F)

Figure 11. Master Read Single (PCI Bus, 32-Bit)

PCI Bus Core Master Controller Detailed Description (continued)

Example: Master Read, Burst Transaction

Figure 12 and Figure 13 show the timing of a four 32-bit word Master burst read, on the dual-port FPGA interface and quad-port FPGA interface, respectively. Operation is similar to that in the Master read, single-word transaction, but extra data Dwords are requested by the FPGA application. In Figure 12, the command/address phase is initiated by the FPGA application asserting Master address enable (**maenn**), while providing the Master command word and read burst length on bus **datafmfpga**. Assuming, the Master will decode a supplied burst length of two, and read byte enable (**MRDBEN[7:0] = 0x00**), this is a burst operation. On the next clock, the FPGA application provides the 32-bit address and ends the command/address phase by asserting **mwlastcycn**. **ma_fulln** then will be asserted, and the Master will begin negotiating for the PCI bus.

To enter the dual-port read data phase, **maenn** is deasserted, **mrdataenn** is asserted, and valid 32-bit data words will be provided on bus **datatofpga** (**fifo_sel = 0**), providing the read data FIFO is not empty (**mr_emptyn = 1**). For a burst transfer, the Master FIFO interface will assert the signal **mrlastcycn** during the last clock of the data phase, and deasserted otherwise. The completion of the data phase is indicated by **mrlastcycn** asserted, requiring **mrdataenn**

asserted, and the final data word.

For quad-port mode (Figure 13), the command/address phase starts with the command and read burst length transferring on the bus **mwdata** in sequential segments. The 18-bit Master command will be transferred first on **mwdata**, followed the 18-bit read burst length, with both validated by an asserted **maenn**. The 32-bit address will be split into two 16-bit components with the LSB being transferred first, also validated by an asserted **maenn**. The command/address phase will require four clock cycles, and **mwlastcycn** will be asserted on the final or MSB component of the address.

In the read data phase of the quad-port mode, the read data will be transferred in 16-bit segments on bus **mrdata**. The read data phase will require two clock cycles to transfer each 32-bit read data word across the 16-bit bus **mrdata**, providing **mrdataen** is asserted, the read data FIFOs are not empty (**mr_emptyn = 1**). **mrlastcycn** will be deasserted for the all cycles of the data phase, and asserted for final the 16-bit MSB component.

Following this command/address setup, execution begins on the PCI bus. Figure 14 shows the timing of a typical transaction with a remote Target. The transaction results in a normal completion. The remote Target supports fast decode, and the protocol and timing are as required by the PCI Specification.

PCI Bus Core Master Controller Detailed Description (continued)

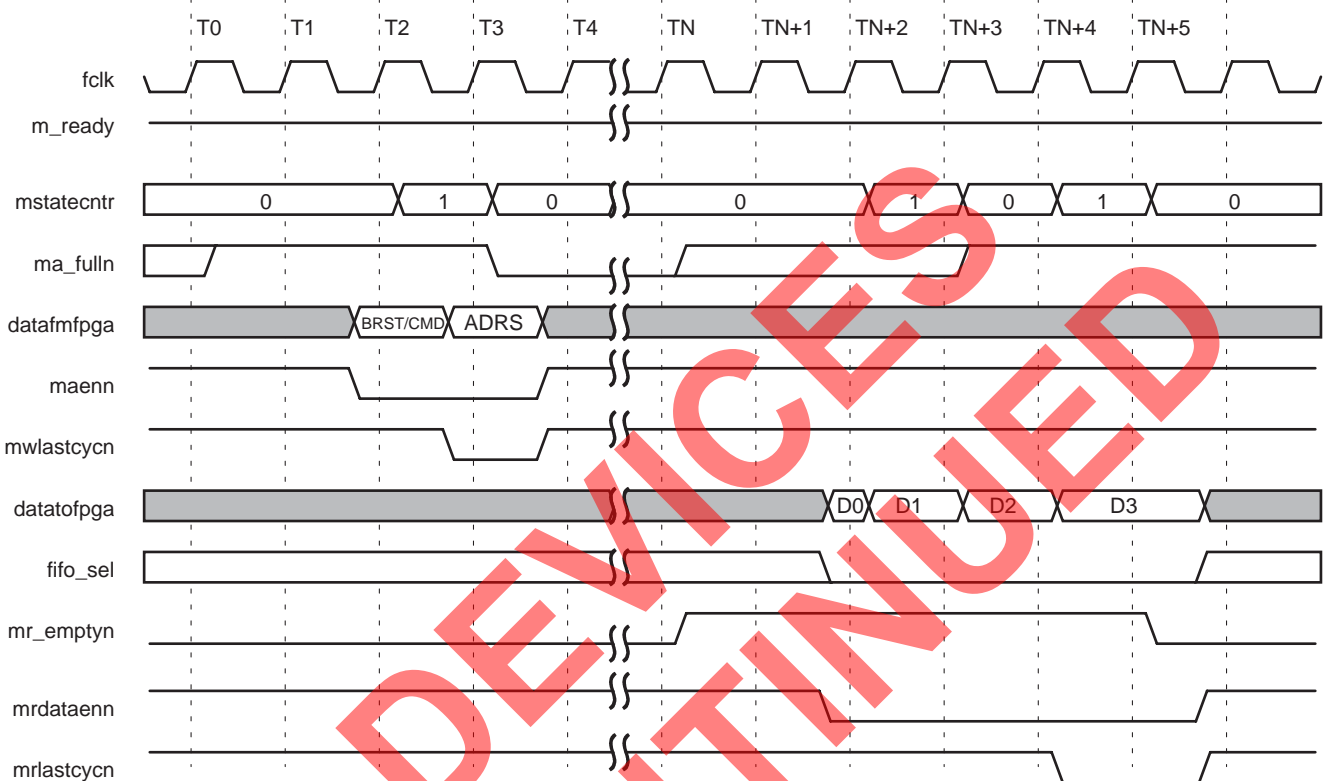

5-7353(F)

Figure 12. Master Read Burst (FIFO Interface, Dual-Port)

PCI Bus Core Master Controller Detailed Description (continued)

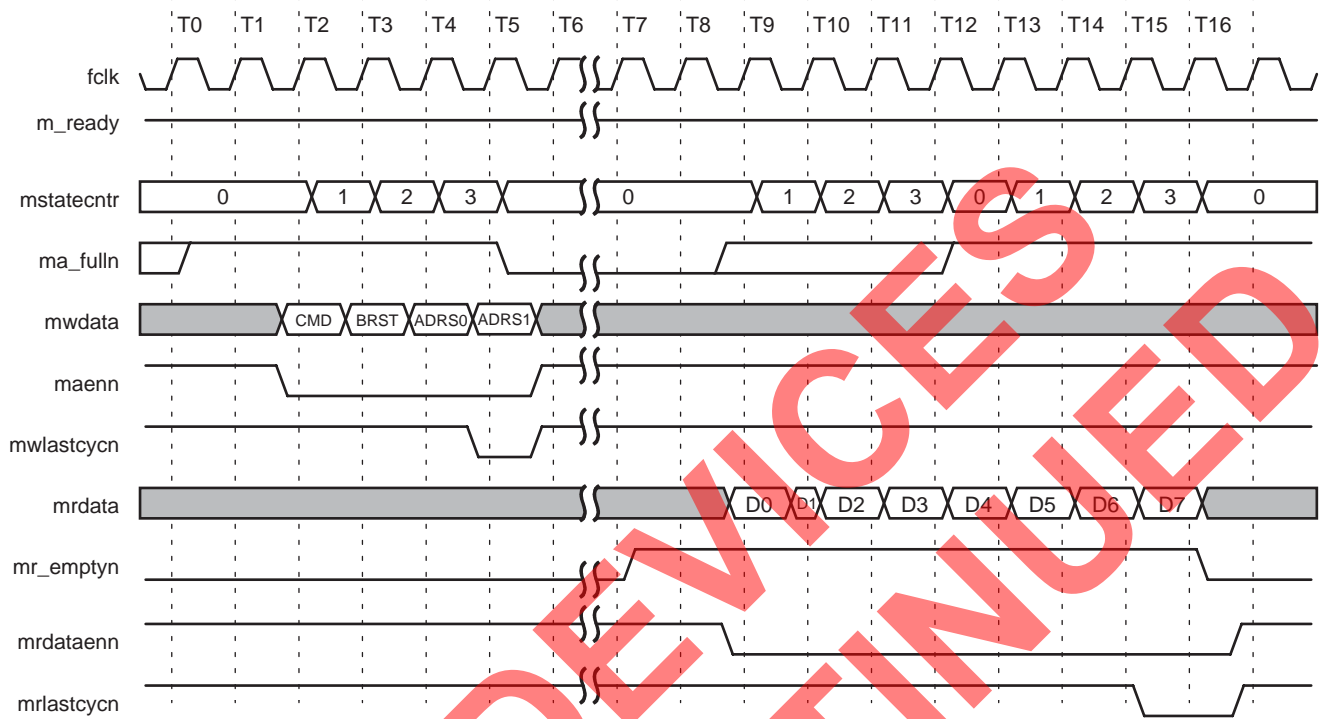

5-7361(F)

Figure 13. Master Read Burst (FIFO Interface, Quad-Port)

ALL DOCUMENTS DISCONTINUED

PCI Bus Core Master Controller Detailed Description (continued)

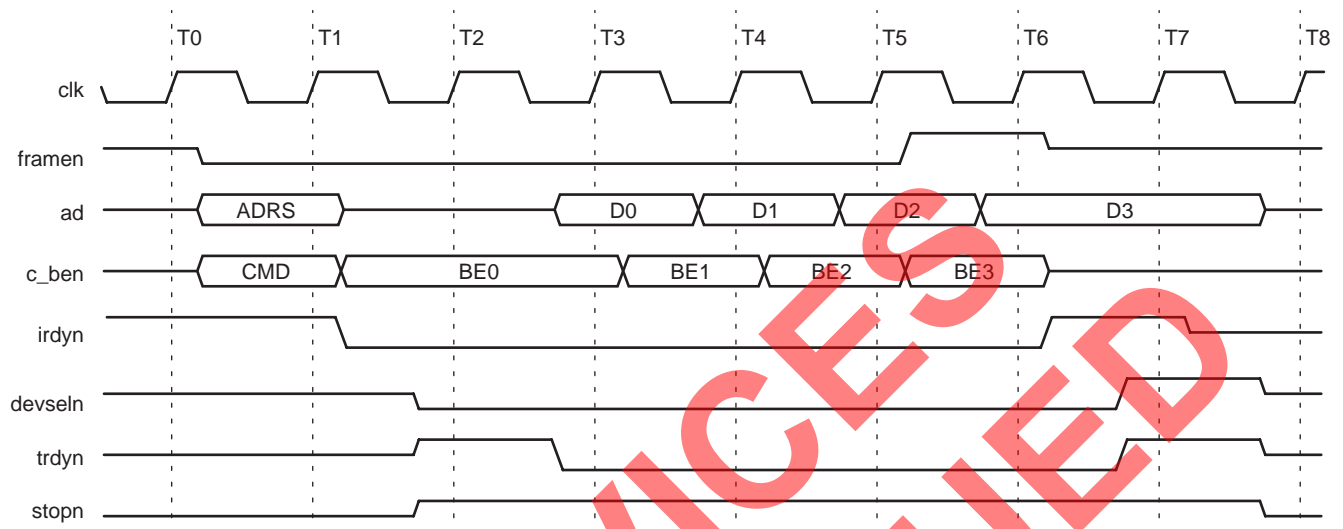

5-7369(F)

Figure 14. Master Read Burst (PCI Bus, 32-Bit)

Table 15. Dual-Port Master Read, Specified Burst Length

MStateCntr	Next State of MStateCntr	Description	Data on Bus datafmgax[3:0] datafmpga[31:0]	Data on Bus datatofpga[31:0]	Notes
0	0	Idle, or Data[15:0]	X4 XXXXXXXX16	PCIData[31:0]	1, 4, 5
0	1 or 0	Burst Length, Command Word, or Data[63:32]	Burst Length, Command Word	PCIData[63:32]	2, 3, 4, 5, 6
1	0 or 2	Address[31:0]	X4, PCIAddress[31:0]	—	2, 3, 6
2	0	Address[63:32]	X4, PCIAddress[63:32]	—	2, 3, 6

1. When **maenn**, **mrdataenn**, and **ma_fulln** are deasserted high, the Master interface is idle.
2. When **maenn** is asserted low, a command/address phase is in progress.
3. **maenn** must be asserted low for command/address data to transfer and state to change.
4. **maenn** must be deasserted high and **mrdataenn** must be asserted low to execute the data phase.
5. Next state = 0 if **mrlastcycn** is asserted low (end of Master read data phase).
6. Next state = 0 if **mwlastcycn** is asserted low (end of Master command/address phase).

PCI Bus Core Master Controller Detailed Description (continued)

Table 16. Quad-Port Master Read, Duplicate Burst Length

MStateCntr	Next State of MStateCntr	Description	Data on Bus mwdata[17:0]	Data on Bus mrdata[15:0]	Notes
0	0	Idle	XX2 XXXX16	—	1
0	1 or 0	Command Word or Data[15:0]	Command Word	PCIData[15:0]	2, 3, 4, 5, 6
1	2 or 0	Address[15:0] or Data[31:16]	XX2, PCIAddress[15:0]	PCIData[15:0]	2, 3, 4, 5, 6
2	3 or 0	Address[31:16] or Data[47:32]	XX2, PCIAddress[15:0]	PCIData[47:32]	2, 3, 4, 5, 6
3	4 or 0	Address[47:32] or Data[63:48]	XX2, PCIAddress[47:32]	PCIData[63:48]	2, 3, 4, 5, 6
4	0	Address[63:48]	XX2, PCIAddress[63:48]	—	2, 3, 6

1. When **maenn**, **mrdataenn**, and **ma_fulln** are deasserted high, the Master interface is idle.
2. When **maenn** is asserted low, a command/address phase is in progress.
3. **maenn** must be asserted low for command/address data to transfer and state to change.
4. **maenn** must be deasserted high and **mrdataenn** must be asserted low to execute the read data phase.
5. Next state = 0 if **mrlastcycn** is asserted low (end of Master read data phase).
6. Next state = 0 if **mwlastcycn** is asserted low (end of Master command/address phase).

Table 17. Quad-Port Master Read, Specified Burst Length

MStateCntr	Next State of MStateCntr	Description	Data on Bus mwdata[17:0]	Data on Bus mrdata[15:0]	Notes
0	0	Idle	XX2 XXXX16	—	1
0	1	Command Word or Data[15:0]	Command Word	PCIData[15:0]	2, 3, 4, 5, 6
1	2 or 0	Burst Length or Data[31:16]	Burst Length	PCIData[31:16]	2, 3, 4, 5, 6
2	3 or 0	Address[15:0] or Data[47:32]	XX2, PCIAddress[15:0]	PCIData[47:32]	2, 3, 4, 5, 6
3	4 or 0	Address[31:16] or Data[63:48]	XX2, PCIAddress[15:0]	PCIData[63:48]	2, 3, 4, 5, 6
4	5 or 0	Address[47:32] or Data[63:48]	XX2, PCIAddress[47:32]	—	2, 3, 6
5	0	Address[63:48]	XX2, PCIAddress[63:48]	—	2, 3, 6

1. When **maenn**, **mrdataenn**, and **ma_fulln** are deasserted high, the Master interface is idle.
2. When **maenn** is asserted low, a command/address phase is in progress.
3. **maenn** must be asserted low for command/address data to transfer and state to change.
4. **maenn** must be deasserted high and **mrdataenn** must be asserted low to execute the read data phase.
5. Next state = 0 if **mrlastcycn** is asserted low (end of Master read data phase).
6. Next state = 0 if **mwlastcycn** is asserted low (end of Master command/address phase).

PCI Bus Core Target Controller Detailed Description

Target FIFO Interface

Overview

The Target FIFO interface consists of two transfer phases: command/address followed by data. This sequence must be followed with the assertion of **twlastcycn** indicating the completion of each phase. The PCI address and command are always provided by the Target FIFO interface with the address transferred on the data paths for the specific mode. In any port mode, the command and address are transferred during the same cycle with the Target command transferred on a separate bus **tcmd**. The command/address phase is followed by data transfer. For Target writes, write data with byte enables will be provided from the Target, whereas for Target reads, the Target will receive its data from the FPGA application. All types of data are transferred on the data paths defined by the operational mode (dual- or quad-port).

Target State Counter

The Target FIFO interface provides a state counter, **tstatecntr[3:0]**, that informs the FPGA application of its current state (Table 19). This state counter determines what data is being provided to the FPGA application by the Target FIFO interface during the command/address or write data phases, or what is expected from the FPGA application during the read data phases. The state counter transitions from one state to another in a predetermined manner. Table 20 through Table 23 detail the sequencing of the **tstatecntr** and the data transferred for Target write and read transactions.

The value on bus **tstatecntr** can be used to minimize FPGA logic or verify proper operation. The data provided by the Target FIFO interface to the FPGA application is accompanied by a value on **tstatecntr[3:0]**. This value can be directly used by the FPGA application to determine the proper orientation of the Target command, address and/or write data. This eliminates the need for logic in the FPGA to duplicate a state counter. The data required from the FPGA application by the Target during the read data phase is also defined by the value on **tstatecntr**. However, the state counter value being sent to the FPGA is in the same cycle that the data is sent from the FPGA application. Here, the value provided by the Target FIFO interface can be used to determine the next state, since current since current data, phase, enables, and state transitions are known.

Target Address Compare and BAR Size

The Target FIFO interface provides the following two features to reduce overhead when transferring the PCI start Target address during the command/address phase. First, the Target FIFO interface detects the page size of the base address register (BAR) that decoded the current PCI address, and only transfers the address bytes necessary to cover the page size.

Second, the Target FIFO interface provides a holding register which is used to compare the address of the previous Target transaction to the current one. If there is a match, the most significant address information is not transferred, providing the BAR size is greater than the data bus size for quad- or dual-port mode. This will cover address bits [63:48] in quad-port and bits [63:32] in the dual-port mode. This option is enabled through the FPSC configuration manager of the FPSC design kit.

Target Write Operation

Delayed Transactions, Target Memory Write

Target memory write operations cannot be processed as delayed (delayed transactions: PCI Specification 2.2: Section 3.3.3.3), and are always posted. The Target will only retry a memory write transaction if a current Target transaction is in progress (**treqn** is asserted) or **t_retryn** is asserted. Once the Target determines that it is the intended recipient, it asserts **devseln** and **trdyn** and begins storing data into the Target write FIFO, providing space is available.

Delayed Transactions, Target I/O Write

Target I/O write operations can be posted (**deltrn** = 1) or delayed (**deltrn** = 0), and always disconnect burst accesses into single accesses. For a delayed I/O write, the Target records the PCI bus command, address, and first data word (32 or 64 bits) along with its byte enables (4 or 8 bits) during the initial access. The PCI bus command and address are put in the Target address FIFO, and the data word and byte enables are put in the Target write FIFO. On the PCI bus, the request is terminated in a retry (with the Master unaware that the data was snooped), and the FPGA application is informed that a Target request is pending via the assertion of **treqn**. The transaction status at this time is DWR (delayed write request—see PCI Specification 2.2: Section 3.3.3.3.6), and subsequent requests will be terminated in retry until the FPGA application processes the Target transaction.

PCI Bus Core Target Controller Detailed Description (continued)

When the FPGA application reads the Target write FIFO and empties it, the transaction status changes to DWC (delayed write completion), and the next Target I/O write that matches the stored command, address, data, and byte enables will be disconnected with data, completing the transaction and clearing the Target address and Target write FIFOs.

Target Configuration Writes

Accesses of configuration space occur without any involvement of the FPGA application. All configuration space accesses are disconnected with data on the first data word and are thus restricted from bursting.

Target Write Wait-States

All Target write data is accepted with zero wait-states. When a Target memory write operation fills the Target write FIFO, future response depends on signal **twburstpendn**. If it is deasserted, the Target will generate a disconnect without data on the next data cycle. If it is asserted, the Target will insert up to eight wait-states and then disconnect without data if the FIFO remains full. Target I/O operations cannot fill the FIFO because they do not burst, disconnecting with data on the first Dword.

Command/Address Setup

When the Target has accepted a PCI Target transaction, it will inform the FPGA application by asserting the signal **treqn**. The FPGA application can then transfer the PCI start address, Target command word, and data in the specific order prescribed in Table 20 through Table 23, for the operational mode (quad- and dual-

port). The address data is transferred via bus **twdata** (quad-port mode) or **datatofpga** (dual-port mode with **fifo_sel = 1**) when **taenn** is asserted. **taenn** should only be asserted when **treqn** is active and **t_ready** is active. The command/address phase ends with the assertion of **twlastcycn**. The Target command word (PCI bus command) and decoded BAR register are transferred on the separate buses, **tcmd** and **bar** respectively, and are valid when **treqn** is active.

The number of cycles necessary to send the Target address can vary. The Target FIFO interface will analyze the size of the decoded BAR and perform the minimal number of cycles to completely transfer the page of the address. For example, if the BAR is 256K in size, only the lower 18 bits of address is required by the FPGA application. This will result in one clock address transfer for dual-port (32-bits) and two for the quad-port (16-bits).

Accompanying the address data during the assertion of **taenn**, is information on the current Target transaction (Table 18). Dual-address or 64-bit address is indicated during the address phase by **twdata[16]** (quad-port) or **datatofpgax[0]** (dual-port with **fifo_sel = 1**) being asserted. If the current transaction is a burst, **twdata[17]** (quad-port) or **datatofpgax[1]** (dual-port with **fifo_sel = 1**) will be asserted.

All burst transactions (burst indication bit active) and 64-bit agents (**pci_64bit = 1**) will have the Target data aligned on a 64-bit address boundary (**ad2 = 0**), even if the PCI start address starts on a 32-bit address with **ad2 = 1**. If the burst transaction on the PCI bus starts on an odd 32-bit address boundary (**ad2 = 1**), the data phase start address will be on a 64-bit address boundary (**ad2 = 0**). Likewise, the data phase will also end on a 64-bit address boundary, therefore the number of transfers between the Target FIFO interface and the FPGA application will always be even for burst transactions and 64-bit agents (**PCI_64bit = 1**).

Table 18. Bit Destinations for Target Command/Address Phase

Bits	Name	Description	Quad-Port	Dual-Port
Target Address Word (PCI Core → FPGA)				
17	BI	Burst Indication	twdata[17]	datatofpgax[1]
16	DA	Dual-Address Indication	twdata[16]	datatofpgax[0]
15:0	Adrs	Address	twdata[15:0]	datatofpga[31:0]
Target Command Word (PCI Core → FPGA)				
3:0	Cmd	PCI Command Code*	tcmd[3:0]	tcmd[3:0]

* Refer to PCI Specification 2.2 Section 3.1.

PCI Bus Core Target Controller Detailed Description (continued)

For a write burst transaction to an odd address (**ad2** = 1), the first write data word transferred to the FPGA application will have all its byte enables deasserted and can be discarded. For Target read transactions to an odd address (**ad2** = 1), the first read data word provided by the FPGA application is discarded by the Target FIFO interface.

For single transaction (burst indication bit deasserted) on 32-bit PCI bus (**pci_64bit** = 0), the Target FIFO interface handles all data alignment. The received address is valid as transferred, with the data phase aligning to this address. No extra data is transferred or discarded.

Table 19. Target State Counter (TStateCntr) Values and the Corresponding Bus Data

TStateCntr[3:0]	Dual-Port Mode (32-bit Ports)		Quad-Port Mode (16-bit Ports)	
	Data on Bus datatofpga	Data on Bus datafmfpga	Data on Bus twdata	Data on Bus trdata
0	Adrs[31:0]	Data[31:0]	Adrs[15:0]	Data[15:0]
1	Adrs[63:32]	Data[63:32]	Adrs[31:16]	Data[31:16]
2	—	—	Adrs[47:32]	Data[47:32]
3	—	—	Adrs[63:48]	Data[63:48]
4	Data[31:0]	—	Data[15:0]	—
5	Data[63:32]	—	Data[31:16]	—
6	—	—	Data[47:32]	—
7	—	—	Data[63:48]	—
8	—	—	—	—
9	—	—	—	—
A	—	—	—	—
B	—	—	—	—
C	—	—	—	—
D	—	—	—	—
E	—	—	—	—
F	—	—	—	—

PCI Bus Core Target Controller Detailed Description (continued)

Write Data Transfer

The FPGA application enters the write data phase by deasserting **taenn** and asserting **twdataenn**. On every cycle that **twdataenn** is asserted, the FPGA application receives write data and its associated byte enables from the Target write data FIFO (64 32-bit words; 32 64-bit words) via bus **twdata** (quad-port mode) or **datatofpga** (dual-port mode with **fifo_sel** = 1), providing the write data FIFOs are not empty (**tw_emptyn** = 1). **twdataenn** must not be asserted when the write data FIFOs are empty (**tw_emptyn** is asserted). Note that **tw_emptyn** can be updated on the same clock edge as **twdataenn** is sampled.

The distinction between a burst write and a single access is provided by the burst indication bit (**twdata[17]** (quad-port); **datatofpgax[1]** (dual-port with **fifo_sel** = 1), or behavior of the **twlastcycn** signal during the data phase. When **twlastcycn** is asserted, this signal informs the FPGA application of the end of the write data phase. **twlastcycn** will remain deasserted with every write data element except the last element on bus **twdata** (quad-port mode) or **datatofpga** (dual-port mode with **fifo_sel** = 1). For example, on a single 32-bit word transfer in dual-port mode, **twlastcycn** would be asserted during the entire write data phase, since the last data phase is the only data phase of this transfer.

When executing on a 64-bit PCI bus (**pci_64bit** = 1) or a burst Target write, the write data transferred from the FPGA application is aligned on 64-bit address boundaries. This alignment may transfer extra padding data from the FIFOs for activity during 32-bit PCI transfers. For transfers starting at an odd 32-bit PCI address (**ad2** = 1), the FPGA application will receive a 32-bit padding data word at the beginning of the write data phase. For burst transfers starting at an even PCI address (**ad2** = 0) with an odd number of 32-bit data words, a 32-bit padding data word will be received at the end of the data phase. Padding data words are indicated by data words with all of its byte enables deasserted.

For single 32-bit transactions (Burst indication bit deasserted) on 32-bit PCI buses (**pci_64bit** = 0), the Target FIFO interface will perform proper data alignment. During the data phase, the FPGA application will only receive the 32-bit data word, and no padding words are present.

Target Write Data FIFO Empty/Almost Empty

When the Target write FIFO contains four or fewer 64-bit data elements, the Target FIFO interface asserts **tw_aemptyn** the FIFO almost empty indicator. This allows some latency to exist in the FPGA's response without risking overreading the FIFO. When the FPGA application has read all data out of the Target write FIFO, the Target FIFO interface asserts **tw_emptyn**, the FIFO empty indicator. Since data can be simultaneously written to, and read from, the Target write FIFO, both **tw_aemptyn** and **tw_emptyn** can change states in either direction multiple times in the course of a burst data transfer.

Target Write Termination

Target write termination will be by normal Master termination, disconnect associated with a full Target write data FIFO, retry associated with a pending Target transaction, or a reset by **rstn**.

On the Target FIFO interface, **twlastcycn** signals when the last item remaining in the Target write FIFO has been received by the FPGA application (although the actual PCI bus transaction may have completed much earlier). The Target FIFO interface then signals end of transaction to the FPGA application by deasserting **treqn** for at least one clock. If **treqn** subsequently reasserts, this indicates a new, unrelated transaction.

Reset

The FPGA application can apply a reset signal to place the Target FIFO interface logic in a known state, clearing the Target FIFOs and resetting **tstatecntr**. The reset signal, **tfifoclrn**, is asynchronous and therefore should be asserted for a minimum of one clock cycle and deasserted for a minimum of one clock cycle before continuing.

It is not recommended to assert **tfifoclrn** while a current PCI transaction is in progress (**treqn** is asserted), since proper PCI bus termination is not guaranteed. Only **rstn** will reset the internal Target PCI state machines, while a PCI transaction is in progress.

PCI Bus Core Target Controller Detailed Description (continued)

Example: Target Write to Configuration Space Transaction

Figure 15 shows the timing on the PCI interface for a Target write to configuration space. Configuration space accesses occur without any involvement of the FPGA interface. All configuration space accesses are disconnected with data on the first data word and are thus restricted from bursting. Address decode speed is medium, and the Target signals that it is ready to receive the word of data by asserting **trdyn** one cycle after **devseln** is asserted.

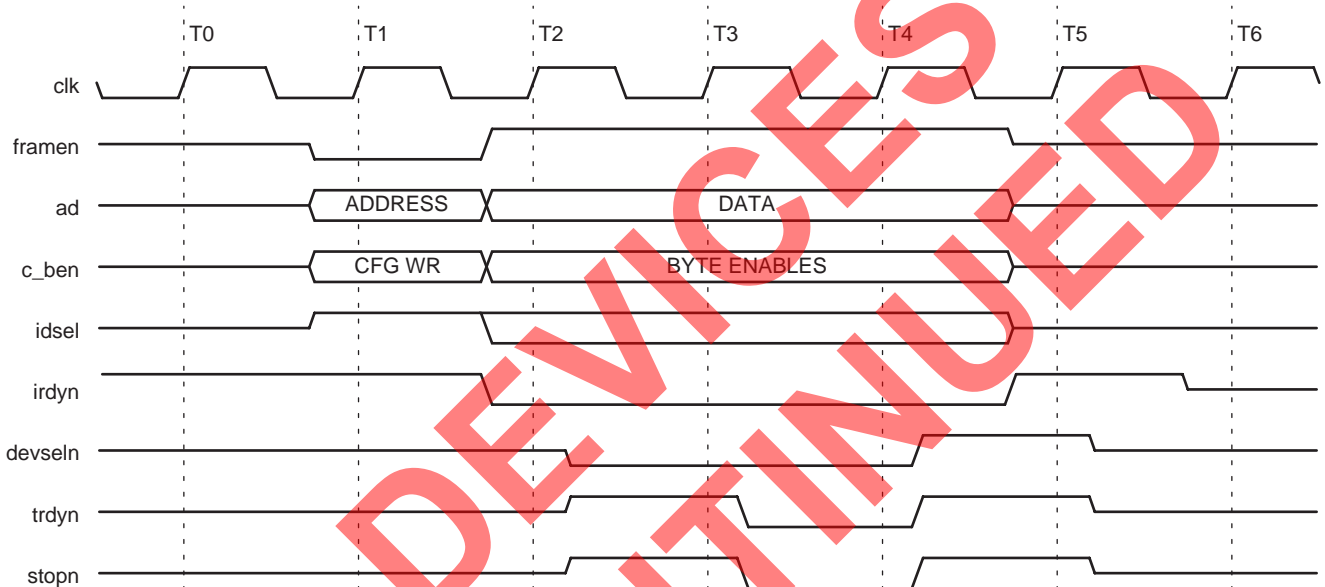

5-7370(F)

Figure 15. Target Configuration Write (PCI Bus, 32-Bit)

PCI Bus Core Target Controller Detailed Description (continued)

Example: Target Write I/O

Figure 16 shows the timing on the PCI bus for a Target I/O write which is posted; that is, the operation completes on the PCI bus immediately. The Target terminates the I/O write request by disconnecting with data on the first word, thus disallowing bursting.

For a delayed Target I/O write, the initial access would terminate with a retry although the Target transaction has been snooped and forwarded on to the FPGA application. Retry terminations will continue on all future accesses until the FPGA application has finished processing the Target I/O write transaction. On the next access of this Target I/O write, the Target terminates the I/O write request by disconnecting with data on the first word, also disallowing bursting.

The FPGA interface timing is as shown in Figure 18 and Figure 19 for dual- and quad-port respectively. The FPGA interface timing is similar for Target I/O writes and Target single memory writes, and is described below in the Single Target Write FIFO Interface section.

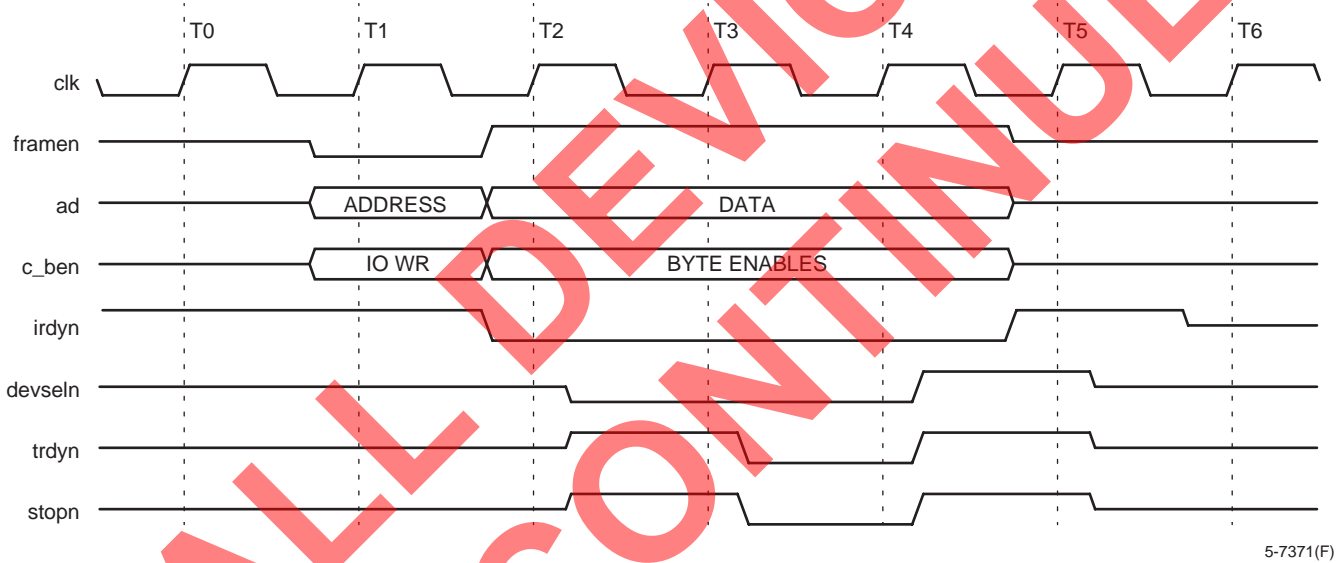

Figure 16. Target I/O Write, Nondelayed (PCI Bus, 32-Bit)

PCI Bus Core Target Controller Detailed Description (continued)

Target Write Memory, Single-Word Transaction

Figure 17 shows the timing on the PCI bus, for a Target memory write of a single word. The timing on the PCI interface (Figure 17) is similar to that of a posted I/O write (Figure 16) except that, since bursts to memory space are allowed, the signal **stopn** is not asserted.

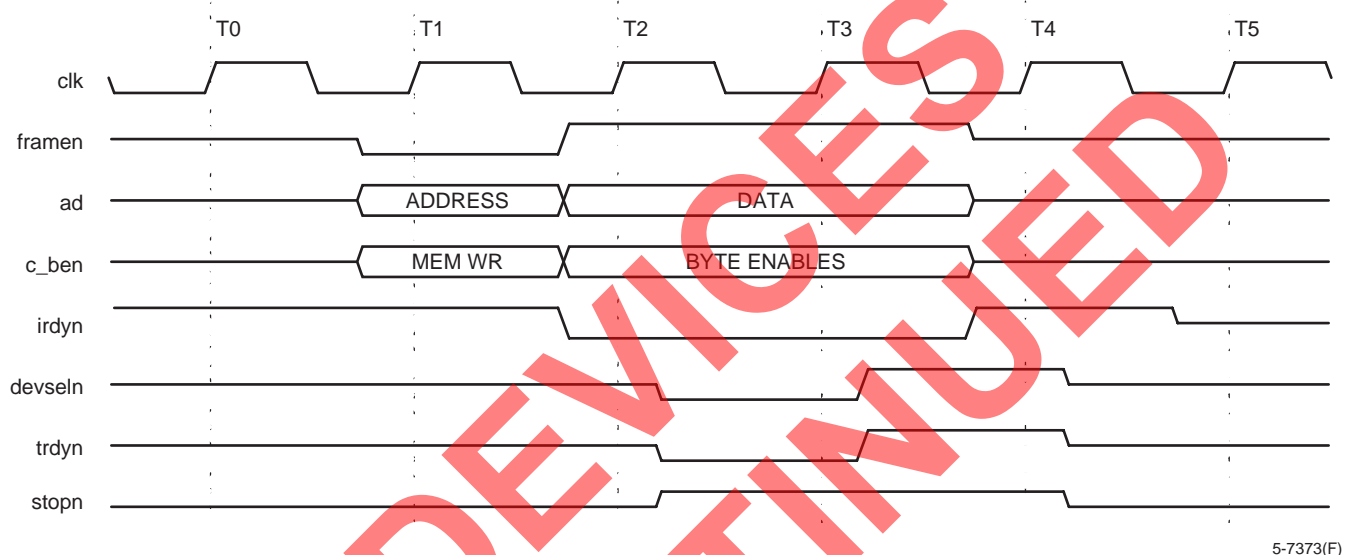

Figure 17. Target Memory Single Write (PCI Bus, 32-Bit)

Single Target Write FIFO Interface

The FIFO interface timing is as shown in Figure 18 and Figure 19 for dual- and quad-port respectively. The interface timing is similar for all Target I/O writes and Target single memory writes, since the Target FIFO interface is uniform across all Target accesses.

The timing on the interface (Figure 18 for dual-port) shows the first indication to the FPGA application that a new operation is pending by the assertion of Target request (**treqn**). When **treqn** is valid, the FPGA application begins the command/address phase by asserting Target address enable (**taenn**) and accepting the command from bus **tcmd** and address from bus **datatofpga(x)** (with **fifo_sel** = 1). If applicable, the dual-address indication bit accompanies the address on **datatofpga[0]**, whereas for the single access on a 32-bit PCI bus (**pci_64bit** = 0) the burst indication bit (**datatofpga[1]**) will be deasserted. The FPGA application continues to receive new address data (**taenn** asserted) on every clock until **twlastcycn** is asserted, indicating the end of the command/address phase. See command/address section for notes regarding address transfer and alignment.

The write data phase will follow, by deassertion of **taenn**, and assertion of Target write data enable (**twdataenn**). **twdataenn** can only be asserted while **tw_emptyn** is deasserted, indicating that write data is available in the write data FIFOs. While **twdataenn** is asserted, the FPGA application will receive Target write data on bus **datatofpga** (with **fifo_sel** = 1). The FPGA application is informed that the last component of the data phase is being presented when **twlastcycn** is asserted. Since this is a single access on a 32-bit data bus (assuming **datatofpgax[1]** = 0 during command/address phase, **pci_64bit** = 0), the first and only data phase is the last data of the write data phase.

PCI Bus Core Target Controller Detailed Description (continued)

For quad-port mode (Figure 19), the address and write data are transferred on the bus **twdata** in 16-bit segments. The address will be split into two 16-bit components with the LSB being transferred first. If applicable, the dual-address indication accompanies the address on **twdata[16]**, whereas for a single access on a 32-bit PCI bus (**pci_64bit = 0**) the burst indication bit (**twdata[17]**) will be deasserted. Assuming a BAR size greater than 16 bits, the address phase will require two clock cycles, and **twlastcycn** will be asserted on the final or MSB component of the address.

The data phase will also require two clock cycles to transfer a single 32-bit write data word across the 16-bit bus. **twdataenn** can only be asserted while **tw_emptyn** is deasserted, indicating that write data is available in the write data FIFOs. While **twdataenn** is asserted, the FPGA application will receive Target write data on bus **twdata**. **twlastcycn** will be deasserted for all 16-bit components of the write data phase, except for the final 16-bit component, where it is asserted.

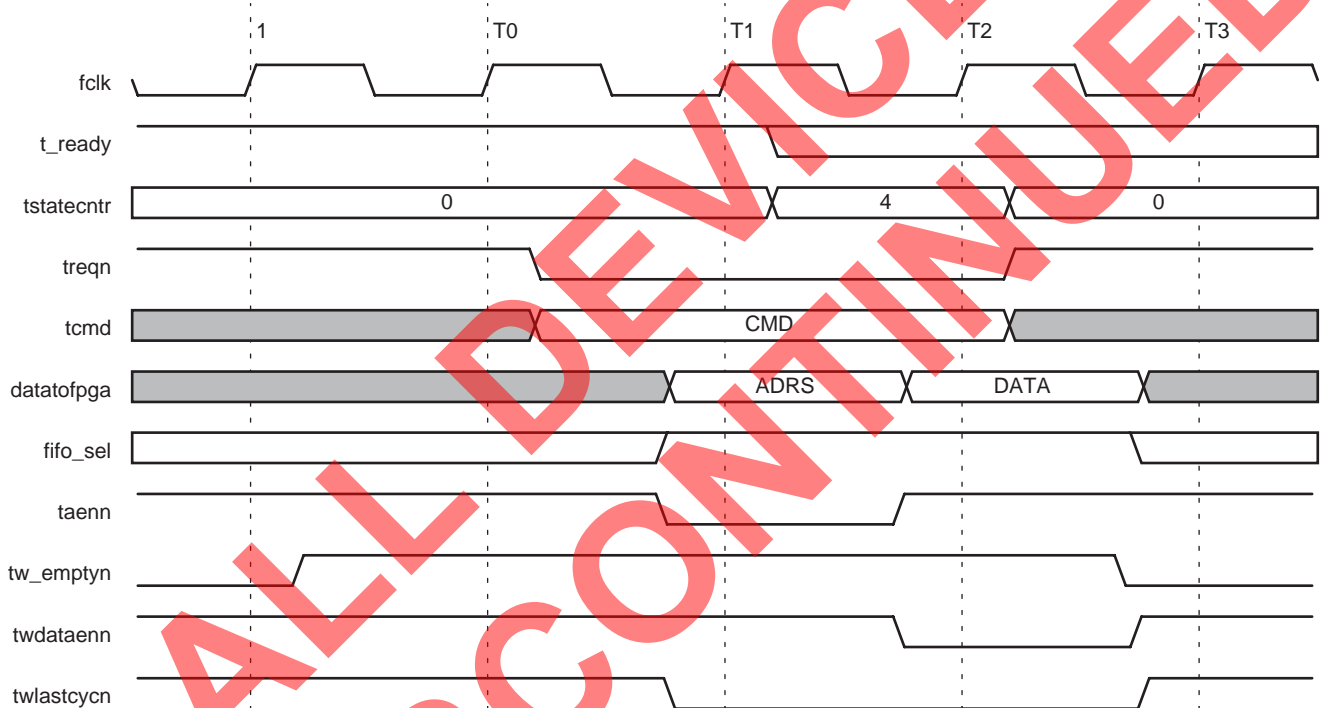

5-7354(F)

Figure 18. Target Write Single (FIFO Interface, Dual-Port)

PCI Bus Core Target Controller Detailed Description (continued)

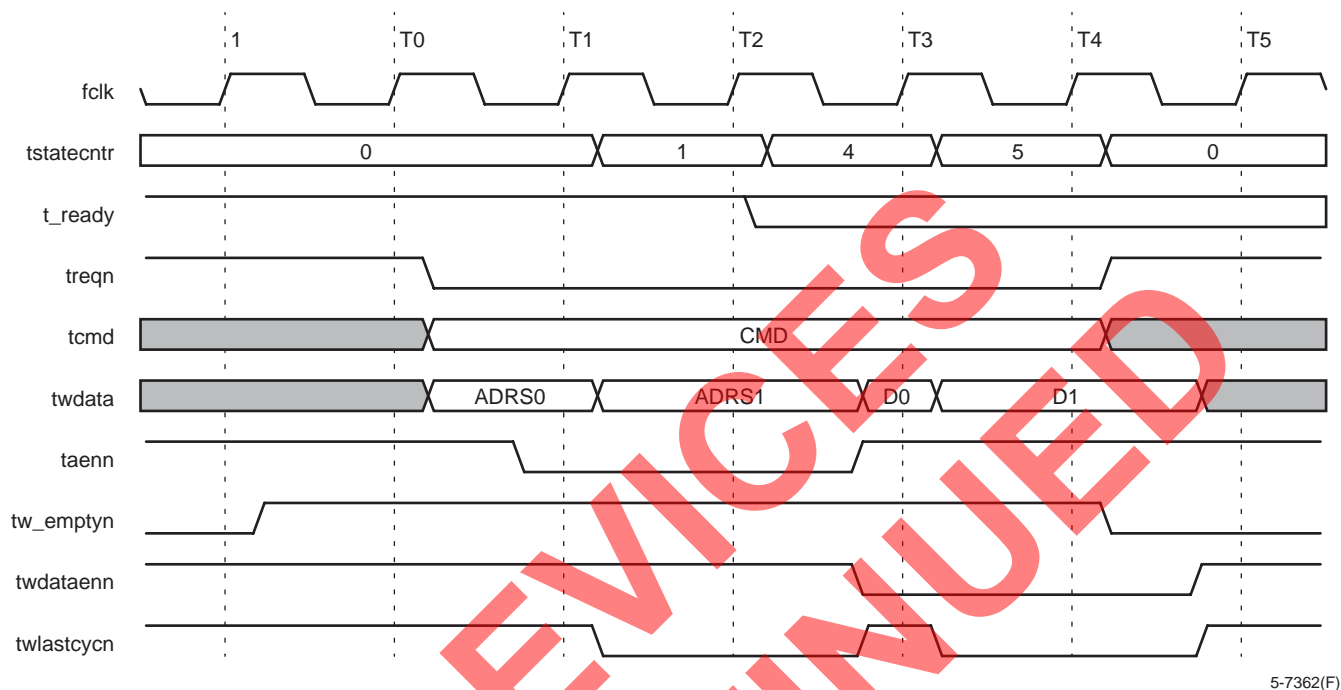

Figure 19. Target Write Single (FIFO Interface, Quad-Port)

Example: Target Write Memory Burst Transaction

Figure 20 shows the timing on the PCI bus for a Target memory write burst of four 32-bit words. The timing on the PCI interface is typical for a medium-speed decode Target. Note that **trdyn** is asserted at the earliest possible time, which is concurrent with assertion of **devseln**. In the example of a 4-word burst, the Target write FIFO is not filled, so execution continues to completion. This would also be the case for a burst of any length when the FPGA application is capable of unloading the FIFO as fast as the PCI interface is loading it. If the Target write FIFO becomes full, the Target can disconnect without data on the first data word it cannot accept (**twburstpendn** = 1), or insert up to eight wait-states (**twburstpendn** = 0).

The timing on the dual-port FIFO interface (Figure 21) shows the first indication to the FPGA application that a new operation has begun by the assertion of Target request (**treqn**). When **treqn** is valid, the FPGA application begins the command/address phase by asserting Target address enable (**taenn**) and accepting the command from bus **tcmd** and address from bus **datatofpga(x)** (with **fifo_sel** = 1). A burst operation and dual-address indication accompanies the address on **datatofpgax[1]** and **datatofpgax[0]** respectively. The FPGA application continues to receive new address data (**taenn** asserted) on every clock until **twlastcycn** is asserted, indicating the end of the command/address phase. See command/address section for notes regarding address transfer and alignment.

PCI Bus Core Target Controller Detailed Description (continued)

The write data phase will follow, by deassertion of **taenn**, and assertion of Target write data enable (**twdataenn**). **twdataenn** can only be asserted while **tw_emptyn** is deasserted, indicating that write data is available in the write data FIFOs. While **twdataenn** is asserted, the FPGA application will receive Target write data on bus **datatofpga** (with **fifo_sel** = 1), and write byte enables on **datatofpgax**. The FPGA application is informed that the last component of the data phase is being presented when **twlastcycn** is asserted. Since this is a burst access (**datatofpgax[1]** = 1 during command/address phase), the **twlastcycn** is deasserted for the entire data phase except the last data of the write data phase. After receiving **twlastcycn** at the end of the data phase, **twdataenn** must be deasserted by the FPGA application. See Write Data Transfer section for notes regarding data alignment on bursts.

For quad-port mode (Figure 22), the address and write data is transferred on the bus **twdata** in 16-bit segments. If necessary, the address will be split into two 16-bit components with the LSB being transferred first. A burst operation and dual-address indication accompanies the address on **twdata[17]** and **twdata[16]** respectively. Assuming the BAR size is greater than 16 bits, the address phase will require two clock cycles, and **twlastcycn** will be asserted on the final or MSB component of the address. The data phase will also require two clock cycles to transfer every 32-bit write data word across the 16-bit bus. **twlastcycn** will be deasserted for all 16-bit components of the write data phase, except for the final 16-bit component where it is asserted. See Write Data Transfer section for notes regarding write data alignment.

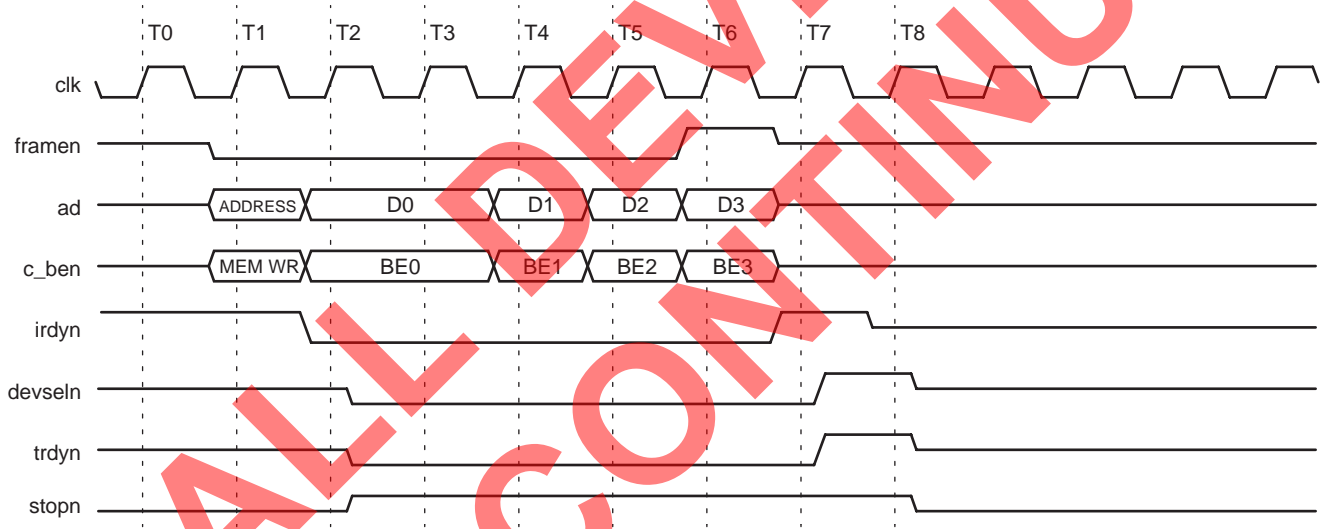

5-7374(F)

Figure 20. Target Memory Write Burst (PCI Bus, 32-Bit)

PCI Bus Core Target Controller Detailed Description (continued)

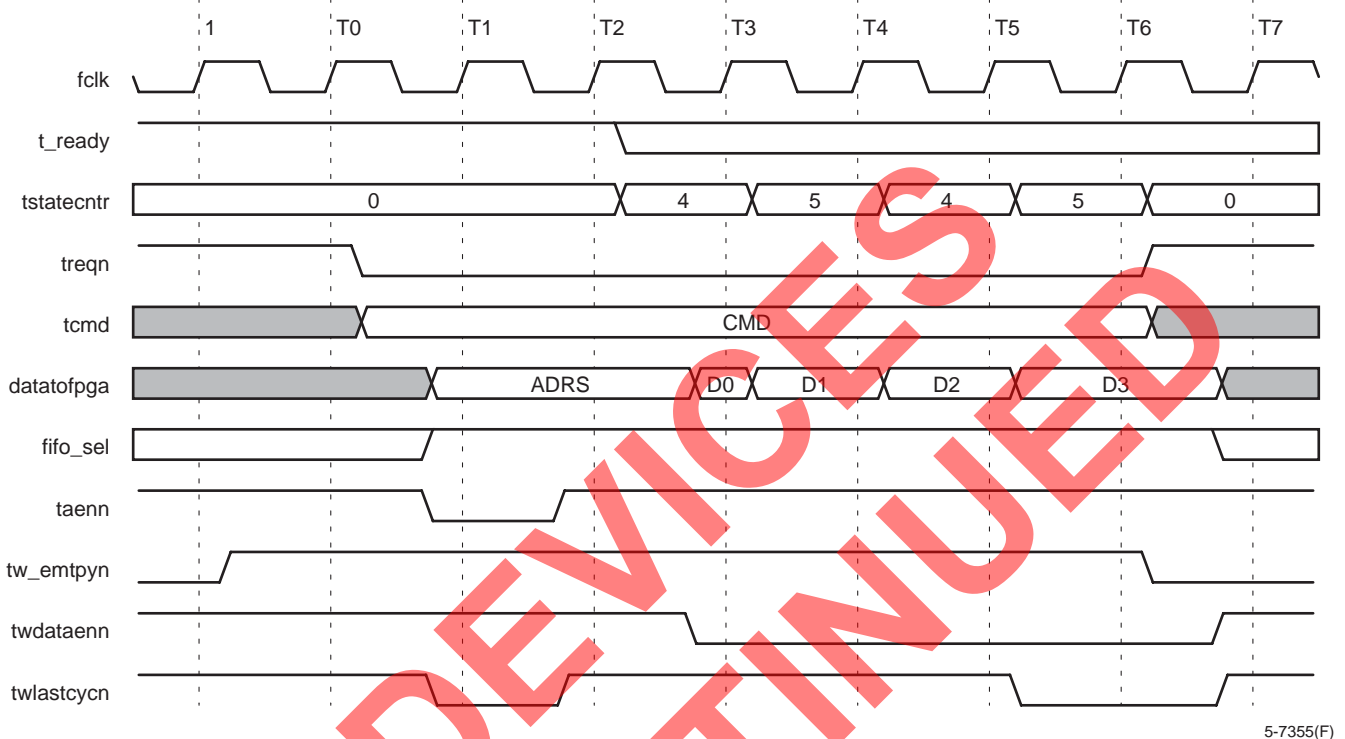

Figure 21. Target Write Burst (FIFO Interface, Dual-Port)

ALL DEVICES DISCONTINUED

PCI Bus Core Target Controller Detailed Description (continued)

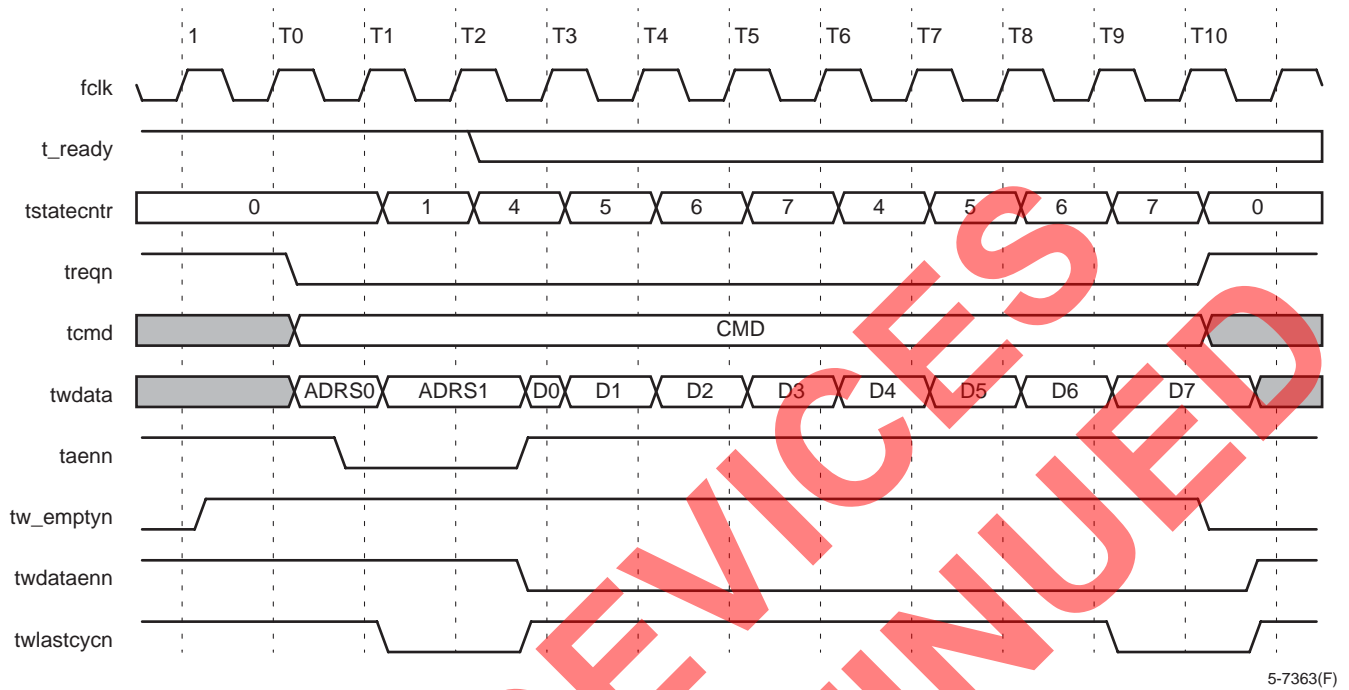

Figure 22. Target Write Burst (FIFO Interface, Quad-Port)

Table 20. Dual-Port Target Write

tstatecnr	Next State or tstatecnr	Description	Data on Bus datafmfpgax[3:0], datafmfpga[31:0]	Notes
0	0	Idle	X4, XXXXXXXX16	1
0	1 or 4	Address[31:0]	X2, Burst, Dual-Address, PCIAddress[31:0]	2, 3, 6
1	4	Address[63:32]	X2, Burst, Dual-Address, PCIAddress[63:32]	2, 3, 6
4	5 or 0	Data[31:0]	BEN[3:0], PCIData[31:0]	4, 5
5	4 or 0	Data[63:32]	BEN[7:4], PCIData[63:32]	4, 5

1. When **treqn** is deasserted high, the Target interface is idle.
2. When **taenn** is asserted low, a command/address phase is in progress.
3. **taenn** must be asserted low for command/address data to transfer and state to change.
4. **taenn** must be deasserted high and **twdataenn** must be asserted low to execute the data phase.
5. Next state = 0 if **twlastcycn** is asserted low (end of Target write data).
6. Next state = 4 if **twlastcycn** is asserted low (end of Target command/address phase).

PCI Bus Core Target Controller Detailed Description (continued)

Table 21. Quad-Port Target Write

tstatecncr	Next State or tstatecncr	Description	Data on Bus twdata[17:0]	Notes
0	0	Idle	XX2, XXXX16	1
0	1 or 4	Address[15:0]	Burst, Dual-Address, PCIAddress[15:0]	2, 3, 6
1	2 or 4	Address[31:16]	Burst, Dual-Address, PCIAddress[31:16]	2, 3, 6
2	3 or 4	Address[47:32]	Burst, Dual-Address, PCIAddress[47:32]	2, 3, 6
3	4	Address[63:48]	Burst, Dual-Address, PCIAddress[63:48]	2, 3, 6
4	5	Data[15:0]	BEN[1:0], PCIData[15:0]	4
5	6 or 0	Data[31:16]	BEN[3:2], PCIData[31:16]	4, 5
6	7	Data[47:32]	BEN[5:4], PCIData[47:32]	4
7	4 or 0	Data[63:48]	BEN[7:6], PCIData[63:48]	4, 5

1. When **treqn** is deasserted high, the Target interface is idle.
2. When **taenn** is asserted low, a command/address phase is in progress.
3. **taenn** must be asserted low for command/address data to transfer and state to change.
4. **taenn** must be deasserted high and **twdataenn** must be asserted low to execute the data phase.
5. Next state = 0 if **twlastcycn** is asserted low (end of Target write data).
6. Next state = 4 if **twlastcycn** is asserted low (end of Target command/address phase).

Target Read Operation

A Target read operation presents unique demands on the FPGA application because only in this operation does the Target request data that is needed to complete the transaction after the PCI transaction has already begun on the PCI bus. Target latency rules require that the data be acquired quickly or that the Target terminate the transaction with a retry/disconnect. Also, once the transfer process is underway, the Target usually does not know how much more data will be requested. The Target must prefetch data so that it will be available if needed.

Delayed Transactions

A signal (**deltrn**) from the FPGA application influences the behavior of Target read and I/O write operations. When **deltrn** is asserted-low, the Target controller logic will enter delayed mode on incoming Target reads (memory or I/O) and I/O writes. Delayed mode will issue a retry to the external Master, but store internally the PCI address, command, and write data (if an I/O write). The retry frees up the PCI bus for other activity, while the FPGA application processes the Target request. When the external Master attempts the same transaction again to the Target, read data will be transferred if the Target read FIFOs are nonempty. When this signal is inactive-high, the Target controller will generate wait-states, until either the FIFO becomes not empty and transmits the read data, or until the maximum initial latency value (16 or 32 clock cycles in the FPSC configuration manager) has been reached. If **deltrn** is deasserted, **twburstpendn** must be asserted.

This signal should be inactive when minimum initial latency is desired on the initial data word, at the expense of overall PCI bus efficiency. Signal **deltrn** affects the transaction's behavior on the initial data word, whereas signal **trburstpendn** affects subsequent data latency when the Target read data FIFO empties. When **trburstpendn** is inactive, a disconnect without data results from an attempt to read from an empty read data FIFO, after data has been transferring on the PCI bus. With **trburstpendn** active, the Target will wait for data from the FIFO by inserting wait-states (up to the maximum subsequent latency value of eight, at which time a disconnect without data will be generated). Asserting **trburstpendn** will minimize latency for this transaction's data at the expense of overall PCI bus efficiency. **trburstpendn** must remain static throughout a Target read transaction.

PCI Bus Core Target Controller Detailed Description (continued)

Although, the signal **deltrn** is used to enter into delayed mode, all Target read transactions automatically enter delayed mode on a retry. For example, if the Target inserted 16/32 wait-states on the initial read access and no data was provided to the Target read data FIFO causing a disconnect, the transaction will revert into delayed mode. On the following external Master accesses, if no data was available in the Target read data FIFO, an immediate retry would be issued with no wait-states.

I/O Reads

I/O reads differ only from memory reads in that I/O reads always perform a disconnect with data on the first data element read from the Target read FIFO.

Command/Address Setup

When the Target has accepted a PCI Target transaction, it will inform the FPGA application by asserting the signal **treqn**. The FPGA can then transfer the PCI start address, Target command word, and data in the specific order prescribed in Table 22 through Table 23, for the operational mode (quad- and dual-port). The address data is transferred via bus **twdata** (quad-port mode) or **datatofpga** (dual-port mode with **fifo_sel** = 1) when **taenn** is asserted. **taenn** should only be asserted when **treqn** is active and **t_ready** is active. The command/address phase ends with the assertion of **trlastcycn**. The Target command word (PCI bus command) and decoded BAR register are transferred on the separate buses **tcmd** and **bar**, respectively, and are valid when **treqn** is active.

The number of cycles necessary to send the Target address can vary. The Target FIFO interface will analyze the size of the decoded BAR, and performed the minimal number of cycles to completely transfer the page of the address. For example, if the BAR is 256K in size, only the lower 18 bits of address is required by the FPGA application. This will result in one clock address transfer for dual-port (32-bits) and two for the quad-port (16-bits).

Accompanying the address data during the assertion of **taen**, is information on the current Target transaction. Dual-address or 64-bit address is indicated during the address phase by **twdata[16]** (quad-port) or **datatofpgax[0]** (dual-port with **fifo_sel** = 1) being asserted. If the current transaction is a burst, **twdata[17]** (quad-port) or **datatofpgax[1]** (dual-port with **fifo_sel** = 1) will be asserted.

All burst transactions (burst indication bit active) and 64-bit agents (**pci_64bit** = 1) will have the Target data aligned on a 64-bit address boundary (**ad2** = 0), even if the PCI start address starts on a 32-bit address with **ad2** = 1. If the burst transaction on the PCI bus starts on a odd 32-bit address boundary (**ad2** = 1), the data phase start address will be on a 64-bit address boundary (**ad2** = 0). Likewise, the data phase will also end on a 64-bit address boundary, therefore the number of transfers between the Target FIFO interface and the FPGA application will always be even. For Target read transactions starting at an odd 32-bit address boundary, the first read data word is ignored by the Target controller, but needs to be transferred by the FPGA application.

For single transactions (burst indication bit deasserted) on a 32-bit bus (**pci_64bit** = 0), the Target FIFO interface will handle all data alignment. The received address is valid, with the data phase aligning to the address. No extra data is transferred or padded.

Read Data Transfer

The FPGA application enters the read data phase by deasserting **taenn** and asserting **trdataenn**. On every cycle that **trdataenn** is asserted, the FPGA application provides read data to the Target read FIFO (64-, 32-bit words; 32-, 64-bit words) via bus **trdata** (quad-port mode) or **datafmfpga** (dual-port mode). **trdataenn** must not be asserted when the read data FIFOs are full (**tr_fulln** is asserted). All byte lanes are passed on to the PCI bus, therefore no byte enables are required. Note that **tr_fulln** can be updated on the same clock edge as **trdataenn** is sampled.

The distinction between a burst read and a single access on a 32-bit bus (**pci_64bit** = 0) is provided by the burst indication bit, **twdata[17]** (quad-port) or **datatofpgax[1]** (dual-port with **fifo_sel** = 1), along with the behavior of the **trlastcycn** signal during the data phase. When **trlastcycn** is asserted, this signal informs the FPGA application of the end of the read data phase, and that the Master has disconnected. **trlastcycn** will remain deasserted with every read data element except the last element on bus **trdata** (quad-port mode) or **datafmfpga** (dual-port mode). **trlastcycn** can remain asserted throughout a single (non-burst) Target read data phase. on a 32-bit PCI bus (**pci_64bit** = 0). For example, on a single 32-bit word transfer in dual-port mode, **trlastcycn** would be asserted during the entire read data phase, since the last data phase is the only data phase of this transfer. After receiving an asserted **trlastcycn**, the FPGA application should deassert **trdataenn**. For **trlastcycn** to be asserted, **trdataenn** must be asserted.

PCI Bus Core Target Controller Detailed Description (continued)

When executing a burst Target read, or on a 64-bit bus (**pci_64bit** = 1), the read data transferred from the FPGA application must be aligned on 64-bit address boundaries, which may require transferring extra padding data to properly fill the FIFOs for activity on 32-bit PCI buses. For transfers starting at an odd 32-bit PCI address (**ad2** = 1), the FPGA application will transfer an extra 32-bit padding data word at the beginning of the read data phase. For burst transfers starting at an even PCI address (**ad2** = 0) with an odd number of 32-bit data words, an extra 32-bit padding data word will be transferred at the end of the data phase. Padding data word can be any data words.

For single 32-bit transactions (burst indication bit deasserted) on a 32-bit PCI bus (**pci_64bit** = 0), the Target FIFO interface handles all data alignment. The received address is valid with the data phase aligning to the address. No extra padding of data is necessary.

At some times, the FPGA application may not have valid data to transfer to the Target read FIFO or the read data FIFOs may be filled, therefore **trdataenn** will be deasserted. If the external Master disconnects during this time, **trlastcycn** will not be produced. In this situation, the FPGA application must monitor the signal **t_ready** for an indication that the external Master is terminating the Target transaction. When **t_ready** is deasserted, the FPGA application will need to assert **trdataenn** to receive **trlastcycn** and properly reset the Target FIFO interface. During the time that **t_ready** is deasserted, the Target is clearing the Target read FIFOs and no data will be transferring to the PCI bus. Any read data transferred will be ignored during this time.

Burst transfers are performed as continuous data phases if read data is available in the Target read data FIFO. At completion of Target read bursts, there may result a discarding of unused data elements supplied in excess of the external Master transaction's needs. All data within the Target read FIFOs is cleared after Master termination.

Target Read FIFO Hold

The signal **trpchihold** can be asserted to delay the start of transfer of data during a Target read operation, i.e., **trdyn** asserted. While **trpchihold** is active, read data can be transferred from the FPGA application into the Target read FIFOs. When the Target read FIFOs become full or **trpchihold** is deasserted, the Target read operation will begin on the PCI bus. Use of this signal

can result in more efficient utilization of PCI bus bandwidth by causing up to a full buffer contents to be bursted, without wait-states, whenever the external Master accesses the Target.

FIFO Full/Almost Full

When the Target read FIFO contains four or fewer 64-bit empty locations, the Target FIFO interface asserts **tr_afulln**, the almost full indicator. This allows some latency to exist in the FPGA's response without risking overfilling the FIFO. When all locations in the Target read FIFO are full, the Target asserts **tr_fulln**, the full indicator. Since the data can be simultaneously written to and read from the Target read data FIFO, both **tr_afulln** and **tr_fulln** can change states in either direction multiple times in the course of a burst data transfer.

Termination

Target read termination will be by normal Master termination, disconnect associated with an empty Target read data FIFO, retry associated with a pending Target transaction, or a reset by **rstn**.

On the Target FIFO interface, **trlastcycn** signals when the external Master has gathered all of the necessary data from the Target read FIFO, even if extra data remains in the Target read FIFO. The Target FIFO interface signals end of transaction to the FPGA application by deasserting **treqn** for at least one clock. If **treqn** subsequently reasserts, this indicates a new, unrelated transaction.

Reset

The FPGA application can apply a reset signal to place the Target FIFO interface logic in a known state, clearing the Target FIFOs and resetting **tstatecntr**. The reset signal, **tfifoclrn**, is asynchronous and therefore should be asserted for a minimum of one clock cycle and deasserted for a minimum of one clock cycle before continuing.

It is not recommended to assert **tfifoclrn** while a current PCI transaction is in progress (**treqn** is asserted), since proper PCI bus termination is not guaranteed. Only **rstn** will reset the internal Target PCI state machines, while a PCI transaction is in progress.

PCI Bus Core Target Controller Detailed Description (continued)

Example: Target Read from Configuration Space

Figure 23 shows the timing on the PCI interface for a Target read from configuration space. Accesses of configuration space occurs without any involvement of the FPGA interface. All configuration space accesses are disconnected with data on the first data word, and are thus restricted from bursting. Address decode speed is medium, and the PCI bus core signals that it is supplying the word of data by asserting **trdyn** one cycle after **devseln** is asserted.

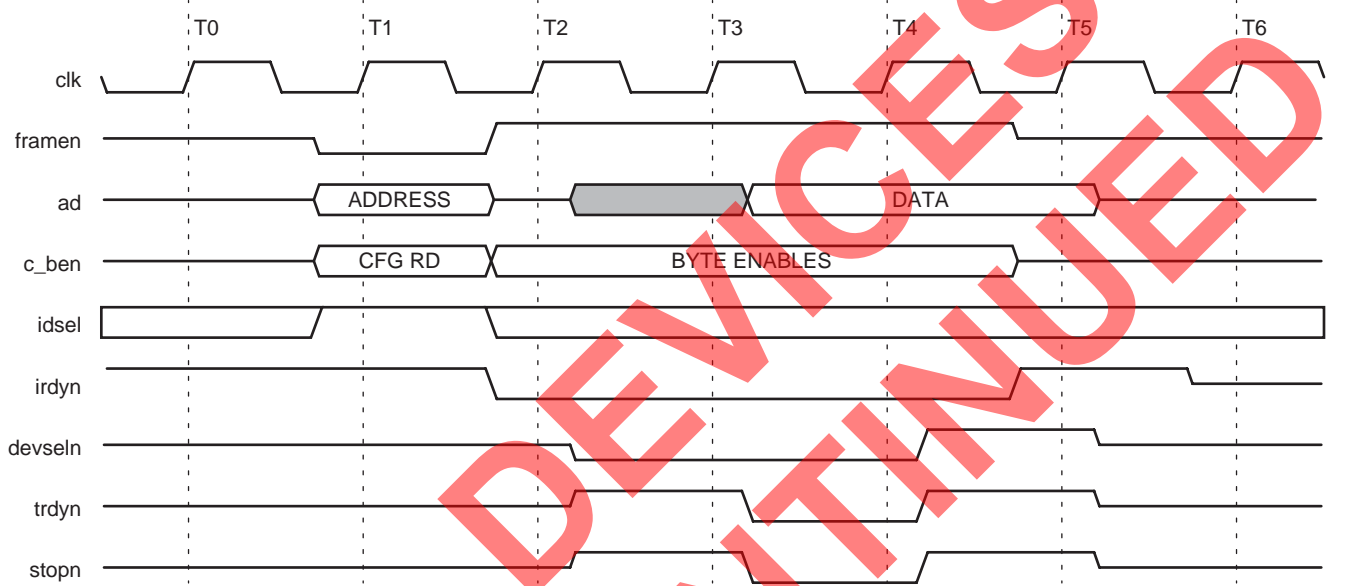

5-7375(F)

Figure 23. Target Configuration Read (PCI Bus, 32-Bit)

PCI Bus Core Target Controller Detailed Description (continued)

Example: Target Single Read I/O, Delayed Transaction

Figure 24 shows the timing on the PCI for a Target I/O read that is handled as a delayed transaction ($deltrn = 0$).

Three transactions are shown. The first is the initial read in which the Target latches the command, address, and byte enables. The Target then issues a retry, obligating the remote Master to continue to issue that identical request until data is transferred. Meanwhile, the latched information will be transferred to the FPGA application via the Target FIFO interface. In the second transaction, as shown in Figure 24, all subsequent read or write requests to memory or I/O space will result in retries, until the read data FIFO becomes nonempty. The third transaction is the final transaction that completes the transfer of read data. The timing on this third transaction is identical to the timing of the first except that **trdyn** accompanies **stopn** to indicate the disconnect with data.

The FPGA interface timing is shown in Figure 27 and Figure 28 for dual- and quad-port respectively. The FPGA interface timing is similar for all Target reads and is described below in the Single Target Read FIFO Interface section.

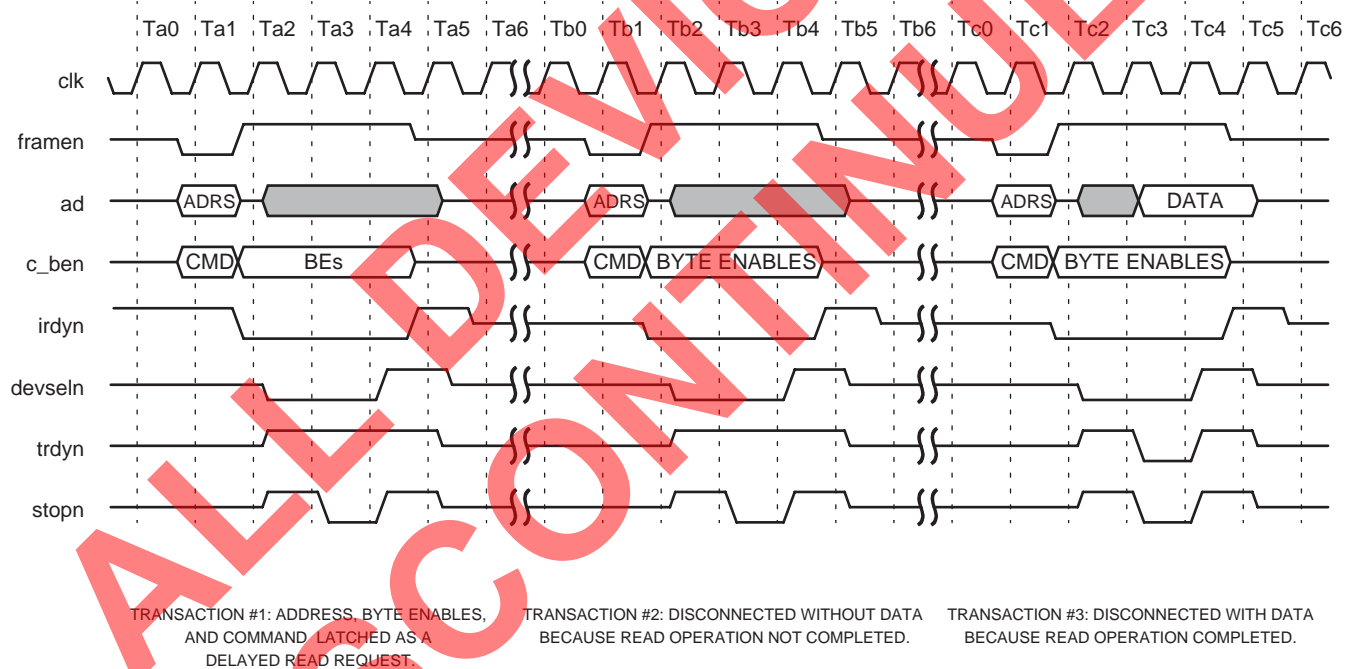

5-7547(F)

Figure 24. Target I/O Read, Delayed (PCI Bus, 32-Bit)

PCI Bus Core Target Controller Detailed Description (continued)

Example: Target Read I/O, Nondelayed Transaction

Figure 25, shows the timing on the PCI bus for a Target I/O read that is handled as nondelayed transaction (**deltrn** = 1, **trburstpendn** = 0); that is, the operation waits on the PCI bus while the FPGA application is notified via the Target FIFO Interface. The Target accepts the transaction without issuing an immediate retry, but inserts wait-states (up to 16 or 32) until the requested data is placed in the Target read FIFO. If the FPGA application cannot fetch the data within the initial/subsequent latency time, the Target issues a retry. The Target terminates the I/O read request by disconnecting with data on the first word transformed, thus disallowing bursting.

The FPGA interface timing is as shown in Figure 27 and Figure 28 for dual- and quad-port respectively. The FPGA interface timing is similar for all Target reads and is described below in the Single Target Read FIFO Interface section.

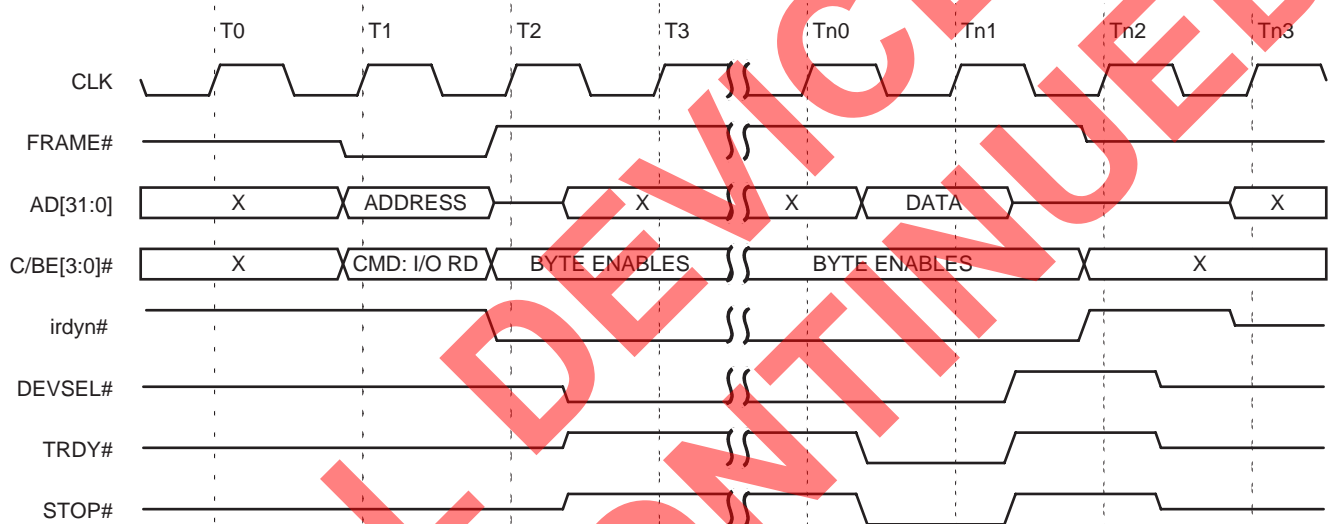

5-7546(F)

Figure 25. Target I/O Read, Nondelayed (PCI Bus, 32-Bit)

PCI Bus Core Target Controller Detailed Description (continued)

Example: Target Read Memory, Single-Word, Delayed Transaction

Figure 26 shows the timing on the PCI bus interface for a Target single 32-bit memory read handled as a delayed transaction ($deltrn = 0$). The timing on the PCI interface (Figure 26) is similar to that of a delayed I/O read (Figure 24) except that **stopn** is not asserted here to cause disconnect with data.

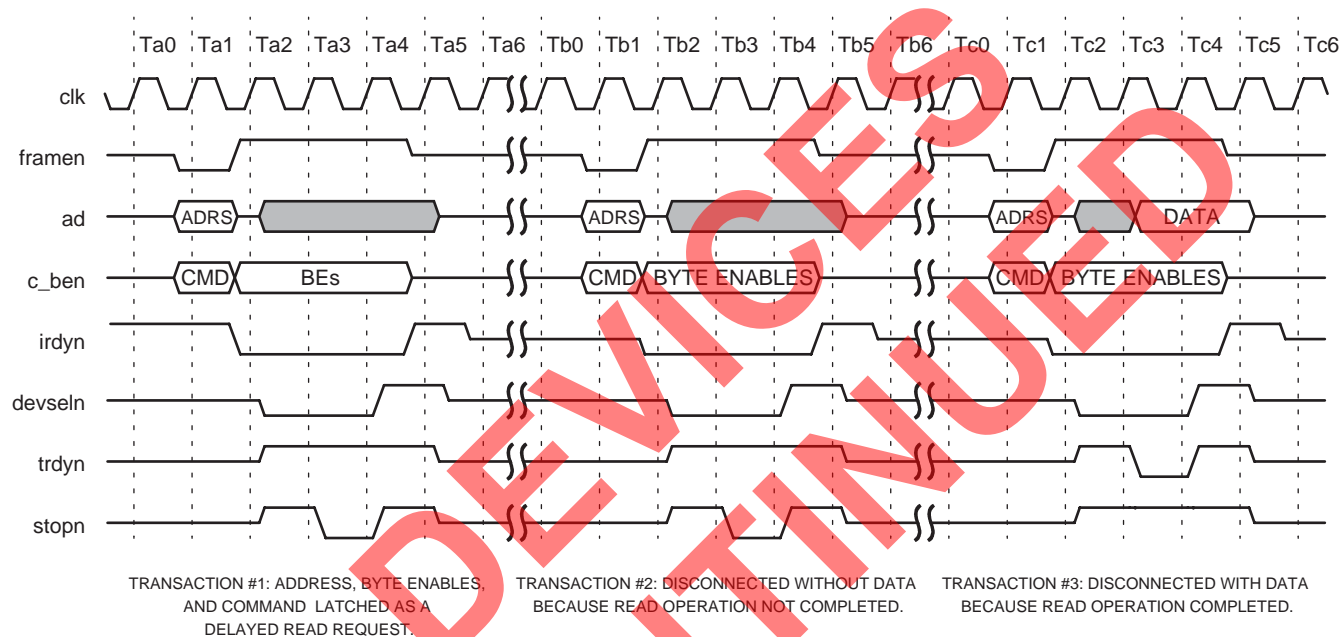

5-7549(F)

Figure 26. Target Single Memory Read, Delayed (PCI Bus, 32-Bit)

The FPGA interface timing is as shown in Figure 27 and Figure 28 for dual- and quad-port respectively. The FPGA interface timing is similar for all Target reads and is described below in the Single Target Read FIFO Interface section.

PCI Bus Core Target Controller Detailed Description (continued)

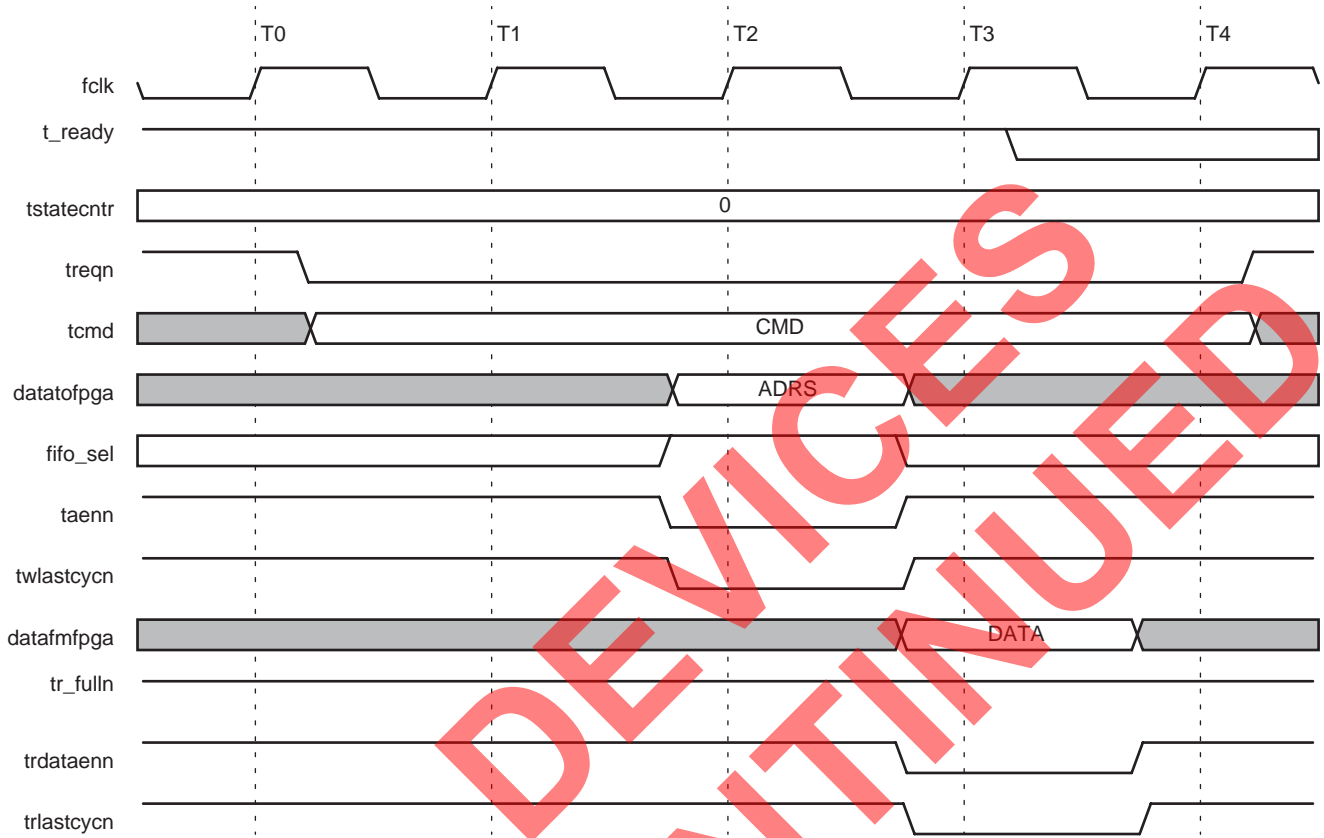

5-7356(F)

Figure 27. Target Read Single (FIFO Interface, Dual-Port)

PCI Bus Core Target Controller Detailed Description (continued)

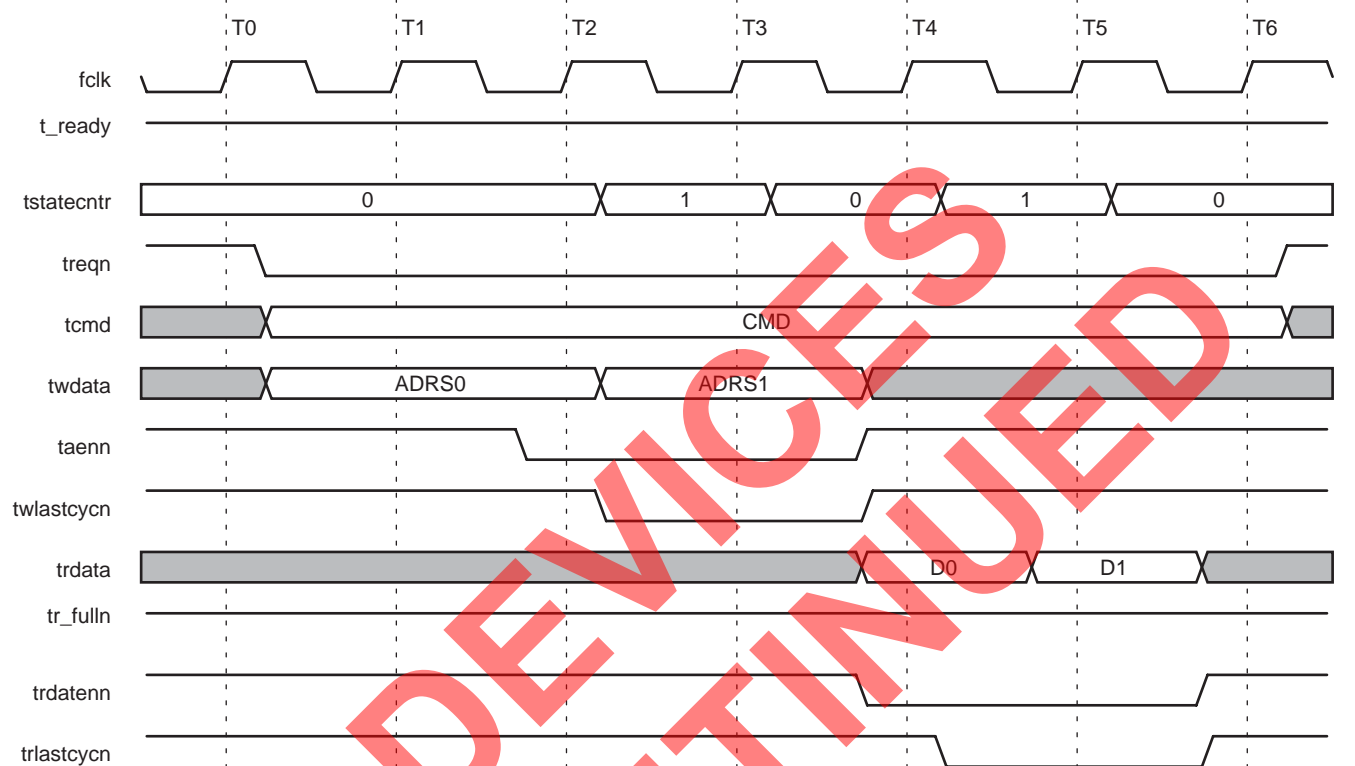

5-7364(F)

Figure 28. Target Read Single (FIFO Interface, Quad-Port)

PCI Bus Core Target Controller Detailed Description (continued)

Example: Target Read Memory, Single-Word, Nondelayed Transaction

Figure 29 shows the timing on the PCI bus for a Target single memory read that is handled as nondelayed (**deltrn** = 1, **trburstpendn** = 0); that is, the operation waits on the PCI bus while the FPGA application is notified via the Target FIFO Interface. The Target accepts the transaction without issuing an immediate retry, but inserts wait-states (up to 16 or 32) until data is in placed in the Target read FIFO. If the FPGA application cannot provide data within the initial latency time, the Target issues a retry. The Target terminates the single read request normally with data on the first word transformed.

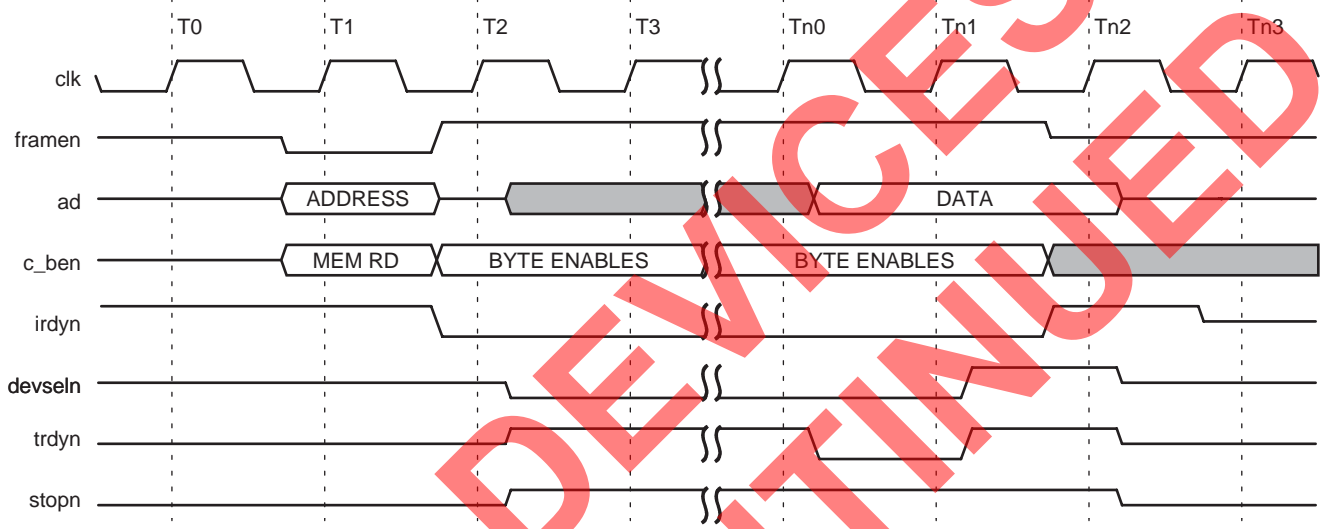

5-7548(F).

Figure 29. Target Memory Read Single, Nondelayed Transaction (PCI Bus, 32-Bit)

Single Target Read FIFO Interface

The FIFO interface timing is as shown in Figure 27 and Figure 28 for dual- and quad-port respectively. The Target FIFO interface timing to the FPGA application is similar for all Target reads: delayed Target I/O read, nondelayed Target I/O read, delayed Target memory read, and nondelayed Target memory read. The timing on the FIFO interface (Figure 27 for dual-port) shows the first indication to the FPGA application that a new operation has begun by the assertion of Target request (**treqn**). The FPGA application begins the command/address phase by asserting Target address enable (**taenn**) and accepting the command from the **tcmd** bus and address from bus **datatofpga** (with **fifo_sel** = 1). A burst operation and dual-address indication accompanies the address on **datatofpgax[1]** and **datatofpgax[0]** respectively. The FPGA application continues to receive address data until **twlastcycn** is asserted indicating the end of the command/address phase. See command/address section for notes regarding address transfer and alignment.

The read data phase will follow, by deassertion of **taenn**, and assertion of Target read data enable (**trdataenn**). **trdataenn** can only be asserted while **tr_fulln** is deasserted, indicating that space is available in the read data FIFOs. While **trdataenn** is asserted, the FPGA application will transfer Target read data on bus **datafmfpga** to the read data FIFOs. The FPGA application is informed when the last component of the data phase was received when **trlastcycn** is asserted. In a single access on a 32-bit PCI bus (**pci_64bit** = 0), this is on the first data phase. Assuming this is a single access, (**datatofpgax[1]** = 0 during command/address phase), the first and only data phase is the last data of the read data phase. After receiving **trlastcycn** at the end of the data phase, **trdataenn** must be deasserted by the FPGA application. **trlastcycn** can only be asserted when **trdataenn** is asserted. See Read Data Transfer section for details on **trlastcycn**.

PCI Bus Core Target Controller Detailed Description (continued)

For quad-port mode (Figure 28), the address is transferred on the bus **twdata** in 16-bit segments. If necessary, the address will be split into two 16-bit components with the LSB being transferred first. A burst operation and dual-address indication accompanies the address on **twdata[17]** and **twdata[16]** respectively. Assuming a BAR size greater than 16 bits, the address phase will require two clock cycles, and **twlastcycn** will be asserted on the final or MSB component of the address. The data phase will also require two clock cycles to transfer every 32-bit read data word across the 16-bit bus from the FPGA application. **trlastcycn** will be deasserted for all 16-bit components of the write data phase, except for the final 16-bit component where it is asserted. **trlastcycn** can only be asserted when **trdataenn** is asserted. See Read Data Transfer section for details on **trlastcycn**.

Example: Target Read Memory Burst, Delayed Transaction

Figure 30 shows the timing on the PCI bus for a Target memory burst read of four 32-bit words handled as a delayed transaction (**deltrn** = 0). On the PCI interface (Figure 30), three transactions are shown. In the first, the Target responds to the request after determining that the address matches one of its BARs by asserting **devseln**. However, since delayed transaction has been specified by the FPGA application (**deltrn** = 0), the Target issues a retry since the Target read FIFO is empty. The Target waits for the FPGA application to load the Target read FIFO. Until this occurs, all memory and I/O accesses result in retries as shown by the second transaction in Figure 30. After the required read data is loaded, the actual data transfer will occur as shown in the third transaction in Figure 30.

The FPGA interface timing is as shown in Figure 31 and Figure 32 for dual- and quad-port respectively. The Target FIFO interface timing to the FPGA application is similar for all Target burst reads and is described below for the Target Read Burst FIFO interface.

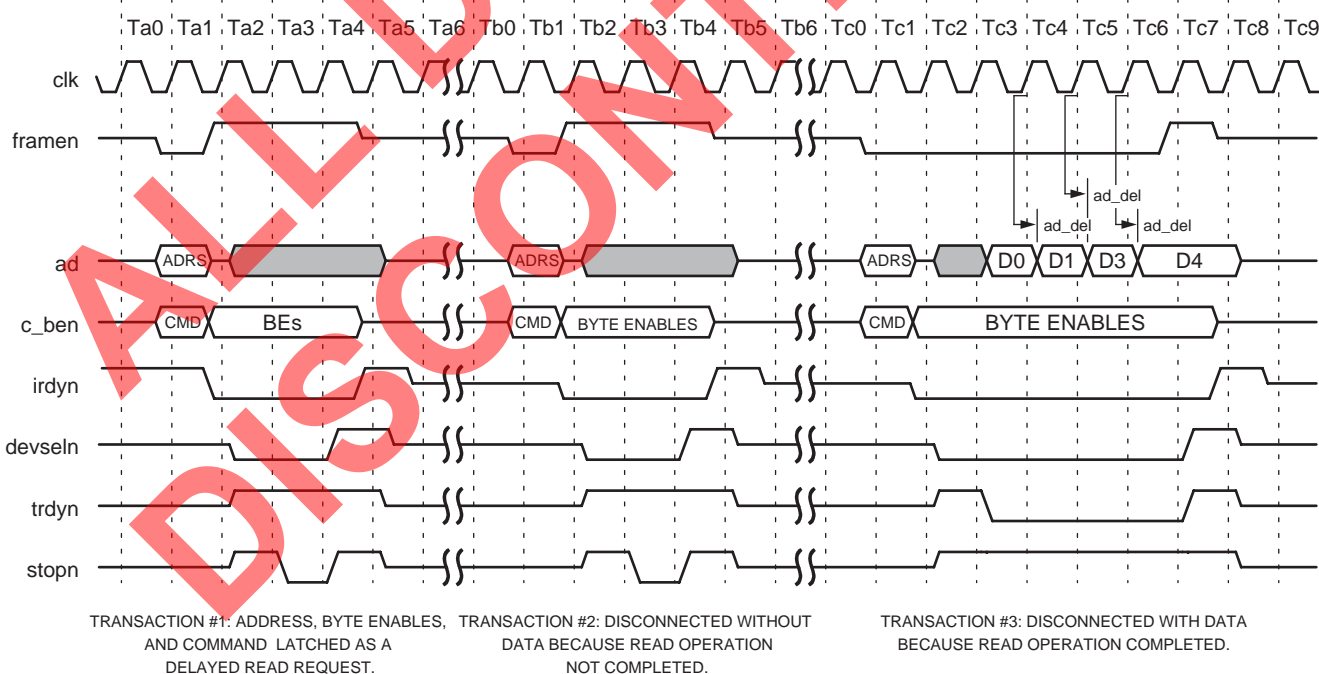

5-7551(F)

Figure 30. Target Burst Memory Read, Delayed (PCI Bus, 32-Bit)

PCI Bus Core Target Controller Detailed Description (continued)

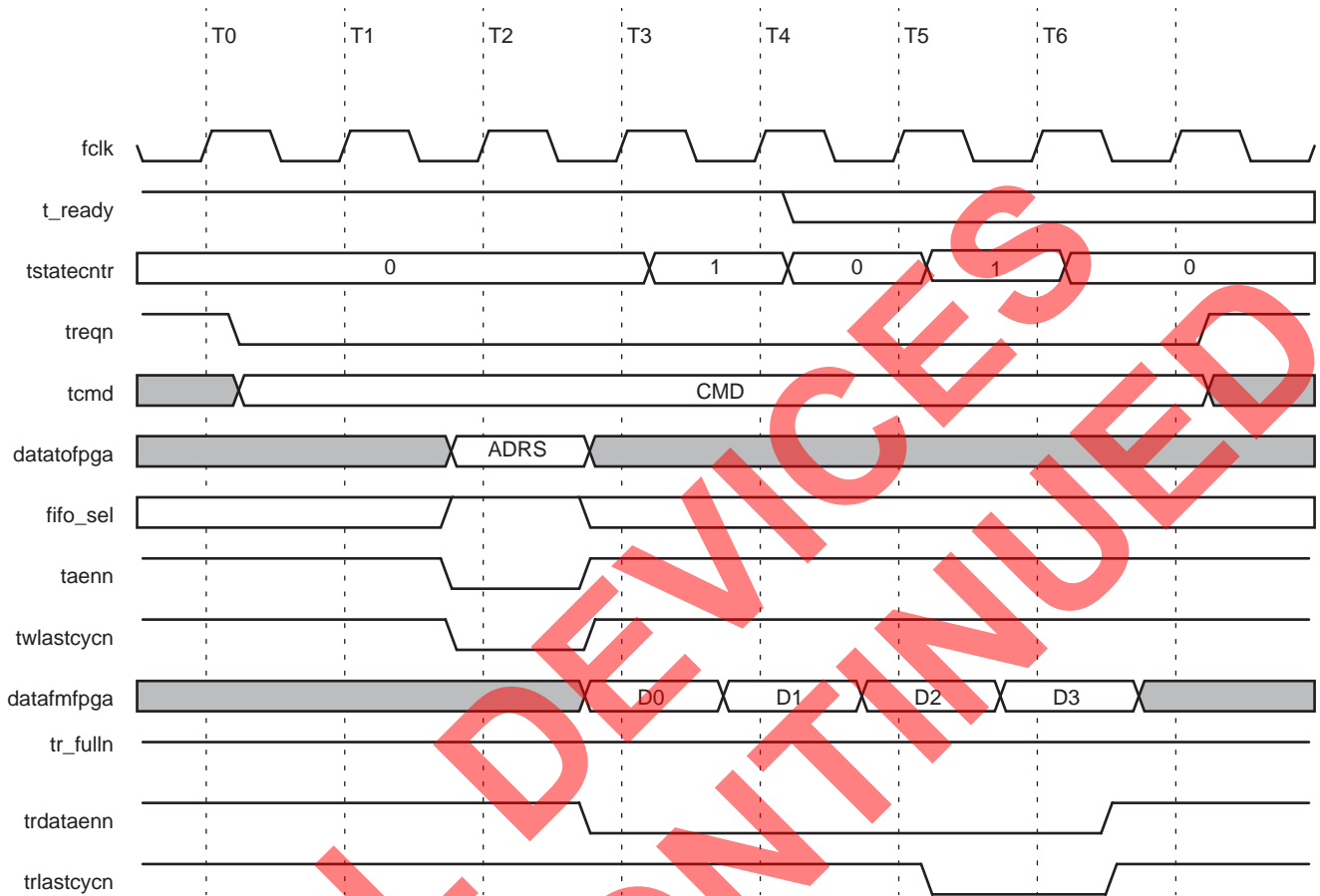

5-7357(F)

Figure 31. Target Read Burst (FIFO Interface, Dual-Port)

PCI Bus Core Target Controller Detailed Description (continued)

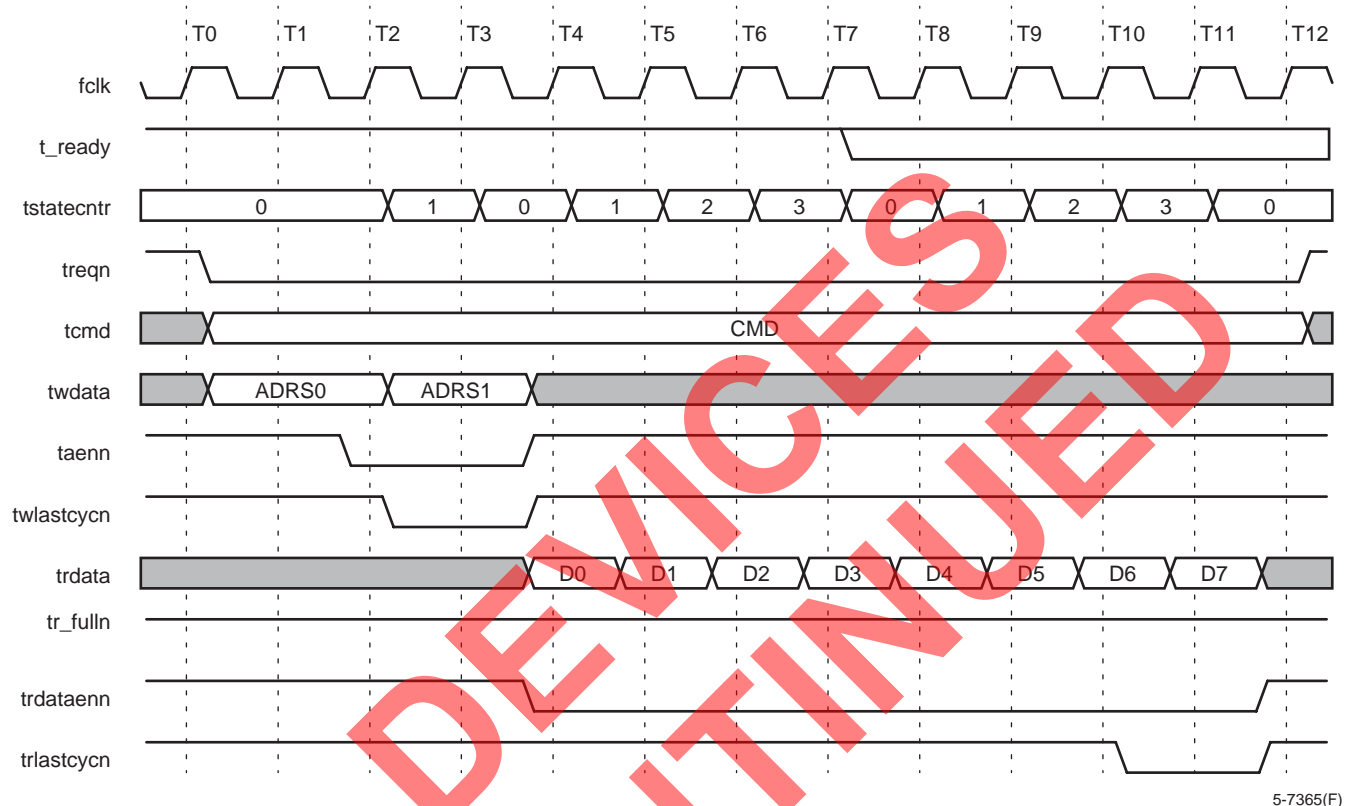

Figure 32. Target Read Burst (FIFO Interface, Quad-Port)

Target Read Memory Burst, Nondelayed Transaction

Figure 33 shows the timing on the PCI bus interface, for a Target memory burst read of four 32-bit words handled as a nondelayed transaction ($deltrn = 1$, $trburstpendn = 0$). The operation starts and waits on the PCI bus while the FPGA application is notified via the Target FIFO Interface. This is similar to that of an delayed Target burst read (Figure 30), except the Target accepts the transaction without issuing an immediate retry, but inserts wait-states (up to 16 or 32) until data is in placed in the Target read FIFO. If the FPGA application cannot provide data within the initial latency time, the Target issues a retry.

Target Read Burst FIFO Interface

The timing on the FPGA interface (Figure 31 for dual-port) shows the first indication to the FPGA application that a new operation has begun by the assertion of Target request (**treqn**). The FPGA application begins the command/address phase by asserting Target address enable (**taenn**) and accepting the command from the **tcmd** bus and address from bus **datatofpga[0]** (with **fifo_sel = 1**). A burst operation and dual-address indication accompanies the address on **datatofpgax[1]** and **datatofpgax[0]** respectively. The FPGA application continues to receives address data until **twlastcycn** is asserted indicating the end of the command/address phase. See Command/Address Setup section (see page 52) for notes on address transfer and alignment.

PCI Bus Core Target Controller Detailed Description (continued)

The read data phase will follow, by deassertion of **taenn**, assertion of Target read data enable (**trdataenn**). **trdataenn** can only be asserted while **tr_fulln** is deasserted, indicated that space is available in the read data FIFOs. While **trdataenn** is asserted, the FPGA application will transfer Target read data on bus **datafmfpga** to the read data FIFOs. The FPGA application is informed when the last component of the data phase is needed when **trlastcycn** is asserted. In a burst access, this is during the last data phase. Assuming this is a burst access, (**datatofpgax[1] = 1** during command/address phase), **trlastcycn** is deasserted during the read data phase except for the last data of the read data phase. After receiving **trlastcycn** at the end of the data phase, **trdataenn** must be deasserted by the FPGA application. **trlastcycn** can only be asserted when **trdataenn** is asserted. See Read Data Transfer section for details on **trlastcycn**.

For quad-port mode (Figure 32), the address data is transferred on the bus **twdata** in 16-bit segments. The address will be split into two 16-bit components with the LSB being transferred first. A burst operation and dual-address indication accompanies the address on **twdata[17]** and **twdata[16]** respectively. Assuming a BAR size greater than 16 bits, the address phase will require two clock cycles for a 32-bit address, and **twlastcycn** will be asserted on the final or MSB component of the address. The data phase will also require two clock cycles to transfer every 32-bit read data word across the 16-bit bus **trdata** from the FPGA application. **trlastcycn** will be deasserted for all 16-bit components of the read data phase, except for the final 16-bit component where it is asserted.

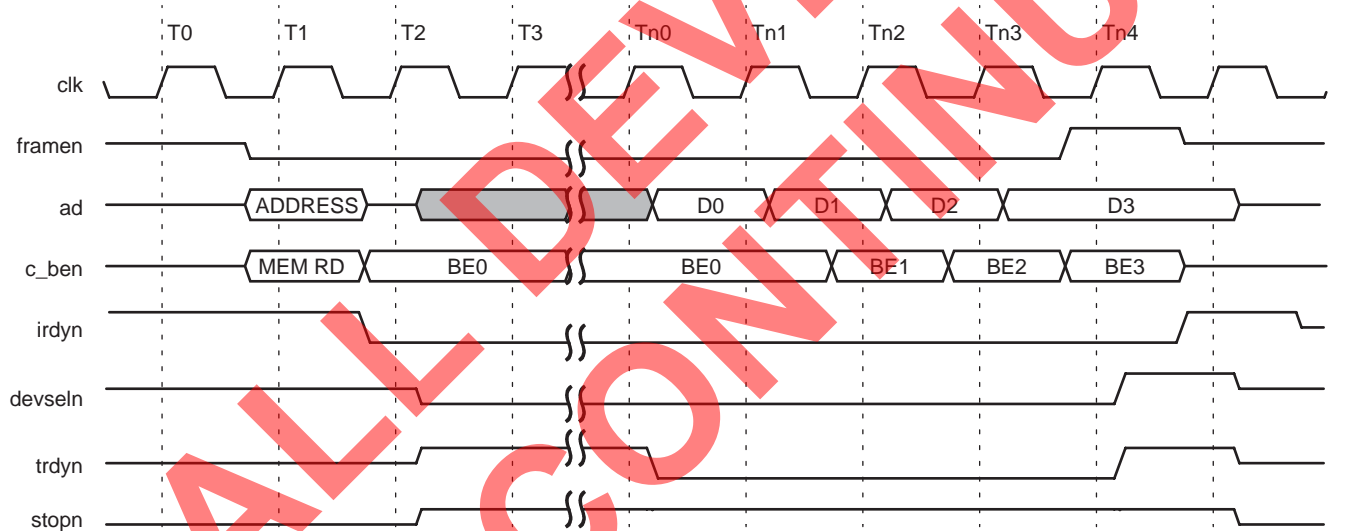

5-7550(F)

Figure 33. Target Memory Burst Read, Nondelayed (PCI Bus, 32-Bit)

PCI Bus Core Target Controller Detailed Description (continued)

Table 22. Dual-Port Target Read

tstatecnr	Next State of tstatecnr	Description	Data on Bus datatofpgax[3:0] datatofpga[31:0]	Data on Bus datafmfpga[31:0]	Notes
0	0	Idle	XXXXXXXX16	—	1
0	1 or 0	Address[31:0]	X2, Burst, Dual-Address, PCIAddress[31:0]	PCIData[31:0]	2, 3, 4, 5, 6
1	0	Address[63:32]	X2, Burst, Dual-Address, PCIAddress[63:32]	PCIData[63:32]	2, 3, 4, 5, 6

1. When **treqn** is deasserted high, the Target interface is idle.
2. When **taenn** is asserted low, a command/address phase is in progress.
3. **taenn** must be asserted low for command/address data to transfer and state to change.
4. **taenn** must be deasserted high and **trdataenn** must be asserted low to execute the data phase.
5. Next state = 0 if **trlastcycn** is asserted low (end of Target read data).
6. Next state = 0 if **twlastcycn** is asserted low (end of Target command/address phase).

Table 23. Quad-Port Target Read

tstatecnr	Next State of tstatecnr	Description	Data on Bus twdata[17:0]	Data on Bus trdata[15:0]	Notes
0	0	Idle	XX2, XXXX16	—	1
0	1 or 0	Address[15:0]	Burst, Dual-Address, PCIAddress[15:0]	PCIData[15:0]	2, 3, 4, 6
1	2 or 0	Address[31:16]	Burst, Dual-Address, PCIAddress[31:16]	PCIData[31:16]	2, 3, 4, 5, 6
2	3 or 0	Address[47:32]	Burst, Dual-Address, PCIAddress[47:32]	PCIData[47:32]	2, 3, 4, 6
3	0	Address[63:48]	Burst, Dual-Address, PCIAddress[63:48]	PCIData[63:48]	2, 3, 4, 5, 6

1. When **treqn** is deasserted high, the Target interface is idle.
2. When **treqn** is asserted low, a command/address phase is in progress.
3. **taenn** must be asserted low for command/address data to transfer and state to change.
4. **taenn** must be deasserted high and **trdataenn** must be asserted low to execute the data phase.
5. Next state = 0 if **trlastcycn** is asserted low (end of Target read data).
6. Next state = 0 if **twlastcycn** is asserted low (end of Target command/address phase).

PCI Bus Core Target Controller Detailed Description (continued)

Clocking Options at FPGA/Embedded Core Boundary

The OR3TP12 PCI bus core is divided into two clock domains by two sets of dual-port FIFOs, one set dedicated to each Target and Master function. The FPGA supplies at least one clock, while the PCI bus provides the second clock (**clk**).

The Master and Target FIFO interfaces are always independently clocked on the FPGA side by either **fclk1** or **fclk2**. The clocks used for the Master FIFO and Target FIFO interfaces to the FPGA application can be independent when the interface is configured in quad-port mode, but they must use the same clock signal for dual-port mode. For dual-port, only one clock port is active while the other is tied inactive.

All transfers to/from the FIFO interfaces are synchronized to **fclk1** and/or **fclk2**. Which port is used for synchronization is decided by the FPSC configuration manager for the Master and Target FIFO interfaces. The ispLEVER software will minimize the clock skew between the FFs involved in the data transfers and the appropriate synchronized clock port. The clock delay from the clock source to the **fclk1/2** port usually does not affect transfer across the Master or Target FIFO interface, since the interface is referenced from the clock port (**fclk1** or **fclk2**) and not the clock source driver.

Figure 34 illustrates the special clock paths provided to service the clocking needs of OR3TP12. The various clocking options shown in Figure 34 are discussed below.

PCI Clock as Interface Clock

The clock received from the PCI bus can be brought across the embedded core into the FPGA logic section and used as the clock for the entire OR3TP12, and even as the clock for the entire board on which the OR3TP12 resides. It is important that this signal be obtained via the embedded PCI bus core only since PCI rules allow for one load per agent on the PCI bus clock. The OR3TP12 incorporates a clock tree for distributing the PCI clock; these lines are hard-connected in the PCI bus core's circuitry and are passed up onto the FPGA portion's clock grid. From there, the clock can feed all PFUs, PIOs, **fclk1**, **fclk2**, and off-chip resources.

Local Clock as Interface Clock

The FIFO interface between the PCI bus core and the FPGA must use clocks sourced from the FPGA array. The Master and Target FIFO interfaces each have independent clock nets (**fclk1/2**) and can be connected to the same or separate clocks. Both the Master and Target FIFO interface can be independently configured to use any clock located in the FPGA, or provided externally.

The clocks for the Master and Target FIFO Interface are fed from specific vertical clock spines, namely, the spines in PLC columns five and 13. Consequently, minimum clock net delay is obtained by feeding external clocks from I/O pads in locations on the top of the array near these splines. Depending on which spline (**fclk1** or **fclk2**) is used to distribute the clock to the Master and Target FIFO Interface, it is recommended to use a PIO that lies in that same column as the spline. For **fclk1** (which lies in column 13), use a PIO in PT13A-PT14D. For **fclk2** (which lies in column five), use a PIO in PT5A-PT6D. If the user chooses the FAST_CLOCK or EXPRESS_CLOCK as a source for the OR3TP12 clock, additional clock delay may be introduced. Nevertheless, clocks can be fed from any I/O pad, from express clock inputs, or from internal logic, and can be fed via the PCM.

PCI Bus Core Target Controller Detailed Description (continued)

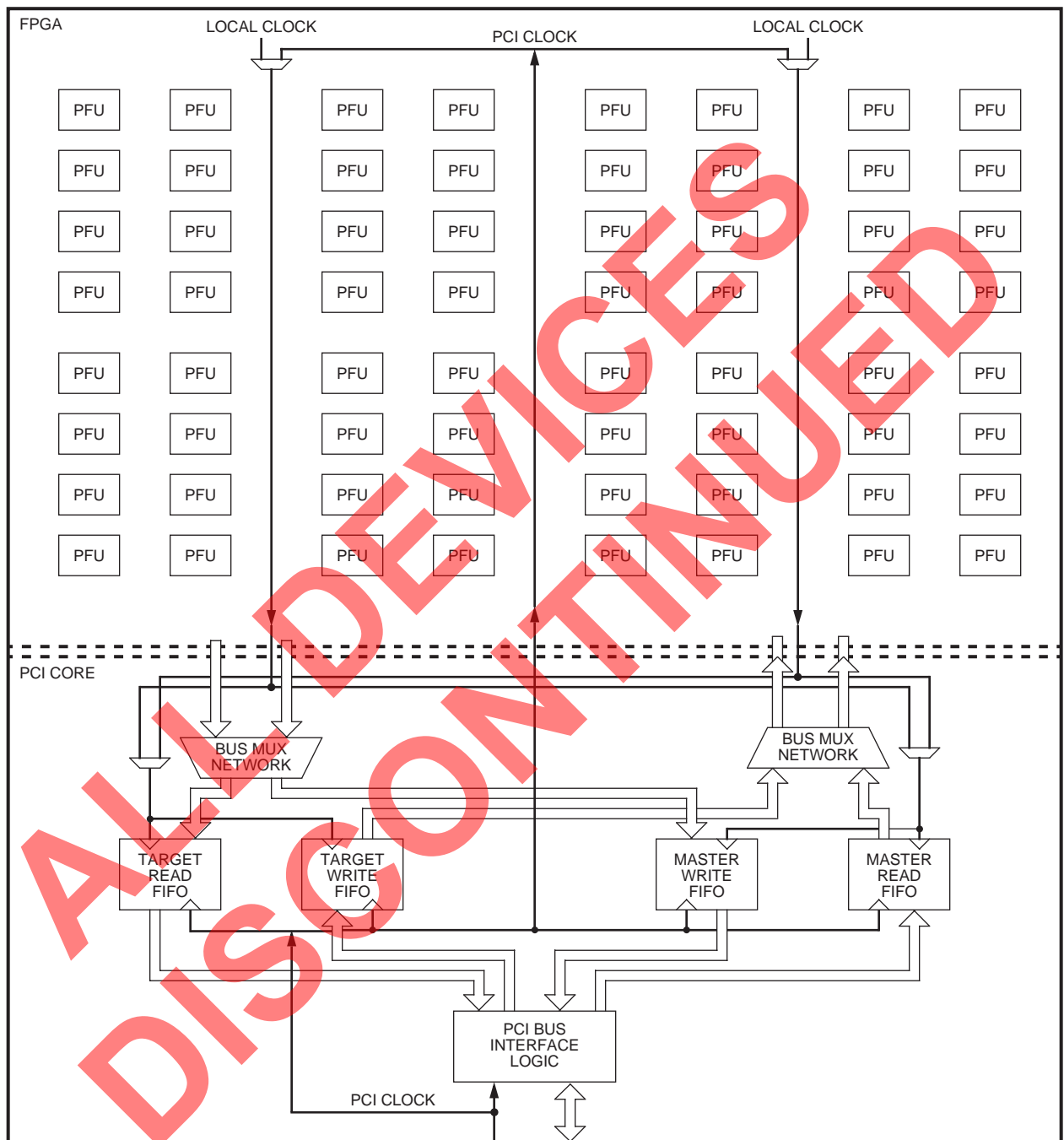

5-7553 (F)

Figure 34. FPSC Block Diagram and Clock Network

PCI Bus Core Target Controller Detailed Description (continued)

Configuration Space of the PCI Bus Core

The following section describes the configuration space of the PCI bus core, as defined in the PCI Specification and specific additions to this implementation. Note that the term configuration has two meanings: in the FPGA context, it refers to the programming of the FPGA's resources to define its functionality, and in the PCI context, it refers to the process of initializing the personality of the PCI agent. Normally, this agent will reside at a unique location or card slot defined by a physical address line **idsel**. The PCI's configuration space is described as follows.

PCI Bus Core Configuration Space Organization

Table 24 shows the layout of the PCI bus core's configuration space. The header type is 00 hex (non-PCI-to-PCI bridge). All required features and many optional features are implemented. In this implementation, the defined configuration space extends beyond 0x3F hex, and includes provisions for hot swap and FPGA configuration via the PCI bus. Table 25 further details the content and function of each register in the PCI configuration space.

Table 24. Configuration Space Layout

31	16	15	0	
Device ID		Vendor ID		00h
Status		Command		04h
Class Code		Revision ID		08h
BIST	Header Type	Latency Timer	Cache Line Size	0Ch
Base Address Registers				10h
				14h
				18h
				1Ch
				20h
Cardbus CIS Pointer				24h
Subsystem ID		Subsystem Vendor ID		28h
Expansion ROM Base Address				2Ch
Reserved		Cap_Ptr		30h
Max_Lat	Min_Gnt	Interrupt Pin	Interrupt Line	34h
Reserved		FPGA Configuration Command-Status Register		3Ch
FPGA Configuration Data Register				40h
Scratch Register				44h
Reserved				48c
Reserved				40c
Reserved	HS_CSR	Next Item	Capability ID	48h
Reserved				54h
Reserved				thru
Reserved				FFh

PCI Bus Core Target Controller Detailed Description (continued)

Table 25. Configuration Space Assignment

Bytes	Width	Bit	Description	Read/Write	Initial Value after FPGA Configuration
00—01	16	—	Vendor ID	Read Only	11C1h (Lattice)
02—03	16	—	Device ID	Read Only	5400h (OR3TP12)
04—05	16		Command:		
		0	Enable I/O Space	Read/Write	0
		1	Enable Memory Space	Read/Write	0
		2	Enable Bus Master	Read/Write	Note 1
		3	Enable Special Cycle	Read Only	0
		4	Enable Mem Wr & Inv	Read Only	0
		5	Enable VGA Palette Snoop	Read Only	0
		6	Enable Par Err Response	Read/Write	0
		7	Enable Stepping	Read Only	0
		8	Enable serrn	Read/Write	0
		9	Enable Fast Back-to-Back	Read/Write	0
		15—10	Reserved	Read Only	zeros
06—07	16		Status:		
		3—0	Reserved	Read Only	zeros
		4	Capabilities List	Read Only	1
		5	66 MHz Capable	Read Only	1
		6	UDF Supported	Read Only	0
		7	Fast Back-to-Back	Read Only	1
		8	Master Data Parity Error	Note 2	0
		10—9	devseln Timing	Read Only	01b (medium)
		11	Target Abort Signaled	Note 2	0
		12	Target Abort Received	Note 2	0
		13	Master Abort Received	Note 2	0
		14	System Error Signaled	Note 2	0
		15	Parity Error Detected	Note 2	0

- These values are intended to be custom assigned, per the intended application, by assigning constants via the FPGA configuration manager.
- These bits exhibit special behavior per the PCI Specification:
 - Reads behave normally.
 - Writing a one clears the bit to 0.
 - Writing a 0 has no effect on the bit.
- Bytes 10—27 hex contain the base address registers (BARs).
 - Any legal combination of memory and I/O BARs is permitted, as long as 64-bit BARs are naturally aligned, that is, they occupy bytes 10—17, 18—1F, or 20—27 hex.
 - Memory BARs may be marked as prefetchable/nonprefetchable by setting/resetting bit 3; however, the PCI bus core's behavior is not affected by this setting. In particular, the Target read operation may discard unused FIFO read-ahead data even though the data space is marked as nonprefetchable (this is not a violation since the nonprefetchable bit only says that data can't be discarded once it has been sent over the PCI bus; nevertheless, caution must be exercised when this bit is reset).
- These signals are tied to the FPGA signal of the same name and are not initialized.
- These bits exhibit special behavior per the CompactPCI Hot Swap Specification:
 - Reads behave normally.
 - Writing a one clears the bit to 0.
 - Writing a 0 has no effect on the bit.
- This 32-bit register is used during manufacturing test. Writes are not allowed; reads are allowed and cause no side effects, but the value returned is undefined.

PCI Bus Core Target Controller Detailed Description (continued)

Table 25. Configuration Space Assignment (continued)

Bytes	Width	Bit	Description	Read/Write	Initial Value after FPGA Configuration
08	8	—	Revision ID	Read Only	Note 1
09—0B	24	—	Class Code	Read Only	Note 1
0C	8	—	Cache Line Size	Read Only	zeros
0D	8	7—3 2—0	Latency Timer: Programmable Portion Granularity eight clks	Read/Write Read Only	Near 1 zeros
0E	8	—	Header Type	Read Only	00h
0F	8	—	BIST	Read Only	zeros
10—27	192	—	Base Address Register	Note 3	Note 1
28—2B	32	—	Cardbus CIS Pointer	Read Only	zeros
2C—2D	16	—	Subsystem Vendor ID	Read Only	zeros
2E—2F	16	—	Subsystem ID	Read Only	Note 1
30—33	32	—	Expansion ROM Base Address	Read Only	zeros
34	8	—	Capabilities Pointer	Read Only	50h
35—37	24	—	(Reserved)	Read Only	zeros
38—3B	32	—	(Reserved)	Read Only	zeros
3C	9	—	Interrupt Line	Read/Write	zeros
3D	8	—	Interrupt Pin	Read Only	01h (intan)
3E	8	—	Min_Gnt	Read Only	Note 1
3F	8	—	Max_Lat	Read Only	Note 1

1. These values are intended to be custom assigned, per the intended application, by assigning constants via the FPGA configuration manager.
2. These bits exhibit special behavior per the PCI Specification:
 - Reads behave normally.
 - Writing a one clears the bit to 0.
 - Writing a 0 has no effect on the bit.
3. Bytes 10—27 hex contain the base address registers (BARs).
 - Any legal combination of memory and I/O BARs is permitted, as long as 64-bit BARs are naturally aligned, that is, they occupy bytes 10—17, 18—1F, or 20—27 hex.
 - Memory BARs may be marked as prefetchable/nonprefetchable by setting/resetting bit 3; however, the PCI bus core's behavior is not affected by this setting. In particular, the Target read operation may discard unused FIFO read-ahead data even though the data space is marked as nonprefetchable (this is not a violation since the nonprefetchable bit only says that data can't be discarded once it has been sent over the PCI bus; nevertheless, caution must be exercised when this bit is reset).
4. These signals are tied to the FPGA signal of the same name and are not initialized.
5. These bits exhibit special behavior per the CompactPCI Hot Swap Specification:
 - Reads behave normally.
 - Writing a one clears the bit to 0.
 - Writing a 0 has no effect on the bit.
6. This 32-bit register is used during manufacturing test. Writes are not allowed; reads are allowed and cause no side effects, but the value returned is undefined.

PCI Bus Core Target Controller Detailed Description (continued)

Table 25. Configuration Space Assignment (continued)

Bytes	Width	Bit	Description	Read/Write	Initial Value	
40—41	16		FPGA Config. Command-Status Register:			
		15	Gsr	PCI Core Global Set/Reset	Read/Write	0
		14	ConfigFPGA	Enable FPGA Config.	Read/Write	0
		13	RdCfgN	Enable Readback	Read/Write	1
		12	PrgmN	Reset FPGA Config. Logic	Read/Write	1
		11	FastSlowN	Fast/Slow Config. Clock	Read/Write	0
		10	BitErr_1	Error Signal from FPGA	Read Only	0
		9	BitErr_0	Error Signal from FPGA	Read Only	0
		8	—	Reserved	Read Only	0
		7	—	Reserved	Read Only	0
		6	—	Reserved	Read Only	0
		5	SRFull	Shift Reg. Full	Read Only	0
		4	SREmpty	Shift Reg. Empty	Read Only	0
3	HandShakeError	Shift Reg. Error	Read/Only	0		
2	InitN	FPGA's INITN	Read Only	Note 4		
1	Done	FPGA's DONE	Read Only	Note 4		
0	ASBMODE	Ready to Config	Read Only	1		
42—43	16	—	(Reserved)	Read Only	zeros	
44—47	32	—	FPGA Config. Data Register	Read/Write	zeros	
48-4B	32	—	Scratch Register	Read/Write	zeros	
4C	32	—	Reserved for Manufacturing Testing	Note 6	Note 6	
50	8	—	Capability ID	Read Only	06h (Hot Plug)	
51	8	—	Next Item	Read Only	00h (Last item)	
52			Hot Swap Control Status Register:			
	7	—	INS	Freshly Inserted	Note 5	1
	6	—	EXT	Pending Extraction	Note 5	0
	5	—	—	Reserved	Read Only	0
	4	—	—	Reserved	Read Only	0
	3	—	LOO	LED ON/OFF	Read/Write	0
	2	—	—	Reserved	Read Only	0
	1	—	EIM	enumn Signal Mask	Read/Write	0
0	—	—	Reserved	Read Only	0	

- These values are intended to be custom assigned, per the intended application, by assigning constants via the FPGA configuration manager.
- These bits exhibit special behavior per the PCI Specification:
 - Reads behave normally.
 - Writing a one clears the bit to 0.
 - Writing a 0 has no effect on the bit.
- Bytes 10—27 hex contain the base address registers (BARs).
 - Any legal combination of memory and I/O BARs is permitted, as long as 64-bit BARs are naturally aligned, that is, they occupy bytes 10—17, 18—1F, or 20—27 hex.
 - Memory BARs may be marked as prefetchable/nonprefetchable by setting/resetting bit 3; however, the PCI bus core's behavior is not affected by this setting. In particular, the Target read operation may discard unused FIFO read-ahead data even though the data space is marked as nonprefetchable (this is not a violation since the nonprefetchable bit only says that data can't be discarded once it has been sent over the PCI bus; nevertheless, caution must be exercised when this bit is reset).
- These signals are tied to the FPGA signal of the same name and are not initialized.
- These bits exhibit special behavior per the *CompactPCI* Hot Swap Specification:
 - Reads behave normally.
 - Writing a one clears the bit to 0.
 - Writing a 0 has no effect on the bit.
- This 32-bit register is used during manufacturing test. Writes are not allowed; reads are allowed and cause no side effects, but the value returned is undefined.

PCI Bus Core Target Controller Detailed Description (continued)

FPSC Configuration

The OR3TP12 FPSC provides the designer many FPGA configuration options. In addition to all the configuration options provided in the standard Series 3 architecture (except Master parallel mode) the OR3TP12 PCI FPSC can also be configured via the PCI interface. This feature is possible since the PCI interface is functional even before the FPSC has been configured. With this capability, many configuration schemes can be implemented. For example, a generic FPSC configuration can be loaded via a serial configuration PROM and updated via the PCI bus or the microprocessor interface. The FPSC can also be reprogrammed in the field, or the configuration can be dynamically modified to perform different tasks.

In a proprietary system or using one FPSC, the system software can locate the OR3TP12 by reading the vendor ID and device ID. Once identified, any PCI agent can write 32-bit words into the PCI Configuration register at address 0x44. This data is then serially shifted into the FPGA configuration logic, and distributed to the FPSC programmable resources as if the data was from an external serial PROM.

When multiple FPSCs are configured via the PCI interface in a standard PCI system, there can be an identification issue that must be resolved. The subsystem vendor ID and subsystem ID that reside at 2Ch—2Fh in the PCI configuration space contains default values after power-up, but before configuration. These identification values are usually needed by system software to identify where an OR3TP12 resides on the PCI bus, and which FPSC configuration bit stream to use for each OR3TP12. Therefore, for multiple FPSCs being configured employing the PCI interface, each should be initialized via a small serial PROM after power-up. This initialization bit stream will contain a unique subsystem and/or subsystem vendor ID (defined by the FPSC configuration manager) to describe each device operation in the system. For the FPGA design in the initialization bit stream, all embedded core input controls signals should be tied to their inactive state, especially **t_retrn** and **t_abort** to allow access to the PCI configuration space. To minimize the size of this initial bit stream, use the options available in bit stream generation process to use explicit addressing, and remove zero data frames.

This initial configuration bit stream is only required to provide correct subsystem vendor ID and subsystem ID values for system software use, but it may, in addition,

be the first version of the FPSC's application code. The PCI system software is then able to invoke the proper procedures that will reconfigure the OR3TP12 using the final version of the application.

FPGA Configuration via PCI Bus

The OR3TP12 is configured using registers located at 0x40 hex and 0x44 hex in the PCI configuration space. These registers are dedicated to the OR3TP12 configuration and readback functions and are detailed in Table 25. The FPGA configuration control-status register (FCCSR) is a 16-bit register at address 0x40 hex, and the FPGA configuration data register (FCDR) is a 32-bit register at address 0x44 hex.

The following is an example sequence which configures the OR3TP12 via the PCI interface:

1. Read the vendor ID (0x0) and device ID (0x0) registers. If the vendor ID is 0x11C1 hex, the vendor is Lattice. If the device ID is 0x5400 hex, the device is a Lattice OR3TP12 PCI FPSC.
2. If using an auxiliary initialization device (serial PROM, MPI, etc.) for subsystem ID identification setup, read the FCCSR (0x40) until DONE (bit 1) goes active-high. This indicates that the bit stream for subsystem ID initialization has loaded.
3. Read the class code, revision ID, subsystem vendor ID, and subsystem ID registers. This information has been programmed into the FPSC by an initialization bit stream or is the powerup default. It can be used by the configuration software to locate the correct OR3TP12 configuration bit stream and driver for the OR3TP12s application.
4. Read the FCCSR (0x40) until ASBMODE (bit 0) goes active-high, indicating that the JTAG controller is not in control of the FPGA configuration logic.
5. Toggle PRGRMN (bit 12) in the FCCSR (0x40) low to reset the current the FPGA configuration. Write to the FCCSR (0x40) three times, first with PRGMN high, then active-low, then high.
6. Write to the FCCSR (0x40) with ConfigFPGA (bit 14) active-high. This will initiate an FPGA configuration session via the PCI interface.
7. Read the FCCSR (0x40) until SREMPY (bit 4) goes active-high, indicating that the configuration shift register is ready for data.
8. Write a 32-bit word of OR3TP12 configuration data to the FCDR (0x44), noting that bit 32 will be the first bit to exit the shift register to the FPGA configuration logic.

FPGA Configuration Target Controller Data Format

The ispLEVER development system interfaces with front-end design entry tools and provides tools to produce a fully configured FPSC. This section discusses using the ispLEVER development system to generate configuration RAM data and then provides the details of the configuration frame format.

Using ispLEVER to Generate Configuration RAM Data

The configuration data bit stream defines the PCI embedded core configuration, the FPGA logic functionality, and the I/O configuration and interconnection. The data bit stream is generated by the ispLEVER development tools. The bit stream created by the bit stream generation tool is a series of ones and 0s used to write the FPSC configuration RAM. It can be loaded into the FPSC using one of the configuration modes discussed elsewhere in this data sheet.

For FPSCs, the bit stream is prepared in two separate steps in the design flow. The configuration options of the embedded core are specified using ORCA OR3TP12 design kit software at the beginning of the design process. This offers the designer a specific configuration to simulate and design the FPGA logic to. Upon completion of the design, the bit stream generator combines the embedded core options and the FPGA configuration into a single bit stream for download into the FPSC.

FPGA Configuration Data Frame

Configuration data can be presented to the FPSC in two frame formats: autoincrement and explicit. A detailed description of the frame formats are shown in Figure 35, Figure 36, and Table 26. The two modes are similar except that autoincrement mode uses assumed address incrementation to reduce the bit stream size, and explicit mode requires an address for each data frame. In both cases, the header frame begins with a series of ones and a preamble of 0010, followed by a 24-bit length count field representing the total number of configuration clocks needed to complete the loading of the FPSC.

The mandatory ID frame contains data used to determine if the bit stream is being loaded to the correct type of ORCA device (i.e., a bit stream generated for an OR3TP12 is being sent to an OR3TP12). Error checking is always enabled for Series 3+ devices, through the use of an 8-bit checksum. One bit in the ID frame also selects between the autoincrement and explicit address modes for this load of the configuration data.

A configuration data frame follows the ID frame. A data frame starts with a 01-start bit pair and ends with enough 1-stop bits to reach a byte boundary. If using autoincrement configuration mode, subsequent data frames can follow. If using explicit mode, one or more address frames must follow each data frame, telling the FPSC at what addresses the preceding data frame is to be stored (each data frame can be sent to multiple addresses).

Following all data and address frames is the postamble. The format of the postamble is the same as an address frame with the highest possible address value with the checksum set to all ones.

FPGA Configuration Target Controller Data Format (continued)

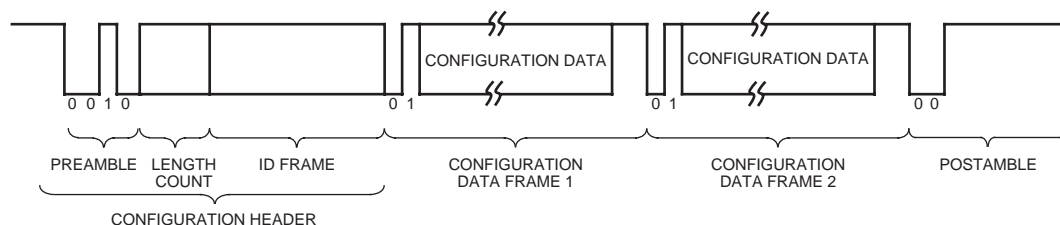

5-5759(F)

Figure 35. Serial Configuration Data Format—Autoincrement Mode

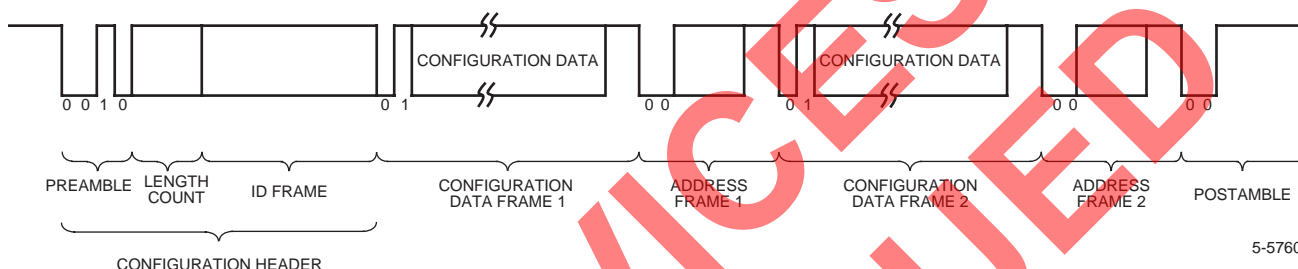

5-5760(F)

Figure 36. Serial Configuration Data Format—Explicit Mode

Table 26. Configuration Frame Format and Contents

Header	11110010	Preamble.
	24-bit Length Count	Configuration frame length.
	11111111	Trailing header—eight bits.
ID Frame	0101 1111 1111 1111	ID frame header.
	Configuration Mode	00 = autoincrement, 01 = explicit.
	Reserved [41:0]	Reserved bits set to 0.
	ID	20-bit part ID.
	Checksum	8-bit checksum.
Configuration Data Frame (repeated for each data frame)	11111111	Eight stop bits (high) to separate frames.
	01	Data frame header.
	Data Bits	Number of data bits depends upon device.
	Alignment Bits = 0	String of 0 bits added to bit stream to make frame header, plus data bits reach a byte boundary.
	Checksum	8-bit checksum.
Configuration Address Frame	11111111	Eight stop bits (high) to separate frames.
	00	Address frame header.
	14 Address Bits	14-bit address of location to start data storage.
	Checksum	8-bit checksum.
Postamble	11111111	Eight stop bits (high) to separate frames.
	00	Postamble header.
	11111111 111111	Dummy address.
	1111111111111111	16 stop bits.

Note: For slave parallel mode, the byte containing the preamble must be 11110010. The number of leading header dummy bits must be $(n * 8) + 4$, where n is any nonnegative integer and the number of trailing dummy bits must be $(n * 8)$, where n is any positive integer. The number of stop bits/frame for slave parallel mode must be $(x * 8)$, where x is a positive integer. Note also that the bit stream generator tool supplies a bit stream that is compatible with all configuration modes, including slave parallel mode.

FPGA Configuration Target Controller Data Format (continued)

The length and number of data frames and information on the PROM size for the OR3TP12 is given in Table 27.

Table 27. Configuration Frame Size

Devices	OR3TP12
Number of Frames	1240
Data Bits/Frame	232
Configuration Data (Number of frames × number of data bits/frame)	287,680
Maximum Total Number Bits/Frame (align bits, 01 frame start, 8-bit checksum, eight stop bits)	256
Maximum Configuration Data (number bits/frame × number of frames)	317,440
Maximum PROM Size (bits) (add configuration header and postamble)	317,608

Bit Stream Error Checking

There are three different types of bit stream error checking performed in the ORCA Series 3+ FPSCs: ID frame, frame alignment, and CRC checking.

The ID data frame is sent to a dedicated location in the FPSC. This ID frame contains a unique code for the device for which it was generated. This device code is compared to the internal code of the FPSC. Any differences are flagged as an ID error. This frame is automatically created by the bit stream generation program in ispLEVER.

Each data and address frame in the FPSC begins with a frame start pair of bits and ends with eight stop bits set to one. If any of the previous stop bits were a 0 when a frame start pair is encountered, it is flagged as a frame alignment error.

Error checking is also done on the FPSC for each frame by means of a checksum byte. If an error is found on evaluation of the checksum byte, then a checksum/parity error is flagged.

When any of the three possible errors occur, the FPSC is forced into an idle state, forcing $\overline{\text{INIT}}$ low. The FPSC will remain in this state until either the $\overline{\text{RESET}}$ or $\overline{\text{PRGM}}$ pins are asserted.

If using either of the MPI modes or the PCI embedded core to configure the FPSC, the specific type of bit stream error is written to one of the MPI registers or a PCI register, respectively, by the FPGA configuration logic. The $\overline{\text{PGRM}}$ bit of the MPI control register or the PCI embedded core can also be used to reset out of the error condition and restart configuration.

FPGA Configuration Modes

There are eight methods for configuring the FPSC. Six of the configuration modes are selected on the M0, M1, and M2 input and are shown in Table 28. The seventh mode is PCI bus configuration as previously discussed, and the eighth configuration mode is accessed through the boundary-scan interface. A fourth input, M3, is used to select the frequency of the internal oscillator, which is the source for CCLK in some configuration modes. The nominal frequencies of the internal oscillator are 1.25 MHz and 10 MHz. The 1.25 MHz frequency is selected when the M3 input is unconnected or driven to a high state.

Note that the Master parallel mode of configuration that is available in the ORCA Series 3 FPGAs is not available in the OR3TP12. This is due to the use of Master parallel configuration pins for the PCI bus interface.

More information on the general FPGA modes of configuration can be found in the ORCA Series 3 data sheet.

Table 28. Configuration Modes

M2	M1	M0	CCLK	Configuration Mode	Data
0	0	0	Output	Master Serial	Serial
0	0	1	Input	Slave Parallel	Parallel
0	1	0	Output	Microprocessor: <i>Motorola* PowerPC</i>	Parallel
0	1	1	Output	Microprocessor: <i>Intel† i960</i>	Parallel
1	0	0		Reserved	
1	0	1	Output	Async Peripheral	Parallel
1	1	0		Reserved	
1	1	1	Input	Slave Serial	Serial

* Motorola is a registered trademark of Motorola, Inc.

† Intel is a registered trademark of Intel Corporation.

Absolute Maximum Ratings

Stresses in excess of the absolute maximum ratings can cause permanent damage to the device. These are absolute stress ratings only. Functional operation of the device is not implied at these or any other conditions in excess of those given in the operations sections of this data sheet. Exposure to absolute maximum ratings for extended periods can adversely affect device reliability.

The ORCA Series 3+ FPSCs include circuitry designed to protect the chips from damaging substrate injection currents and to prevent accumulations of static charge. Nevertheless, conventional precautions should be observed during storage, handling, and use to avoid exposure to excessive electrical stress.

Table 29. Absolute Maximum Ratings

Parameter	Symbol	Min	Max	Unit
Storage Temperature	T _{stg}	-65	150	°C
Supply Voltage with Respect to Ground	V _{DD}	-0.5	7.0	V
Input Signal with Respect to Ground	—	-0.5	V _{DD} + 0.3*	V
Signal Applied to High-impedance Output	—	-0.5	V _{DD} + 0.3*	V
Maximum Package Body Temperature	—	—	220	°C

* For PCI bus signals used for 5 V signaling and FPGA inputs used as 5 V tolerant, the maximum value is 5.8 V.

Recommended Operating Conditions

Table 30. Recommend Operating Conditions

Mode	OR3TP12	
	Temperature Range (Ambient)	Supply Voltage (V _{DD})
Commercial	0 °C to 70 °C	3.0 V to 3.6 V
Industrial	-40 °C to +85 °C	3.0 V to 3.6 V

Note: The maximum recommended junction temperature (T_J) during operation is 125 °C.

Electrical Characteristics

Table 31. Electrical Characteristics

OR3TP12 Commercial: VDD = 3.0 V to 3.6 V, 0 °C < TA < 70 °C; Industrial: VDD = 3.0 V to 3.6 V, -40 °C < TA < +85 °C.

Parameter	Symbol	Test Conditions	OR3TP12		Unit
			Min	Max	
Input Voltage: High Low	V _{IH} V _{IL}	Input configured as CMOS (clamped to VDD)	50% VDD GND - 0.5	VDD + 0.3 30% VDD	V V
Input Voltage: High Low	V _{IH} V _{IL}	Input configured as 5 V tolerant	50% VDD GND - 0.5	5.8 V 30% VDD	V V
Output Voltage: High Low	V _{OH} V _{OL}	VDD = min, I _{OH} = 6 mA or 3 mA VDD = min, I _{OL} = 12 mA or 6 mA	2.4 —	— 0.4	V V
Input Leakage Current	I _L	VDD = max, V _{IN} = VSS or VDD	-10	10	µA
Standby Current	I _{DDSB}	(TA = 25 °C, VDD = 3.3 V) internal oscillator running, no output loads, inputs at VDD or GND (after configuration)	—	5.3	mA
Standby Current	I _{DDSB}	(TA = 25 °C, VDD = 3.3 V) internal oscillator stopped, no output loads, inputs at VDD or GND (after configuration)	—	1.4	mA
Data Retention Voltage	VDR	TA = 25 °C	2.3	—	V
Powerup Current	I _{PP}	Power supply current at approximately 1 V, within a recommended power supply ramp rate of 1 ms—200 ms	2.7	—	mA
Input Capacitance	C _{IN}	(TA = 25 °C, VDD = 3.3 V) test frequency = 1 MHz	—	8	pF
Output Capacitance	C _{OUT}	(TA = 25 °C, VDD = 3.3 V) test frequency = 1 MHz	—	9	pF
DONE Pull-up Resistor*	R _{DONE}	—	100	—	kΩ
M[3:0] Pull-up Resistors*	R _M	—	100	—	kΩ
I/O Pad Static Pull-up Current*	I _{PU}	(VDD = 3.6 V, V _{IN} = VSS, TA = 0 °C)	14.4	50.9	µA
I/O Pad Static Pull-down Current	I _{PD}	(VDD = 3.6 V, V _{IN} = VSS, TA = 0 °C)	26	103	µA
I/O Pad Pull-up Resistor*	R _{PU}	VDD = all, V _{IN} = VSS, TA = 0 °C	100	—	kΩ
I/O Pad Pull-down Resistor	R _{PD}	VDD = all, V _{IN} = VDD, TA = 0 °C	50	—	kΩ

* On the Series 3 devices, the pull-up resistor will externally pull the pin to a level 1.0 V below V_{DD}.

Timing Characteristics

Description

The most accurate timing characteristics are reported by the timing analyzer in the ispLEVER development system. A timing report provided by the development system after layout divides path delays into logic and routing delays. The timing analyzer can also provide logic delays prior to layout. While this allows routing budget estimates, there is wide variance in routing delays associated with different layouts.

The logic timing parameters noted in the Electrical Characteristics section of this data sheet are the same as those in the design tools. In the PFU timing, symbol names are generally a concatenation of the PFU operating mode and the parameter type. The setup, hold, and propagation delay parameters, defined below, are designated in the symbol name by the SET, HLD, and DEL characters, respectively.

The values given for the parameters are the same as those used during production testing and speed binning of the devices. The junction temperature and supply voltage used to characterize the devices are listed in the delay tables. Actual delays at nominal temperature and voltage for best-case processes can be much better than the values given.

It should be noted that the junction temperature used in the tables is generally 85 °C. The junction temperature for the FPGA depends on the power dissipated by the device, the package thermal characteristics (Θ_{JA}), and the ambient temperature, as calculated in the following equation and as discussed further in the Package Thermal Characteristics section:

$$T_{Jmax} = T_{Amax} + (P \cdot \Theta_{JA}) \text{ } ^\circ\text{C}$$

Note: The user must determine this junction temperature to see if the delays from ispLEVER should be derated based on the following derating tables.

Table 32 and Table 33 provide approximate power supply and junction temperature derating for OR3TP12 commercial devices. The delay values in this data sheet and reported by ispLEVER are shown as 1.00 in the tables. The method for determining the maximum junction temperature is defined in the Package Thermal Characteristics section. Taken cumulatively, the range of parameter values for best-case vs worst-case processing, supply voltage, and junction temperature can approach three to one.

Table 32. Derating for Commercial Devices (I/O Supply VDD)

T _J (°C)	Power Supply Voltage		
	3.0 V	3.3 V	3.6 V
-40	0.82	0.72	0.66
0	0.91	0.80	0.72
25	0.98	0.85	0.77
85	1.00	0.99	0.90
100	1.23	1.07	0.94
125	1.34	1.15	1.01

Note: The derating tables shown above are for a typical critical path that contains 33% logic delay and 66% routing delay. Since the routing delay derates at a higher rate than the logic delay, paths with more than 66% routing delay will derate at a higher rate than shown in the table. The approximate derating values vs temperature are 0.26% per °C for logic delay and 0.45% per °C for routing delay. The approximate derating values vs voltage are 0.13% per mV for both logic and routing delays at 25 °C.

Propagation Delay. The time between the specified reference points. The delays provided are the worst case of the t_{phh} and t_{pll} delays for noninverting functions, t_{plh} and t_{phl} for inverting functions, and t_{phz} and t_{plz} for 3-state enable.

Setup Time. The interval immediately preceding the transition of a clock or latch enable signal, during which the data must be stable to ensure it is recognized as the intended value.

Hold Time. The interval immediately following the transition of a clock or latch enable signal, during which the data must be held stable to ensure it is recognized as the intended value.

3-State Enable. The time from when a 3-state control signal becomes active and the output pad reaches the high-impedance state.

Timing Characteristics (continued)

PFU Timing

Refer to *ORCA OR3C/Txxx* Series data sheet for the following:

- Combinational PFU Timing Characteristics
- Sequential PFU Timing Characteristics
- Ripple Mode PFU Timing Characteristics
- Synchronous Memory Write Characteristics
- Synchronous Memory Read Characteristics

PLC Timing

Refer to *ORCA OR3C/Txxx* Series data sheet for the following:

- PFU Output MUX and Direct Routing Timing Characteristics

SLIC Timing

Refer to *ORCA OR3C/Txxx* Series data sheet for the following:

- Supplemental Logic and Interconnect Cell (SLIC) Timing Characteristics

PIO Timing

Refer to *ORCA OR3C/Txxx* Series data sheet for the following:

- Programmable I/O (PIO) Timing Characteristics

Special Function Timing

Refer to *ORCA OR3C/Txxx* Series data sheet for the following:

- Microprocessor Interface (MPI) Timing Characteristics
- Programmable Clock Manager (PCM) Timing Characteristics
- Boundary-Scan Timing Characteristics

Clock Timing

Refer to *ORCA OR3C/Txxx* Series data sheet for the following:

- ExpressCLK (ECLK) and Fast Clock (FCLK) Timing Characteristics
- General-Purpose Clock Timing Characteristics (Internally Generated Clock)
- OR3TP12 ExpressCLK to Output Delay (Pin-to-Pin)
- OR3TP12 Fast Clock (FCLK) to Output Delay (Pin-to-Pin)
- OR3TP12 General System Clock (SCLK) to Output Delay (Pin-to-Pin)
- OR3TP12 Input to ExpressCLK (ECLK) Fast Capture Set-Up/Hold Time (Pin-to-Pin)
- OR3TP12 Input to Fast Clock Setup/Hold Time (Pin-to-Pin)
- OR3TP12 Input to General System Clock Setup/Hold Time (Pin-to-Pin)

Configuration Timing

Refer to *ORCA OR3C/Txxx* Series data sheet for the following:

- General Configuration Mode Timing Characteristics
- Master Serial Configuration Mode Timing Characteristics
- Asynchronous Peripheral Configuration Mode Timing Characteristics
- Slave Serial Configuration Mode Timing Characteristics
- Microprocessor Interface Timing Characteristics

Readback Timing

Refer to *ORCA OR3C/Txxx* Series data sheet for the following:

- Readback Timing Characteristics

Timing Characteristics (continued)

Table 33. OR3TP12 PCI and FPGA Interface Clock Operation Frequencies

OR3TP12 Commercial: VDD = 3.0 V to 3.6 V, 0 °C < TA < 70 °C.

Description (TI = 85 °C, VDD = min, VDD2 = min)	Speed -7			Unit
	Min	Typ	Max	
Clk (PCI clock)	0	—*	66*	MHz
fclk1 (user interface clock)	0	—†	66‡	MHz
fclk2 (user interface clock)	0	—†	66‡	MHz

* The PCI clock frequency is based on the internal register to register frequency and the 66 MHz PCI I/O specifications.

† The Maximum User Interface Clock frequencies are values based on registering all signals at the FPGA/ASIC boundary. This number will be lower depending on the design implementation and number of FPGA logic levels into and out of the ASIC.

‡ This is the typical operating frequency for a real design that does not register signals at the FPGA/ASIC boundary.

Table 34. OR3TP12 FPGA to PCI, and PCI to FPGA, Combinatorial Path Delays

OR3TP12 Commercial: VDD = 3.0 V to 3.6 V, 0 °C < TA < 70 °C.

Description (TI = 85 °C, VDD = min, VDD2 = min)		Min	Max	Unit
Source	Destination			
pci_intan (FPGA Side)	intan (PCI Side)	—	4.601	ns
clk (PCI Side)	pciclk (FPGA Side)	—	4.544	ns
rstn (PCI Side)	pci_rstn (FPGA Side)	—	2.442	ns

Notes:

On the FPGA to PCI combinatorial path delays, they include the ASIC path delay and the output buffer delay under a 10pf load. They do not include the interbuf delay on the FPGA side.

On the PCI to FPGA combinatorial path delays, they include the ASIC input buffer delay, and ASIC path delay entering the FPGA. They do not include the interbuf delay on the FPGA side.

Timing Characteristics (continued)

Table 35. OR3TP12 FPGA Side Interface Combinatorial Path Delay Signals

OR3TP12 Commercial: VDD = 3.0 V to 3.6 V, 0 °C < TA < 70 °C.

Description (Ti = 85 °C, VDD = min, VDD2 = min)		Min	Max	Unit
Source	Destination			
fifo_sel	datatofpga[31:0]	—	2.364	ns
fifo_sel	datatofpgax[3:0]	—	1.999	ns
twdataenn	twlastcycn	—	6.565	ns
twdataenn	datatofpga[31:0] (dual-port mode)	—	8.968	ns
twdataenn	datatofpgax[3:0] (dual-port mode)	—	7.929	ns
twdataenn	twdata[17:0] (quad-port mode)	—	7.687	ns
trdataenn	trlastcycn	—	5.457	ns
mrdataenn	mrlastcycn	—	5.899	ns
taenn	twlastcycn	—	6.530	ns
taenn	datatofpga[31:0] (dual-port mode)	—	9.278	ns
taenn	datatofpgax[3:0] (dual-port mode)	—	7.904	ns
taenn	twdata[17:0] (quad-port mode)	—	7.696	ns
cfgshiftenn	pci_cfg_stat	—	6.202	ns
mrdataenn	datatofpga[31:0]	—	7.516	ns
mrdataenn	mrdata[17:0]	—	7.340	ns

Note: The combinatorial path parameters are measured from the input to the output (both on the FPGA side), excluding the interbufs, which traverse the ASIC/FPGA boundary. The ispLEVER static analysis tool, trace, accounts for clock skew and interbuf delays on the clock and data paths.

Table 36. OR3TP12 Interbuf Delays

OR3TP12 Commercial: VDD = 3.0 V to 3.6 V, 0 °C < TA < 70 °C.

Description (Ti = 85 °C, VDD = min, VDD2 = min)	Min	Max	Unit
Interbuf from FPGA to ASIC	—	0.696	ns
Interbuf from ASIC to FPGA	—	0.505	ns

Note: The interbufs are buffers that interface between the FPGA and the ASIC.

Timing Characteristics (continued)

Table 37. OR3TP12 FPGA Side Interface Clock to Output Delays, pciclk Synchronous Signals

OR3TP12 Commercial: VDD = 3.0 V to 3.6 V, 0 °C < TA < 70 °C.

Description (TI = 85 °C, VDD = min, VDD2 = min)	Min	Max	Unit
tcmd[3:0]	—	5.124	ns
bar[2:0]	—	4.586	ns
pci_cfg_stat	—	11.383	ns

Note: The clock to out parameters are measured from the **pciclk** clock output pin on the FPGA side, excluding the interbufs, which traverse the ASIC/FPGA boundary. The ispLEVER static analysis tool, trace, accounts for clock skew and interbuf delays on the clock and data paths.

Table 38. OR3TP12 FPGA Side Interface Clock to Output Delays, fclk Synchronous Signals

OR3TP12 Commercial: VDD = 3.0 V to 3.6 V, 0 °C < TA < 70 °C.

Description (TI = 85 °C, VDD = min, VDD2 = min)	Min	Max	Unit
fpga_msyserror	—	3.468	ns
ma_fulln	—	4.230	ns
mstatecncr[3:0]	—	5.049	ns
m_ready	—	4.996	ns
mw_fulln	—	4.918	ns
mw_fulln	—	4.056	ns
datatofpga[31:0] (dual-port mode)	—	12.514	ns
datatofpgax[3:0] (dual-port mode)	—	11.347	ns
mrdata[17:0] (quad-port mode)	—	12.514	ns
twdata[17:0] (quad-port mode)	—	11.229	ns
mr_emptyn	—	4.302	ns
mr_aemptyn	—	4.169	ns
mrlastcycn	—	8.835	ns
disctimerexpn	—	3.673	ns
treqn	—	5.643	ns
t_ready	—	4.779	ns
tstatecncr[3:0]	—	5.716	ns
tw_emptyn	—	4.741	ns
tw_aemptyn	—	4.360	ns
twlastcycn	—	10.212	ns
tr_fulln	—	4.554	ns
tr_fulln	—	4.216	ns
trlastcycn	—	6.154	ns

Note: The clock to out parameters are measured from the **fclk1** and **fclk2** clock input pins on the FPGA side, excluding the interbufs, which traverse the ASIC/FPGA boundary. The ispLEVER static analysis tool, trace, accounts for clock skew and interbuf delays on the clock and data paths.

Timing Characteristics (continued)

Table 39. OR3TP12 FPGA Side Interface Input Setup Delays, **pcclk** Synchronous Signals

OR3TP12 Commercial: VDD = 3.0 V to 3.6 V, 0 °C < TA < 70 °C.

Description (TI = 85 °C, VDD = min, VDD2 = min)	Min	Max	Unit
fpga_mbusyn	0	—	ns
deltrn	0	—	ns
mwpcihold	3.943	—	ns
mr_mstopburstn	0	—	ns
t_abort	1.197	—	ns
t_retrn	0.795	—	ns
twburstpendn	0	—	ns
trpcihold	0.693	—	ns
trburstpendn	0	—	ns
fpga_syserror	0	—	ns
cfgshiftenn	0	—	ns

Note: The input setup parameters are measured from the **pcclk** clock output pin on the FPGA side, excluding the interbufs, which traverse the ASIC/FPGA boundary. The ispLEVER static analysis tool, trace, accounts for clock skew and interbuf delays on the clock and data paths.

Table 40. OR3TP12 FPGA Side Interface Input Setup Delays, **fclk** Synchronous Signals

OR3TP12 Commercial: VDD = 3.0 V to 3.6 V, 0 °C < TA < 70 °C.

Description (TI = 85 °C, VDD = min, VDD2 = min)	Min	Max	Unit
maenn	6.426	—	ns
mwdataenn	6.452	—	ns
datafmfpga[31:0] (dual-port mode)	7.344	—	ns
datafmfpgax[3:0] (dual-port mode)	5.226	—	ns
mwdata[17:0] (quad-port mode)	7.205	—	ns
trdata[17:0] (quad-port mode)	7.344	—	ns
mwlastcycn	6.680	—	ns
mrdataenn	5.371	—	ns
taenn	5.048	—	ns
twdataenn	5.099	—	ns
trdataenn	5.919	—	ns

Note: The input setup parameters are measured from the **fclk1** and **fclk2** clock input pins on the FPGA side, excluding the interbufs, which traverse the ASIC/FPGA boundary. The ispLEVER static analysis tool, trace, accounts for clock skew and interbuf delays on the clock and data paths.

Input/Output Buffer Measurement Conditions

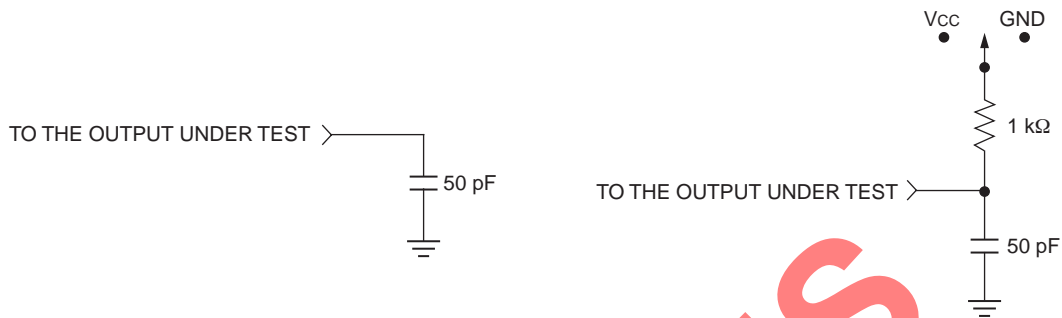

A. Load Used to Measure Propagation Delay

B. Load Used to Measure Rising/Falling Edges

5-3234(F)

Note: Switch to V_{DD} for T_{PLZ}/T_{PZL}; switch to GND for T_{PHZ}/T_{PZH}.

Figure 37. ac Test Loads

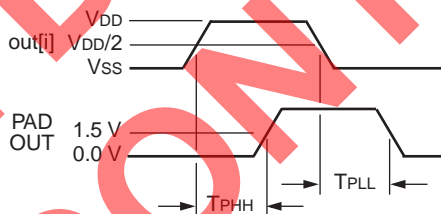

5-3233.a(F)

Figure 38. Output Buffer Delays

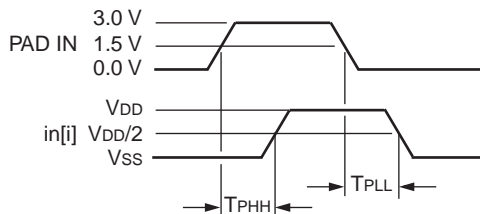
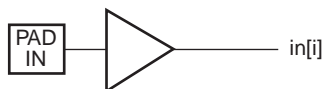

5-3235(F)

Figure 39. Input Buffer Delays

Output Buffer Characteristics

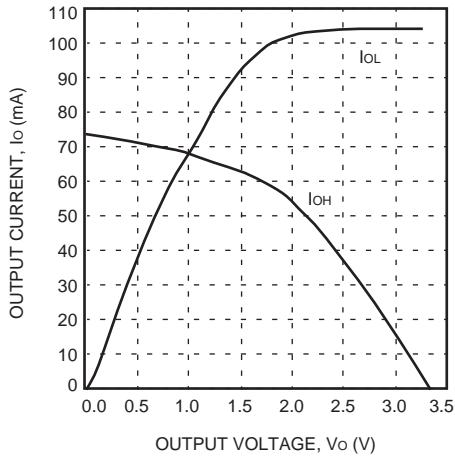

5-6865(F)

Figure 40. Sinklim ($T_J = 25\text{ }^\circ\text{C}$, $V_{DD} = 3.3\text{ V}$)

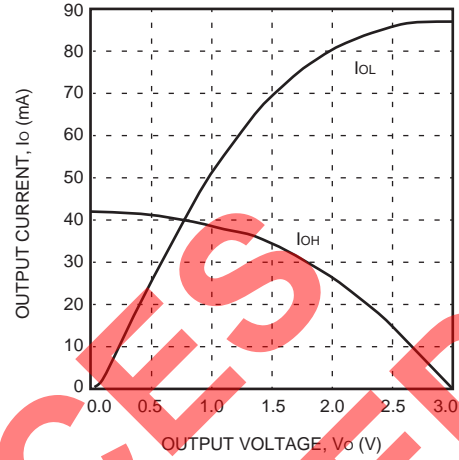

5-6866(F)

Figure 43. Sinklim ($T_J = 125\text{ }^\circ\text{C}$, $V_{DD} = 3.0\text{ V}$)

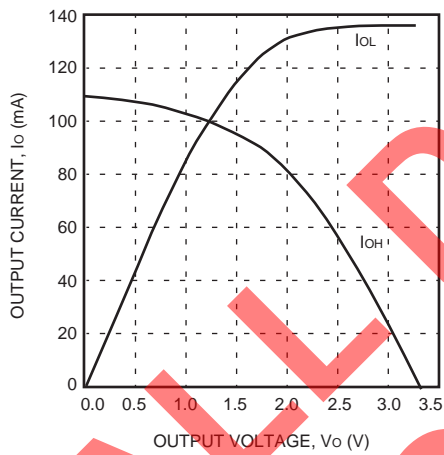

5-6867(F)

Figure 41. Slewlim ($T_J = 25\text{ }^\circ\text{C}$, $V_{DD} = 3.3\text{ V}$)

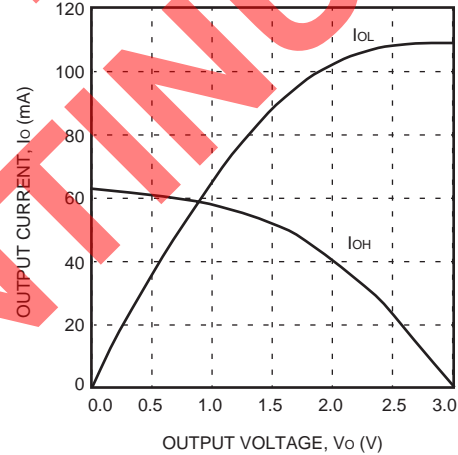

5-6868(F)

Figure 44. Slewlim ($T_J = 125\text{ }^\circ\text{C}$, $V_{DD} = 3.0\text{ V}$)

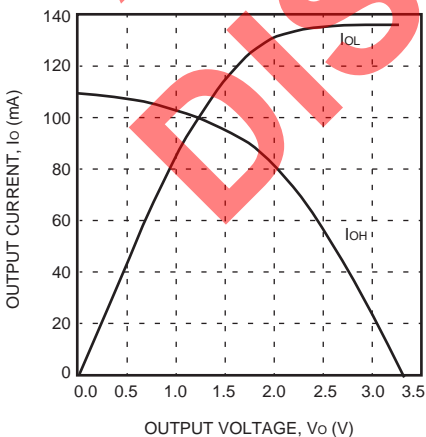

5-6867(F)

Figure 42. Fast ($T_J = 25\text{ }^\circ\text{C}$, $V_{DD} = 3.3\text{ V}$)

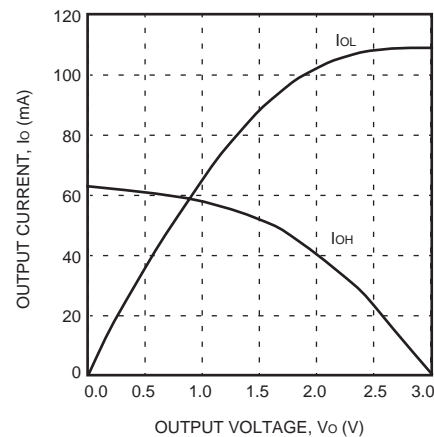

5-6868(F)

Figure 45. Fast ($T_J = 125\text{ }^\circ\text{C}$, $V_{DD} = 3.0\text{ V}$)

Estimating Power Dissipation

The total power dissipated by the OR3TP12 is the combined power dissipated by the PCI bus core and FPGA array. The maximum power dissipated will not exceed that of its base array the OR3T55 FPGA. The maximum power used by the PCI bus core will be 890 mW at 66 MHz, 3.6 V and 85 °C. General FPGA power estimation parameters can be found in the *ORCA Series 3* data sheet.

ALL DEVICES
DISCONTINUED

Pin Information

This section describes the pins and signals that perform FPGA-related functions. Any pins not described in Table 5 or here in Table 41 are user-programmable I/Os. During configuration, the user-programmable I/Os are 3-stated and pulled-up with an internal resistor. If any FPGA function pin is not used (or not bonded to package pin), it is also 3-stated and pulled-up after configuration.

Table 41. FPGA Common-Function Pin Descriptions

Symbol	I/O	Description
Dedicated Pins		
VDD	—	Positive power supply.
GND	—	Ground supply.
RESET	I	During configuration, RESET forces the restart of configuration and a pull-up is enabled. After configuration, RESET can be used as an FPGA logic direct input, which causes all PLC latches/FFs to be asynchronously set/reset.
CCLK	I	In the Master and asynchronous peripheral modes, CCLK is an output which strobes configuration data in. In the slave or synchronous peripheral mode, CCLK is input synchronous with the data on DIN or D[7:0]. In microprocessor and PCI modes, CCLK is used internally and output for daisy-chain operation.
DONE	I O	As an input, a low level on DONE delays FPGA start-up after configuration.* As an active-high, open-drain output, a high level on this signal indicates that configuration is complete. DONE is also used in the embedded PCI core start-up sequence. DONE has an optional pull-up resistor.
PRGM	I	PRGM is an active-low input that forces the restart of configuration and resets the boundary-scan circuitry. This pin always has an active pull-up.
RD_CFG	I	This pin must be held high during device initialization until the INIT pin goes high. This pin always has an active pull-up. During configuration, RD_CFG is an active-low input that activates the TS_ALL function and 3-states all of the I/O. After configuration, RD_CFG can be selected (via a bit stream option) to activate the TS_ALL function as described above, or, if readback is enabled via a bit stream option, a high-to-low transition on RD_CFG will initiate readback of the configuration data, including PFU output states, starting with frame address 0.
RD_DATA/TDO	O	RD_DATA/TDO is a dual-function pin. If used for readback, RD_DATA provides configuration data out. If used in boundary scan, TDO is test data out.
Special-Purpose Pins		
M0, M1, M2	I I/O	During powerup and initialization, M0—M2 are used to select the configuration mode with their values latched on the rising edge of INIT; see Table 28 for the configuration modes. During configuration, a pull-up is enabled. After configuration, M2 can be a user-programmable I/O.*
M3	I I/O	During powerup and initialization, M3 is used to select the speed of the internal oscillator during configuration with their values latched on the rising edge of INIT. When M3 is low, the oscillator frequency is 10 MHz. When M3 is high, the oscillator is 1.25 MHz. During configuration, a pull-up is enabled. After configuration, M2 can be a user-programmable I/O pin.*

* The ORCA Series 3 FPGA data sheet contains more information on how to control these signals during start-up. The timing of DONE release is controlled by one set of bit stream options, and the timing of the simultaneous release of all other configuration pins (and the activation of all user I/Os) is controlled by a second set of options.

Pin Information (continued)

Table 41. FPGA Common-Function Pin Descriptions (continued)

Symbol	I/O	Description
Special-Purpose Pins (continued)		
TDI, TCK, TMS	I I/O	If boundary scan is used, these pins are test data in, test clock, and test mode select inputs. If boundary scan is not selected, all boundary-scan functions are inhibited once configuration is complete. Even if boundary scan is not used, either TCK or TMS must be held at logic one during configuration. Each pin has a pull-up enabled during configuration. After configuration, these pins are user-programmable I/O.*
RDY/RCLK/ MPI_ALE	O O I I/O	During configuration in peripheral mode, RDY/RCLK indicates another byte can be written to the FPGA. If a read operation is done when the device is selected, the same status is also available on D7 in asynchronous peripheral mode. During the Master parallel configuration mode, RCLK is a read output signal to an external memory. This output is not normally used. In i960 microprocessor mode, this pin acts as the address latch enable (ALE) input. After configuration, if the MPI is not used, this pin is a user-programmable I/O pin.*
HDC	O	High during configuration is output high until configuration is complete. It is used as a control output indicating that configuration is not complete.
$\overline{\text{LDC}}$	O	Low during configuration is output low until configuration is complete. It is used as a control output indicating that configuration is not complete.
$\overline{\text{INIT}}$	I/O	$\overline{\text{INIT}}$ is a bidirectional signal before and during configuration. During configuration, a pull-up is enabled, but an external pull-up resistor is recommended. As an active-low open-drain output, $\overline{\text{INIT}}$ is held low during power stabilization and internal clearing of memory. As an active-low input, $\overline{\text{INIT}}$ holds the FPGA in the wait-state before the start of configuration.
$\overline{\text{CS0}}$, CS1	I I/O	$\overline{\text{CS0}}$ and CS1 are used in the asynchronous peripheral, slave parallel, and microprocessor configuration modes. The FPGA is selected when $\overline{\text{CS0}}$ is low and CS1 is high. During configuration, a pull-up is enabled. After configuration, these pins are user-programmable I/O pins.*
$\overline{\text{RD}}$ /MPI_STRB	I I I/O	$\overline{\text{RD}}$ is used in the asynchronous peripheral configuration mode. A low on $\overline{\text{RD}}$ changes D7 into a status output. As a status indication, a high indicates ready, and a low indicates busy. $\overline{\text{WR}}$ and $\overline{\text{RD}}$ should not be used simultaneously. If they are, the write strobe overrides. This pin is also used as the microprocessor interface (MPI) data transfer strobe. For PowerPC, it is the transfer start (TS). For i960, it is the address/data strobe (ads). After configuration, if the MPI is not used, this pin is a user-programmable I/O pin.*
$\overline{\text{WR}}$	I I/O	$\overline{\text{WR}}$ is used in the asynchronous peripheral configuration mode. When the FPGA is selected, a low on the write strobe, $\overline{\text{WR}}$, loads the data on D[7:0] inputs into an internal data buffer. $\overline{\text{WR}}$ and $\overline{\text{RD}}$ should not be used simultaneously. If they are, the write strobe overrides. After configuration, this pin is a user-programmable I/O pin.*

* The ORCA Series 3 FPGA data sheet contains more information on how to control these signals during start-up. The timing of DONE release is controlled by one set of bit stream options, and the timing of the simultaneous release of all other configuration pins (and the activation of all user I/Os) is controlled by a second set of options.

Pin Information (continued)

Table 41. FPGA Common-Function Pin Descriptions (continued)

Symbol	I/O	Description
Special-Purpose Pins (continued)		
$\overline{\text{MPI_IRQ}}$	O I/O	MPI active-low interrupt request output. If the MPI is not in use, this is a user-programmable I/O.
$\overline{\text{MPI_BI}}$	O I/O	<i>PowerPC</i> mode MPI burst inhibit output. If the MPI is not in use, this is a user-programmable I/O.
$\overline{\text{MPI_ACK}}$	O	In <i>PowerPC</i> mode MPI operation, this is the active-high transfer acknowledge ($\overline{\text{TA}}$) output. For <i>i960</i> MPI operation, it is the active-low ready/record ($\overline{\text{RDYRCV}}$) output. If the MPI is not in use, this is a user-programmable I/O.
MPI_RW	I I/O	In <i>PowerPC</i> mode MPI operation, this is the active-low write/ active-high read control signals. For <i>i960</i> operation, it is the active-high write/active-low read control signal. If the MPI is not in use, this is a user-programmable I/O.
MPI_CLK	I I/O	This is the clock used for the synchronous MPI interface. For <i>PowerPC</i> , it is the CLK-OUT signal. For <i>i960</i> , it is the system clock that is chosen for the <i>i960</i> external bus interface. If the MPI is not in use, this is a user-programmable I/O.
$\text{A}[4:0]$	I I/O	For <i>PowerPC</i> operation, these are the <i>PowerPC</i> address inputs. The address bit mapping (in <i>PowerPC/FPGA</i> notation) is $\text{A}[31]/\text{A}[0]$, $\text{A}[30]/\text{A}[1]$, $\text{A}[29]/\text{A}[2]$, $\text{A}[28]/\text{A}[3]$, $\text{A}[27]/\text{A}[4]$. Note that $\text{A}[27]/\text{A}[4]$ is the MSB of the address. The $\text{A}[4:2]$ inputs are not used in <i>i960</i> MPI mode. If the MPI is not in use, this is a user-programmable I/O.
$\text{A}[1:0]/\overline{\text{MPI_BE}}[1:0]$	I	For <i>i960</i> operation, $\overline{\text{MPI_BE}}[1:0]$ provide the <i>i960</i> byte enable signals, $\overline{\text{be}}[1:0]$, that are used as address bits $\text{A}[1:0]$ in <i>i960</i> byte-wide operation.
$\text{D}[7:0]$	I I/O	During Master parallel, peripheral, and slave parallel configuration modes, $\text{D}[7:0]$ receive configuration data, and each pin has a pull-up enabled. During serial configuration modes, D_0 is the DIN input. $\text{D}[7:0]$ are also the data pins for <i>PowerPC</i> microprocessor mode and the address/data pins for <i>i960</i> microprocessor mode. After configuration, the pins are user-programmable I/O pins.*
DIN	I I/O	During slave serial or Master serial configuration modes, DIN accepts serial configuration data synchronous with CCLK. During parallel configuration modes, DIN is the D_0 input. During configuration, a pull-up is enabled. After configuration, this pin is a user-programmable I/O pin.*
DOUT	O I/O	During configuration, DOUT is the serial data output that can drive the DIN of daisy-chained slave LCA devices. Data out on DOUT changes on the falling edge of CCLK. After configuration, DOUT is a user-programmable I/O pin.*

* The ORCA Series 3 FPGA data sheet contains more information on how to control these signals during start-up. The timing of DONE release is controlled by one set of bit stream options, and the timing of the simultaneous release of all other configuration pins (and the activation of all user I/Os) is controlled by a second set of options.

Pin Information (continued)

Table 42. OR3TP12 256-Pin PBGA Pinout

Pin	OR3TP12	Function	Pin	OR3TP12	Function
B1	VDD	VDD	N2	PL11A	I/O-A10/MPI_B \bar{I}
C2	PL1D	I/O	N3	PL12D	I/O
D2	PL1C	I/O	P1	PL12C	I/O
D3	PL1B	I/O	P2	PL12B	I/O
E4	PL2D	I/O-A0/MPI_BE $\bar{0}$	R1	PL12A	I/O-A11/MPI-IRQ
C1	PL2C	I/O	P3	PL13D	I/O-A12
D1	PL2B	I/O	R2	PL13B	I/O-SECKLL
E3	PL2A	I/O	T1	PL14D	I/O
E2	PL3D	I/O	P4	PL14B	I/O-A13
E1	PL3A	I/O	R3	PL14A	I/O
F3	PL4D	I/O	T2	PL15D	gntn (PCI)
G4	PL4A	I/O-A1/MPI_BE $\bar{1}$	U1	PL15B	reqn (PCI)
F2	PL5D	I/O	T3	PL16D	ad31 (PCI)
F1	PL5A	I/O-A2	U2	PL17D	NC
G3	PL6D	I/O	V1	PL17C	NC
G2	PL6B	I/O	T4	PL17B	NC
G1	PL6A	I/O-A3	U3	PL17A	ad30 (PCI)
H3	PL7D	I/O	V2	PL18D	NC
H2	PL7C	I/O	W1	PL18C	ad29 (PCI)
H1	PL7B	I/O	V3	PL18B	NC
J4	PL7A	I/O-A4	W2	PL18A	ad28 (PCI)
J3	PL8D	I/O-A5	Y1	CCLK	CCLK
J2	PL8C	I/O	W3	—	NC
J1	PL8B	I/O	Y2	PB1A	rstn (PCI)
K2	PL8A	I/O-A6	W4	PB1C	NC
K3	PECKL	I-ECKL	V4	PB1D	intan (PCI)
K1	PL9C	I/O	U5	PB2A	vio (PCI)
L1	PL9B	I/O	Y3	PB2B	NC
L2	PL9A	I/O-A7/MPI_CLK	Y4	PB2C	NC
L3	PL10D	I/O	V5	PB2D	ad27 (PCI)
L4	PL10C	I/O	W5	PB3D	ad26 (PCI)
M1	PL10B	I/O	Y5	PB4D	ad25 (PCI)
M2	PL10A	I/O-A8/MPI_RW	V6	PB5A	ad24 (PCI)
M3	PL11D	I/O-A9/MPI_ACK	U7	PB5B	idsel (PCI)
M4	PL11C	I/O	W6	PB5D	ad23 (PCI)
N1	PL11B	I/O	Y6	PB6A	ad22 (PCI)

Pin Information (continued)

Table 43. OR3TP12 256-Pin PBGA Pinout (continued)

Pin	OR3TP12	Function	Pin	OR3TP12	Function
V7	PB6B	ad21 (PCI)	W17	PB16D	ad8 (PCI)
W7	PB6D	ad20 (PCI)	Y18	PB17A	ad7 (PCI)
Y7	PB7A	ad19 (PCI)	U16	PB17C	NC
V8	PB7B	ad18 (PCI)	V17	PB17D	ad6 (PCI)
W8	PB7C	ad17 (PCI)	W18	PB18A	ad5 (PCI)
Y8	PB7D	ad16 (PCI)	Y19	PB18B	NC
U9	PB8A	c_ben3 (PCI)	V18	PB18C	NC
V9	PB8B	c_ben2 (PCI)	W19	PB18D	ad4 (PCI)
W9	PB8C	trdyn (PCI)	Y20	DONE	DONE
Y9	PB8D	NC	W20	RESETN	RESET
W10	PB9A	NC	V19	PRGMN	PRGM
V10	PB9B	irdyn (PCI)	U19	PR18A	M0
Y10	PB9C	devseln (PCI)	U18	PR18C	enumn (PCI)
Y11	PB9D	stopn (PCI)	T17	PR18D	ledn (PCI)
W11	PECKB	clk (PCI)	V20	PR17A	NC
V11	PB10B	framen (PCI)	U20	PR17B	ad3 (PCI)
U11	PB10C	perrn (PCI)	T18	PR17C	NC
Y12	PB10D	serrn (PCI)	T19	PR17D	NC
W12	PB11A	NC	T20	PR16A	ad2 (PCI)
V12	PB11B	par (PCI)	R18	PR16D	ad1 (PCI)
U12	PB11C	c_ben1 (PCI)	P17	PR15A	ad0 (PCI)
Y13	PB11D	c_ben0 (PCI)	R19	PR15C	ejectsw (PCI)
W13	PB12A	HDC	R20	PR15D	M1
V13	PB12B	ad15 (PCI)	P18	PR14A	I/O
Y14	PB12C	ad14 (PCI)	P19	PR14D	I/O
W14	PB12D	ad13 (PCI)	P20	PR13A	I/O
Y15	PB13A	LDC	N18	PR12A	I/O-M2
V14	PB13B	NC	N19	PR12B	I/O
W15	PB13C	NC	N20	PR12C	I/O
Y16	PB13D	ad12 (PCI)	M17	PR12D	I/O
U14	PB14A	ad11 (PCI)	M18	PR11A	I/O-M3
V15	PB14D	ad10 (PCI)	M19	PR11B	I/O
W16	PB15A	INIT	M20	PR11C	I/O
Y17	PB15D	ad9 (PCI)	L19	PR11D	I/O
V16	PB16A	NC	L18	PR10A	I/O

Pin Information (continued)

Table 43. OR3TP12 256-Pin PBGA Pinout (continued)

Pin	OR3TP12	Function	Pin	OR3TP12	Function
L20	PR10B	I/O	B17	PT18B	I/O
K20	PR10C	I/O	C17	PT18A	I/O
K19	PR10D	I/O	D16	PT17D	I/O-RDY/RCLK/MPI_ALE
K18	PECKR	I-ECKR	A18	PT17A	I/O
K17	PR9B	I/O	A17	PT16D	I/O
J20	PR9C	I/O	C16	PT16C	I/O
J19	PR9D	I/O	B16	PT16A	I/O
J18	PR8A	I/O	A16	PT15D	I/O-D7
J17	PR8B	I/O	C15	PT15A	I/O
H20	PR8C	I/O	D14	PT14D	I/O
H19	PR8D	I/O	B15	PT14A	I/O
H18	PR7A	I/O-CS1	A15	PT13D	I/O
G20	PR7B	I/O	C14	PT13B	I/O-D6
G19	PR7C	I/O	B14	PT13A	I/O
F20	PR7D	I/O	A14	PT12D	I/O
G18	PR6A	I/O-CS0	C13	PT12C	I/O
F19	PR6B	I/O	B13	PT12B	I/O
E20	PR5B	I/O	A13	PT12A	I/O-D5
G17	PR5D	I/O	D12	PT11D	I/O
F18	PR4A	I/O-RD/MPI_STRB	C12	PT11C	I/O
E19	PR4B	I/O	B12	PT11B	I/O
D20	PR4D	I/O	A12	PT11A	I/O-D4
E18	PR3A	I/O	B11	PECKT	I-ECKT
D19	PR2A	I/O-WR	C11	PT10C	I/O
C20	PR2B	I/O	A11	PT10B	I/O
E17	PR2C	I/O	A10	PT10A	I/O-D3
D18	PR2D	I/O	B10	PT9D	I/O
C19	PR1A	I/O	C10	PT9C	I/O
B20	PR1B	I/O	D10	PT9B	I/O
C18	PR1C	I/O	A9	PT9A	I/O-D2
B19	PR1D	I/O	B9	PT8D	I/O-D1
A20	RD_CFGN	RD_CFG	C9	PT8C	I/O
A19	PT18D	I/O-SECKUR	D9	PT8B	I/O
B18	PT18C	I/O	A8	PT8A	I/O-D0/DIN

Pin Information (continued)

Table 42. OR3TP12 256-Pin PBGA Pinout (continued)

Pin	OR3TP12	Function	Pin	OR3TP12	Function
B8	PT7D	I/O	U8	Vss	Vss
C8	PT7C	I/O	U13	Vss	Vss
A7	PT7B	I/O	U17	Vss	Vss
B7	PT7A	I/O-DOUT	J9	Vss	Vss
A6	PT6D	I/O	J10	Vss	Vss
C7	PT6A	I/O	J11	Vss	Vss
B6	PT5C	I/O	J12	Vss	Vss
A5	PT5A	I/O-TDI	K9	Vss	Vss
D7	PT4D	I/O	K10	Vss	Vss
C6	PT4A	I/O	K11	Vss	Vss
B5	PT3D	I/O	K12	Vss	Vss
A4	PT3A	I/O-TMS	L9	Vss	Vss
C5	PT2D	I/O	L10	Vss	Vss
B4	PT2C	I/O	L11	Vss	Vss
A3	PT2B	I/O	L12	Vss	Vss
D5	PT2A	I/O	M9	Vss	Vss
C4	PT1D	I/O	M10	Vss	Vss
B3	PT1C	I/O	M11	Vss	Vss
B2	PT1B	I/O	M12	Vss	Vss
A2	PT1A	I/O-TCK	D6	VDD	VDD
C3	RD_DATA	RD_DATA/TDO	D11	VDD	VDD
A1	Vss	Vss	D15	VDD	VDD
D4	Vss	Vss	F4	VDD	VDD
D8	Vss	Vss	F17	VDD	VDD
D13	Vss	Vss	K4	VDD	VDD
D17	Vss	Vss	L17	VDD	VDD
H4	Vss	Vss	R4	VDD	VDD
H17	Vss	Vss	R17	VDD	VDD
N4	Vss	Vss	U6	VDD	VDD
N17	Vss	Vss	U10	VDD	VDD
U4	Vss	Vss	U15	VDD	VDD

Pin Information (continued)

Table 43. OR3TP12 352-Pin PBGA Pinout

Pin	OR3TP12	Function	Pin	OR3TP12	Function
B1	PL1D	I/O	P2	PL10D	I/O
C2	PL1C	I/O	P4	PL10C	I/O
C1	PL1B	I/O	P1	PL10B	I/O
D2	PL1A	I/O	N3	PL10A	I/O-A8/MPI_RW
D3	PL2D	I/O-A0/MPI_BE $\bar{0}$	R2	PL11D	I/O-A9/MPI_ACK
D1	PL2C	I/O	P3	PL11C	I/O
E2	PL2B	I/O	R1	PL11B	I/O
E4	—	NC	T2	PL11A	I/O-A10/MPI_B
E3	PL2A	I/O	R3	PL12D	I/O
E1	PL3D	I/O	T1	PL12C	I/O
F2	PL3C	I/O	R4	PL12B	I/O
G4	PL3B	I/O	U2	PL12A	I/O-A11/MPI_IRQ
F3	PL3A	I/O	T3	PL13D	I/O-A12
F1	PL4D	I/O	U1	PL13C	I/O
G2	PL4C	I/O	U4	PL13B	I/O-SECKLL
G1	PL4B	I/O	V2	PL13A	I/O
G3	PL4A	I/O-A1/MPI_BE $\bar{1}$	U3	PL14D	I/O
H2	PL5D	I/O	V1	PL14C	I/O
J4	PL5C	I/O	W2	PL14B	I/O-A13
H1	PL5B	I/O	W1	PL14A	I/O
H3	PL5A	I/O-A2	V3	PL15D	gntn (PCI)
J2	PL6D	I/O	Y2	PL15C	c_ben7 (PCI)
J1	PL6C	I/O	W4	PL15B	reqn (PCI)
K2	PL6B	I/O	Y1	PL15A	c_ben6 (PCI)
J3	PL6A	I/O-A3	W3	PL16D	ad31 (PCI)
K1	PL7D	I/O	AA2	PL16C	c_ben5 (PCI)
K4	PL7C	I/O	Y4	PL16B	c_ben4 (PCI)
L2	PL7B	I/O	AA1	PL16A	NC
K3	PL7A	I/O-A4	Y3	PL17D	NC
L1	PL8D	I/O-A5	AB2	PL17C	NC
M2	PL8C	I/O	AB1	PL17B	NC
M1	PL8B	I/O	AA3	PL17A	ad30 (PCI)
L3	PL8A	I/O-A6	AC2	PL18D	ad63 (PCI)
N2	PECKL	I-ECKL	AB4	PL18C	ad29 (PCI)
M4	PL9C	I/O	AC1	PL18B	ad62 (PCI)
N1	PL9B	I/O	AB3	—	NC
M3	PL9A	I/O-A7/MPI_CLK	AD2	—	NC

Pin Information (continued)

Table 43. OR3TP12 352-Pin PBGA Pinout (continued)

Pin	OR3TP12	Function	Pin	OR3TP12	Function
AC3	PL18A	ad28 (PCI)	AC12	PB9B	irdyn (PCI)
AD1	CCLK	CCLK	AF13	PB9C	devseln (PCI)
AF2	PB1A	rstn (PCI)	AD12	PB9D	stopn (PCI)
AE3	—	NC	AE14	PECKB	clk (PCI)
AF3	PB1B	ad61 (PCI)	AC14	PB10B	framen (PCI)
AE4	PB1C	ad60 (PCI)	AF14	PB10C	perrn (PCI)
AD4	PB1D	intan (PCI)	AD13	PB10D	serrn (PCI)
AF4	PB2A	vio (PCI)	AE15	PB11A	NC
AE5	PB2B	ad59 (PCI)	AD14	PB11B	par (PCI)
AC5	PB2C	ad58 (PCI)	AF15	PB11C	c_ben1 (PCI)
AD5	PB2D	ad27 (PCI)	AE16	PB11D	c_ben0 (PCI)
AF5	PB3A	ad57 (PCI)	AD15	PB12A	HDC
AE6	PB3B	ad56 (PCI)	AF16	PB12B	ad15 (PCI)
AC7	PB3C	ad55 (PCI)	AC15	PB12C	ad14 (PCI)
AD6	PB3D	ad26 (PCI)	AE17	PB12D	ad13 (PCI)
AF6	PB4A	ad54 (PCI)	AD16	PB13A	LDC
AE7	PB4B	ad53 (PCI)	AF17	PB13B	ad49 (PCI)
AF7	PB4C	ad52 (PCI)	AC17	PB13C	ad48 (PCI)
AD7	PB4D	ad25 (PCI)	AE18	PB13D	ad12 (PCI)
AE8	PB5A	ad24 (PCI)	AD17	PB14A	ad11 (PCI)
AC9	PB5B	idsel (PCI)	AF18	PB14B	ad47 (PCI)
AF8	PB5C	ad51 (PCI)	AE19	PB14C	ad46 (PCI)
AD8	PB5D	ad23 (PCI)	AF19	PB14D	ad10 (PCI)
AE9	PB6A	ad22 (PCI)	AD18	PB15A	INIT
AF9	PB6B	ad21 (PCI)	AE20	PB15B	ad45 (PCI)
AE10	PB6C	ad50 (PCI)	AC19	PB15C	ad44 (PCI)
AD9	PB6D	ad20 (PCI)	AF20	PB15D	ad9 (PCI)
AF10	PB7A	ad19 (PCI)	AD19	PB16A	NC
AC10	PB7B	ad18 (PCI)	AE21	PB16B	ad43 (PCI)
AE11	PB7C	ad17 (PCI)	AC20	PB16C	ad42 (PCI)
AD10	PB7D	ad16 (PCI)	AF21	PB16D	ad8 (PCI)
AF11	PB8A	c_ben3 (PCI)	AD20	PB17A	ad7 (PCI)
AE12	PB8B	c_ben2 (PCI)	AE22	PB17B	ad41 (PCI)
AF12	PB8C	trdyn (PCI)	AF22	PB17C	ad40 (PCI)
AD11	PB8D	ack64n (PCI)	AD21	PB17D	ad6 (PCI)
AE13	PB9A	req64n (PCI)	AE23	—	NC

Pin Information (continued)

Table 43. OR3TP12 352-Pin PBGA Pinout (continued)

Pin	OR3TP12	Function	Pin	OR3TP12	Function
AC22	PB18A	ad5 (PCI)	R25	PR11A	I/O-M3
AF23	PB18B	ad39 (PCI)	R26	PR11B	I/O
AD22	PB18C	ad38 (PCI)	T24	PR11C	I/O
AE24	—	NC	P25	PR11D	I/O
AD23	PB18D	ad4 (PCI)	R23	PR10A	I/O
AF24	DONE	DONE	P26	PR10B	I/O
AE26	RESET	RESET	R24	PR10C	I/O
AD25	PRGM	PRGM	N25	PR10D	I/O
AD26	PR18A	M0	N23	PECKR	I-ECKR
AC25	PR18B	ad37 (PCI)	N26	PR9B	I/O
AC24	PR18C	enumn (PCI)	P24	PR9C	I/O
AC26	PR18D	ledn (PCI)	M25	PR9D	I/O
AB25	PR17A	ad36 (PCI)	N24	PR8A	I/O
AB23	PR17B	ad3 (PCI)	M26	PR8B	I/O
AB24	PR17C	ad35 (PCI)	L25	PR8C	I/O
AB26	PR17D	ad34 (PCI)	M24	PR8D	I/O
AA25	PR16A	ad2 (PCI)	L26	PR7A	I/O-CS1
Y23	PR16B	ad33 (PCI)	M23	PR7B	I/O
AA24	PR16C	ad32 (PCI)	K25	PR7C	I/O
AA26	PR16D	ad1 (PCI)	L24	PR7D	I/O
Y25	PR15A	ad0 (PCI)	K26	PR6A	I/O-CS0
Y26	PR15B	par64n (PCI)	K23	PR6B	I/O
Y24	PR15C	ejectsw (PCI)	J25	PR6C	I/O
W25	PR15D	M1	K24	PR6D	I/O
V23	PR14A	I/O	J26	PR5A	I/O
W26	PR14B	I/O	H25	PR5B	I/O
W24	PR14C	I/O	H26	PR5C	I/O
V25	PR14D	I/O	J24	PR5D	I/O
V26	PR13A	I/O	G25	PR4A	I/O-RD/MPI_STRB
U25	PR13B	I/O	H23	PR4B	I/O
V24	PR13C	I/O	G26	PR4C	I/O
U26	PR13D	I/O	H24	PR4D	I/O
U23	PR12A	I/O-M2	F25	PR3A	I/O
T25	PR12B	I/O	G23	PR3B	I/O
U24	PR12C	I/O	F26	PR3C	I/O
T26	PR12D	I/O	G24	PR3D	I/O

Pin Information (continued)

Table 43. OR3TP12 352-Pin PBGA Pinout (continued)

Pin	OR3TP12	Function	Pin	OR3TP12	Function
E25	PR2A	I/O- \overline{WR}	D17	PT12C	I/O
E26	PR2B	I/O	B16	PT12B	I/O
F24	—	NC	C17	PT12A	I/O-D5
D25	PR2C	I/O	A16	PT11D	I/O
E23	PR2D	I/O	B15	PT11C	I/O
D26	PR1A	I/O	A15	PT11B	I/O
E24	PR1B	I/O	C16	PT11A	I/O-D4
C25	PR1C	I/O	B14	PECKT	I-ECKT
D24	PR1D	I/O	D15	PT10C	I/O
C26	$\overline{RD_CFG}$	$\overline{RD_CFG}$	A14	PT10B	I/O
A25	PT18D	I/O-SECKUR	C15	PT10A	I/O-D3
B24	PT18C	I/O	B13	PT9D	I/O
A24	—	NC	D13	PT9C	I/O
B23	PT18B	I/O	A13	PT9B	I/O
C23	PT18A	I/O	C14	PT9A	I/O-D2
A23	PT17D	I/O-RDY/RCLK/MPI_ALE	B12	PT8D	I/O-D1
B22	PT17C	I/O	C13	PT8C	I/O
D22	PT17B	I/O	A12	PT8B	I/O
C22	PT17A	I/O	B11	PT8A	I/O-D0/DIN
A22	PT16D	I/O	C12	PT7D	I/O
B21	PT16C	I/O	A11	PT7C	I/O
D20	PT16B	I/O	D12	PT7B	I/O
C21	PT16A	I/O	B10	PT7A	I/O-DOUT
A21	PT15D	I/O-D7	C11	PT6D	I/O
B20	PT15C	I/O	A10	PT6C	I/O
A20	PT15B	I/O	D10	PT6B	I/O
C20	PT15A	I/O	B9	PT6A	I/O
B19	PT14D	I/O	C10	PT5D	I/O
D18	PT14C	I/O	A9	PT5C	I/O
A19	PT14B	I/O	B8	PT5B	I/O
C19	PT14A	I/O	A8	PT5A	I/O-TDI
B18	PT13D	I/O	C9	PT4D	I/O
A18	PT13C	I/O	B7	PT4C	I/O
B17	PT13B	I/O-D6	D8	PT4B	I/O
C18	PT13A	I/O	A7	PT4A	I/O
A17	PT12D	I/O	C8	PT3D	I/O

Pin Information (continued)

Table 43. OR3TP12 352-Pin PBGA Pinout (continued)

Pin	OR3TP12	Function	Pin	OR3TP12	Function
B6	PT3C	I/O	D19	Vss	Vss
D7	PT3B	I/O	D23	Vss	Vss
A6	PT3A	I/O-TMS	D4	Vss	Vss
C7	PT2D	I/O	D9	Vss	Vss
B5	PT2C	I/O	H4	Vss	Vss
A5	PT2B	I/O	J23	Vss	Vss
C6	—	NC	N4	Vss	Vss
B4	—	NC	P23	Vss	Vss
D5	PT2A	I/O	V4	Vss	Vss
A4	PT1D	I/O	W23	Vss	Vss
C5	PT1C	I/O	L11	Vss	Vss
B3	PT1B	I/O	L12	Vss	Vss
C4	PT1A	I/O-TCK	L13	Vss	Vss
A3	RD_DATA	RD_DATA/TDO	L14	Vss	Vss
A1	Vss	Vss	L15	Vss	Vss
A2	Vss	Vss	L16	Vss	Vss
A26	Vss	Vss	M11	Vss	Vss
AC13	Vss	Vss	M12	Vss	Vss
AC18	Vss	Vss	M13	Vss	Vss
AC23	Vss	Vss	M14	Vss	Vss
AC4	Vss	Vss	M15	Vss	Vss
AC8	Vss	Vss	M16	Vss	Vss
AD24	Vss	Vss	N11	Vss	Vss
AD3	Vss	Vss	N12	Vss	Vss
AE1	Vss	Vss	N13	Vss	Vss
AE2	Vss	Vss	N14	Vss	Vss
AE25	Vss	Vss	N15	Vss	Vss
AF1	Vss	Vss	N16	Vss	Vss
AF25	Vss	Vss	P11	Vss	Vss
AF26	Vss	Vss	P12	Vss	Vss
B2	Vss	Vss	P13	Vss	Vss
B25	Vss	Vss	P14	Vss	Vss
B26	Vss	Vss	P15	Vss	Vss
C24	Vss	Vss	P16	Vss	Vss
C3	Vss	Vss	R11	Vss	Vss
D14	Vss	Vss	R12	Vss	Vss

Pin Information (continued)

Table 43. OR3TP12 352-Pin PBGA Pinout (continued)

Pin	OR3TP12	Function
R13	VSS	VSS
R14	VSS	VSS
R15	VSS	VSS
R16	VSS	VSS
T11	VSS	VSS
T12	VSS	VSS
T13	VSS	VSS
T14	VSS	VSS
T15	VSS	VSS
T16	VSS	VSS
AA23	VDD	VDD
AA4	VDD	VDD
AC11	VDD	VDD
AC16	VDD	VDD
AC21	VDD	VDD
AC6	VDD	VDD
D11	VDD	VDD
D16	VDD	VDD
D21	VDD	VDD
D6	VDD	VDD
F23	VDD	VDD
F4	VDD	VDD
L23	VDD	VDD
L4	VDD	VDD
T23	VDD	VDD
T4	VDD	VDD

ALL DEVICES DISCONTINUED

Package Thermal Characteristics Summary

There are three thermal parameters that are in common use: Θ_{JA} , ψ_{JC} , and Θ_{JC} . It should be noted that all the parameters are affected, to varying degrees, by package design (including paddle size) and choice of materials, the amount of copper in the test board or system board, and system airflow.

Θ_{JA}

This is the thermal resistance from junction to ambient (theta-JA, R-theta, etc.).

$$\Theta_{JA} = \frac{T_J - T_A}{Q}$$

where T_J is the junction temperature, T_A is the ambient air temperature, and Q is the chip power.

Experimentally, Θ_{JA} is determined when a special thermal test die is assembled into the package of interest, and the part is mounted on the thermal test board. The diodes on the test chip are separately calibrated in an oven. The package/board is placed either in a JEDEC natural convection box or in the wind tunnel, the latter for forced convection measurements. A controlled amount of power (Q) is dissipated in the test chip's heater resistor, the chip's temperature (T_J) is determined by the forward drop on the diodes, and the ambient temperature (T_A) is noted. Note that Θ_{JA} is expressed in units of °C/watt.

ψ_{JC}

This JEDEC designated parameter correlates the junction temperature to the case temperature. It is generally used to infer the junction temperature while the device is operating in the system. It is not considered a true thermal resistance, and it is defined by:

$$\psi_{JC} = \frac{T_J - T_C}{Q}$$

where T_C is the case temperature at top dead center, T_J is the junction temperature, and Q is the chip power. During the Θ_{JA} measurements described above, besides the other parameters measured, an additional temperature reading, T_C , is made with a thermocouple attached at top-dead-center of the case. ψ_{JC} is also expressed in units of °C/watt.

Θ_{JC}

This is the thermal resistance from junction to case. It is most often used when attaching a heat sink to the top of the package. It is defined by:

$$\Theta_{JC} = \frac{T_J - T_C}{Q}$$

The parameters in this equation have been defined above. However, the measurements are performed with the case of the part pressed against a water-cooled heat sink to draw most of the heat generated by the chip out the top of the package. It is this difference in the measurement process that differentiates Θ_{JC} from ψ_{JC} . Θ_{JC} is a true thermal resistance and is expressed in units of °C/watt.

Θ_{JB}

This is the thermal resistance from junction to board (Θ_{JB}). It is defined by:

$$\Theta_{JB} = \frac{T_J - T_B}{Q}$$

where T_B is the temperature of the board adjacent to a lead measured with a thermocouple. The other parameters on the right-hand side have been defined above. This is considered a true thermal resistance, and the measurement is made with a water-cooled heat sink pressed against the board to draw most of the heat out of the leads. Note that Θ_{JB} is expressed in units of °C/watt, and that this parameter and the way it is measured are still in JEDEC committee.

FPGA Maximum Junction Temperature

Once the power dissipated by the FPGA has been determined (see the Estimating Power Dissipation section), the maximum junction temperature of the FPGA can be found. This is needed to determine if speed derating of the device from the 85 °C junction temperature used in all of the delay tables is needed. Using the maximum ambient temperature, T_{Amax} , and the power dissipated by the device, Q (expressed in °C), the maximum junction temperature is approximated by:

$$T_{Jmax} = T_{Amax} + (Q \cdot \Theta_{JA})$$

Table 44 lists the thermal characteristics for all packages used with the ORCA OR3TP12 Series of FPGAs.

Package Thermal Characteristics

Table 44. ORCA OR3TP12 Plastic Package Thermal Guidelines

Package ¹	Θ_{JA} (°C/W)			TA = 70 °C Max TJ = 125 °C Max 0 fpm (W)
	0 fpm	200 fpm	500 fpm	
256-Pin PBGA ^{2, 3}	22.5	19.0	17.5	2.4
352-Pin PBGA ^{2, 3}	19.0	16.0	15.0	2.9

1. Mounted on a 4-layer JEDEC standard test board with two power/ground planes.
2. With thermal balls connected to board ground plane.
3. The value of γ_{JC} for all packages is <1 °C/W.

Package Coplanarity

The coplanarity limits of the ORCA Series 3/3+ packages are as follows:

- PBGA: 8.0 mils

Package Parasitics

The electrical performance of an IC package, such as signal quality and noise sensitivity, is directly affected by the package parasitics. Table 45 lists eight parasitics associated with the ORCA packages. These parasitics represent the contributions of all components of a package, which include the bond wires, all internal package routing, and the external leads.

Four inductances in nH are listed: LSW and LSL, the self-inductance of the lead; and LMW and LML, the mutual inductance to the nearest neighbor lead. These parameters are important in determining ground bounce noise and inductive crosstalk noise. Three capacitances in pF are listed: CM, the mutual capacitance of the lead to the nearest neighbor lead; and C1 and C2, the total capacitance of the lead to all other leads (all other leads are assumed to be grounded). These parameters are important in determining capacitive crosstalk and the capacitive loading effect of the lead. Resistance values are in MW.

The parasitic values in Table 45 are for the circuit model of bond wire and package lead parasitics. If the mutual capacitance value is not used in the designer's model, then the value listed as mutual capacitance should be added to each of the C1 and C2 capacitors.

Package Parasitics (continued)

Table 45. ORCA OR3TP12 Package Parasitics

Package Type	LSW	LMW	Rw	C1	C2	CM	LSL	LML
256-Pin PBGA	5.0	2.0	220	1.0	1.0	1.0	5—13	2—6
352-Pin PBGA	5.0	2.0	220	1.5	1.5	1.5	7—17	3—8

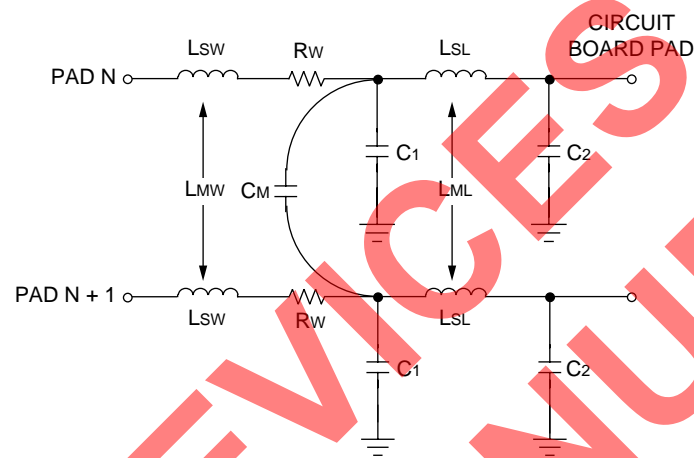

Figure 46. Package Parasitics

5-3862(C)r2

Package Outline Diagrams

Terms and Definitions

Basic Size (BSC):	The basic size of a dimension is the size from which the limits for that dimension are derived by the application of the allowance and the tolerance.
Design Size:	The design size of a dimension is the actual size of the design, including an allowance for fit and tolerance.
Typical (TYP):	When specified after a dimension, this indicates the repeated design size if a tolerance is specified or repeated basic size if a tolerance is not specified.
Reference (REF):	The reference dimension is an untoleranced dimension used for informational purposes only. It is a repeated dimension or one that can be derived from other values in the drawing.
Minimum (MIN) or Maximum (MAX):	Indicates the minimum or maximum allowable size of a dimension.

ALL DEVICES
DISCONTINUED

Package Outline Diagrams (continued)

256-Pin PBGA

Dimensions are in millimeters.

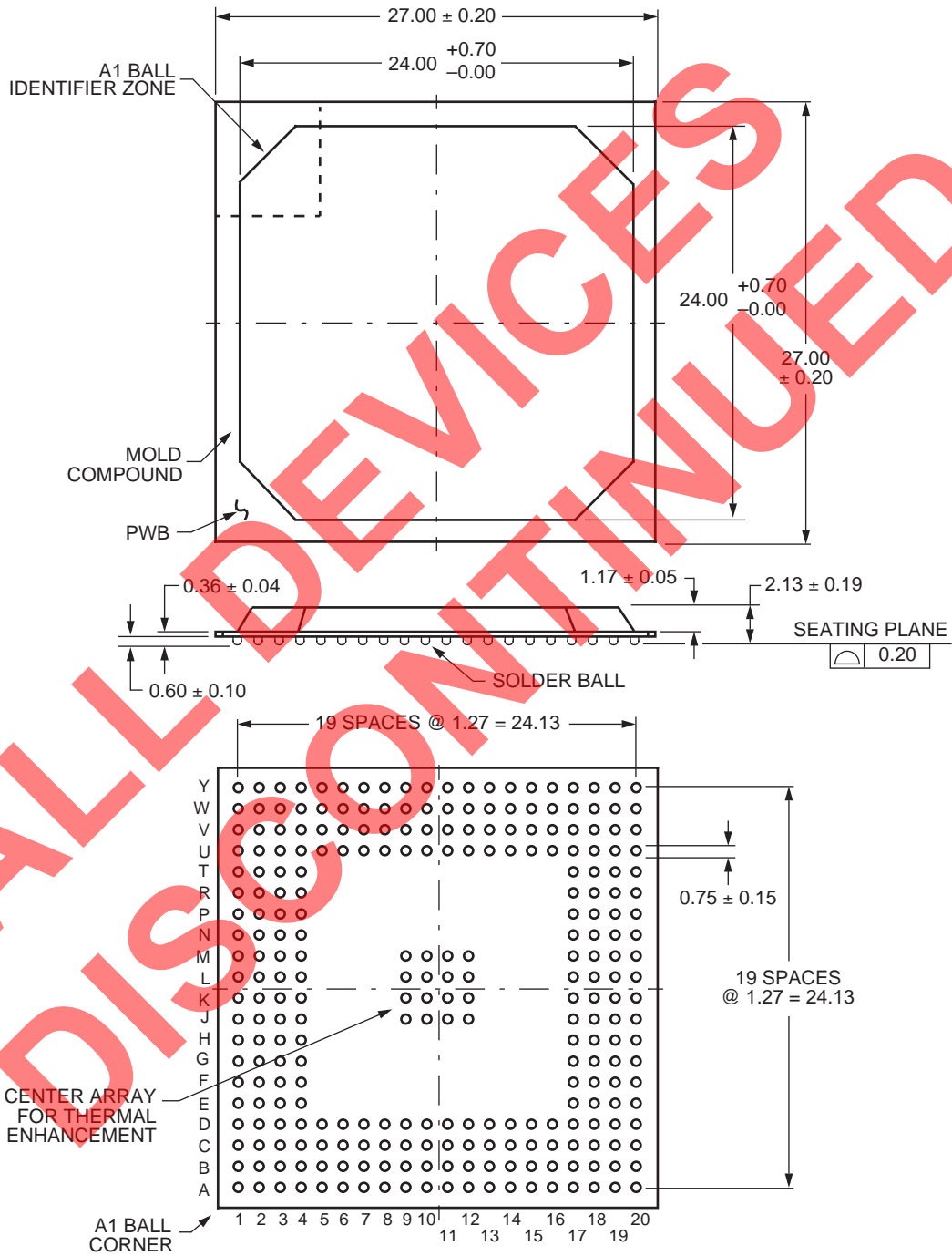

5-4406(F)

Package Outline Diagrams (continued)

352-Pin PBGA

Dimensions are in millimeters.

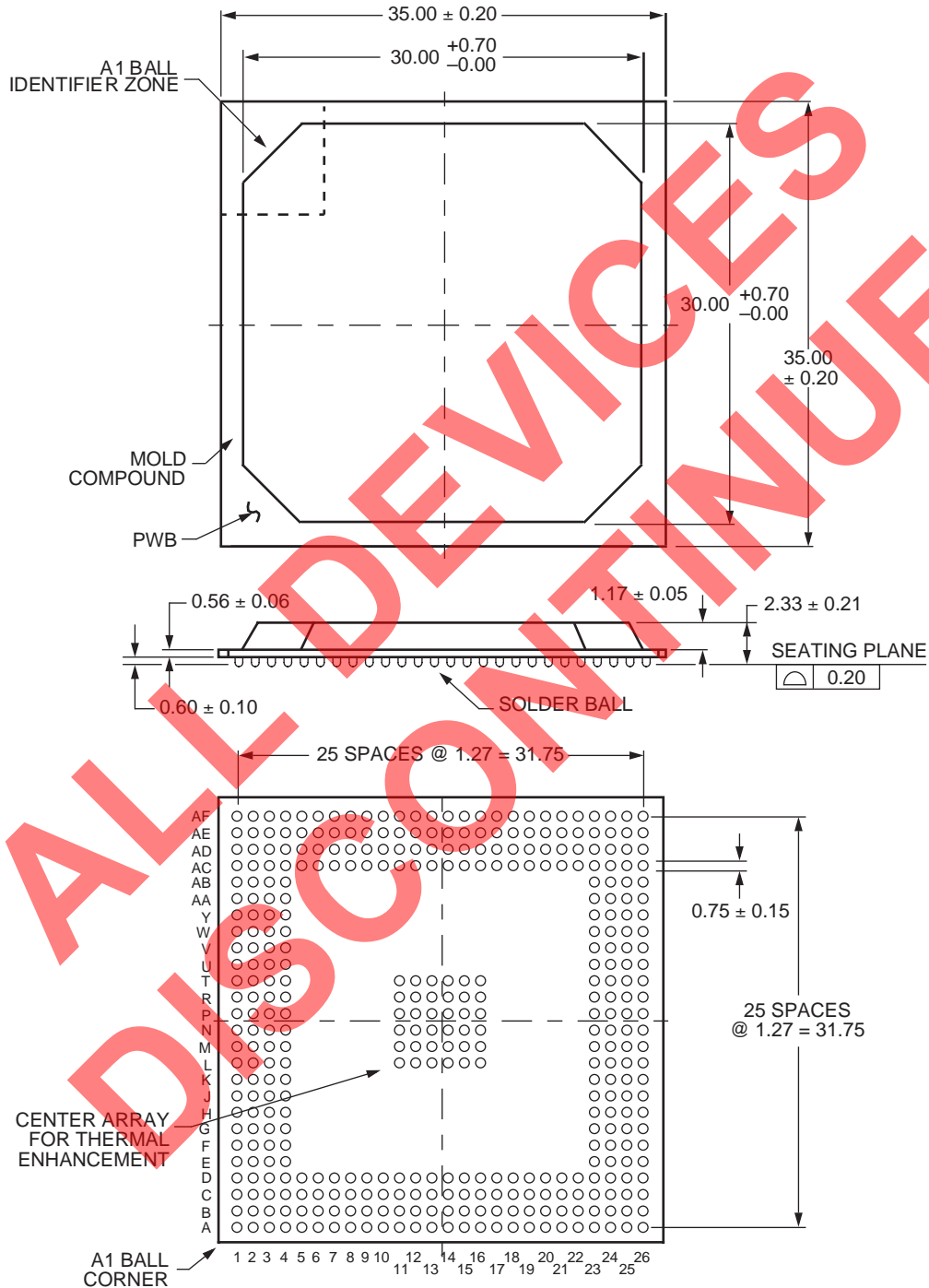

5-4407(F)

Ordering Information

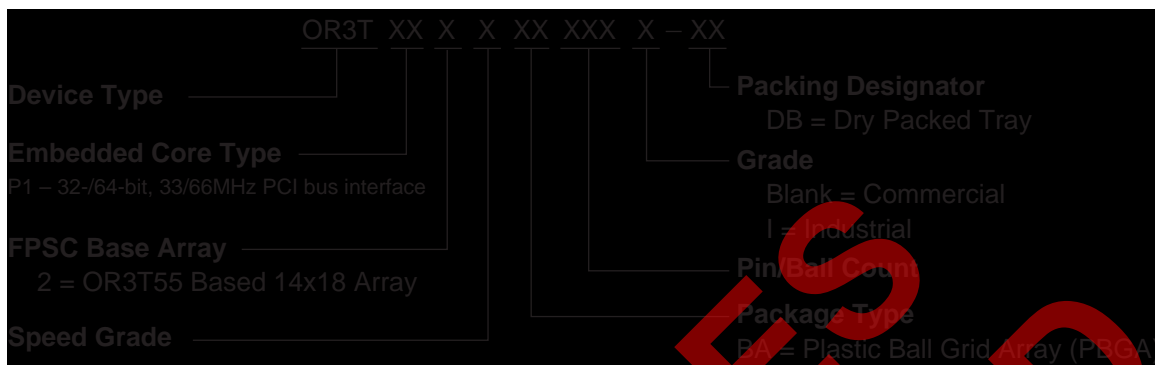

Table 46. Ordering Information

Device Family	Part Number	Speed Grade	Package Type	Ball Count	Grade	Packing Designator
OR3TP12	OR3TP127BA256-DB	7	PBGA	256	C	DB
	OR3TP127BA352-DB	7	PBGA	352	C	DB
	OR3TP126BA256-DB	6	PBGA	256	C	DB
	OR3TP126BA352-DB	6	PBGA	352	C	DB
	OR3TP126BA256I-DB	6	PBGA	256	I	DB

ALL DEVELOPMENT DISCONTINUED