

HITFET

Smart Low Side Power Switch

HITFET - BTS3028SDL

28 mOhm single channel smart low side power switch for 12V & 24V Application

Datasheet

Rev. 1.0, 2009-12-06

1	Overview	3
2	Block Diagram	5
2.1	Terms	5
3	Pin Configuration	6
3.1	Pin Assignment BTS3028SDL	6
3.2	Pin Definitions and Functions	6
4	General Product Characteristics	7
4.1	Absolute Maximum Ratings	7
4.2	Functional Range	7
4.3	Thermal Resistance	8
4.3.1	Transient Thermal Impedance	9
5	Input and Power Stage	10
5.1	Input Circuit	10
5.1.1	Failure Feedback	11
5.2	Power stage	11
5.2.1	Output On-state Resistance	11
5.2.2	Output Timing	13
5.3	Characteristics	14
6	Protection Functions	16
6.1	Thermal Protection	16
6.2	Overvoltage Protection	17
6.3	Short Circuit Protection	18
6.4	Characteristics	19
7	Package Outlines BTS3028SDL	20
8	Revision History	21



1 Overview

Features

- Short circuit and over load protection
- Thermal shutdown with latch behavior
- ESD protection
- Over voltage protection
- Logic level input suitable for 5V and 3.3V
- Analog driving possible
- 12V and 24V usability
- Green Product (RoHS compliant)
- AEC Qualified



PG-TO252-3-11

Description

The BTS3028SDL is a single channel low-side MOSFET power switch in PG-TO252-3-11 package providing embedded protective functions.

The device is monolithically integrated with a N channel vertical power FET and embedded protection functions. The BTS3028SDL is automotive qualified and can be used in 12V and 24V automotive and industrial applications.

Table 1 Product Summary

Drain voltage ¹⁾	V_D	60 V
Maximum Input Voltage	V_{IN}	10 V
Maximum On-State resistance at 150°C at 5V input voltage	$R_{DS(ON)}$	91 mΩ
Typical On-State resistance at 25°C and 10V input voltage	$R_{DS(ON)}$	28 mΩ
Nominal load current	$I_{D(nom)}$	5.0 A
Minimum current limitation level	$I_{D(lim)}$	18.0 A

1) Active clamped

Type	Package	Marking
BTS3028SDL	PG-TO252-3-11	

Protective Functions

- Electrostatic discharge protection (ESD)
- Active clamp over voltage protection
- Thermal shutdown with latch behavior
- Over load and Short circuit protection
- Current limitation

Analog Fault Information

- Thermal shutdown
- Short to Battery
- Overload

Applications

- Designed for inductive and lamp loads in automotive and industrial applications.
- 12V and 24V applications
- All types of resistive, inductive and capacitive loads
- Replaces discrete circuits

Detailed Description

The device is able to switch all kind of resistive, inductive and capacitive loads, limited by E_{AS} and maximum current capabilities.

The BTS3028SDL offers ESD protection on the IN Pin which refers to the Source pin (Ground).

The overtemperature protection prevents the device from overheating due to overload and/or bad cooling conditions. The temperature information is given by a temperature sensor in the power MOSFET. During thermal shutdown the device sinks an increased input current at the IN pin to feedback the fault condition.

The BTS3028SDL has a thermal-latch function. The device will turn off and stay off, even after the measured temperature has dropped below the thermal hysteresis. After cooling down the device can be switched on again by toggling the IN pin.

The over voltage protection gets activated during load dump or inductive turn off conditions. The power MOSFET is limiting the drain-source voltage, if it rises above the $V_{DS(\text{clamp})}$.

2 Block Diagram

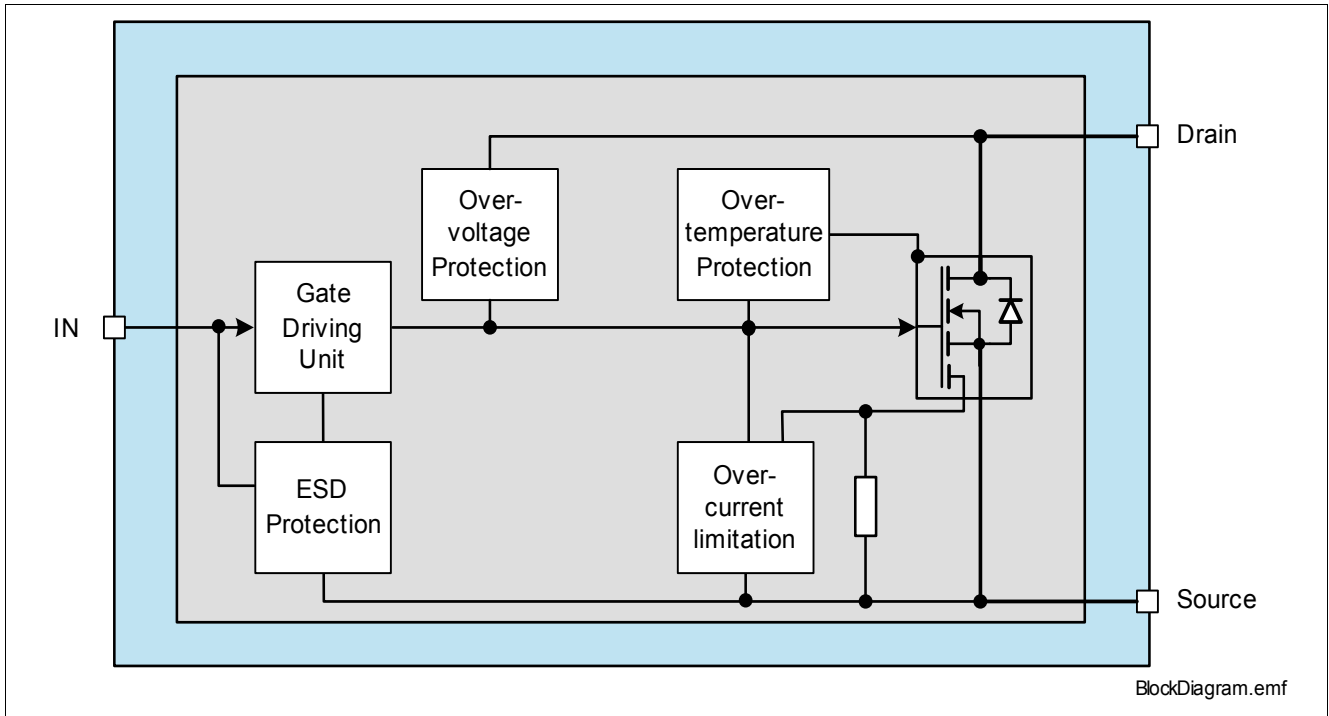

Figure 1 Block Diagram

2.1 Terms

Figure 2 shows all external terms used in this data sheet.

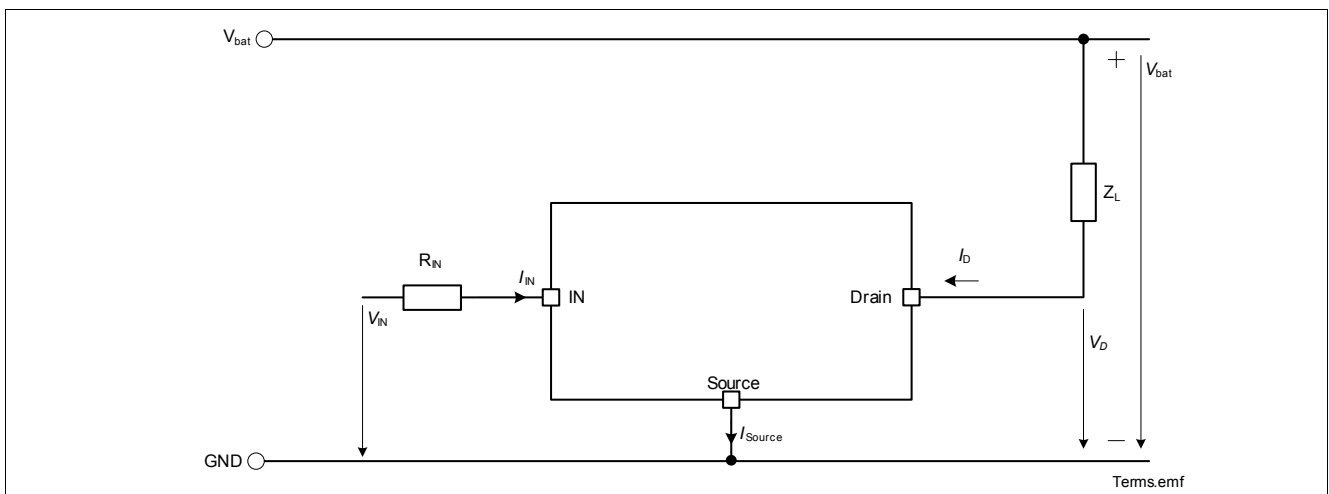

Figure 2 Naming of electrical parameters

3 Pin Configuration

3.1 Pin Assignment BTS3028SDL

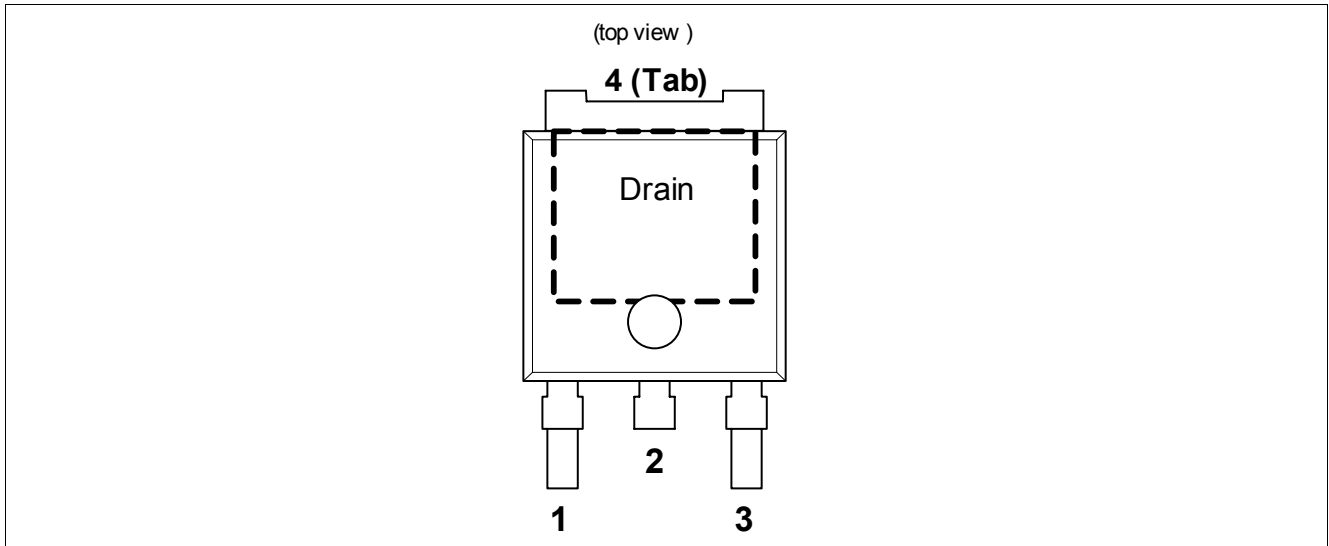

Figure 3 Pin Configuration PG-TO252-3-11

3.2 Pin Definitions and Functions

Pin	Symbol	Function
1	IN	Input and fault feedback
2,4	Drain	Load connection for power DMOS
3	Source	Ground, Source of power DMOS

4 General Product Characteristics

4.1 Absolute Maximum Ratings

Absolute Maximum Ratings¹⁾

$T_j = -40\text{ °C}$ to $+150\text{ °C}$; all voltages with respect to ground, positive current flowing into pin
(unless otherwise specified)

Pos.	Parameter	Symbol	Limit Values		Unit	Test Conditions
			Min.	Max.		
Voltages						
4.1.1	Drain voltage	V_D	–	60	V	²⁾ $V_{IN} = 0\text{ V}$, $I_D = 10\text{ mA}$
4.1.2	Drain voltage for short circuit protection	$V_{D(SC)}$	–	36	V	$V_{IN} = 5\text{ V}$
4.1.3	Input Current	I_{IN}	self limited		mA	$-0.2\text{ V} < V_{IN} < 10\text{ V}$
			-2	2	mA	$V_{IN} < -0.2\text{ V}$ or $V_{IN} > 10\text{ V}$
4.1.4	Drain Current	I_D	–	18	A	³⁾

Energies

4.1.5	Unclamped single pulse inductive energy single pulse	E_{AS}	–	350	mJ	$I_{D(start)} = 7.5\text{ A}$ $V_{bat} = 24\text{ V}$; $T_{J(start)} = 150\text{ °C}$
-------	--	----------	---	-----	----	--

Temperatures

4.1.6	Operating temperature	T_J	-40	+150	°C	–
4.1.7	Storage temperature	T_{STG}	-55	+150	°C	–

ESD Susceptibility

4.1.8	ESD Resistivity	V_{ESD}	-2	2	kV	HBM ⁴⁾
-------	-----------------	-----------	----	---	----	-------------------

1) Not subject to production test, specified by design.

2) Active clamped.

3) Active limited

4) ESD susceptibility, HBM according to EIA/JESD 22-A114, Pin Source connected to Ground

Note: Stresses above the ones listed here may cause permanent damage to the device. Exposure to absolute maximum rating conditions for extended periods may affect device reliability.

Note: Integrated protection functions are designed to prevent IC destruction under fault conditions described in the data sheet. Fault conditions are considered as "outside" normal operating range. Protection functions are not designed for continuous repetitive operation

4.2 Functional Range

Pos.	Parameter	Symbol	Limit Values		Unit	Conditions
			Min.	Max.		
4.2.1	Input pin voltage (device ON)	V_{IN}	2	10	V	–
4.2.2	Drain voltage	V_D	2.5	36	V	–

Pos.	Parameter	Symbol	Limit Values		Unit	Conditions
			Min.	Max.		
4.2.3	Input pin current consumption	$I_{IN(ON)}$	–	30	μA	normal operation
4.2.4	Input pin feedback current	$I_{IN(lim)}$	–	400	μA	fault indication

Note: Within the functional range the IC operates as described in the circuit description. The electrical characteristics are specified within the conditions given in the related electrical characteristics table.

4.3 Thermal Resistance

Note: This thermal data was generated in accordance with JEDEC JESD51 standards.

For more information, go to www.jedec.org.

Pos.	Parameter	Symbol	Limit Values			Unit	Conditions
			Min.	Typ.	Max.		
4.3.5	Junction to Case	R_{thJC}	–	–	0.5	K/W	1) 2)
4.3.6	Junction to Ambient (2s2p)	$R_{thJA(2s2p)}$	–	25	–	K/W	1) 3)
4.3.7	Junction to Ambient (1s0p+600mm ² Cu)	$R_{thJA(1s0p)}$	–	46	–	K/W	1) 4)

- 1) Not subject to production test, specified by design
- 2) Specified R_{thJC} value is simulated at natural convection on a cold plate setup (all pins are fixed to ambient temperature). $T_a = 25\text{ °C}$. Device is loaded with 1W power.
- 3) Specified R_{thJA} value is according to Jedec JESD51-2,-7 at natural convection on FR4 2s2p board; The product (Chip+Package) was simulated on a 76.2 x 114.3 x 1.5 mm board with 2 inner copper layers (2 x 70 μm Cu, 2 x 35 μm Cu). $T_a = 25\text{ °C}$, Device is loaded with 1W power.
- 4) Specified R_{thJA} value is according to Jedec JESD51-2,-3 at natural convection on FR4 1s0p board; The product (Chip+Package) was simulated on a 76.2 x 114.3 x 1.5 mm board with additional heatspreading copper area of 600mm² and 70 μm thickness. $T_a = 25\text{ °C}$, Device is loaded with 1W power.

4.3.1 Transient Thermal Impedance

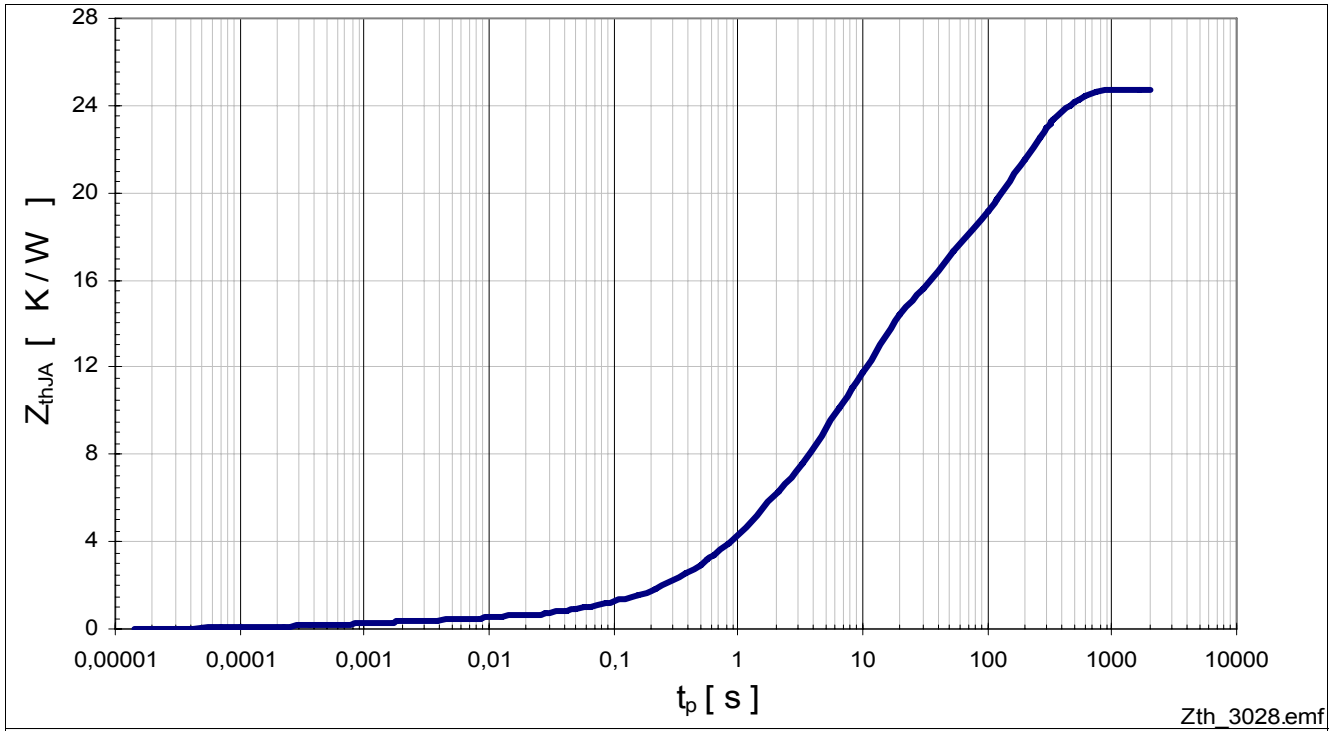

Figure 4 Typical transient thermal impedance

$$Z_{thJA} = f(t_p), T_a = 25\text{ °C}$$

Value is according to Jecdec JESD51-2,-7 at natural convection on FR4 2s2p board;

The product (Chip+Package) was simulated on a 76.2 x 114.3 x 1.5 mm³ board with 2 inner copper layers (2 x 70 μm Cu, 2 x 35 μm Cu). Device is dissipating 1 W power.

5 Input and Power Stage

5.1 Input Circuit

Figure 5 shows the input circuit of the BTS3028SDL. The Zener Diode Z_D protects the input circuit against ESD pulses. The internal circuitry is powered via the input pin. During normal operation the Input is connected to the Gate of the power MOSFET. During fault condition the device sinks the current $I_{IN(fault)}$ to give the fault information back to the driving circuit. The current handling capability of the driving circuit does not influence the device behavior as long as the supply current I_{IN} is supplied.



Figure 5 Input Circuit

The following Figure shows the typical input threshold voltage of BTS3028SDL.

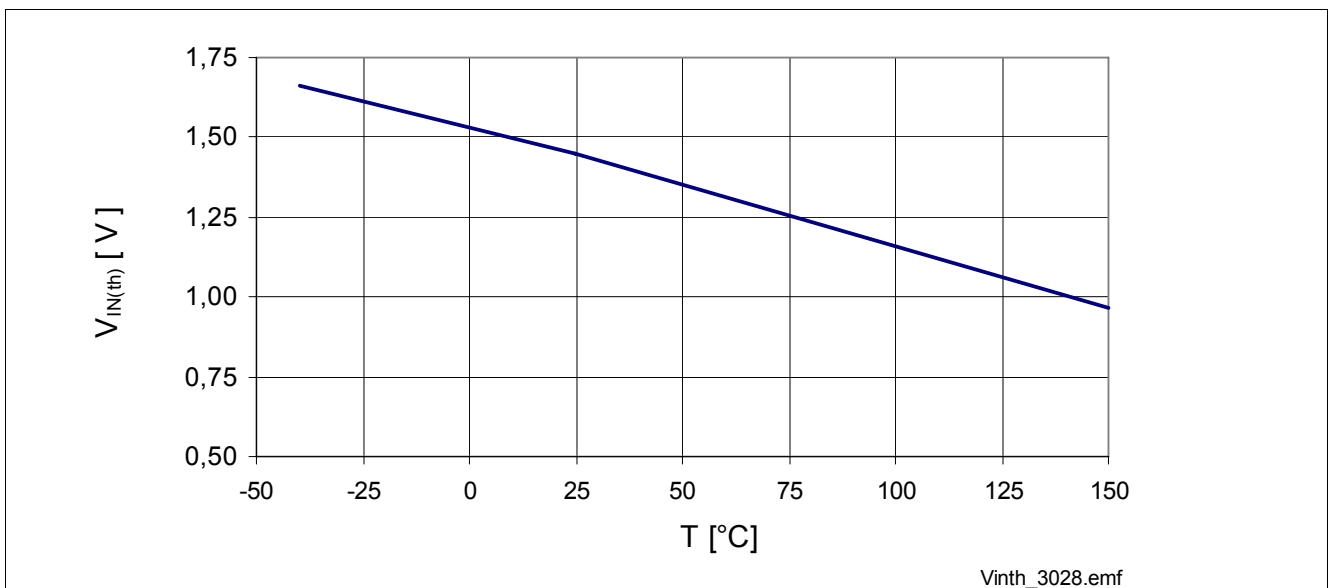

Figure 6 Typical Input Threshold Voltage $V_{in\text{th}} = f(T_J)$; $I_D = 1.2\text{mA}$, $V_D = V_{IN}$

The following Figure shows the typical transfer characteristic of BTS3028SDL.

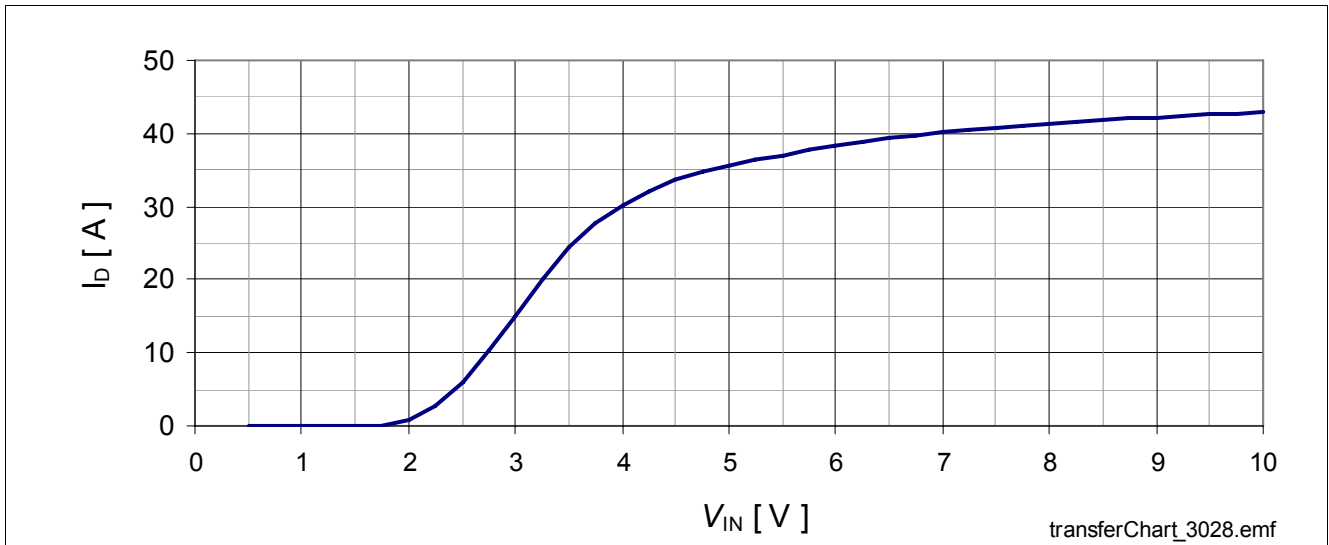

Figure 7 Typical Transfer Characteristic $I_D = f(V_{IN})$; $V_D = 13.5 \text{ V}$, $T_{J(\text{start})} = 25 \text{ }^\circ\text{C}$

5.1.1 Failure Feedback

During failure condition the BTS3028SDL sinks the increased current $I_{IN(\text{fault})}$.

5.2 Power stage

5.2.1 Output On-state Resistance

The on-state resistance depends on the junction temperature T_J and on the applied input voltage. The following Figures show this dependencies for the typical on-state resistance $R_{DS(\text{on})}$.

Temperature dependency of $R_{DS(\text{on})}$ at 3 different input voltage conditions:

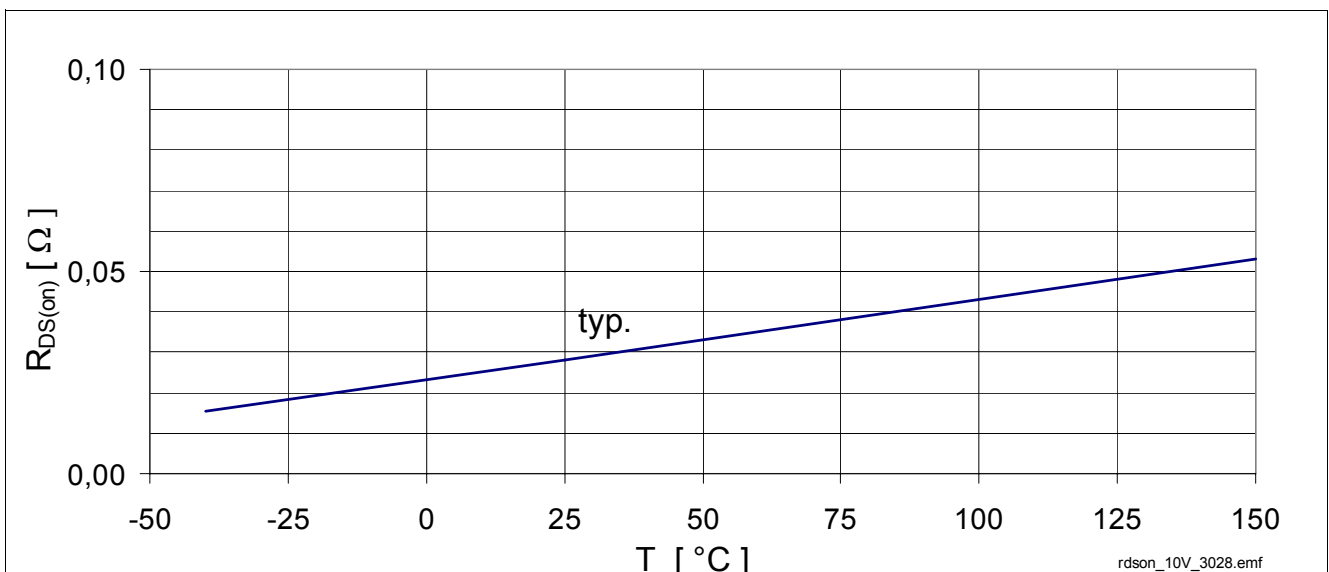

Figure 8 Typical On-State Resistance, $R_{DS(\text{on})} = f(T_J)$, $V_{IN} = 10 \text{ V}$

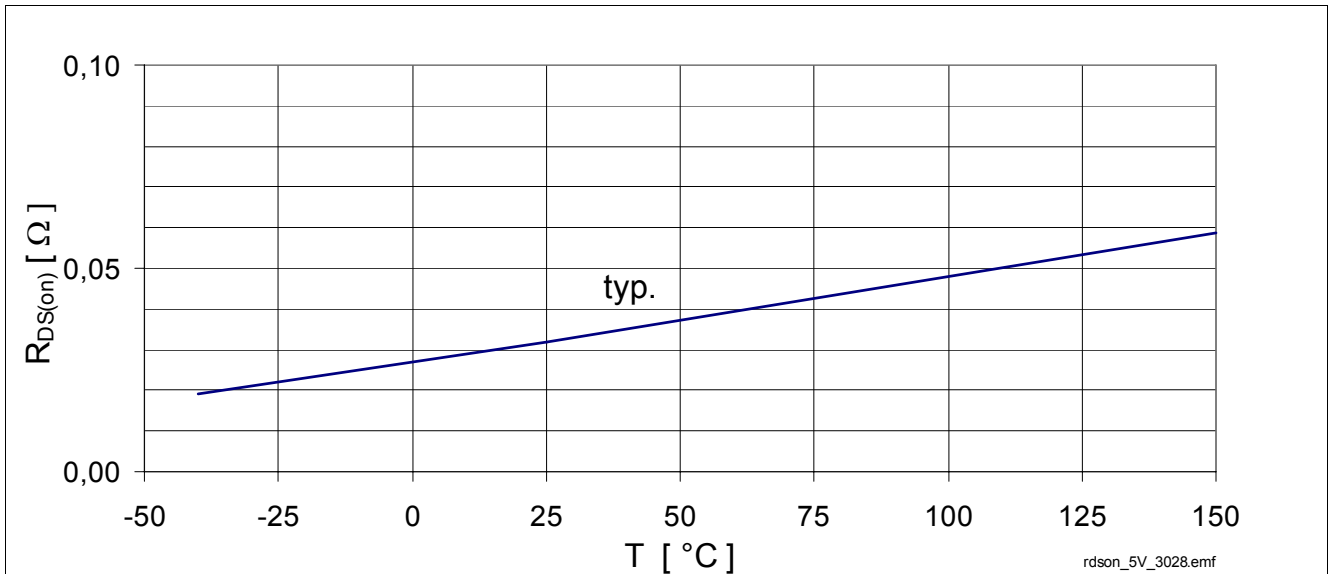

Figure 9 Typical On-State Resistance, $R_{DS(on)} = f(T_J)$, $V_{IN} = 5\text{V}$

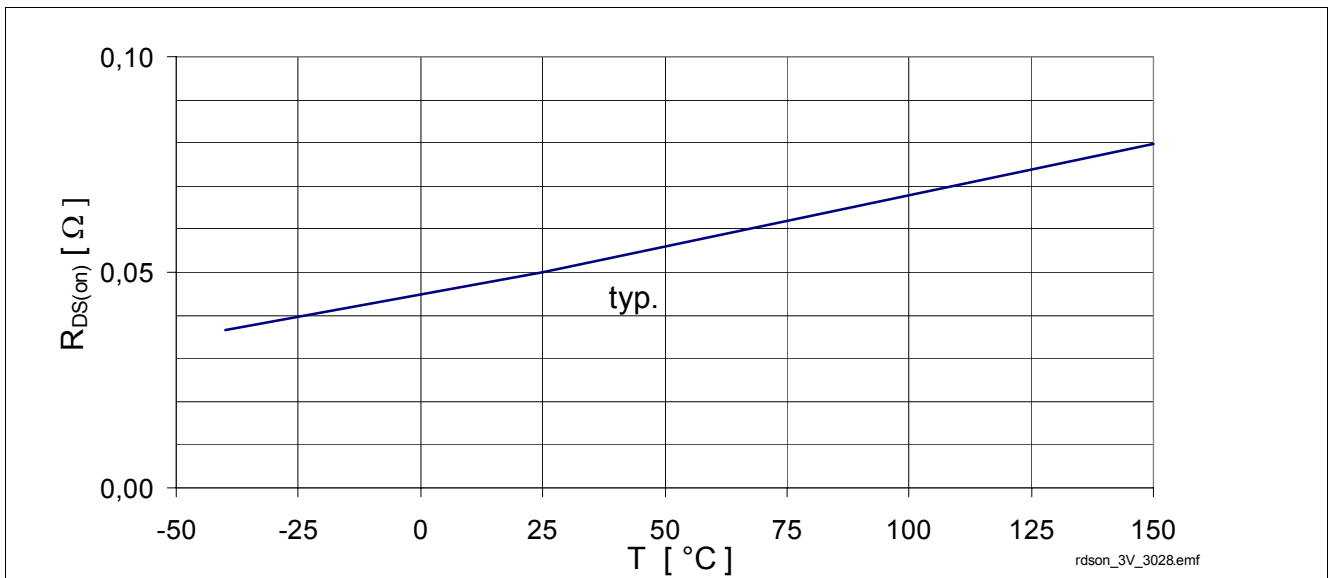

Figure 10 Typical On-State Resistance, $R_{DS(on)} = f(T_J)$, $V_{IN} = 3\text{V}$

5.2.2 Output Timing

A voltage signal at the input pin above the threshold voltage causes the power MOSFET to switch on.

Figure 11 shows the timing definition.

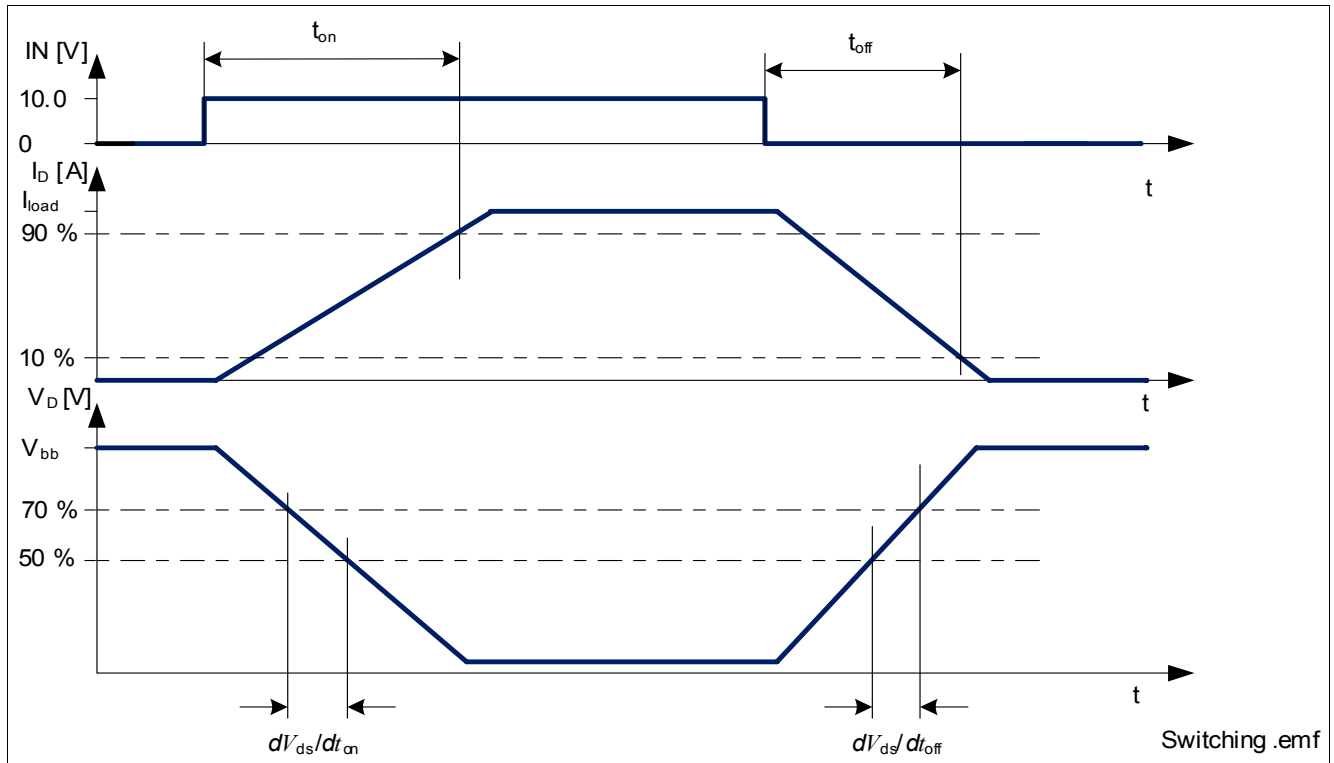

Figure 11 Definition of Power Output Timing for Resistive Load

5.3 Characteristics

Note: Characteristics show the deviation of parameter at given input voltage and junction temperature. Typical values show the typical parameters expected from manufacturing.

All voltages with respect to Source Pin unless otherwise stated.

Electrical Characteristics: Input and Power Stage

$T_j = -40\text{ °C}$ to $+150\text{ °C}$, $V_{bat} = 8.0\text{ V}$ to 36 V , all voltages with respect to ground, positive current flowing into pin (unless otherwise specified)

Pos.	Parameter	Symbol	Limit Values			Unit	Test Conditions
			Min.	Typ.	Max.		
Input							
5.3.1	Supply current from Input Pin	$I_{IN(nom)}$	–	10	30	μA	$V_D = 0\text{ V}$; $V_{IN} = 10\text{ V}$
5.3.2	Input current protection mode	$I_{IN(lim)}$	–	100	400	μA	$V_{IN} = 10\text{ V}$; $T_J = 150\text{ °C}$
5.3.3	Input threshold voltage	$V_{IN(th)}$	0.8	1.4	2	V	$V_D = V_{IN}$; $I_D = 1.2\text{ mA}$
Power Stage							
5.3.4	On-State Resistance	$R_{DS(on)}$	–	28	–	$\text{m}\Omega$	$T_J = 25\text{ °C}$; $V_{IN} = 10\text{ V}$; $I_D = 6\text{ A}$
			–	53	75	$\text{m}\Omega$	$T_J = 150\text{ °C}$; $V_{IN} = 10\text{ V}$; $I_D = 6\text{ A}$
			–	32	–	$\text{m}\Omega$	$T_J = 25\text{ °C}$; $V_{IN} = 5\text{ V}$; $I_D = 6\text{ A}$
			–	60	91	$\text{m}\Omega$	$T_J = 150\text{ °C}$; $V_{IN} = 5\text{ V}$; $I_D = 6\text{ A}$
			–	50	–	$\text{m}\Omega$	¹⁾ $T_J = 25\text{ °C}$; $V_{IN} = 3\text{ V}$; $I_D = 6\text{ A}$
			–	80	128	$\text{m}\Omega$	¹⁾ $T_J = 150\text{ °C}$; $V_{IN} = 3\text{ V}$; $I_D = 6\text{ A}$
5.3.5	Nominal load current	$I_{D(nom)}$	5.0	5.8	–	A	¹⁾ $T_J < 150\text{ °C}$; $T_A = 105\text{ °C}$; $V_{IN} = 10\text{ V}$; $V_{DS} = 0.5\text{ V}$
5.3.6	Zero input voltage drain current	I_{DSS}	–	2.5	6	μA	$V_D = 36\text{ V}$; $V_{IN} = 0\text{ V}$; $T_J = -40\text{ °C}$ to 85 °C
			–	8	16	μA	$V_D = 36\text{ V}$; $V_{IN} = 0\text{ V}$; $T_J = 150\text{ °C}$

Electrical Characteristics: Input and Power Stage (cont'd)

$T_j = -40\text{ °C}$ to $+150\text{ °C}$, $V_{bat} = 8.0\text{ V}$ to 36 V , all voltages with respect to ground, positive current flowing into pin (unless otherwise specified)

Pos.	Parameter	Symbol	Limit Values			Unit	Test Conditions	
			Min.	Typ.	Max.			
Switching (see Figure 11 for definition details)								
5.3.7	Turn-on time	t_{on}	–	50	100	μs	$V_{bb}=13.5\text{V}$, $R_L=4.7\ \Omega$ $T_j = -40\text{ °C}$ to 85 °C	
				60	120			$T_j = 150\text{ °C}$
5.3.8	Turn-off time	t_{off}	–	80	120	μs	$V_{bb}=13.5\text{V}$, $R_L=4.7\ \Omega$ $T_j = -40\text{ °C}$ to 85 °C	
				120	200			$T_j = 150\text{ °C}$
				80	200			μs
5.3.9	Slew rate on	$-dV_{ds}/dt_{on}$	–	0.7	1.5	$\text{V}/\mu\text{s}$	$V_{bb}=13.5\text{V}$, $R_L=4.7\ \Omega$	
				0.7	1.5			μs
5.3.10	Slew rate off	dV_{ds}/dt_{off}	–	0.7	1.5	$\text{V}/\mu\text{s}$	$V_{bb}=13.5\text{V}$, $R_L=4.7\ \Omega$	
				0.7	1.5			μs
Inverse Diode								
5.3.11	Inverse Diode forward voltage	$V_{D,inverted}$	–	-1.0	-1.5	V	$I_D = -51\text{A}$ $V_{IN} = 0\text{ V}$	

1) Not subject to production test, calculated by R_{thJA} and $R_{DS(on)}$.

6 Protection Functions

The device provides embedded protection functions. Integrated protection functions are designed to prevent IC destruction under fault conditions described in the data sheet. Fault conditions are considered as “outside” normal operation.

6.1 Thermal Protection

The device is protected against over temperature due to overload and / or bad cooling conditions. To ensure this a temperature sensor located in the Power MOSFET is used.

The BTS3028SDL has a thermal-latch function. The device will turn off and stay off, even after the measured temperature has dropped below the thermal hysteresis. After cooling down the device can be switched on again by toggling the IN pin.

The protective switch off can be reset by setting the input pin voltage to low. Then the internal logic is not supplied anymore and the next time the voltage on the IN pin rises above the input threshold voltage, the device will switch on, if the temperature is not above the over temperature threshold.

see [Figure 12](#).

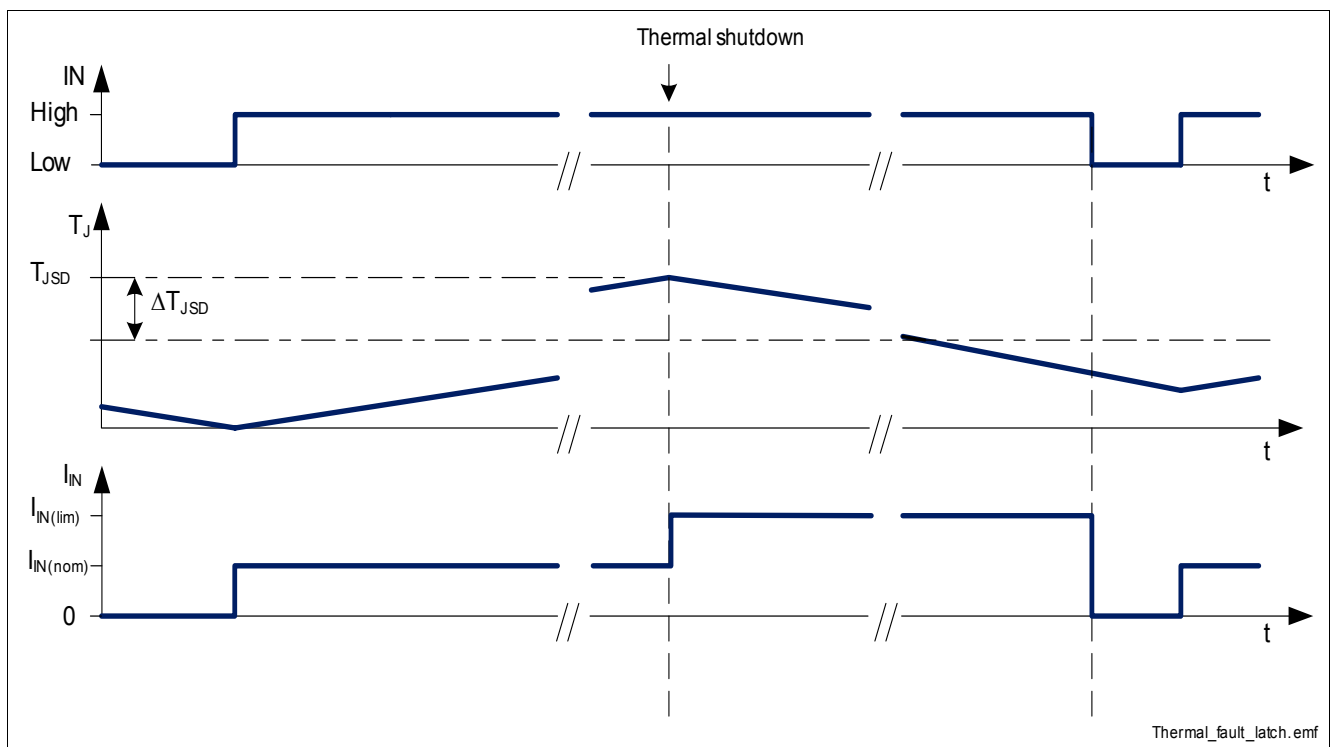

Figure 12 Error Signal via Input Current at Thermal Shutdown

6.2 Overvoltage Protection

When switching off inductive loads with low-side switches, the Drain-Source voltage V_D rises above battery potential, because the inductance intends to continue driving the current.

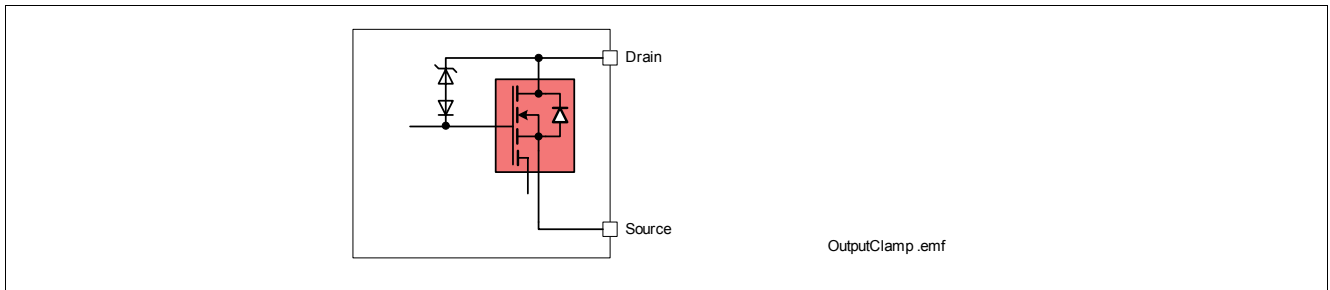

Figure 13 Output Clamp

The BTS3028SDL is equipped with a voltage clamp mechanism that prevents the Drain-Source voltage to rise above $V_{D(Clamp)}$. See [Figure 13](#) and [Figure 14](#) for more details.

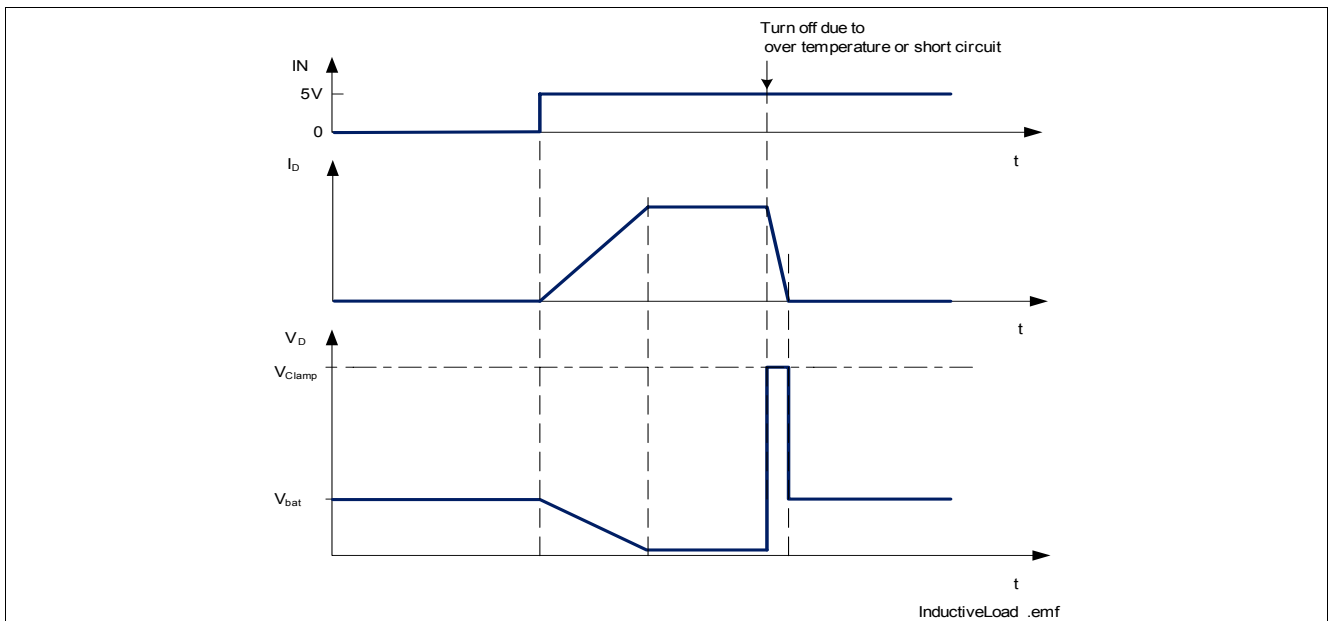

Figure 14 Switching an Inductance

While demagnetization of inductive loads, energy has to be dissipated in the BTS3028SDL. This energy can be calculated by the following equation:

$$E = V_{D(Clamp)} \cdot \left[\frac{V_{bat} - V_{D(Clamp)}}{R_L} \cdot \ln \left(1 - \frac{R_L \cdot I_L}{V_{bat} - V_{D(Clamp)}} \right) + I_L \right] \cdot \frac{L}{R_L}$$

Following equation simplifies under assumption of $R_L = 0$

$$E = \frac{1}{2} L I_L^2 \cdot \left(1 - \frac{V_{bat}}{V_{D(Clamp)}} \right)$$

[Figure 16](#) shows the inductance / current combination the BTS3028SDL can handle.

For maximum single avalanche energy please also refer to E_{AS} value in “Energies” on Page 7

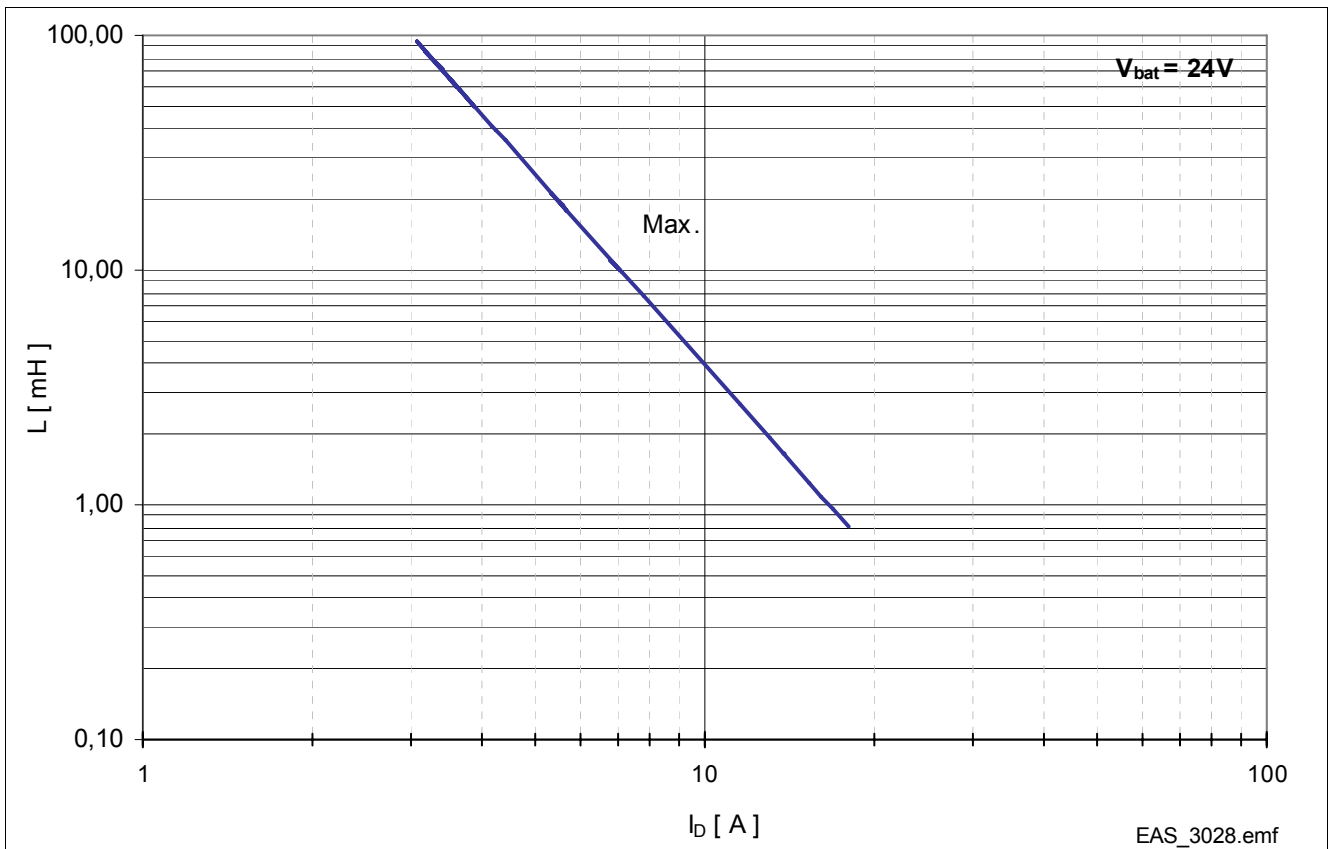

Figure 15 Maximum load inductance for single pulse
 $L = f(I_D)$, $T_{j(start)} = 150\text{ °C}$, $V_{bat} = 24V$

6.3 Short Circuit Protection

The condition short circuit is an overload condition of the device. If the current reaches the limitation value of $I_{D(lim)}$ the device limits the current and starts heating up. When the thermal shutdown temperature is reached, the device turns off.

The time from the beginning of current limitation until the over temperature switch off depends strongly on the cooling conditions.

The device sinks higher current on IN pin during the protective switch off and switches back ON after the IN toggles.

Figure 16 shows this behavior.

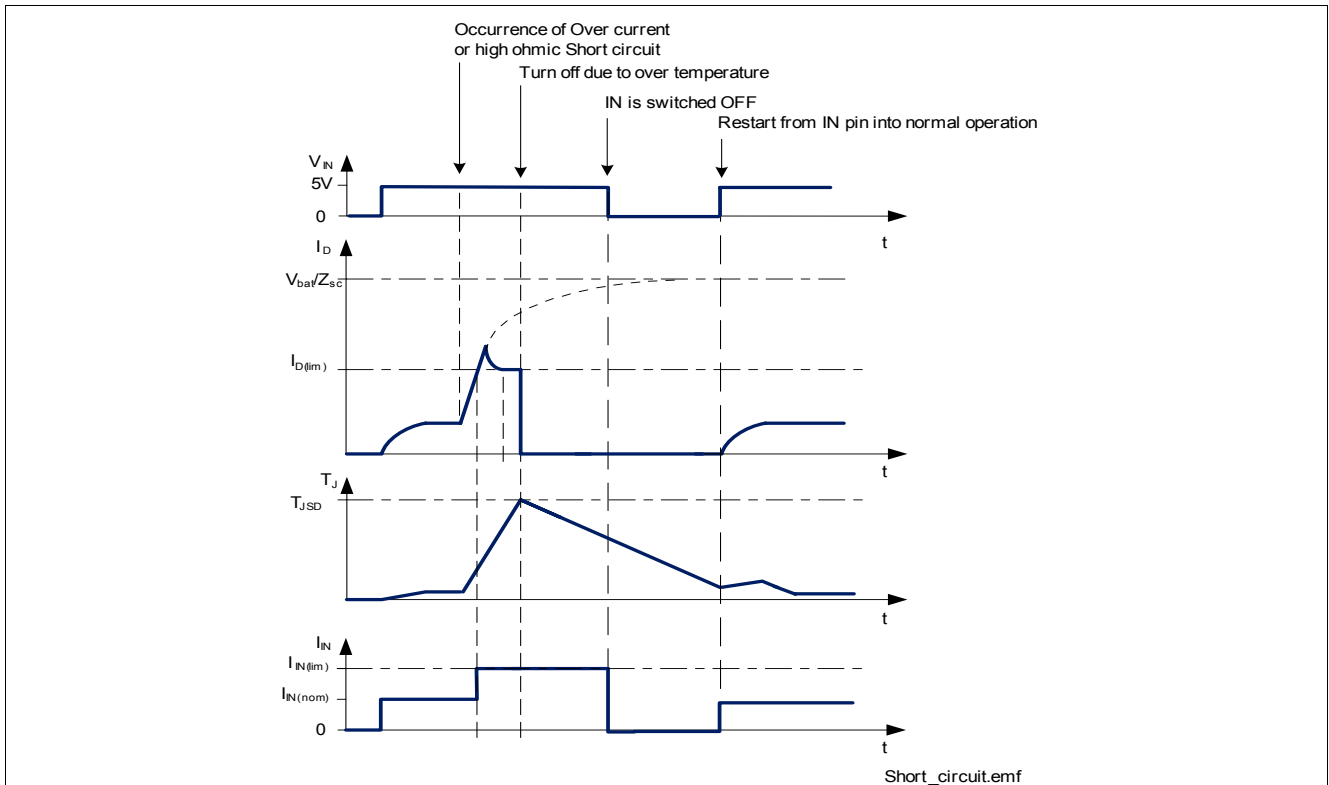
Figure 16 Short circuit protection via current limitation and over temperature switch off

6.4 Characteristics

Note: Characteristics show the deviation of parameter at given input voltage and junction temperature. Typical values show the typical parameters expected from manufacturing.

Electrical Characteristics: Protection Functions

Unless otherwise specified: $T_j = -40\text{ °C to }+150\text{ °C}$, $V_{bat} = 8.0\text{ V to }36\text{ V}$

Pos.	Parameter	Symbol	Limit Values			Unit	Test Conditions
			Min.	Typ.	Max.		
Thermal Protection							
6.4.1	Thermal shut down junction temperature	T_{JSD}	150	175 ¹⁾	–	°C	–
6.4.2	Thermal hysteresis	ΔT_{JSD}	–	10	–	K	¹⁾
Overvoltage Protection							
6.4.3	Drain clamp voltage	$V_{D(Clamp)}$	60	–	75	V	$V_{IN} = 0\text{ V}; I_D = 10\text{ mA}$
Current limitation							
6.4.4	Current limitation	$I_{D(lim)}$	18	45	58	A	$V_{IN} = 10\text{ V};$ $V_D = 13.5\text{ V};$ $t_{measure} = 200\mu\text{s}$

1) Not subject to production test, specified by design.

7 Package Outlines BTS3028SDL

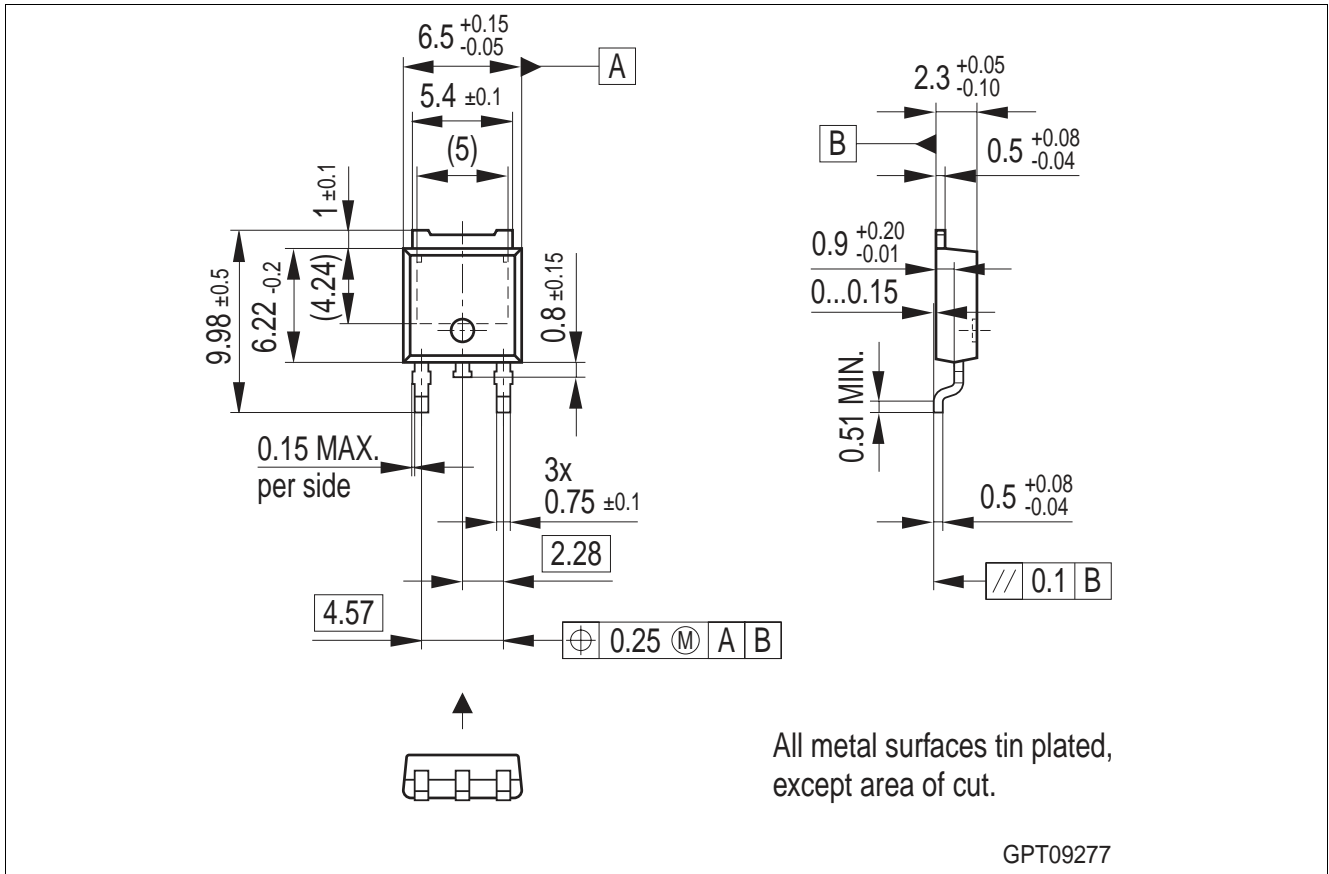

Figure 17 PG-T0252-3-11 (Plastic Dual Small Outline Package)

Green Product (RoHS compliant)

To meet the world-wide customer requirements for environmentally friendly products and to be compliant with government regulations the device is available as a green product. Green products are RoHS-Compliant (i.e Pb-free finish on leads and suitable for Pb-free soldering according to IPC/JEDEC J-STD-020).

8 Revision History

Version	Date	Changes
Rev. 1.0	2009-12-06	initial released data sheet

Edition 2009-12-06

**Published by
Infineon Technologies AG
81726 Munich, Germany**

**© 2009 Infineon Technologies AG
All Rights Reserved.**

Legal Disclaimer

The information given in this document shall in no event be regarded as a guarantee of conditions or characteristics. With respect to any examples or hints given herein, any typical values stated herein and/or any information regarding the application of the device, Infineon Technologies hereby disclaims any and all warranties and liabilities of any kind, including without limitation, warranties of non-infringement of intellectual property rights of any third party.

Information

For further information on technology, delivery terms and conditions and prices, please contact the nearest Infineon Technologies Office (www.infineon.com).

Warnings

Due to technical requirements, components may contain dangerous substances. For information on the types in question, please contact the nearest Infineon Technologies Office.

Infineon Technologies components may be used in life-support devices or systems only with the express written approval of Infineon Technologies, if a failure of such components can reasonably be expected to cause the failure of that life-support device or system or to affect the safety or effectiveness of that device or system. Life support devices or systems are intended to be implanted in the human body or to support and/or maintain and sustain and/or protect human life. If they fail, it is reasonable to assume that the health of the user or other persons may be endangered.