

# SN74AHCT138Q-Q1

## 3-LINE TO 8-LINE DECODER/DEMULTIPLEXER

SGDS022A – FEBRUARY 2002 – REVISED APRIL 2008

- Qualified for Automotive Applications
- EPIC™ (Enhanced-Performance Implanted CMOS) Process
- Inputs Are TTL-Voltage Compatible
- Designed Specifically for High-Speed Memory Decoders and Data-Transmission Systems
- Incorporates Three Enable Inputs to Simplify Cascading and/or Data Reception
- Latch-Up Performance Exceeds 250 mA Per JESD 17
- ESD Protection Exceeds 2000 V Per MIL-STD-883C, Method 3015; Exceeds 200 V Using Machine Model (C = 200 pF, R = 0)

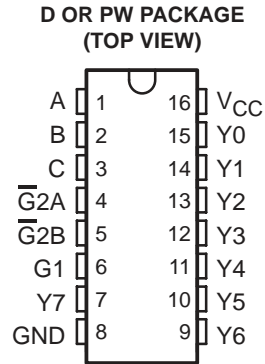

### description

The SN74AHCT138Q 3-line to 8-line decoder/demultiplexer is designed to be used in high-performance memory-decoding and data-routing applications that require very short propagation-delay times. In high-performance memory systems, this decoder can be used to minimize the effects of system decoding. When employed with high-speed memories utilizing a fast enable circuit, the delay times of this decoder and the enable time of the memory usually are less than the typical access time of the memory. This means that the effective system delay introduced by the decoder is negligible.

The conditions at the binary-select inputs and the three enable inputs select one of eight output lines. Two active-low and one active-high enable inputs reduce the need for external gates or inverters when expanding. A 24-line decoder can be implemented without external inverters and a 32-line decoder requires only one inverter. An enable input can be used as a data input for demultiplexing applications.

### ORDERING INFORMATION†

T <sub>A</sub>	PACKAGE‡		ORDERABLE PART NUMBER	TOP-SIDE MARKING
–40°C to 125°C	SOIC – D	Tape and reel	SN74AHCT138QDRQ1	AHCT138Q
	TSSOP – PW	Tape and reel	SN74AHCT138QPWRQ1	HB138Q

† For the most current package and ordering information, see the Package Option Addendum at the end of this document, or see the TI web site at <http://www.ti.com>.

‡ Package drawings, thermal data, and symbolization are available at <http://www.ti.com/packaging>.



Please be aware that an important notice concerning availability, standard warranty, and use in critical applications of Texas Instruments semiconductor products and disclaimers thereto appears at the end of this data sheet.

EPIC is a trademark of Texas Instruments.

PRODUCTION DATA information is current as of publication date. Products conform to specifications per the terms of Texas Instruments standard warranty. Production processing does not necessarily include testing of all parameters.



POST OFFICE BOX 655303 • DALLAS, TEXAS 75265

Copyright © 2008, Texas Instruments Incorporated

# SN74AHCT138Q-Q1

## 3-LINE TO 8-LINE DECODER/DEMULTIPLEXER

SGDS022A – FEBRUARY 2002 – REVISED APRIL 2008

FUNCTION TABLE

ENABLE INPUTS			SELECT INPUTS			OUTPUTS							
G1	$\overline{G2A}$	$\overline{G2B}$	C	B	A	Y0	Y1	Y2	Y3	Y4	Y5	Y6	Y7
X	H	X	X	X	X	H	H	H	H	H	H	H	H
X	X	H	X	X	X	H	H	H	H	H	H	H	H
L	X	X	X	X	X	H	H	H	H	H	H	H	H
H	L	L	L	L	L	L	H	H	H	H	H	H	H
H	L	L	L	L	H	H	L	H	H	H	H	H	H
H	L	L	L	H	L	H	H	L	H	H	H	H	H
H	L	L	H	L	L	H	H	H	H	L	H	H	H
H	L	L	H	L	H	H	H	H	H	H	L	H	H
H	L	L	H	H	L	H	H	H	H	H	H	L	H
H	L	L	H	H	H	H	H	H	H	H	H	H	L

### logic symbols (alternatives)†

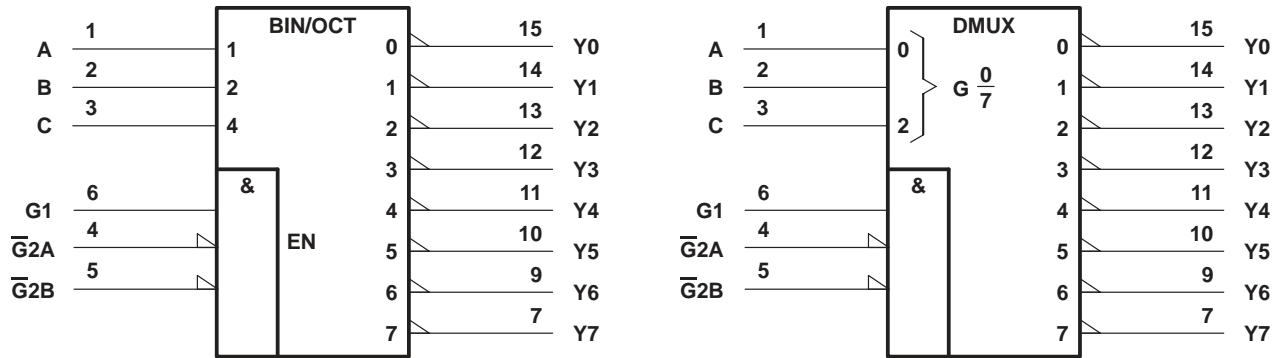

† These symbols are in accordance with ANSI/IEEE Std 91-1984 and IEC Publication 617-12.



# SN74AHCT138Q-Q1

## 3-LINE TO 8-LINE DECODER/DEMULTIPLEXER

SGDS022A – FEBRUARY 2002 – REVISED APRIL 2008

### recommended operating conditions (see Note 3)

		MIN	MAX	UNIT
V <sub>CC</sub>	Supply voltage	4.5	5.5	V
V <sub>IH</sub>	High-level input voltage	2		V
V <sub>IL</sub>	Low-level input voltage		0.8	V
V <sub>I</sub>	Input voltage	0	5.5	V
V <sub>O</sub>	Output voltage	0	V <sub>CC</sub>	V
I <sub>OH</sub>	High-level output current		-8	mA
I <sub>OL</sub>	Low-level output current		8	mA
Δt/Δv	Input transition rise or fall rate		20	ns/V
T <sub>A</sub>	Operating free-air temperature	-40	125	°C

NOTE 3: All unused inputs of the device must be held at V<sub>CC</sub> or GND to ensure proper device operation. Refer to the TI application report, *Implications of Slow or Floating CMOS Inputs*, literature number SCBA004.

### electrical characteristics over recommended operating free-air temperature range (unless otherwise noted)

PARAMETER	TEST CONDITIONS	V <sub>CC</sub>	T <sub>A</sub> = 25°C			MIN	MAX	UNIT
			MIN	TYP	MAX			
V <sub>OH</sub>	I <sub>OH</sub> = -50 μA	4.5 V	4.4	4.5		4.4		V
	I <sub>OH</sub> = -8 mA		3.94			3.8		
V <sub>OL</sub>	I <sub>OL</sub> = 50 μA	4.5 V			0.1		0.1	V
	I <sub>OL</sub> = 8 mA				0.36		0.5	
I <sub>I</sub>	V <sub>I</sub> = 5.5 V or GND	0 V to 5.5 V			±0.1		±1	μA
I <sub>CC</sub>	V <sub>I</sub> = V <sub>CC</sub> or GND, I <sub>O</sub> = 0	5.5 V			4		40	μA
ΔI <sub>CC</sub> †	One input at 3.4 V, Other inputs at V <sub>CC</sub> or GND	5.5 V			1.35		1.5	mA
C <sub>i</sub>	V <sub>I</sub> = V <sub>CC</sub> or GND	5 V		2	10			pF

† This is the increase in supply current for each input at one of the specified TTL voltage levels rather than 0 V or V<sub>CC</sub>.

### switching characteristics over recommended operating free-air temperature range, V<sub>CC</sub> = 5 V ± 0.5 V (unless otherwise noted) (see Figure 1)

PARAMETER	FROM (INPUT)	TO (OUTPUT)	LOAD CAPACITANCE	T <sub>A</sub> = 25°C			MIN	MAX	UNIT
				MIN	TYP	MAX			
t <sub>PLH</sub>	A, B, C	Any Y	C <sub>L</sub> = 15 pF	7.6	10.4		1	12	ns
t <sub>PHL</sub>				7.6	10.4		1	12	
t <sub>PLH</sub>	G1	Any Y	C <sub>L</sub> = 15 pF	6.6	9.1		1	10.5	ns
t <sub>PHL</sub>				6.6	9.1		1	10.5	
t <sub>PLH</sub>	$\overline{G}2A, \overline{G}2B$	Any Y	C <sub>L</sub> = 15 pF	7	9.6		1	11	ns
t <sub>PHL</sub>				7	9.6		1	11	
t <sub>PLH</sub>	A, B, C	Any Y	C <sub>L</sub> = 50 pF	8.1	11.4		1	13	ns
t <sub>PHL</sub>				8.1	11.4		1	13	
t <sub>PLH</sub>	G1	Any Y	C <sub>L</sub> = 50 pF	7.1	10.1		1	11.5	ns
t <sub>PHL</sub>				7.1	10.1		1	11.5	
t <sub>PLH</sub>	$\overline{G}2A, \overline{G}2B$	Any Y	C <sub>L</sub> = 50 pF	7.5	10.6		1	12	ns
t <sub>PHL</sub>				7.5	10.6		1	12	



# SN74AHCT138Q-Q1

## 3-LINE TO 8-LINE DECODER/DEMULTIPLEXER

SGDS022A – FEBRUARY 2002 – REVISED APRIL 2008

operating characteristics,  $V_{CC} = 5\text{ V}$ ,  $T_A = 25^\circ\text{C}$

PARAMETER	TEST CONDITIONS	TYP	UNIT
$C_{pd}$ Power dissipation capacitance	No load, $f = 1\text{ MHz}$	14	pF

### PARAMETER MEASUREMENT INFORMATION

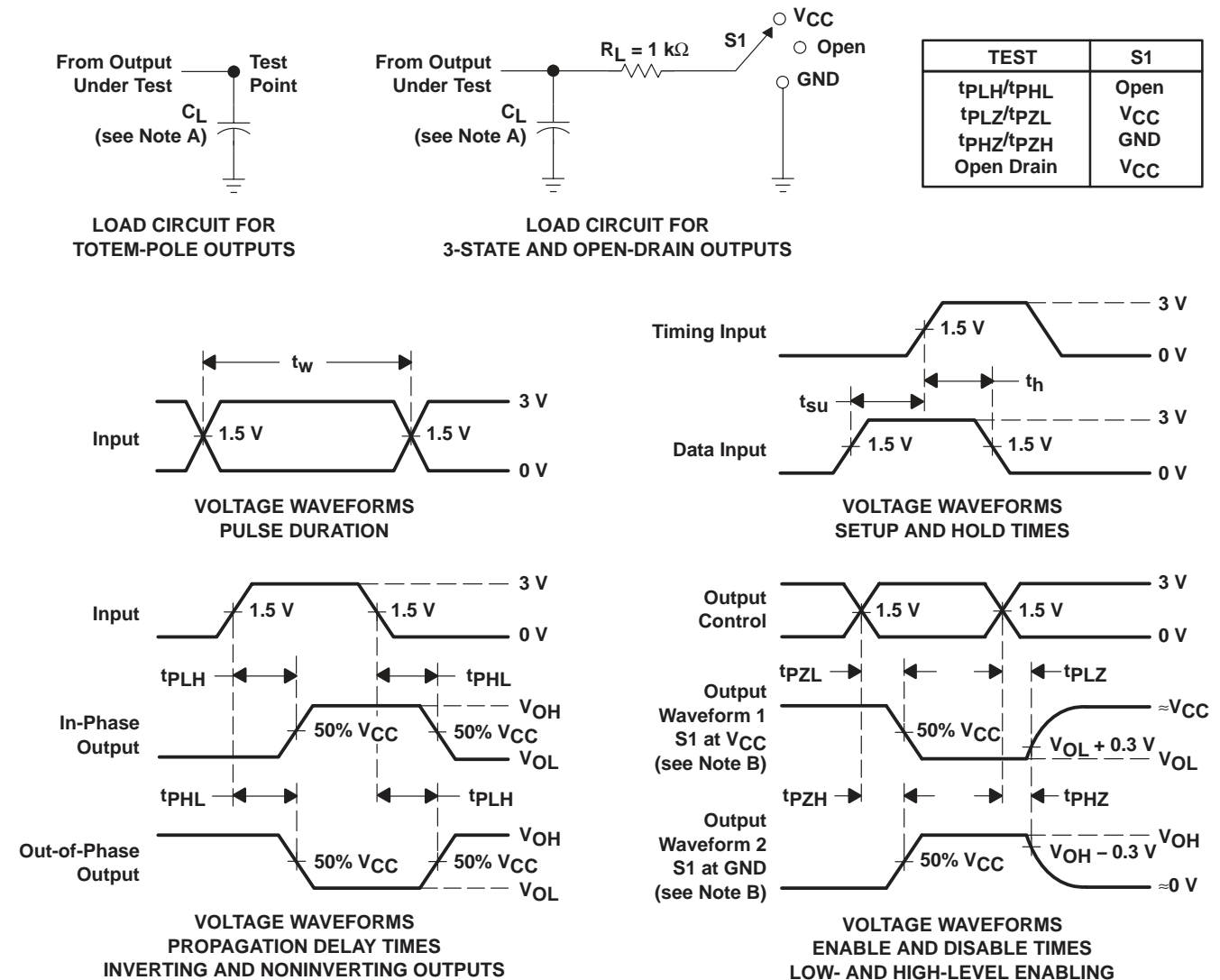

- NOTES:
- A.  $C_L$  includes probe and jig capacitance.
  - B. Waveform 1 is for an output with internal conditions such that the output is low except when disabled by the output control. Waveform 2 is for an output with internal conditions such that the output is high except when disabled by the output control.
  - C. All input pulses are supplied by generators having the following characteristics:  $PRR \leq 1\text{ MHz}$ ,  $Z_O = 50\ \Omega$ ,  $t_r \leq 3\text{ ns}$ ,  $t_f \leq 3\text{ ns}$ .
  - D. The outputs are measured one at a time with one input transition per measurement.

Figure 1. Load Circuit and Voltage Waveforms

# SN74AHCT138Q-Q1

## 3-LINE TO 8-LINE DECODER/DEMULTIPLEXER

SGDS022A – FEBRUARY 2002 – REVISED APRIL 2008

### APPLICATION INFORMATION

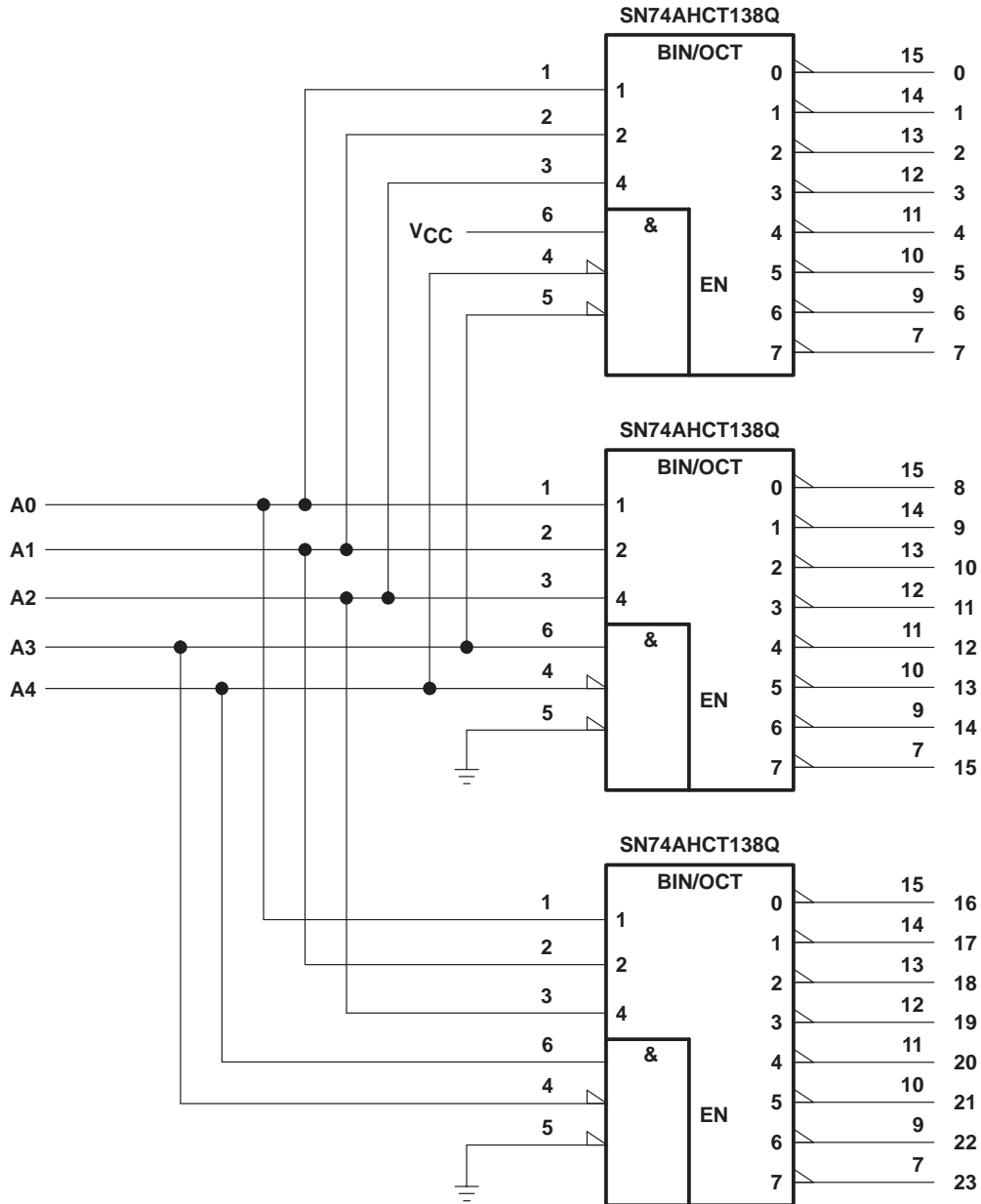

Figure 2. 24-Bit Decoding Scheme

# SN74AHCT138Q-Q1 3-LINE TO 8-LINE DECODER/DEMULTIPLEXER

SGDS022A – FEBRUARY 2002 – REVISED APRIL 2008

## APPLICATION INFORMATION

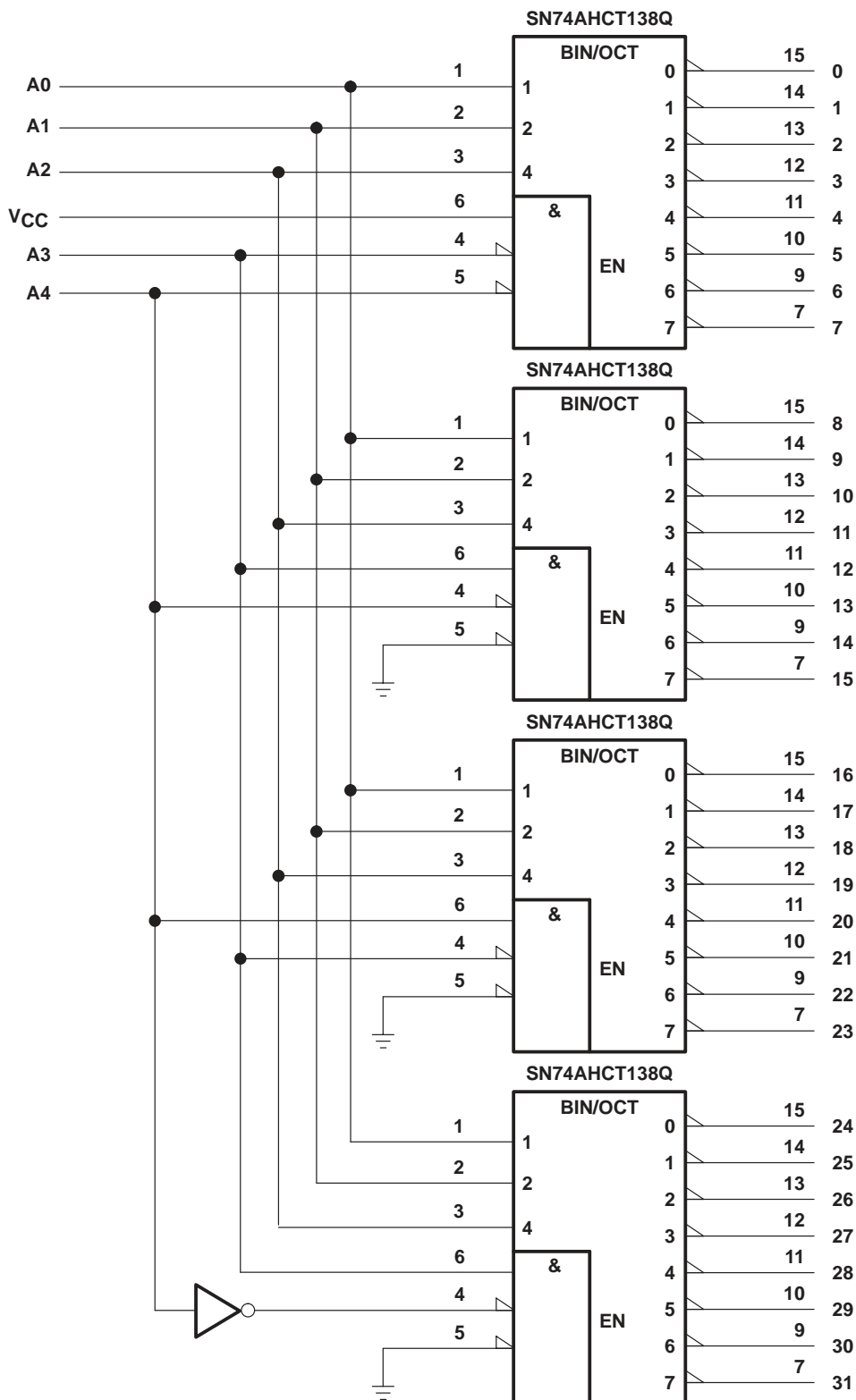

Figure 3. 32-Bit Decoding Scheme

**PACKAGING INFORMATION**

Orderable Device	Status (1)	Package Type	Package Drawing	Pins	Package Qty	Eco Plan (2)	Lead finish/ Ball material (6)	MSL Peak Temp (3)	Op Temp (°C)	Device Marking (4/5)	Samples
CAHCT138QPWRG4Q1	ACTIVE	TSSOP	PW	16	2000	RoHS & Green	NIPDAU	Level-1-260C-UNLIM	-40 to 125	HB138Q	<a href="#">Samples</a>
SN74AHCT138QDRQ1	ACTIVE	SOIC	D	16	2500	RoHS & Green	NIPDAU	Level-1-260C-UNLIM	-40 to 125	AHCT138Q	<a href="#">Samples</a>

(1) The marketing status values are defined as follows:

**ACTIVE:** Product device recommended for new designs.

**LIFEBUY:** TI has announced that the device will be discontinued, and a lifetime-buy period is in effect.

**NRND:** Not recommended for new designs. Device is in production to support existing customers, but TI does not recommend using this part in a new design.

**PREVIEW:** Device has been announced but is not in production. Samples may or may not be available.

**OBSOLETE:** TI has discontinued the production of the device.

(2) **RoHS:** TI defines "RoHS" to mean semiconductor products that are compliant with the current EU RoHS requirements for all 10 RoHS substances, including the requirement that RoHS substance do not exceed 0.1% by weight in homogeneous materials. Where designed to be soldered at high temperatures, "RoHS" products are suitable for use in specified lead-free processes. TI may reference these types of products as "Pb-Free".

**RoHS Exempt:** TI defines "RoHS Exempt" to mean products that contain lead but are compliant with EU RoHS pursuant to a specific EU RoHS exemption.

**Green:** TI defines "Green" to mean the content of Chlorine (Cl) and Bromine (Br) based flame retardants meet JS709B low halogen requirements of <=1000ppm threshold. Antimony trioxide based flame retardants must also meet the <=1000ppm threshold requirement.

(3) MSL, Peak Temp. - The Moisture Sensitivity Level rating according to the JEDEC industry standard classifications, and peak solder temperature.

(4) There may be additional marking, which relates to the logo, the lot trace code information, or the environmental category on the device.

(5) Multiple Device Markings will be inside parentheses. Only one Device Marking contained in parentheses and separated by a "~" will appear on a device. If a line is indented then it is a continuation of the previous line and the two combined represent the entire Device Marking for that device.

(6) Lead finish/Ball material - Orderable Devices may have multiple material finish options. Finish options are separated by a vertical ruled line. Lead finish/Ball material values may wrap to two lines if the finish value exceeds the maximum column width.

**Important Information and Disclaimer:**The information provided on this page represents TI's knowledge and belief as of the date that it is provided. TI bases its knowledge and belief on information provided by third parties, and makes no representation or warranty as to the accuracy of such information. Efforts are underway to better integrate information from third parties. TI has taken and continues to take reasonable steps to provide representative and accurate information but may not have conducted destructive testing or chemical analysis on incoming materials and chemicals. TI and TI suppliers consider certain information to be proprietary, and thus CAS numbers and other limited information may not be available for release.

In no event shall TI's liability arising out of such information exceed the total purchase price of the TI part(s) at issue in this document sold by TI to Customer on an annual basis.





**TAPE AND REEL INFORMATION**

**QUADRANT ASSIGNMENTS FOR PIN 1 ORIENTATION IN TAPE**

\*All dimensions are nominal

Device	Package Type	Package Drawing	Pins	SPQ	Reel Diameter (mm)	Reel Width W1 (mm)	A0 (mm)	B0 (mm)	K0 (mm)	P1 (mm)	W (mm)	Pin1 Quadrant
CAHCT138QPWRG4Q1	TSSOP	PW	16	2000	330.0	12.4	6.9	5.6	1.6	8.0	12.0	Q1

**TAPE AND REEL BOX DIMENSIONS**



\*All dimensions are nominal

Device	Package Type	Package Drawing	Pins	SPQ	Length (mm)	Width (mm)	Height (mm)
CAHCT138QPWRG4Q1	TSSOP	PW	16	2000	356.0	356.0	35.0

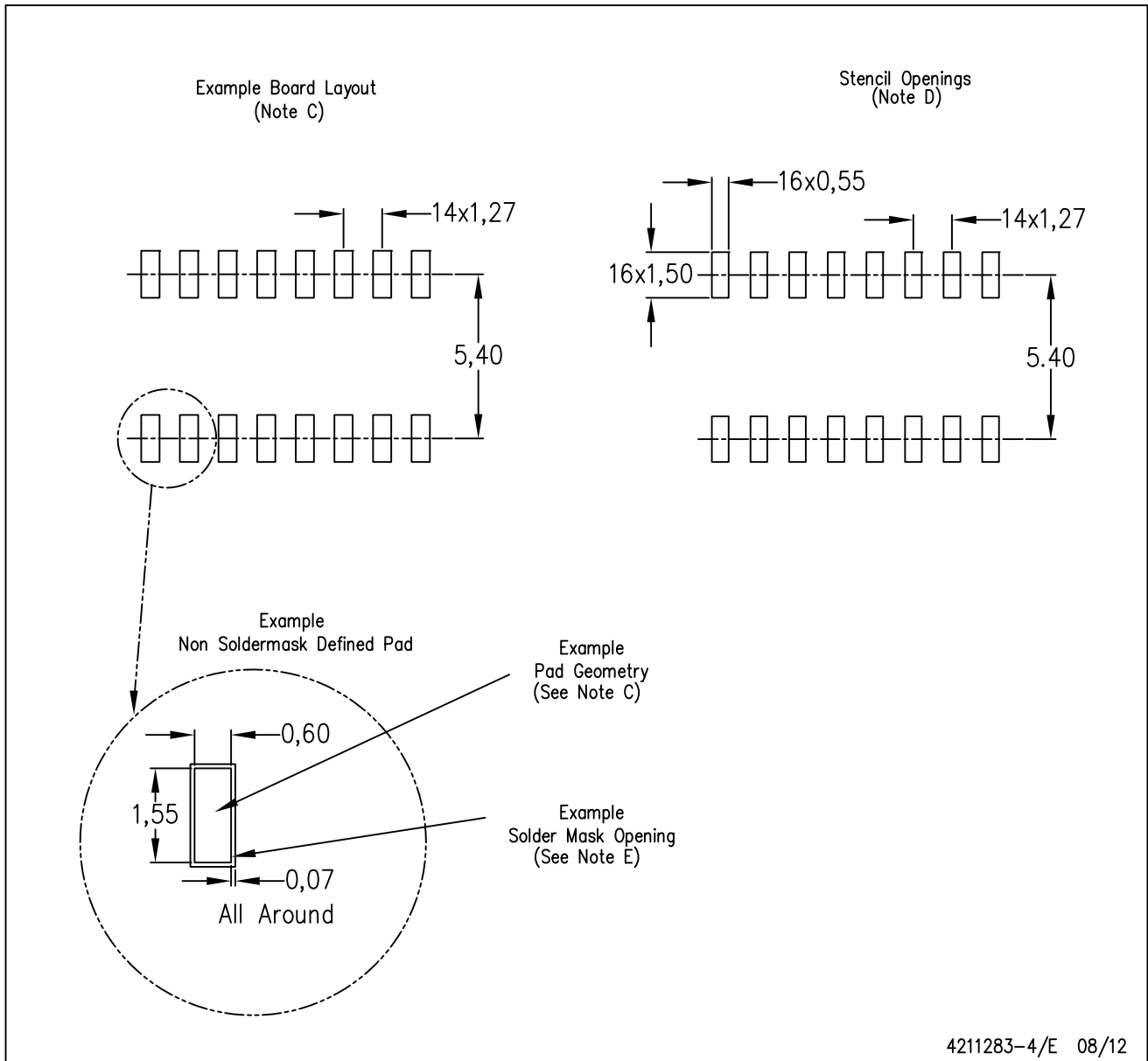

D (R-PDSO-G16)

PLASTIC SMALL OUTLINE



- NOTES:
- All linear dimensions are in millimeters.
  - This drawing is subject to change without notice.
  - Publication IPC-7351 is recommended for alternate designs.
  - Laser cutting apertures with trapezoidal walls and also rounding corners will offer better paste release. Customers should contact their board assembly site for stencil design recommendations. Refer to IPC-7525 for other stencil recommendations.
  - Customers should contact their board fabrication site for solder mask tolerances between and around signal pads.



4220204/A 02/2017

NOTES:

1. All linear dimensions are in millimeters. Any dimensions in parenthesis are for reference only. Dimensioning and tolerancing per ASME Y14.5M.
2. This drawing is subject to change without notice.
3. This dimension does not include mold flash, protrusions, or gate burrs. Mold flash, protrusions, or gate burrs shall not exceed 0.15 mm per side.
4. This dimension does not include interlead flash. Interlead flash shall not exceed 0.25 mm per side.
5. Reference JEDEC registration MO-153.

# EXAMPLE BOARD LAYOUT

PW0016A

TSSOP - 1.2 mm max height

SMALL OUTLINE PACKAGE



LAND PATTERN EXAMPLE  
EXPOSED METAL SHOWN  
SCALE: 10X



4220204/A 02/2017

NOTES: (continued)

- 6. Publication IPC-7351 may have alternate designs.
- 7. Solder mask tolerances between and around signal pads can vary based on board fabrication site.

# EXAMPLE STENCIL DESIGN

PW0016A

TSSOP - 1.2 mm max height

SMALL OUTLINE PACKAGE

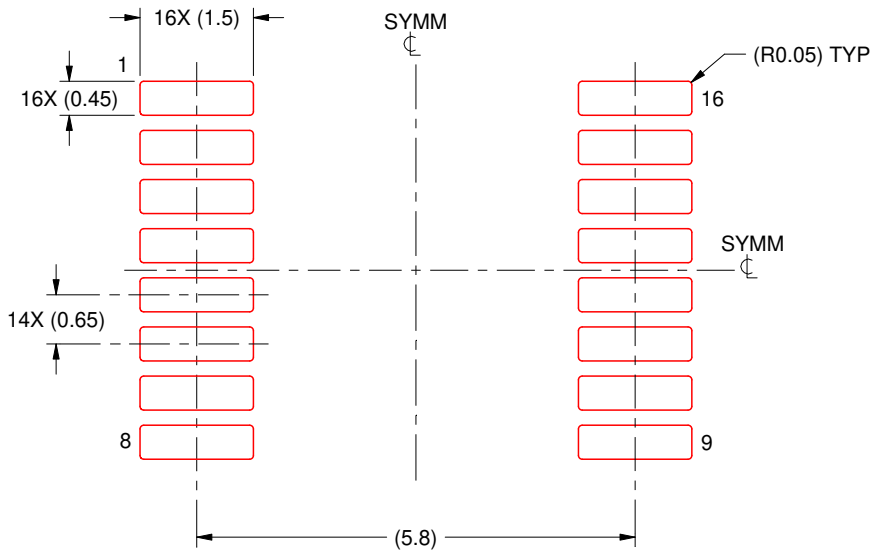

SOLDER PASTE EXAMPLE  
BASED ON 0.125 mm THICK STENCIL  
SCALE: 10X

4220204/A 02/2017

NOTES: (continued)

8. Laser cutting apertures with trapezoidal walls and rounded corners may offer better paste release. IPC-7525 may have alternate design recommendations.
9. Board assembly site may have different recommendations for stencil design.



## IMPORTANT NOTICE AND DISCLAIMER

TI PROVIDES TECHNICAL AND RELIABILITY DATA (INCLUDING DATA SHEETS), DESIGN RESOURCES (INCLUDING REFERENCE DESIGNS), APPLICATION OR OTHER DESIGN ADVICE, WEB TOOLS, SAFETY INFORMATION, AND OTHER RESOURCES "AS IS" AND WITH ALL FAULTS, AND DISCLAIMS ALL WARRANTIES, EXPRESS AND IMPLIED, INCLUDING WITHOUT LIMITATION ANY IMPLIED WARRANTIES OF MERCHANTABILITY, FITNESS FOR A PARTICULAR PURPOSE OR NON-INFRINGEMENT OF THIRD PARTY INTELLECTUAL PROPERTY RIGHTS.

These resources are intended for skilled developers designing with TI products. You are solely responsible for (1) selecting the appropriate TI products for your application, (2) designing, validating and testing your application, and (3) ensuring your application meets applicable standards, and any other safety, security, regulatory or other requirements.

These resources are subject to change without notice. TI grants you permission to use these resources only for development of an application that uses the TI products described in the resource. Other reproduction and display of these resources is prohibited. No license is granted to any other TI intellectual property right or to any third party intellectual property right. TI disclaims responsibility for, and you will fully indemnify TI and its representatives against, any claims, damages, costs, losses, and liabilities arising out of your use of these resources.

TI's products are provided subject to [TI's Terms of Sale](#) or other applicable terms available either on [ti.com](http://ti.com) or provided in conjunction with such TI products. TI's provision of these resources does not expand or otherwise alter TI's applicable warranties or warranty disclaimers for TI products.

TI objects to and rejects any additional or different terms you may have proposed.

Mailing Address: Texas Instruments, Post Office Box 655303, Dallas, Texas 75265  
Copyright © 2022, Texas Instruments Incorporated