

Silicon PIN Photodiode



LINKS TO ADDITIONAL RESOURCES



DESCRIPTION

VEMD8081 is a high speed and high sensitive PIN photodiode with enhanced sensitivity for visible light. It is a low profile surface-mount device (SMD) including the chip with a 5.4 mm² sensitive area detecting visible and near infrared radiation.

FEATURES

- Package type: surface-mount
- Package form: top view
- Dimensions (L x W x H in mm): 4.8 x 2.5 x 0.48
- Radiant sensitive area (in mm²): 5.4
- 0.48 mm low profile package
- Enhanced sensitivity for visible light
- Suitable for visible and near infrared radiation
- Angle of half sensitivity: $\phi = \pm 65^\circ$
- Floor life: 168 h, MSL 3, according to J-STD-020
- Material categorization: for definitions of compliance please see www.vishay.com/doc?99912



APPLICATIONS

- High speed photo detector
- Wearables

PRODUCT SUMMARY

| COMPONENT | I_{ra} (μA) at $E_e = 1.0 \text{ mW/cm}^2$, $\lambda = 850 \text{ nm}$, $V_R = 5.0 \text{ V}$ | ϕ ($^\circ$) | $\lambda_{0.1}$ (nm) |
|-----------|--|------------------------|-------------------------|
| VEMD8081 | 33 | ± 65 | 350 to 1100 |

Note

- Test conditions see table "Basic Characteristics"

ORDERING INFORMATION

| ORDERING CODE | PACKAGING | REMARKS | PACKAGE FORM |
|---------------|---------------|------------------------------|--------------|
| VEMD8081 | Tape and reel | MOQ: 5000 pcs, 5000 pcs/reel | Top view |

Note

- MOQ: minimum order quantity

ABSOLUTE MAXIMUM RATINGS ($T_{amb} = 25^\circ C$, unless otherwise specified)

| PARAMETER | TEST CONDITION | SYMBOL | VALUE | UNIT |
|-----------------------------|--|-------------|------------|------------|
| Reverse voltage | | V_R | 20 | V |
| Operating temperature range | | T_{amb} | -40 to +85 | $^\circ C$ |
| Storage temperature range | | T_{stg} | -40 to +85 | $^\circ C$ |
| Soldering temperature | According to reflow solder profile Fig. 8 | T_{sd} | 260 | $^\circ C$ |
| ESD safety HBM | $\pm 2000 \text{ V}$, 1.5 k Ω , 100 pF, 3 pulses | ESD_{HBM} | ≥ 2 | kV |

| BASIC CHARACTERISTICS ($T_{amb} = 25\text{ }^{\circ}\text{C}$, unless otherwise specified) | | | | | | |
|---|---|-----------------|------|-------------|------|---------------|
| PARAMETER | TEST CONDITION | SYMBOL | MIN. | TYP. | MAX. | UNIT |
| Forward voltage | $I_F = 50\text{ mA}$ | V_F | - | 2.3 | 3.3 | V |
| Reverse dark current | $V_R = 10\text{ V}, E = 0$ | I_{ro} | - | 0.5 | 10 | nA |
| Diode capacitance | $V_R = 0\text{ V}, f = 1\text{ MHz}, E = 0$ | C_D | - | 50 | - | pF |
| | $V_R = 3\text{ V}, f = 1\text{ MHz}, E = 0$ | C_D | - | 20 | 40 | pF |
| Reverse light current | $E_e = 1\text{ mW/cm}^2, \lambda = 525\text{ nm}, V_R = 5\text{ V}$ | I_{ra} | 15 | 20 | 24 | μA |
| | $E_e = 1\text{ mW/cm}^2, \lambda = 850\text{ nm}, V_R = 5\text{ V}$ | I_{ra} | 29 | 33 | 38 | μA |
| Angle of half sensitivity | | ϕ | - | ± 65 | - | $^{\circ}$ |
| Wavelength of peak sensitivity | | λ_p | - | 840 | - | nm |
| Range of spectral bandwidth | | $\lambda_{0,1}$ | - | 350 to 1100 | - | nm |
| Rise time | $V_R = 10\text{ V}, R_L = 50\ \Omega, \lambda = 830\text{ nm}$ | t_r | - | 110 | - | ns |
| Fall time | $V_R = 10\text{ V}, R_L = 50\ \Omega, \lambda = 830\text{ nm}$ | t_f | - | 110 | - | ns |

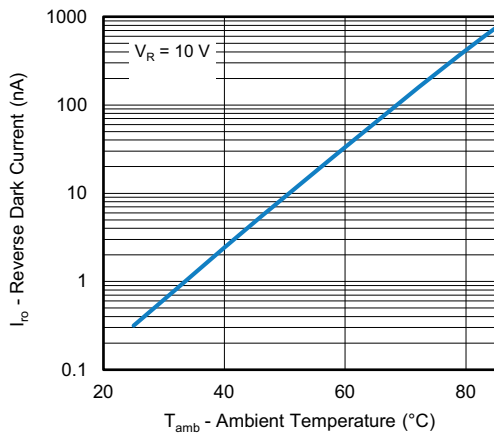
BASIC CHARACTERISTICS ($T_{amb} = 25\text{ }^{\circ}\text{C}$, unless otherwise specified)


Fig. 1 - Reverse Dark Current vs. Ambient Temperature

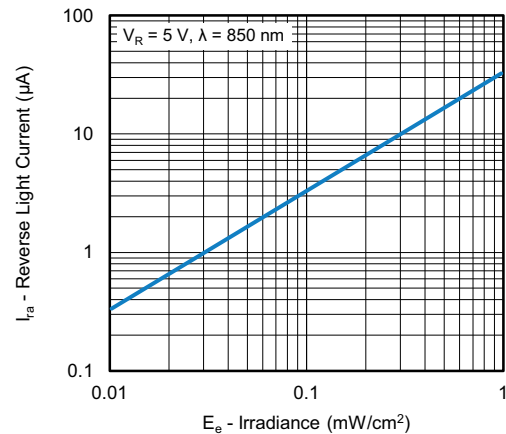


Fig. 3 - Reverse Light Current vs. Irradiance

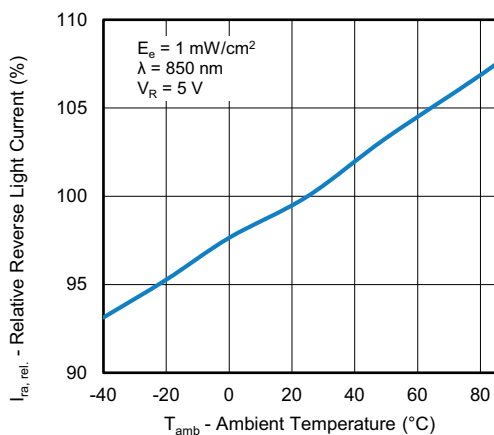


Fig. 2 - Relative Reverse Light Current vs. Ambient Temperature

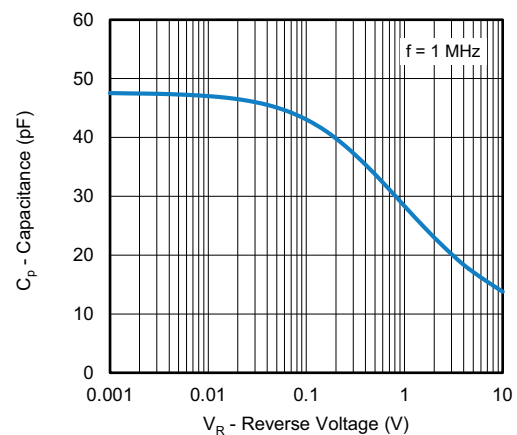


Fig. 4 - Diode Capacitance vs. Reverse Voltage

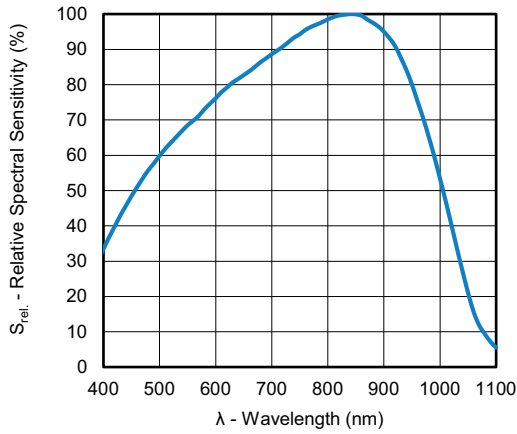


Fig. 5 - Relative Spectral Sensitivity vs. Wavelength

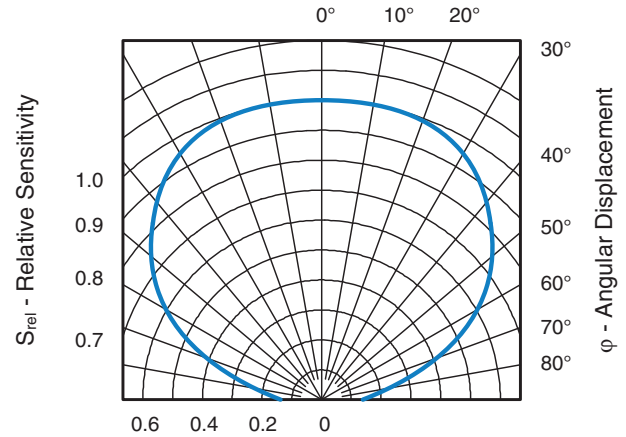
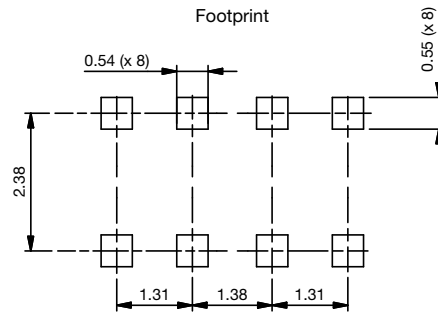
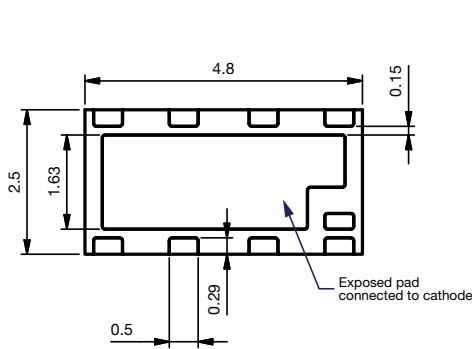
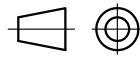
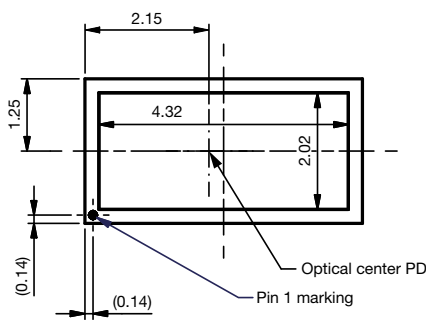
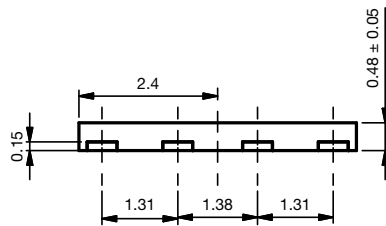


Fig. 6 - Relative Sensitivity vs. Angular Displacement

PACKAGE DIMENSIONS in millimeters

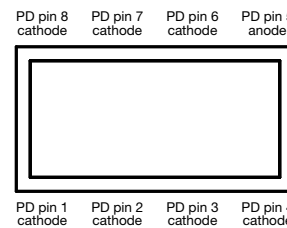


Not indicated tolerances ± 0.1 mm

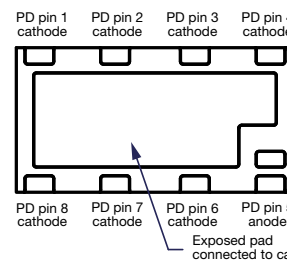


Technical drawings according to DIN specification.

Pinning top view

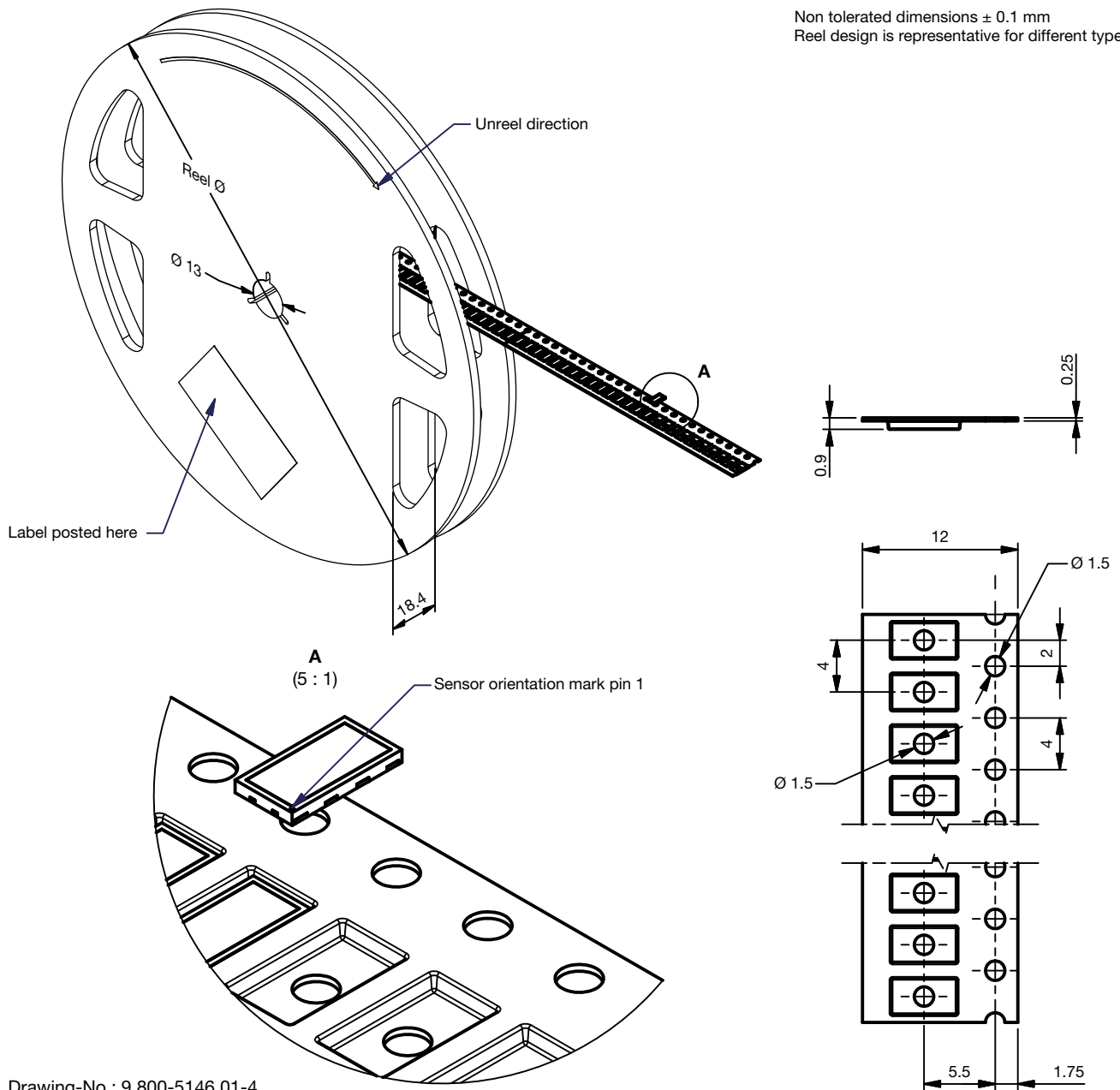


Pinning bottom view



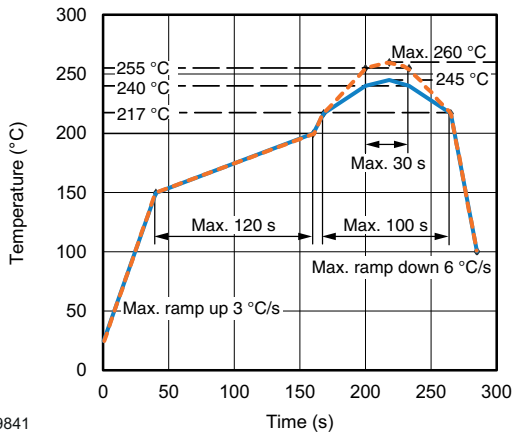
TAPE AND REEL DIMENSIONS in millimeters

Non tolerated dimensions ± 0.1 mm
 Reel design is representative for different types



Drawing-No.: 9.800-5146.01-4
 Issue: 1; 20.04.2018

SOLDER PROFILE



19841

Fig. 7 - Lead (Pb)-free Reflow Solder Profile According to J-STD-020D

DRYPACK

Devices are packed in moisture barrier bags (MBB) to prevent the products from moisture absorption during transportation and storage. Each bag contains a desiccant.

FLOOR LIFE

Time between soldering and removing from MBB must not exceed the time indicated in J-STD-020:

Moisture sensitivity: level 3

Floor life: 168 h

Conditions: $T_{amb} < 30\text{ }^{\circ}\text{C}$, $\text{RH} < 60\%$

DRYING

In case of moisture absorption devices should be baked before soldering. Conditions see J-STD-033D or recommended conditions:

192 h at $40\text{ }^{\circ}\text{C} (+ 5\text{ }^{\circ}\text{C})$, $\text{RH} < 5\%$

or

96 h at $60\text{ }^{\circ}\text{C} (+ 5\text{ }^{\circ}\text{C})$, $\text{RH} < 5\%$



Disclaimer

ALL PRODUCT, PRODUCT SPECIFICATIONS AND DATA ARE SUBJECT TO CHANGE WITHOUT NOTICE TO IMPROVE RELIABILITY, FUNCTION OR DESIGN OR OTHERWISE.

Vishay Intertechnology, Inc., its affiliates, agents, and employees, and all persons acting on its or their behalf (collectively, "Vishay"), disclaim any and all liability for any errors, inaccuracies or incompleteness contained in any datasheet or in any other disclosure relating to any product.

Vishay makes no warranty, representation or guarantee regarding the suitability of the products for any particular purpose or the continuing production of any product. To the maximum extent permitted by applicable law, Vishay disclaims (i) any and all liability arising out of the application or use of any product, (ii) any and all liability, including without limitation special, consequential or incidental damages, and (iii) any and all implied warranties, including warranties of fitness for particular purpose, non-infringement and merchantability.

Statements regarding the suitability of products for certain types of applications are based on Vishay's knowledge of typical requirements that are often placed on Vishay products in generic applications. Such statements are not binding statements about the suitability of products for a particular application. It is the customer's responsibility to validate that a particular product with the properties described in the product specification is suitable for use in a particular application. Parameters provided in datasheets and / or specifications may vary in different applications and performance may vary over time. All operating parameters, including typical parameters, must be validated for each customer application by the customer's technical experts. Product specifications do not expand or otherwise modify Vishay's terms and conditions of purchase, including but not limited to the warranty expressed therein.

Hyperlinks included in this datasheet may direct users to third-party websites. These links are provided as a convenience and for informational purposes only. Inclusion of these hyperlinks does not constitute an endorsement or an approval by Vishay of any of the products, services or opinions of the corporation, organization or individual associated with the third-party website. Vishay disclaims any and all liability and bears no responsibility for the accuracy, legality or content of the third-party website or for that of subsequent links.

Except as expressly indicated in writing, Vishay products are not designed for use in medical, life-saving, or life-sustaining applications or for any other application in which the failure of the Vishay product could result in personal injury or death. Customers using or selling Vishay products not expressly indicated for use in such applications do so at their own risk. Please contact authorized Vishay personnel to obtain written terms and conditions regarding products designed for such applications.

No license, express or implied, by estoppel or otherwise, to any intellectual property rights is granted by this document or by any conduct of Vishay. Product names and markings noted herein may be trademarks of their respective owners.