

## Features

- GaN on SiC D-Mode Transistor Technology
- Unmatched, Ideal for Pulsed Applications
- 50 V Typical Bias, Class AB
- Common-Source Configuration
- Thermally-Enhanced 3 x 6 mm 14-Lead DFN
- MTTF = 600 years ( $T_J < 200^\circ\text{C}$ )
- Halogen-Free “Green” Mold Compound
- RoHS\* Compliant and 260°C Reflow Compatible
- MSL-1

## Description

The MAGX-000035-09000P is a GaN on SiC unmatched power device offering the widest RF frequency capability, most reliable high voltage operation, lowest overall power transistor size, cost and weight in a “TRUE SMT” plastic-packaging technology.

Use of an internal stress buffer technology allows reliable operation at junction temperatures up to 200°C. The small package size and excellent RF performance make it an ideal replacement for costly flanged or metal-backed module components.

## Ordering Information<sup>1,2</sup>

| Part Number        | Package        |
|--------------------|----------------|
| MAGX-000035-09000P | Bulk Packaging |
| MAGX-000035-0900TP | 100 Piece Reel |
| MAGX-000035-PB3PPR | Sample Board   |

1. Reference Application Note M513 for reel size information.
2. When ordering sample evaluation boards, choose a standard frequency range indicated on page 4/5 or specify a desired custom range. Custom requests may increase lead times.

\* Restrictions on Hazardous Substances, European Union Directive 2002/95/EC.



## Functional Schematic

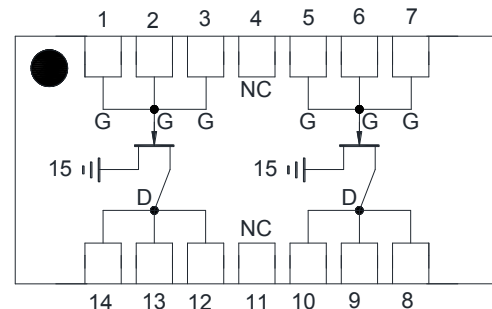

## Pin Configuration<sup>3</sup>

| Pin No. | Function         | Pin No. | Function            |
|---------|------------------|---------|---------------------|
| 1       | $V_{GG}/RF_{IN}$ | 8       | $V_{DD}/RF_{OUT}$   |
| 2       | $V_{GG}/RF_{IN}$ | 9       | $V_{DD}/RF_{OUT}$   |
| 3       | $V_{GG}/RF_{IN}$ | 10      | $V_{DD}/RF_{OUT}$   |
| 4       | No Connection    | 11      | No Connection       |
| 5       | $V_{GG}/RF_{IN}$ | 12      | $V_{DD}/RF_{OUT}$   |
| 6       | $V_{GG}/RF_{IN}$ | 13      | $V_{DD}/RF_{OUT}$   |
| 7       | $V_{GG}/RF_{IN}$ | 14      | $V_{DD}/RF_{OUT}$   |
|         |                  | 15      | Paddle <sup>4</sup> |

3. MACOM recommends connecting unused package pins to ground.
4. The exposed pad centered on the package bottom must be connected to RF and DC ground.

## GaN Wideband 90 W Pulsed Transistor in Plastic Package DC - 3.5 GHz

Rev. V3

### Typical Performance<sup>5</sup>: $V_{DD} = 50\text{ V}$ , $I_{DQ} = 200\text{ mA}$ , $T_A = 25^\circ\text{C}$

| Parameter                     | 30 MHz | 1 GHz | 2.5 GHz | 3.5 GHz | Units |
|-------------------------------|--------|-------|---------|---------|-------|
| Gain                          | 25     | 21    | 15      | 13      | dB    |
| Saturated Power ( $P_{SAT}$ ) | 100    | 98    | 90      | 85      | W     |
| Power Gain at $P_{SAT}$       | 22     | 20    | 15      | 11      | dB    |
| PAE @ $P_{SAT}$               | 75     | 65    | 55      | 52      | %     |

5. Typical RF performance measured in M/A-COM Technology Solutions RF evaluation boards. See recommended tuning solutions on pages 4 and 5.

### Electrical Specifications: Freq. = 1.6 GHz, $T_A = 25^\circ\text{C}$ , $V_{DD} = +50\text{ V}$ , $Z_0 = 50\ \Omega$

| Parameter   | Test Conditions                                   | Symbol    | Min. | Typ. | Max. | Units |
|---|---|-----------|------|------|------|-------|
| <b>RF FUNCTIONAL TESTS</b>  |   |           |      |      |      |       |
| CW Output Power (P2.5 dB)   | $V_{DD} = 28\text{ V}$ , $I_{DQ} = 200\text{ mA}$ | $P_{OUT}$ | -    | 14   | -    | W     |
| Pulsed Output Power (P2.5 dB)<br>100 $\mu\text{s}$ and 10% Duty Cycle | $V_{DD} = 50\text{ V}$ , $I_{DQ} = 200\text{ mA}$ | $P_{OUT}$ | 75   | 95   | -    | W     |
| Pulsed Power Gain (P2.5 dB)   | $V_{DD} = 50\text{ V}$ , $I_{DQ} = 200\text{ mA}$ | $G_P$     | 16   | 17.5 | -    | dB    |
| Pulsed Drain Efficiency (P2.5 dB)                                     | $V_{DD} = 50\text{ V}$ , $I_{DQ} = 200\text{ mA}$ | $\eta_D$  | 55   | 65   | -    | %     |
| Load Mismatch Stability (P2.5 dB)                                     | $V_{DD} = 50\text{ V}$ , $I_{DQ} = 200\text{ mA}$ | VSWR-S    | -    | 5:1  | -    | -     |
| Load Mismatch Tolerance (P2.5 dB)                                     | $V_{DD} = 50\text{ V}$ , $I_{DQ} = 200\text{ mA}$ | VSWR-T    | -    | 10:1 | -    | -     |

### Electrical Characteristics: $T_A = 25^\circ\text{C}$

| Parameter                      | Test Conditions  | Symbol       | Min. | Typ. | Max. | Units |
|--------------------------------|--|--------------|------|------|------|-------|
| <b>DC CHARACTERISTICS</b>      |  |              |      |      |      |       |
| Drain-Source Leakage Current   | $V_{GS} = -8\text{ V}$ , $V_{DS} = 175\text{ V}$                     | $I_{DS}$     | -    | -    | 6.0  | mA    |
| Gate Threshold Voltage         | $V_{DS} = 5\text{ V}$ , $I_D = 6\text{ mA}$                          | $V_{GS(th)}$ | -5   | -3   | -2   | V     |
| Forward Transconductance       | $V_{DS} = 5\text{ V}$ , $I_D = 3000\text{ mA}$                       | $G_M$        | 1.1  | -    | -    | S     |
| <b>DYNAMIC CHARACTERISTICS</b> |  |              |      |      |      |       |
| Input Capacitance              | $V_{DS} = 0\text{ V}$ , $V_{GS} = -8\text{ V}$ , $F = 1\text{ MHz}$  | $C_{ISS}$    | -    | 22   | -    | pF    |
| Output Capacitance             | $V_{DS} = 50\text{ V}$ , $V_{GS} = -8\text{ V}$ , $F = 1\text{ MHz}$ | $C_{OSS}$    | -    | 9.8  | -    | pF    |
| Reverse Transfer Capacitance   | $V_{DS} = 50\text{ V}$ , $V_{GS} = -8\text{ V}$ , $F = 1\text{ MHz}$ | $C_{RSS}$    | -    | 0.9  | -    | pF    |

2

M/A-COM Technology Solutions Inc. (MACOM) and its affiliates reserve the right to make changes to the product(s) or information contained herein without notice. Visit [www.macomtech.com](http://www.macomtech.com) for additional data sheets and product information.

Absolute Maximum Ratings <sup>6,7,8,9,10</sup>

| Parameter                                      | Absolute Max.                     |
|--|-----------------------------------|
| Input Power                                    | $P_{OUT} - G_P + 2.5 \text{ dBm}$ |
| Drain Supply Voltage, $V_{DD}$                 | +65 V                             |
| Gate Supply Voltage, $V_{GG}$                  | -8 V to 0 V                       |
| Supply Current, $I_{DD}$                       | 4500 mA                           |
| Power Dissipation, CW @ 85°C                   | 27 W                              |
| Power Dissipation ( $P_{AVG}$ ), Pulsed @ 85°C | 85 W                              |
| Junction Temperature <sup>11</sup>             | 200°C                             |
| Operating Temperature                          | -40°C to +95°C                    |
| Storage Temperature                            | -65°C to +150°C                   |

6. Exceeding any one or combination of these limits may cause permanent damage to this device.
7. M/A-COM Technology Solutions does not recommend sustained operation near these survivability limits.
8. For saturated performance it is recommended that the sum of  $(3 * V_{DD} + \text{abs}(V_{GG})) \leq 175 \text{ V}$ .
9. CW operation at  $V_{DD}$  voltages above 28 V is not recommended.
10. Operating at nominal conditions with  $T_J \leq 200^\circ\text{C}$  will ensure  $\text{MTTF} > 1 \times 10^6$  hours. Junction temperature directly affects device MTTF and should be kept as low as possible to maximize lifetime.
11. Junction Temperature ( $T_J$ ) =  $T_C + \Theta_{JC} * ((V * I) - (P_{OUT} - P_{IN}))$

Typical CW thermal resistance ( $\Theta_{JC}$ ) = 5.69°C/W

a) For  $T_C = 79^\circ\text{C}$ ,

$T_J = 200^\circ\text{C}$  @ 28 V, 1224 mA,  $P_{OUT} = 15 \text{ W}$ ,  $P_{IN} = 0.25 \text{ W}$

Typical transient thermal resistances:

b) 300  $\mu\text{s}$  pulse, 10% duty cycle,  $\Theta_{JC} = 0.96^\circ\text{C/W}$

For  $T_C = 79^\circ\text{C}$ ,

$T_J = 131^\circ\text{C}$  @ 50 V, 2500 mA,  $P_{OUT} = 74 \text{ W}$ ,  $P_{IN} = 2 \text{ W}$

c) 1 ms pulse, 10% duty cycle,  $\Theta_{JC} = 1.38^\circ\text{C/W}$

For  $T_C = 80^\circ\text{C}$ ,

$T_J = 173^\circ\text{C}$  @ 50 V, 2780 mA,  $P_{OUT} = 74 \text{ W}$ ,  $P_{IN} = 2 \text{ W}$

d) 1 ms pulse, 10% duty cycle,  $\Theta_{JC} = 1.35^\circ\text{C/W}$

For  $T_C = 80^\circ\text{C}$ ,

$T_J = 173^\circ\text{C}$  @ 50 V, 3160 mA,  $P_{OUT} = 93 \text{ W}$ ,  $P_{IN} = 4 \text{ W}$

## Evaluation Board Details and Recommended Tuning Solutions

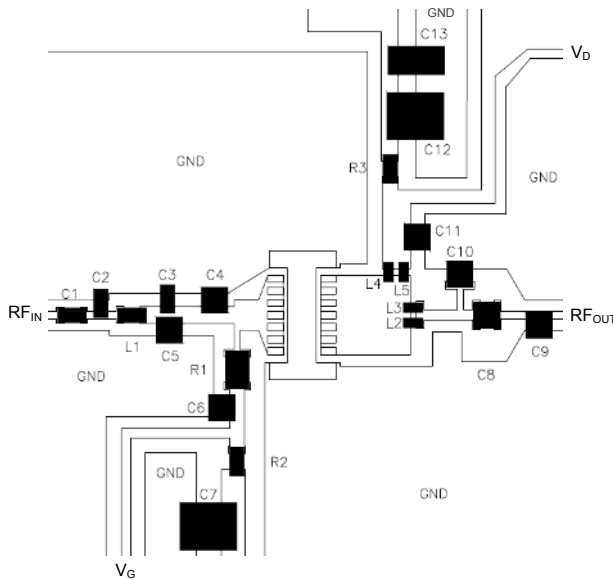

Parts measured on evaluation board (8-mils thick RO4003C). Electrical and thermal ground is provided using copper-filled via hole array (not pictured), and evaluation board is mounted to a metal plate.

Matching is provided using lumped elements as shown at left. Recommended tuning solutions for 2 frequency ranges are detailed in the parts list below.

### Bias Sequencing

#### Turning the device ON

1. Set  $V_G$  to the pinch-off ( $V_P$ ), typically -5 V.
2. Turn on  $V_D$  to nominal voltage (50 V).
3. Increase  $V_{GS}$  until the  $I_{DS}$  current is reached.
4. Apply RF power to desired level.

#### Turning the device OFF

1. Turn the RF power off.
2. Decrease  $V_G$  down to  $V_P$ .
3. Decrease  $V_D$  down to 0 V.
4. Turn off  $V_G$ .

### Parts List

(N/A = not applicable for this tuning solution)

| Part | Frequency = 1.2 - 1.4 GHz              | Frequency = 1.6 GHz                    |
|------|--|--|
| C1   | 0505, 56 pF, $\pm 5\%$ , 250 V, ATC    | 0505, 36 pF, $\pm 5\%$ , 250 V, ATC    |
| C2   | 0603, 4.7 pF, $\pm 0.1$ pF, 250 V, ATC | N/A                                    |
| C3   | 0603, 10 pF, $\pm 5\%$ , 250 V, ATC    | N/A                                    |
| C4   | 0505, 15 pF, $\pm 5\%$ , 250 V, ATC    | N/A                                    |
| C5   | N/A                                    | 0505, 8.2 pF, $\pm 0.1$ pF, 250 V, ATC |
| C6   | N/A                                    | 0505, 100 pF, $\pm 10\%$ , 200 V, ATC  |
| C7   | 0805, 1000 pF, 100 V, 5%, AVX          | 0805, 1000 pF, 100 V, 5%, AVX          |
| C8   | 0505, 56 pF, $\pm 5\%$ , 250 V, ATC    | 0505, 36 pF, $\pm 5\%$ , 250 V, ATC    |
| C9   | 0505, 2.2 pF, $\pm 0.1$ pF, 250 V, ATC | 0505, 3.0 pF, $\pm 0.1$ pF, 250 V, ATC |
| C10  | 0505, 1.0 pF, $\pm 0.1$ pF, 250 V, ATC | N/A                                    |
| C11  | 0505, 91 pF, $\pm 5\%$ , 250 V, ATC    | 0505, 36 pF, $\pm 5\%$ , 250 V, ATC    |
| C12  | 0805, 1000 pF, 100 V, 5%, AVX          | 0805, 1000 pF, 100 V, 5%, AVX          |
| C13  | 1210, 1 $\mu$ F, 100 V, 20%, ATC       | 1210, 1 $\mu$ F, 100 V, 20%, ATC       |
| R1   | 12 $\Omega$ , 0805, 5%                 | 12 $\Omega$ , 0805, 5%                 |
| R2   | 1.0 $\Omega$ , 0603, 5%                | 1.0 $\Omega$ , 0603, 5%                |
| R3   | 0.33 $\Omega$ , 0603, 5%               | 1.0 $\Omega$ , 0603, 5%                |
| L1   | 0603 CS, 1.6 nH (1.8 nH)               | N/A                                    |
| L2   | 0402 HP, 2.7 nH                        | N/A                                    |
| L3   | 0402 HP, 2.7 nH                        | N/A                                    |
| L4   | 0402 PA, 1.9 nH (0402 HP, 2.0 nH)      | N/A                                    |
| L5   | 0402 PA, 1.9 nH (0402 HP, 2.0 nH)      | N/A                                    |

4

## Evaluation Board Details and Recommended Tuning Solutions (Freq. = 2.7 - 3.5 GHz)

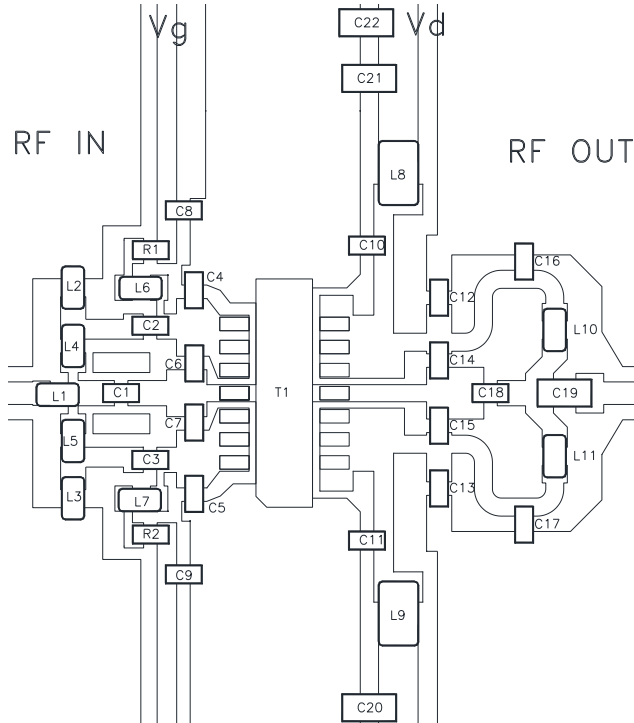

Parts measured on evaluation board (12-mil thick RO4003C). Electrical and thermal ground is provided using a copper-filled via hole array (not pictured), and evaluation board is mounted to a metal plate.

Matching is provided using lumped elements. Recommended tuning solutions for 1 frequency range is detailed in the parts list below.

### Parts List

| Part                 | Value              | Case Style |
|----------------------|--------------------|------------|
| C1                   | 0.7 pF             | 0402       |
| C2, C3               | 1.1 pF             | 0402       |
| C4, C5, C6, C7       | 2.0 pF             | 0402       |
| C8, C9               | 100 pF             | 0402       |
| C10, C11             | 6.8 pF             | 0402       |
| C12, C13, C14, C15   | 1.3 pF             | 0402       |
| C16, C17             | 0.3 pF             | 0402       |
| C18                  | 0.5 pF             | 0402       |
| C19                  | 12 pF              | 0603       |
| C20, C21             | 100 pF             | 0603       |
| C22                  | 10 nF              | 0603       |
| L1, L2, L3, L10, L11 | 1 nH               | 0402       |
| L6, L7               | 12 nH              | 0402       |
| L8, L9               | 12 nH              | 0603       |
| L4, L5               | 2.2 nH             | 0402       |
| R1, R2               | 200 Ω              | 0402       |
| T1                   | MAGX-000035-09000P | 3x6 mm DFN |

### Bias Sequencing

#### Turning the device ON

1. Set  $V_G$  to the pinch-off ( $V_P$ ), typically -5 V.
2. Turn on  $V_D$  to nominal voltage (50 V).
3. Increase  $V_{GS}$  until the  $I_{DS}$  current is reached.
4. Apply RF power to desired level.

#### Turning the device OFF

1. Turn the RF power off.
2. Decrease  $V_G$  down to  $V_P$ .
3. Decrease  $V_D$  down to 0 V.
4. Turn off  $V_G$ .

**Lead-Free 3x6 mm 14-Lead DFN<sup>†</sup>**

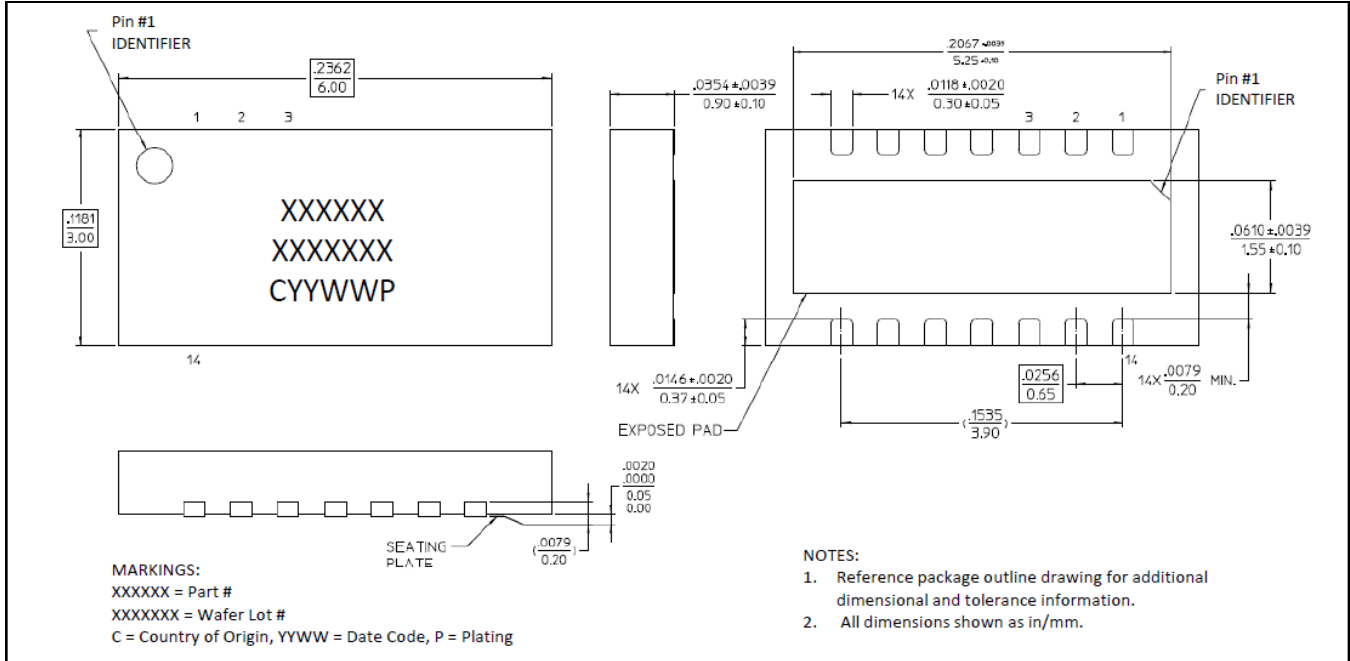

<sup>†</sup> Reference Application Note S2083 for lead-free solder reflow recommendations.  
 Meets JEDEC moisture sensitivity level 1 requirements.  
 Plating is Ni/Pd/Au.

## Handling Procedures

Please observe the following precautions to avoid damage:

## Static Sensitivity

Gallium Nitride Devices and Circuits are sensitive to electrostatic discharge (ESD) and can be damaged by static electricity. Proper ESD control techniques should be used when handling these Class 1B devices.

## Applications Section

S-Parameter Data:  $T_A = 25^\circ\text{C}$ ,  $V_{DD} = +50\text{ V}$ ,  $I_{DQ} = 200\text{ mA}$

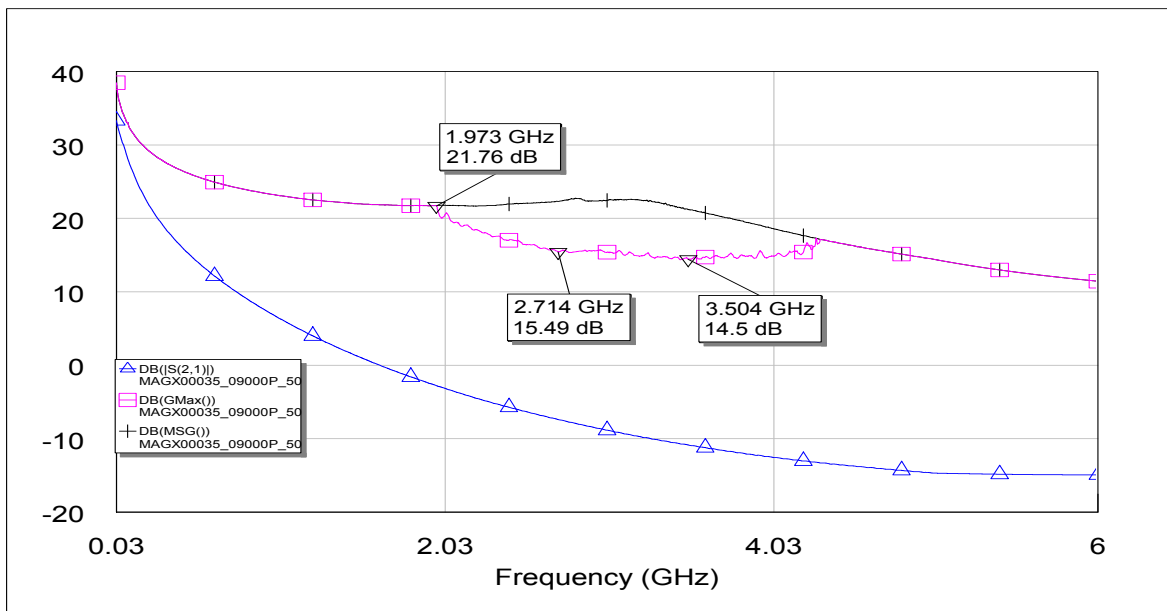
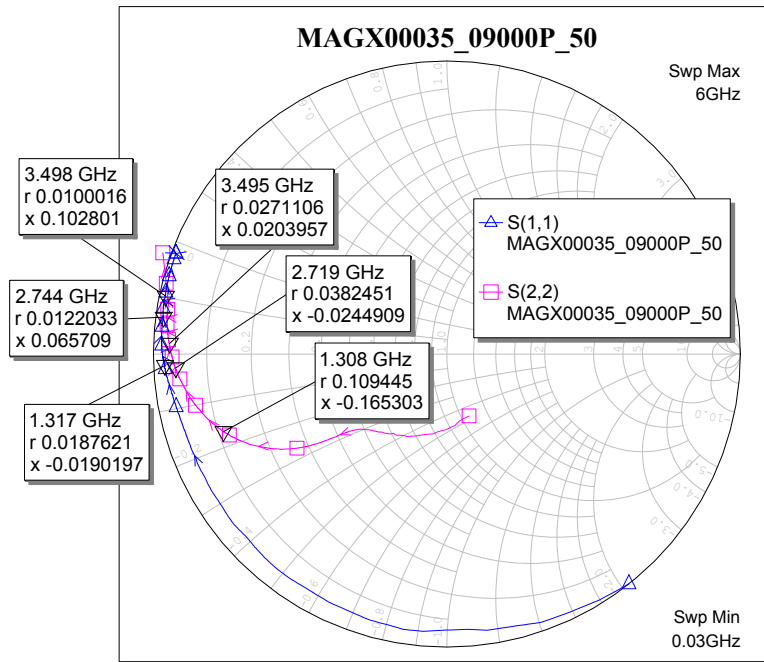

## Applications Section

**Thermal Performance: Freq. = 1.6 GHz,  $T_C = 85^\circ\text{C}$ ,  $V_{DD} = +50\text{ V}$ ,  $I_{DQ} = 100\text{ mA}$ ,  $Z_0 = 50\ \Omega$**

**Power (Output & Dissipated) vs. Transient Junction Temperature, Pulse Duration and Duty Cycle**

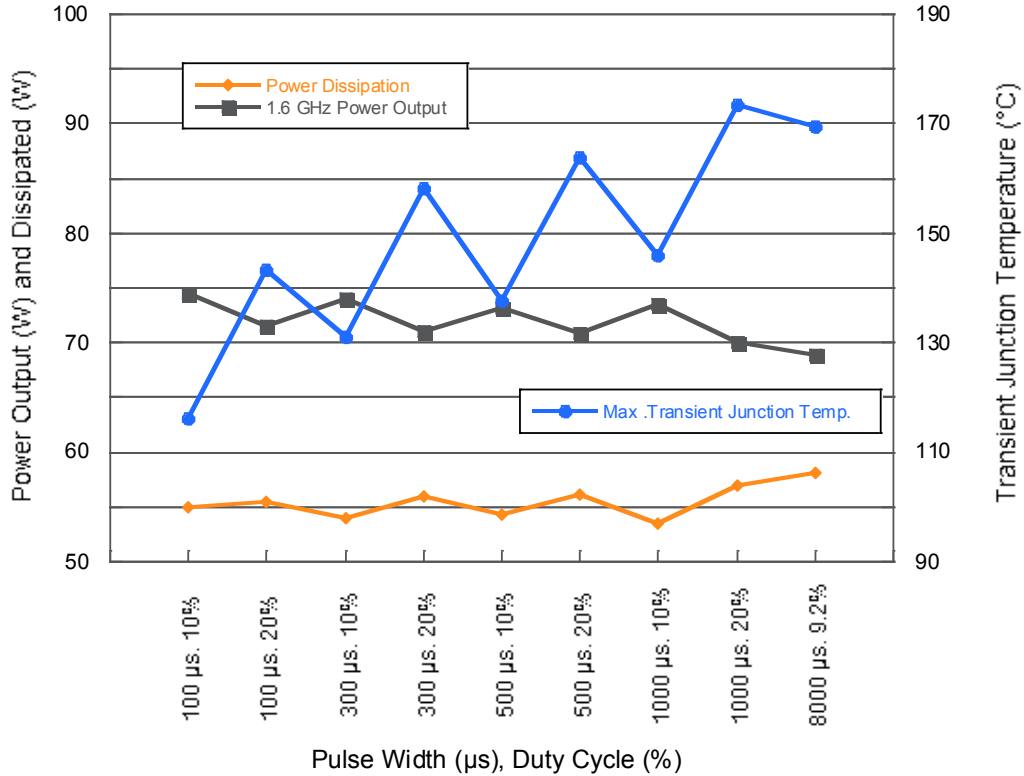

| Pulse Width, Duty Cycle            | 100 μs, 10% | 100 μs, 20% | 300 μs, 10% | 300 μs, 20% | 500 μs, 10% | 500 μs, 20% | 1000 μs, 10% | 1000 μs, 20% | 8000 μs, 9.2% |
|------------------------------------|-------------|-------------|-------------|-------------|-------------|-------------|--------------|--------------|---------------|
| Power Dissipation (W)              | 55          | 55.4        | 54          | 55.9        | 54.3        | 56.2        | 53.5         | 57           | 58.2          |
| 1.6 GHz P <sub>OUT</sub> (W)       | 74.5        | 71.6        | 74          | 71.1        | 73.2        | 70.8        | 73.5         | 70           | 68.8          |
| Max. Transient Junction Temp. (°C) | 116.3       | 143.4       | 131.0       | 158.2       | 137.6       | 164.0       | 146.0        | 173.4        | 169.4         |

Junction temperature measured using High-Speed Transient (HST) temperature detection microscopy.



## Applications Section

Typical Performance Curves (reference 1.2 - 1.4 GHz parts list):

1.2 - 1.4 GHz, 3 ms Pulse, 10% Duty Cycle,  $V_{DD} = +50\text{ V}$ ,  $T_A = 25^\circ\text{C}$ ,  $Z_0 = 50\ \Omega$

**Gain vs. Input Power**

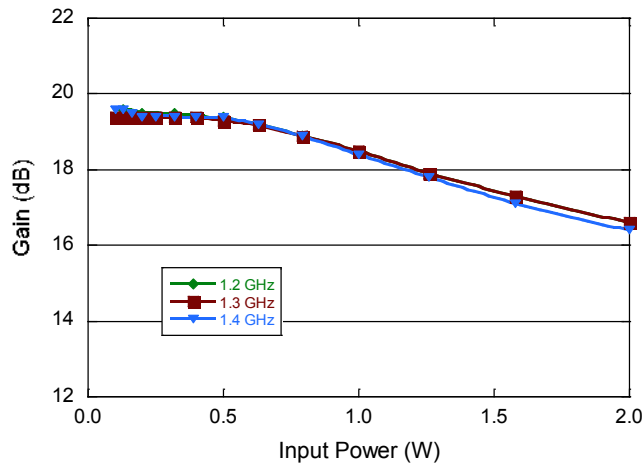

**Output Power vs. Input Power**

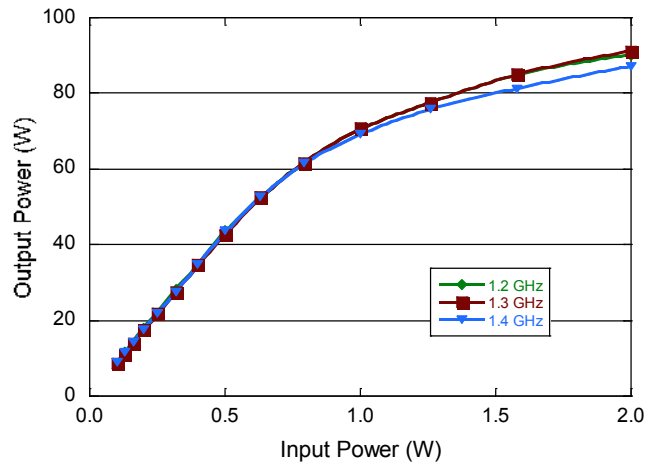

**PAE vs. Input Power**

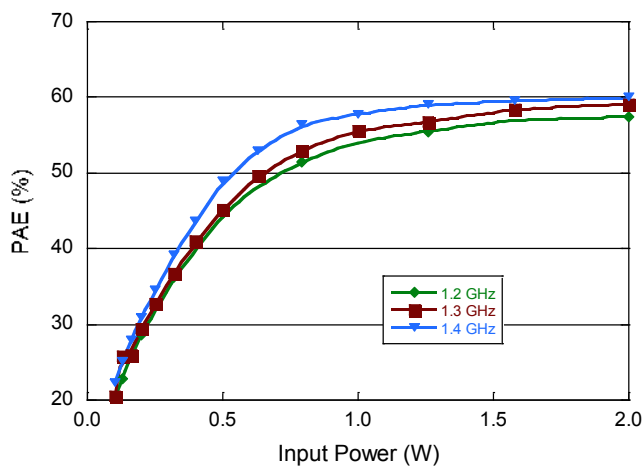

## Applications Section

Typical Performance Curves (reference 1.6 GHz parts list):

1.6 GHz, 1 ms Pulse, 10% Duty Cycle,  $V_{DD} = +50\text{ V}$ ,  $T_A = 25^\circ\text{C}$ ,  $Z_0 = 50\ \Omega$

**Gain vs. Input Power**

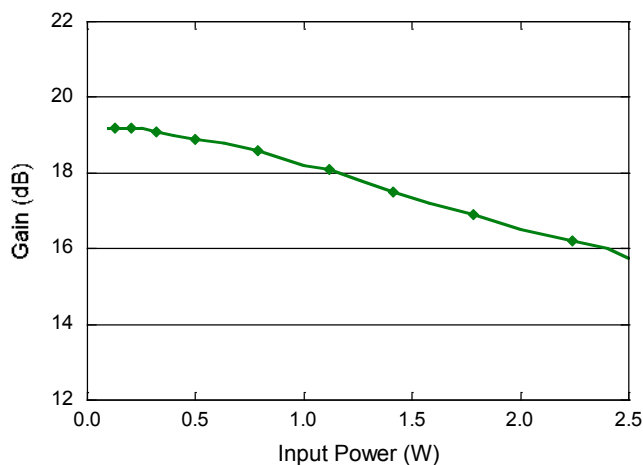

**Output Power vs. Input Power**

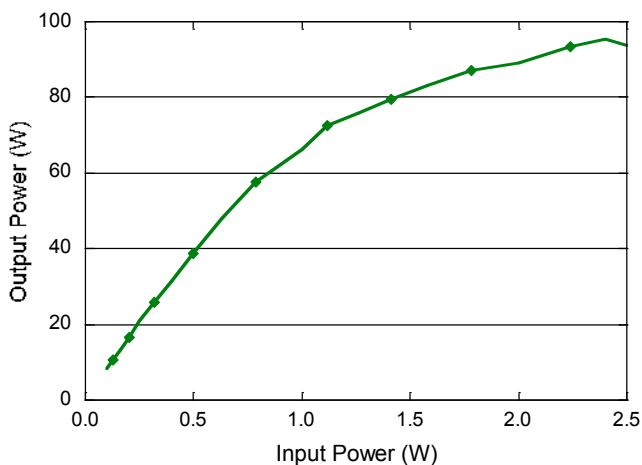

**PAE vs. Input Power**

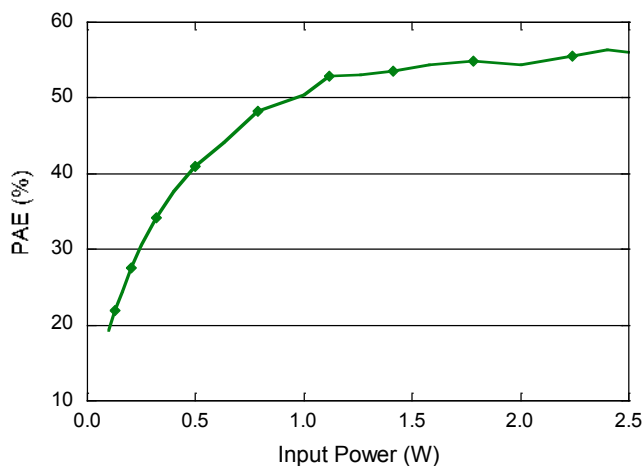

## Applications Section

Typical Performance Curves (reference 2.7 - 3.1 GHz parts list):

2.7 - 3.1 GHz, 1 ms Pulse, 10% Duty Cycle,  $V_{DD} = +50\text{ V}$ ,  $T_A = 25^\circ\text{C}$ ,  $Z_0 = 50\ \Omega$

**Gain vs. Frequency**

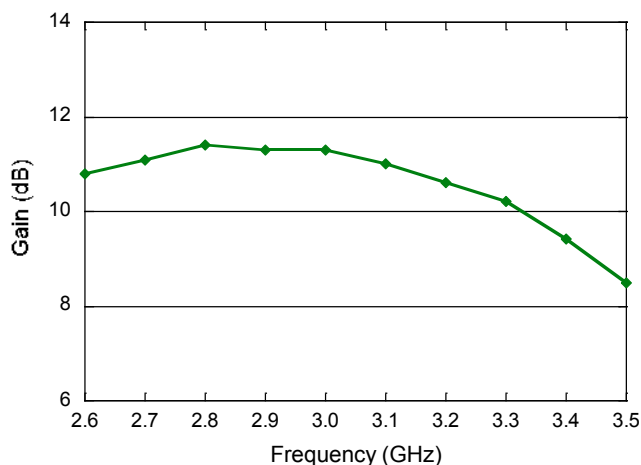

**Output Power vs. Frequency**

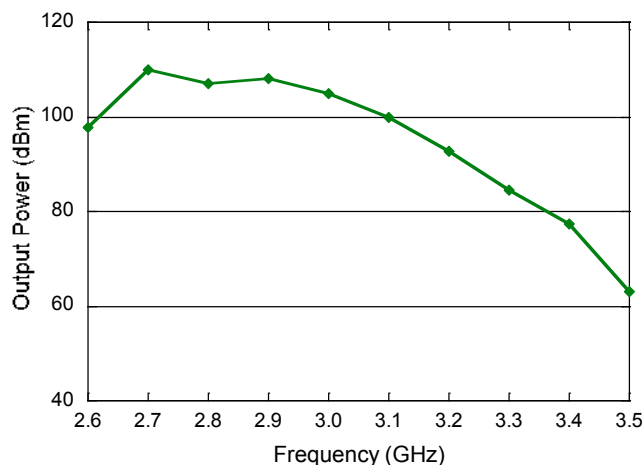

**PAE vs. Frequency**

