

Model 93 - 3100 series

Definite Purpose Contactor 3-pole, 50-60 FLA AC Coil

UL File E75492
CE File EN60947-4-1:1991
IEC 947-4-1

Users should thoroughly review the technical data before selecting a product part number. It is recommended that users also seek out the pertinent approvals files of the agencies/laboratories and review them to ensure the product meets the requirements for a given application.

Features

- 3-pole contactors.
- Convenient "universal" mounting plate.
- Optional interlock/auxiliary switches available.

Contact Data @ 25°C

Arrangements: 3 Form X (3PST-NO-DM).
Maximum Ratings: See Contact Ratings Table.
Material: Silver Cadmium Oxide.

Coil Data @ 25°C

Voltage: 24 - 480 VAC, 50/60 Hz. See Coil Data Table below.
Insulation Class: UL Class B (130°C).
Duty Cycle: Continuous.

Environmental Data

Temperature Range: Storage and Operating: -40°C – +65°C.
Flammability: UL 94-HB housing.

Mechanical Data

Contact Termination:

Type: Box Lug with dual 0.250" (6.35 mm) quick connects.

Wire Size: 14-2 Cu/Al AWG

Tightening Torque: 50 in.-lbs.

Coil Termination: Dual 0.250" (6.35 mm) quick connects, standard.
A 0.250" quick connect and a #6-32 screw, optional.

Arc Cover: Standard.

Weight: 32 oz. (910 g) approximately

Contact Ratings

Full Load Amps	Number of Poles	Line Voltage	Locked Rotor Amps	Resistive Amps	Tungsten/Ballast Amps	Maximum Horsepower		
						Voltage	Single Phase	Three Phase
50	3	240	300	65	-	110/120	3	-
		480	250	65	53	200/208	7.5	15
		600	200	65	-	240/277	10	15
						480	-	25
		600				600	-	25
60	3	240	360	75	-	110/120	5	-
		480	300	75	53	200/208	7.5	25
		600	240	75	-	240/277	10	25
						480	-	30
		600				600	-	30

Coil Data

Nominal Coil Voltage	24	120	208/240	277	480
Maximum Pickup Volts	182	93	177	235	374
Drop-Out Volts Range	6 -15	20 - 70	40 - 135	50-180	120 - 286
Nominal Inrush VA @ 50 Hz	140	140	140	140	140
Nominal Inrush VA @ 60 Hz	132	132	132	132	132
Nominal Sealed VA @ 50 Hz	20	20	20	20	20
Nominal Sealed VA @ 60 Hz	14	14	14	14	14
Nominal DC Resistance - Ohms	2.4	45	180	280	852

Ordering Information

Typical Part No. ▶	3100	-	30	I	16	999	
<p>1. Series: 3100 = 3-pole, 50-60 FLA contactor</p> <p>2. Packaging: Y = Individual Pack - = Bulk Pack A-ZZZ = Customer specific information (assigned by factory)</p> <p>3. Pole Configuration: 30 = 3 Form X (3PST-NO-DM)</p> <p>4. Coil Voltage (50/60 Hz.): I = 24VAC, molded K = 208/240VAC, molded J = 120VAC, molded M = 277VAC, molded W = 480VAC, molded</p> <p>5. Contact Ratings (Inductive): 16 = 50 FLA 17 = 60 FLA</p> <p>6. Customer ID Suffix: 999 = Standard Model 000-998 = Factory assigned customer ID</p> <p>7. Option Code: Leave Blank = No customer-specific options A - ZZ = Factory assigned customer-specific options.</p>							

Standard part numbers listed below are more likely to be available from stock.

None at present.

Outline Dimensions

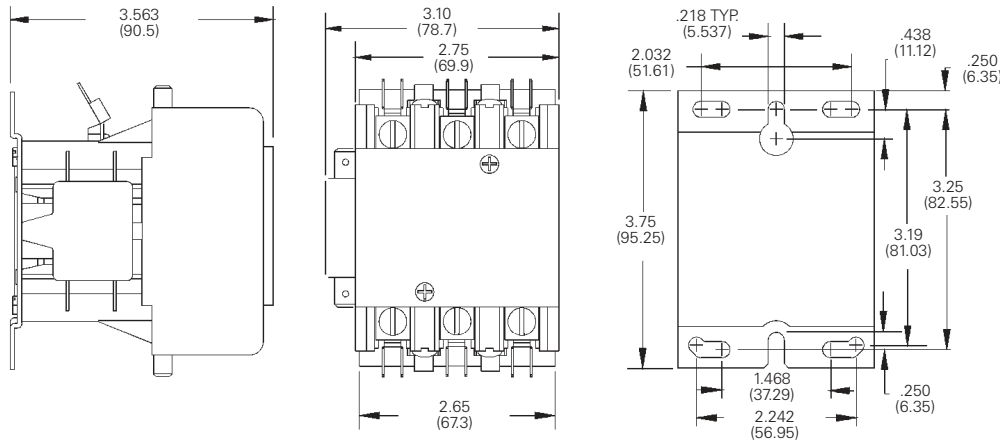

Shown with Optional Auxiliary Switch

Termination

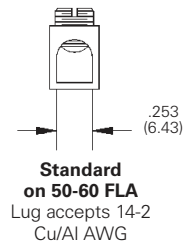

Various interlock / auxiliary switches are available for the Model 93 contactor.

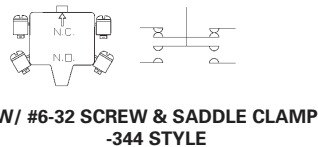
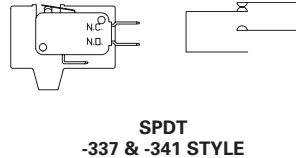
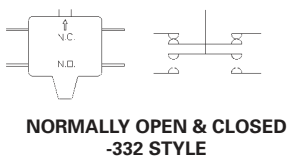
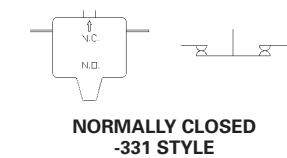
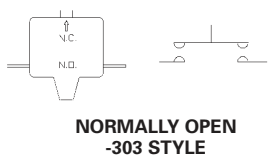

Dimensions are shown for reference purposes only.

Dimensions are in inches over (millimeters) unless otherwise specified.

Equipped with 0.250" (6.35) Quick Connect Terminals

Description	Factory Modifications		Field Added Kits	
	Contact Config. NO	NC	Kit Catalog Number	Number of Kits Required
Single unit interlock configurations listed.	1	0	34300-303	1
	0	1	34300-331	1
Maximum of two. Must be same polarity.	1	1	34300-332	1
	2	0	34300-303	2
See footnote (1) for ratings.	0	2	34300-331	2
	2	2	34300-332	2
SPDT Circuit	1	1	34300-337	1
See footnote (2) for ratings.	2	2	34300-337	2
SPDT Dry Circuit, 0.1 amp max.	1	1	34300-341	1
Gold Flashed Contacts	2	2	34300-340	1

Equipped with #6-32 Screw Terminals & Saddle Clamps

Description	Factory Modifications		Field Added Kits	
	Contact Config. NO	NC	Kit Catalog Number	Number of Kits Required
Single unit interlock configurations listed.	1	0	34300-342	1
	0	1	34300-343	1
Maximum of two. Must be same polarity. (note 1)	1	1	34300-344	1

Footnotes: Ratings of Auxiliary Interlocks / Switches

(1) Contact Rating Single Circuit NO or NC and two circuit NO/NC:	120V	240V	480V	600V	(2) Contact Rating SPDT (337):
Break	3.0A	1.5A	0.75A	0.6A	10A, 1/3 HP, 125 or 250 VAC
Make	30A	15A	7.5A	6A	1/2A, 125 VDC; 1/4A, 250 VDC;
Continuous	10A	10A	10A	10A	4A 120 VAC on Lamp Load

Specifications and availability subject to change.

www.tycoelectronics.com
Technical support:
Refer to inside back cover.