

National Semiconductor is now part of  
Texas Instruments.

Search <http://www.ti.com/> for the latest technical  
information and details on our current products and services.

# LM4845 Boomer<sup>®</sup> Audio Power Amplifier Series

## Output Capacitor-less Audio Subsystem with Programmable National 3D

### General Description

The LM4845 is an audio power amplifier capable of delivering 500mW of continuous average power into a mono 8 $\Omega$  bridged-tied load (BTL) with 1% THD+N, 25mW per channel of continuous average power into stereo 32 $\Omega$  single-ended (SE) loads with 1% THD+N, or an output capacitor-less (OCL) configuration with identical specification as the SE configuration, from a 3.3V power supply.

The LM4845 features a 32-step digital volume control and eight distinct output modes. The digital volume control, 3D enhancement, and output modes (mono/SE/OCL) are programmed through a two-wire I<sup>2</sup>C or a three-wire SPI compatible interface that allows flexibility in routing and mixing audio channels. The LM4845 has three input channels: one pair for a two-channel stereo signal and the third for a single-channel mono input.

The LM4845 is designed for cellular phone, PDA, and other portable handheld applications. It delivers high quality output power from a surface-mount package and requires only seven external components in the OCL mode (two additional components in SE mode).

### Key Specifications

■ THD+N at 1kHz, 500mW into 8 $\Omega$ BTL (3.3V)	1.0% (typ)
■ THD+N at 1kHz, 30mW into 32 $\Omega$ SE (3.3V)	1.0% (typ)
■ Single Supply Operation ( $V_{DD}$ )	2.7 to 5.5V
■ I <sup>2</sup> C/SPI Single Supply Operation	2.2 to 5.5V

### Features

- I<sup>2</sup>C/SPI Control Interface
- I<sup>2</sup>C/SPI programmable National 3D Audio
- I<sup>2</sup>C/SPI controlled 32 step digital volume control (-54dB to +18dB)
- Three independent volume channels (Left, Right, Mono)
- Eight distinct output modes
- microSMD surface mount packaging
- "Click and Pop" suppression circuitry
- Thermal shutdown protection
- Low shutdown current (0.1 $\mu$ A, typ)

### Applications

- Mobile Phones
- PDAs

# Typical Application

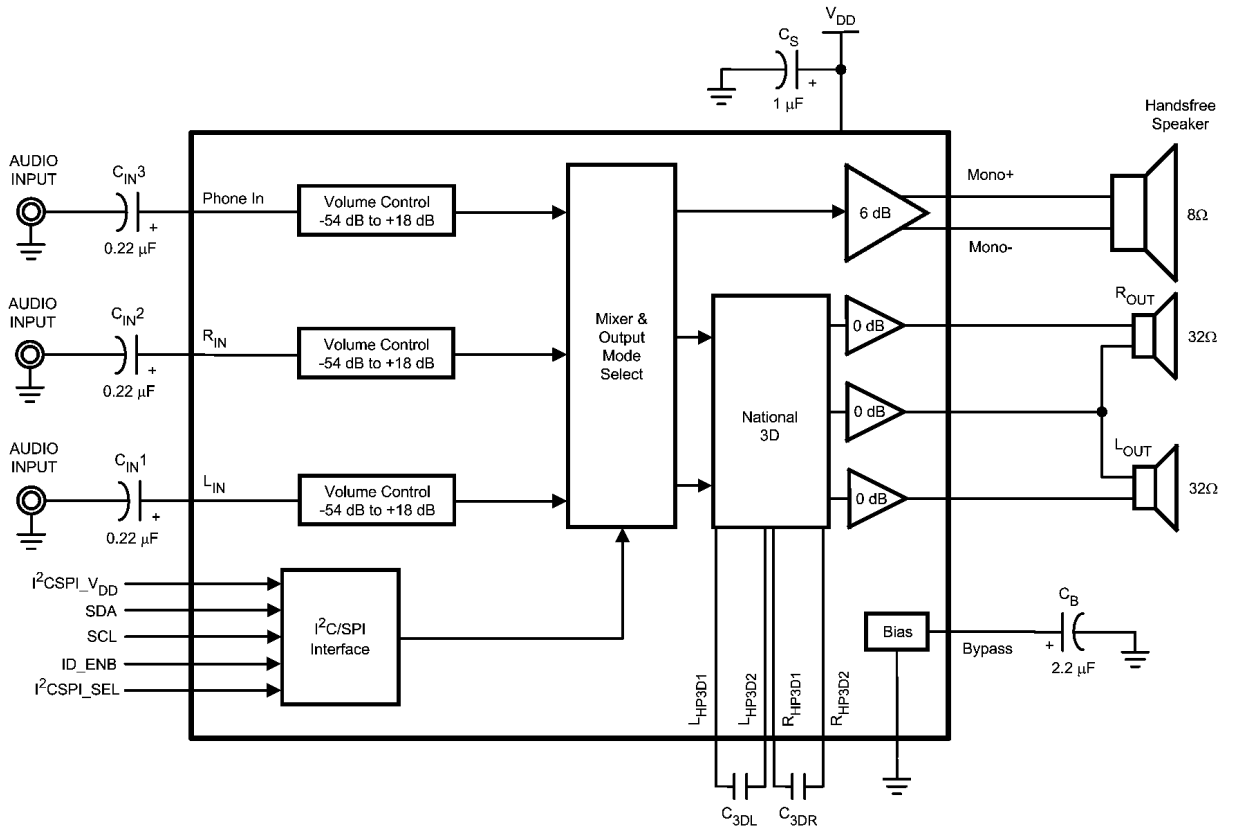

20105966

FIGURE 1. Typical Audio Amplifier Application Circuit-Output Capacitor-less

Typical Application (Continued)

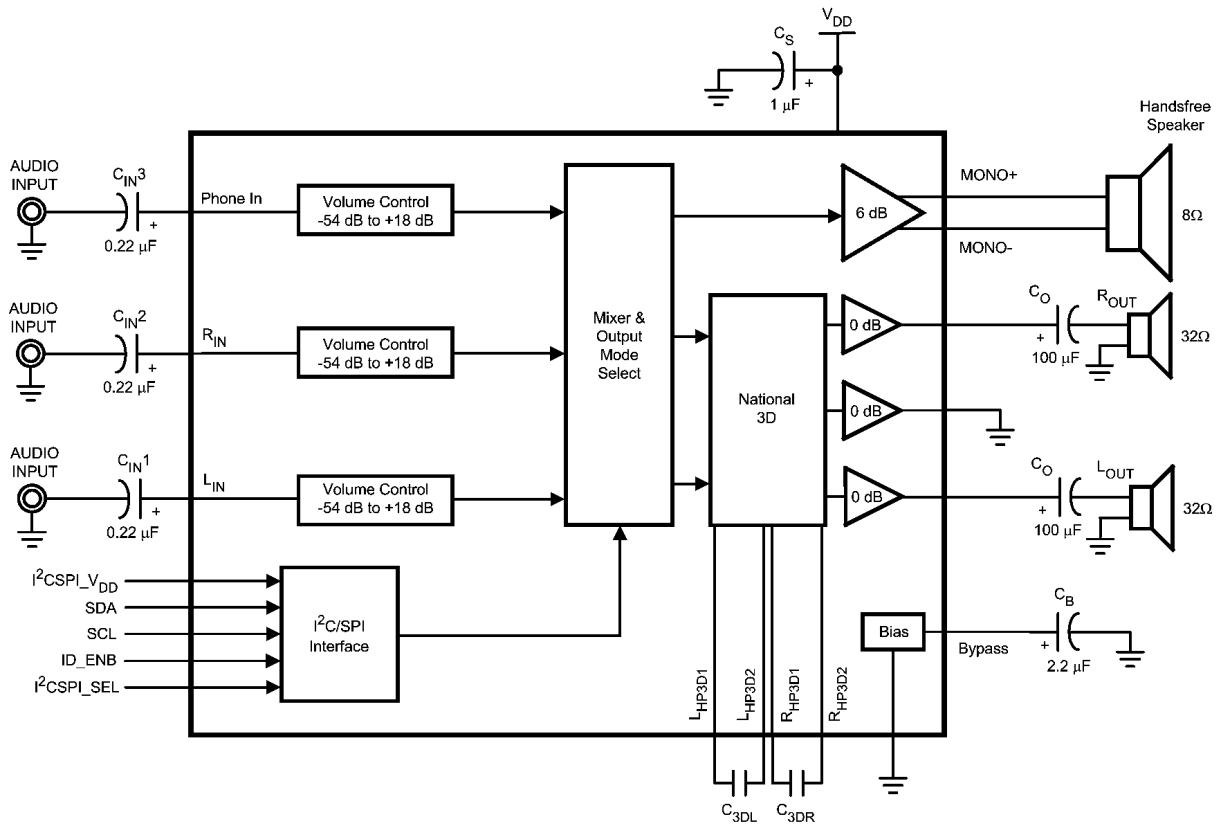

20105967

FIGURE 2. Typical Audio Amplifier Application Circuit-Single Ended

## Connection Diagrams

### 25-Bump micro SMD

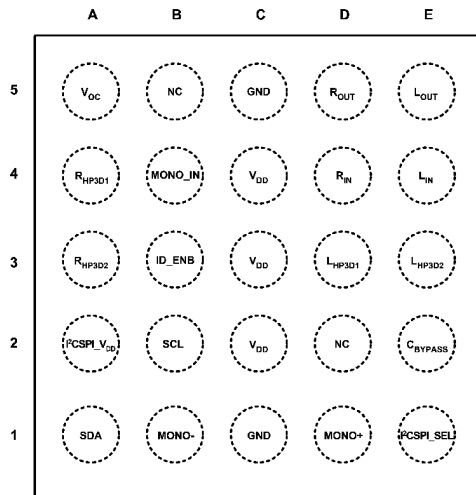

Top View

201059K1

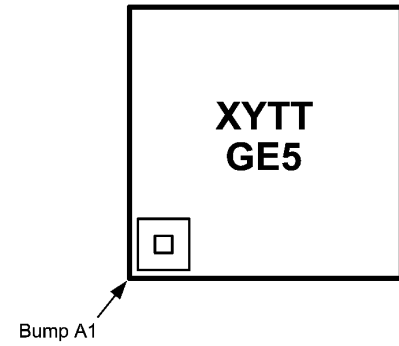

201059K0

Top View  
 XY - Date Code  
 TT - Die Traceability  
 G - Boomer Family  
 E5 - LM4845ITL

	Bump	Name	Description
1	A1	SDA	I <sup>2</sup> C or SPI Data
2	A2	I <sup>2</sup> CSPIV <sub>DD</sub>	I <sup>2</sup> C or SPI Interface Power Supply
3	A3	R <sub>HP3D2</sub>	Right Headphone 3D Input 2
4	A4	R <sub>HP3D1</sub>	Right Headphone 3D Input 1
5	A5	V <sub>OC</sub>	Center Amplifier Output
6	B1	MONO <sub>-</sub>	Loudspeaker Negative Output
7	B2	SCL	I <sup>2</sup> C or SPI Clock
8	B3	ID_ENB	Address Identification/Enable Bar
9	B4	Phone_In	Mono Input
10	B5	NC	No Connect
11	C1	GND	Ground
12	C2	V <sub>DD</sub>	Power Supply
13	C3	V <sub>DD</sub>	Power Supply
14	C4	V <sub>DD</sub>	Power Supply
15	C5	GND	GND
16	D1	MONO <sub>+</sub>	Loudspeaker Positive Output
17	D2	NC	No Connect
18	D3	L <sub>HP3D1</sub>	Left Headphone 3D Input 1
19	D4	R <sub>IN</sub>	Right Input Channel
20	D5	R <sub>OUT</sub>	Right Headphone Output
21	E1	I <sup>2</sup> C SPI_SEL	I <sup>2</sup> C or SPI Select
22	E2	C <sub>BYPASS</sub>	Half-Supply Bypass
23	E3	L <sub>HP3D2</sub>	Left Headphone 3D Input 2
24	E4	L <sub>IN</sub>	Left Input Channel
25	E5	L <sub>OUT</sub>	Left Headphone Output

**Absolute Maximum Ratings** (Note 2)

If Military/Aerospace specified devices are required, please contact the National Semiconductor Sales Office/Distributors for availability and specifications.

Supply Voltage	6.0V
Storage Temperature	-65°C to +150°C
Input Voltage	-0.3 to $V_{DD} + 0.3$
ESD Susceptibility (Note 3)	2.0kV
ESD Machine model (Note 6)	200V
Junction Temperature ( $T_J$ )	150°C
Solder Information (Note 1)	

Vapor Phase (60 sec.)	215°C
Infrared (15 sec.)	220°C
Thermal Resistance	
$\theta_{JA}$ (typ) - TLA25CBA	65°C/W (Note 8)

**Operating Ratings** (Note 2)

Temperature Range	-40°C to 85°C
Supply Voltage ( $V_{DD}$ )	$2.7V \leq V_{DD} \leq 5.5V$
Supply Voltage ( $I^2C/SPI$ )	$2.2V \leq V_{DD} \leq 5.5V$

**Electrical Characteristics 3.3V** (Notes 2, 7)

The following specifications apply for  $V_{DD} = 3.3V$ ,  $T_A = 25^\circ C$  unless otherwise specified. [ $A_V = 2$  (BTL),  $A_V = 1$  (SE)]

Symbol	Parameter	Conditions	LM4845		Units (Limits)	
			Typical (Note 4)	Limits (Note 5)		
$I_{DD}$	Supply Current	Output Modes 2, 4, 6 $V_{IN} = 0V$ ; No load, OCL = 0 (Table 2)	3.3	6.5	mA (max)	
		Output Modes 1, 3, 5, 7 $V_{IN} = 0V$ ; No load, BTL, OCL = 0 (Table 2)	6	11	mA (max)	
$I_{SD}$	Shutdown Current	Output Mode 0	0.1	1	$\mu A$ (max)	
$V_{OS}$	Output Offset Voltage	$V_{IN} = 0V$ , Mode 5 (Note 10)	10	50	mV (max)	
$P_O$	Output Power	MONO <sub>OUT</sub> ; $R_L = 8\Omega$ THD+N = 1%; $f = 1kHz$ , BTL, Mode 1	500	400	mW (min)	
		$R_{OUT}$ and $L_{OUT}$ ; $R_L = 32\Omega$ THD+N = 1%; $f = 1kHz$ , SE, Mode 4	42	20	mW (min)	
THD+N	Total Harmonic Distortion Plus Noise	MONO <sub>OUT</sub> $f = 20Hz$ to $20kHz$ $P_{OUT} = 250mW$ ; $R_L = 8\Omega$ , BTL, Mode 1	0.5		%	
		$R_{OUT}$ and $L_{OUT}$ $f = 20Hz$ to $20kHz$ $P_{OUT} = 12mW$ ; $R_L = 32\Omega$ , SE, Mode 4	0.5		%	
$N_{OUT}$	Output Noise	A-weighted (Note 9), Mode 5, BTL input referred	26		$\mu V$	
PSRR	Power Supply Rejection Ratio MONO <sub>OUT</sub>	$V_{RIPPLE} = 200mV_{PP}$ ; $f = 217Hz$ , $C_B = 2.2\mu F$ , BTL All audio inputs terminated into $50\Omega$ ; output referred gain = 6dB (BTL)				
		Output Mode 1,7	71		dB	
		Output Mode 3	68		dB	
		Output Mode 5	63		dB	
	Power Supply Rejection Ratio $R_{OUT}$ and $L_{OUT}$	$V_{RIPPLE} = 200mV_{PP}$ ; $f = 217Hz$ $C_B = 2.2\mu F$ , SE, $C_O = 100\mu F$ All audio inputs terminated into $50\Omega$ ; output referred gain, OCL = 0 (Table 2)				
		Output Mode 2	88		dB	
		Output Mode 4	76		dB	
	Output Mode 6, 7	76		dB		

**Electrical Characteristics 3.3V** (Notes 2, 7) (Continued)The following specifications apply for  $V_{DD} = 3.3V$ ,  $T_A = 25^\circ C$  unless otherwise specified. [ $A_V = 2$  (BTL),  $A_V = 1$  (SE)]

Symbol	Parameter	Conditions	LM4845		Units (Limits)
			Typical (Note 4)	Limits (Note 5)	
	Digital Volume Range ( $R_{IN}$ and $L_{IN}$ )	Input referred maximum attenuation	-54	-53.25 -54.75	dB (min) dB (max)
		Input referred maximum gain	18	17.25 18.75	dB (min) dB (max)
	Mute Attenuation	Output Mode 1, 3, 5	80		dB
	MONO_IN Input Impedance $R_{IN}$ and $L_{IN}$ Input Impedance	Maximum gain setting	11	8 14	k $\Omega$ (min) k $\Omega$ (max)
Maximum attenuation setting		100	75 125	k $\Omega$ (min) k $\Omega$ (max)	
$T_{WU}$	Wake-Up Time from Shutdown	$C_B = 2.2\mu F$ , OCL	90		ms
		$C_B = 2.2\mu F$ , SE	138		

## Electrical Characteristics 5.0V (Notes 3, 7)

The following specifications apply for  $V_{DD} = 5.0V$ ,  $T_A = 25^\circ C$  unless otherwise specified. [ $A_V = 2$  (BTL),  $A_V = 1$  (SE)].

Symbol	Parameter	Conditions	LM4845		Units (Limits)	
			Typical (Note 4)	Limits (Notes 5, 10)		
$I_{DD}$	Supply Current	Output Modes 2, 4, 6 $V_{IN} = 0V$ ; No load, OCL = 0 (Table 2)	3.6		mA	
		Output Modes 1, 3, 5, 7 $V_{IN} = 0V$ ; No Load, OCL = 0 (Table 2)	6.8		mA	
$I_{SD}$	Shutdown Current	Output Mode 0	0.1		$\mu A$	
$V_{OS}$	Output Offset Voltage	$V_{IN} = 0V$ , Mode 5 (Note 10)	10		mV	
$P_O$	Output Power	MONO <sub>OUT</sub> ; $R_L = 8\Omega$ THD+N = 1%; $f = 1kHz$ , BTL, Mode 1	1.15		W	
		$R_{OUT}$ and $L_{OUT}$ ; $R_L = 32\Omega$ THD+N = 1%; $f = 1kHz$ , SE, Mode 4	75		mW	
THD+N	Total Harmonic Distortion Plus Noise	MONO <sub>OUT</sub> $f = 20Hz$ to $20kHz$ $P_{OUT} = 500mW$ ; $R_L = 8\Omega$ , BTL, Mode 1	0.5		%	
		$R_{OUT}$ and $L_{OUT}$ $f = 20Hz$ to $20kHz$ $P_{OUT} = 30mW$ ; $R_L = 32\Omega$ , SE, Mode 4	0.5		%	
$N_{OUT}$	Output Noise	A-weighted (Note 9), Mode 5, BTL input referred	26		$\mu V$	
PSRR	Power Supply Rejection Ratio MONO <sub>OUT</sub>	$V_{RIPPLE} = 200mV_{PP}$ ; $f = 217Hz$ , $C_B = 2.2\mu F$ , BTL All audio inputs terminated into $50\Omega$ ; output referred gain = 6dB (BTL)				
		Output Mode 1, 7	71		dB	
		Output Mode 3	68		dB	
		Output Mode 5	63		dB	
	Power Supply Rejection Ratio $R_{OUT}$ and $L_{OUT}$	$V_{RIPPLE} = 200mV_{PP}$ ; $f = 217Hz$ , $C_B = 2.2\mu F$ , SE, $C_O = 100\mu F$ All audio inputs terminated into $50\Omega$ ; output referred gain, OCL = 0 (Table 2)				
		Output Mode 2	88		dB	
		Output Mode 4	76		dB	
Output Mode 6, 7	76		dB			
Digital Volume Range ( $R_{IN}$ and $L_{IN}$ )	Input referred maximum attenuation		-54	-53.25 -54.75	dB dB	
		Input referred maximum gain	18	17.25 18.75	dB dB	
	Mute Attenuation	Output Mode 1, 3, 5	80		dB	
	MONO_IN Input Impedance $R_{IN}$ and $L_{IN}$ Input Impedance	Maximum gain setting		11		k $\Omega$ k $\Omega$
		Minimum gain setting		100		k $\Omega$ k $\Omega$
$T_{WU}$	Wake-Up Time from Shutdown	$C_B = 2.2\mu F$ , OCL	122		ms	
		$C_B = 2.2\mu F$ , SE	184			



**I<sup>2</sup>C/SPI** (Notes 2, 7)

The following specifications apply for  $V_{DD} = 5.0V$  and  $3.3V$ ,  $T_A = 25^\circ C$  unless otherwise specified.

Symbol	Parameter	Conditions	LM4845		Units (Limits)
			Typical (Note 4)	Limits (Notes 5, 10)	
$t_1$	I <sup>2</sup> C Clock Period			2.5	$\mu s$ (max)
$t_2$	I <sup>2</sup> C Clock Setup Time			100	ns (min)
$t_3$	I <sup>2</sup> C Data Hold Time			100	ns (min)
$t_4$	Start Condition Time			100	ns (min)
$t_5$	Stop Condition Time			100	ns (min)
$f_{SPI}$	Maximum SPI Frequency			1000	kHz (max)
$t_{EL}$	SPI ENB Low Time			100	ns (min)
$t_{DS}$	SPI Data Setup Time			100	$\mu s$ (max)
$t_{ES}$	SPI ENB Setup Time			100	ns (min)
$t_{DH}$	SPI Data Hold Time			100	ns (min)
$t_{EH}$	SPI Enable Hold Time			100	ns (min)
$t_{CL}$	SPI Clock Low Time			500	ns (min)
$t_{CH}$	SPI Clock High Time			500	ns (min)
$t_{CS}$	SPI Clock Transition Time			100	ns (min)
$V_{IH}$	I <sup>2</sup> C/SPI Input Voltage High			$0.7 \times I^2CSPI$ $V_{DD}$	V (min)
$V_{IL}$	I <sup>2</sup> C/SPI Input Voltage Low			$0.3 \times I^2CSPI$ $V_{DD}$	V (max)

**Note 1:** See AN-450 "Surface Mounting and their effects on Product Reliability" for other methods of soldering surface mount devices.

**Note 2:** Operating Ratings indicate conditions for which the device is functional, but do not guarantee specific performance limits. For guaranteed specifications and test conditions, see the Electrical Characteristics. The guaranteed specifications apply only for the test conditions listed. Some performance characteristics may degrade when the device is not operated under the listed test conditions.

**Note 3:** Human body model, 100pF discharged through a 1.5k $\Omega$  resistor.

**Note 4:** Typical specifications are specified at +25 $^\circ C$  and represent the most likely parametric norm.

**Note 5:** Tested limits are guaranteed to National's AOQL (Average Outgoing Quality Level).

**Note 6:** Machine Model ESD test is covered by specification EIAJ IC-121-1981. A 200pF cap is charged to the specified voltage, then discharged directly into the IC with no external series resistor (resistance of discharge path must be under 50 $\Omega$ ).

**Note 7:** All voltages are measured with respect to the ground pin, unless otherwise specified.

**Note 8:** The given  $\theta_{JA}$  for an LM4845ITL mounted on a demonstration board with a 9in<sup>2</sup> area of 1oz printed circuit board copper ground plane.

**Note 9:** Datasheet min/max specifications are guaranteed by design, test, or statistical analysis.

**Note 10:** Potentially worse case: All three input stages are DC coupled to the BTL output stage.

## External Components Description

Components		Functional Description
1	$C_{IN}$	This is the input coupling capacitor. It blocks the DC voltage and couples the input signal to the amplifier's input terminals. $C_{IN}$ also creates a highpass filter with the internal resistor $R_i$ (Input Impedance) at $f_c = 1/(2\pi R_i C_{IN})$ .
2	$C_{SUPPLY}$	This is the supply bypass capacitor. It filters the supply voltage applied to the $V_{DD}$ pin.
3	$C_{BYPASS}$	This is the BYPASS pin capacitor. It filters the $1/2V_{DD}$ voltage.
4	$C_{3DL}$	This is the left channel 3D capacitor.
5	$C_{3DR}$	This is the right channel 3D capacitor.
6	$C_{OL}$	This is the left channel DC blocking output capacitor.
7	$C_{OR}$	This is the right channel DC blocking output capacitor.
8	$C_{I2CSPI\_SUPPLY}$	This is the I <sup>2</sup> C/SPI supply bypass capacitor. It filters the I <sup>2</sup> C/SPI supply voltage applied to the I <sup>2</sup> C/SPI_ $V_{DD}$ pin.
9	$R_{3DL}$	This is the left channel 3D external resistor. <b>OPTIONAL.</b>
10	$R_{3DR}$	This is the right channel 3D external resistor. <b>OPTIONAL.</b>

## Typical Performance Characteristics

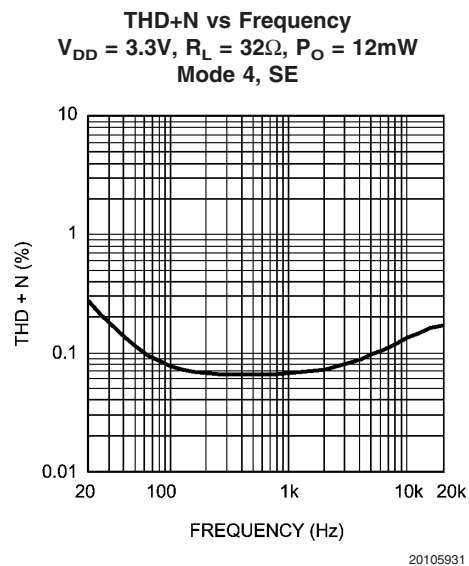
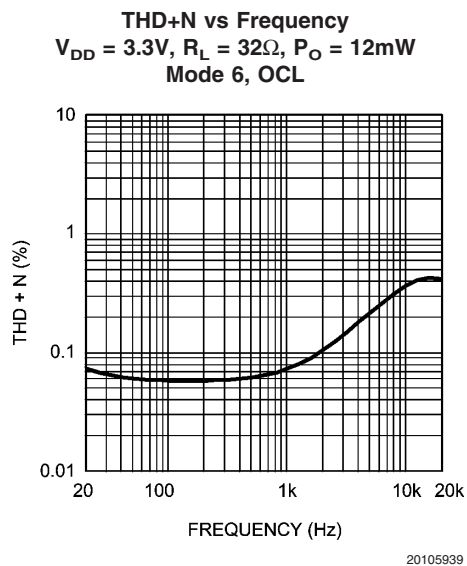
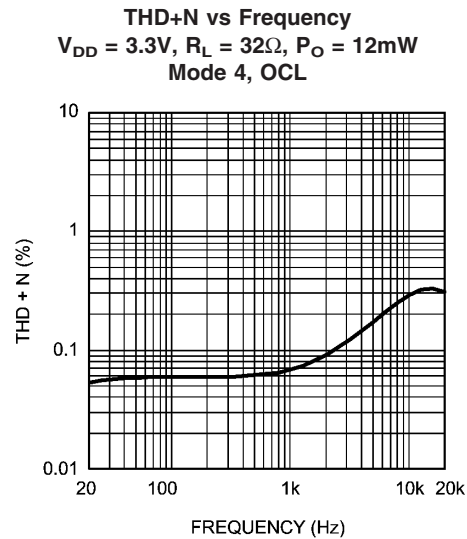
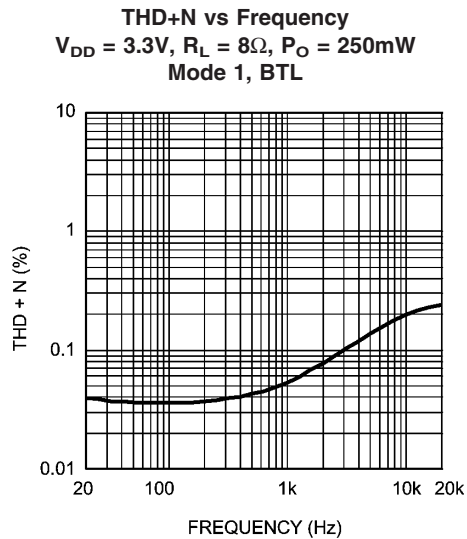

Typical Performance Characteristics (Continued)

**THD+N vs Frequency**  
 $V_{DD} = 3.3V, R_L = 32\Omega, P_O = 12mW$   
 Mode 6, SE

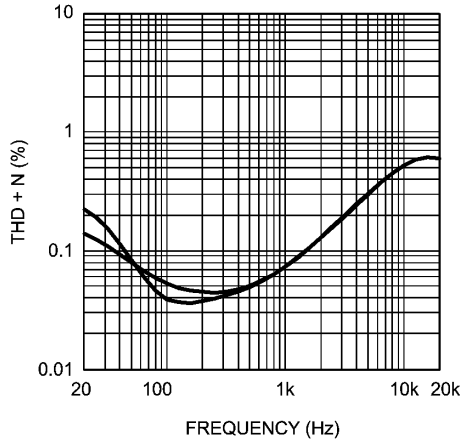

20105940

**THD+N vs Frequency**  
 $V_{DD} = 3.3V, R_L = 8\Omega, P_O = 250mW$   
 Mode 5

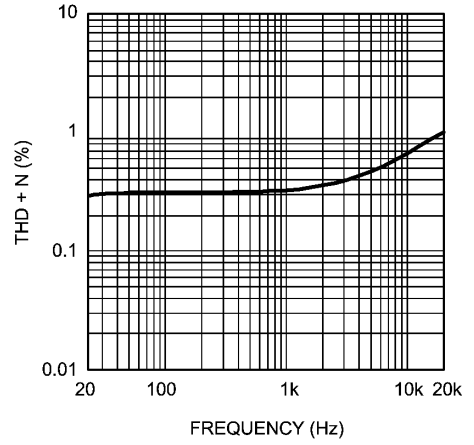

20105941

**THD+N vs Frequency**  
 $V_{DD} = 5V, R_L = 8\Omega, P_O = 500mW$   
 Mode 1, BTL

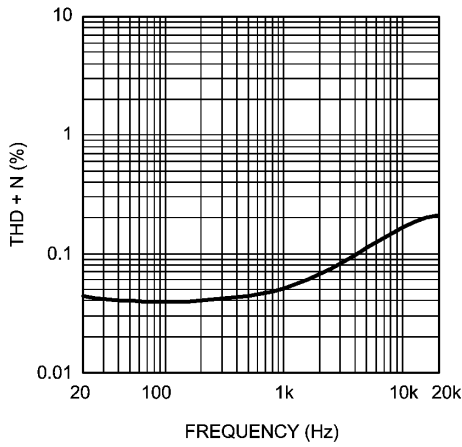

20105942

**THD+N vs Frequency**  
 $V_{DD} = 5V, R_L = 32\Omega, P_O = 30mW$   
 Mode 4, OCL

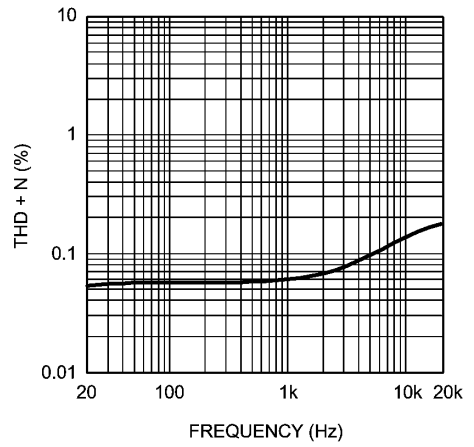

20105943

**THD+N vs Frequency**  
 $V_{DD} = 5V, R_L = 32\Omega, P_O = 30mW$   
 Mode 4, SE

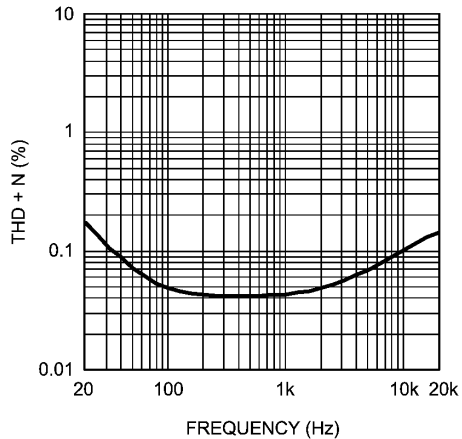

20105944

**THD+N vs Frequency**  
 $V_{DD} = 5V, R_L = 32\Omega, P_O = 30mW$   
 Mode 6, OCL

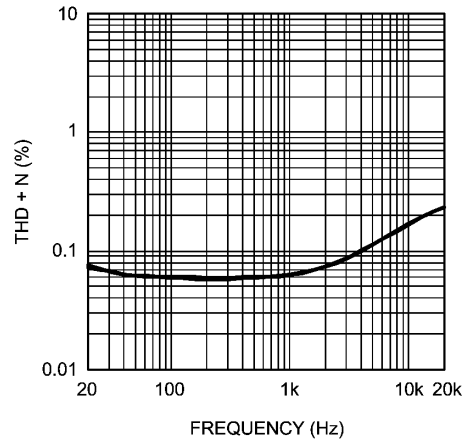

20105945

Typical Performance Characteristics (Continued)

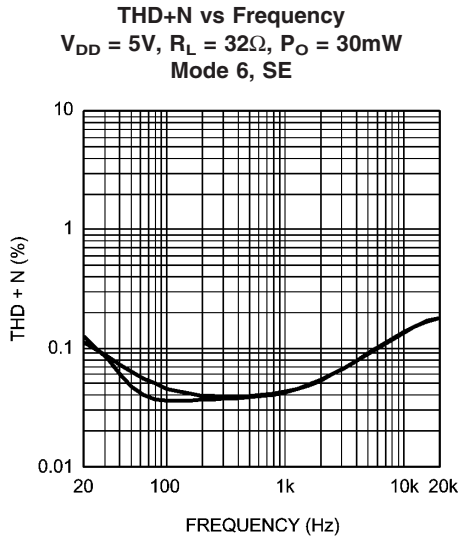

20105946

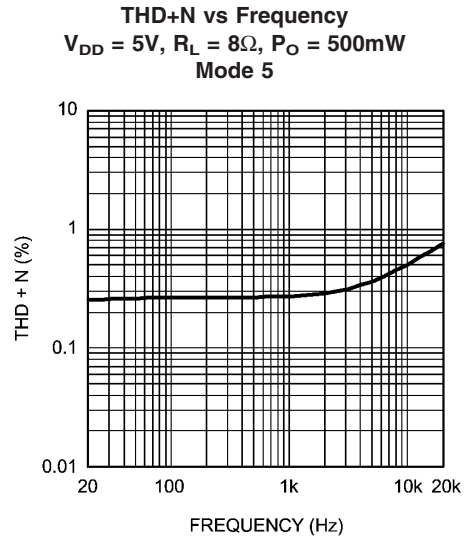

20105947

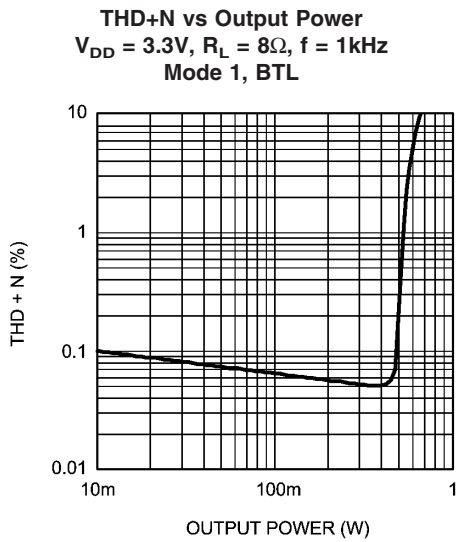

20105948

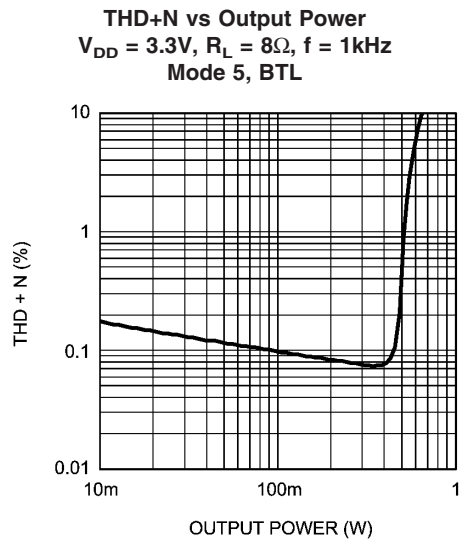

20105949

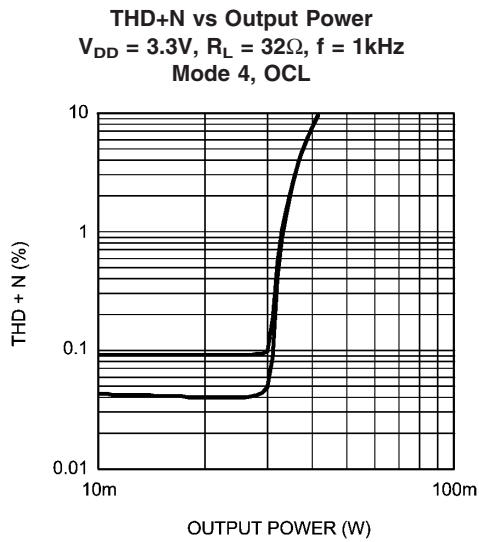

20105950

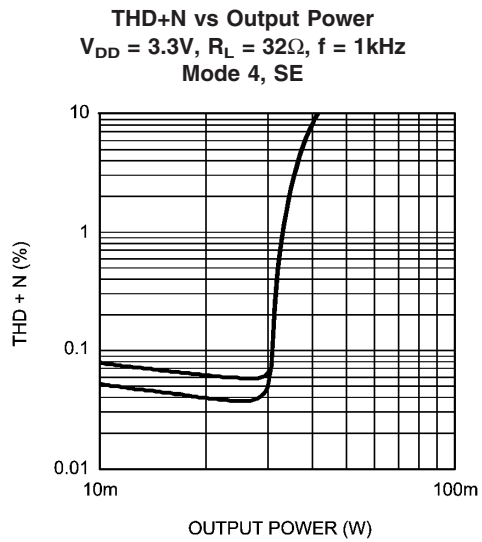

20105951

Typical Performance Characteristics (Continued)

**THD+N vs Output Power**  
 $V_{DD} = 3.3V, R_L = 32\Omega, f = 1kHz$   
 Mode 6, OCL

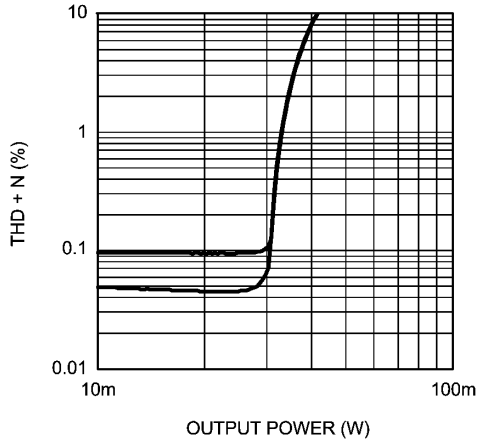

20105952

**THD+N vs Output Power**  
 $V_{DD} = 3.3V, R_L = 32\Omega, f = 1kHz$   
 Mode 6, SE

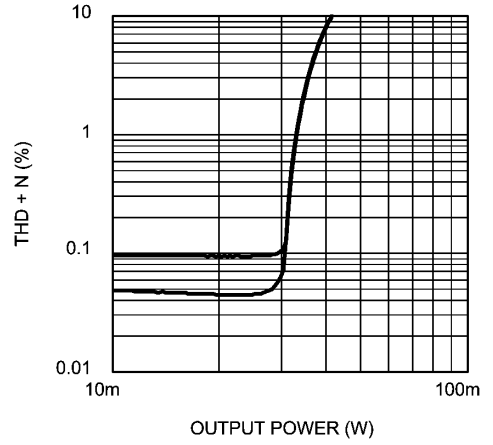

20105953

**THD+N vs Output Power**  
 $V_{DD} = 5V, R_L = 8\Omega, f = 1kHz$   
 Mode 1, BTL

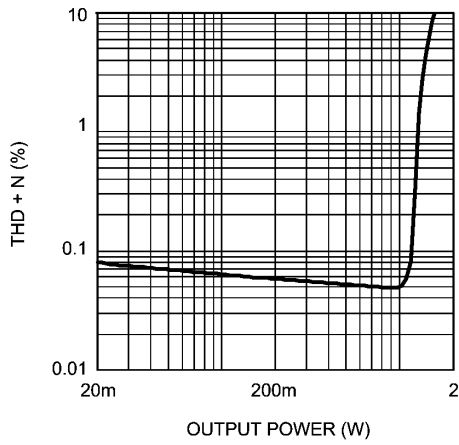

20105954

**THD+N vs Output Power**  
 $V_{DD} = 5V, R_L = 8\Omega, f = 1kHz$   
 Mode 5, BTL

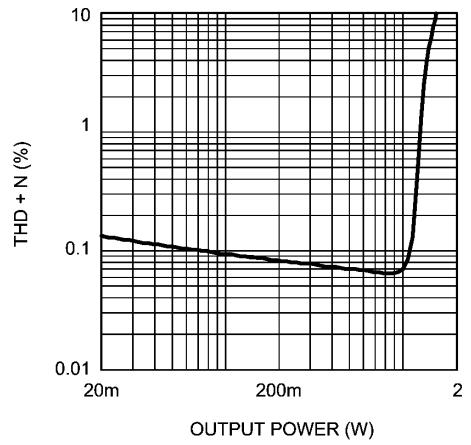

20105955

**THD+N vs Output Power**  
 $V_{DD} = 5V, R_L = 32\Omega, f = 1kHz$   
 Mode 4, OCL

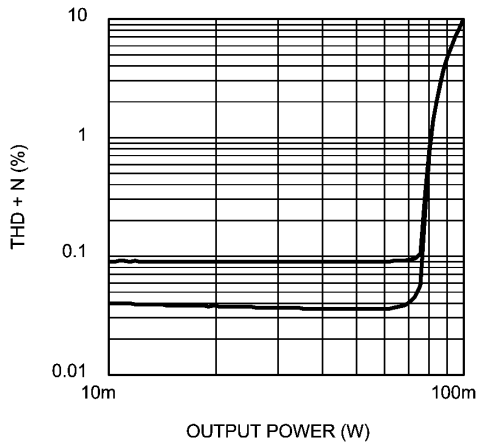

20105956

**THD+N vs Output Power**  
 $V_{DD} = 5V, R_L = 32\Omega, f = 1kHz$   
 Mode 4, SE

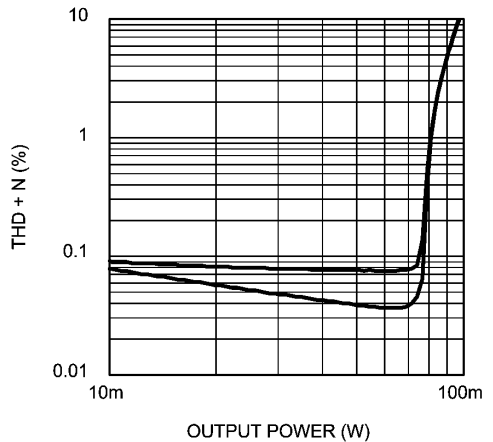

20105957

Typical Performance Characteristics (Continued)

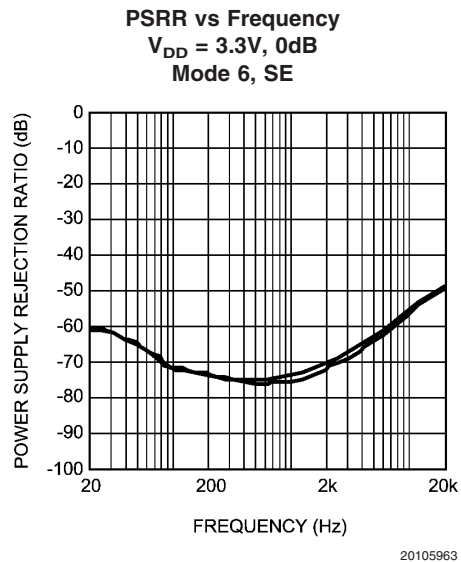
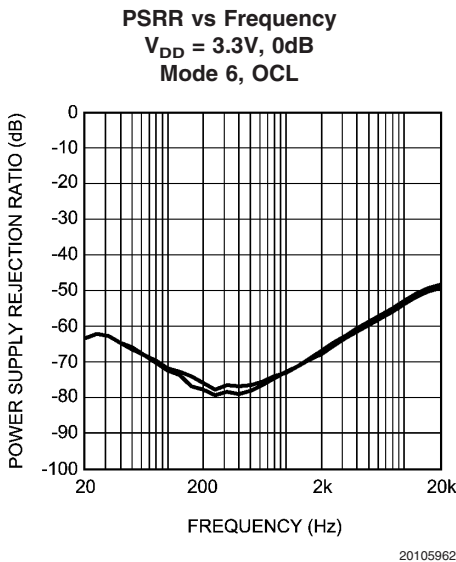
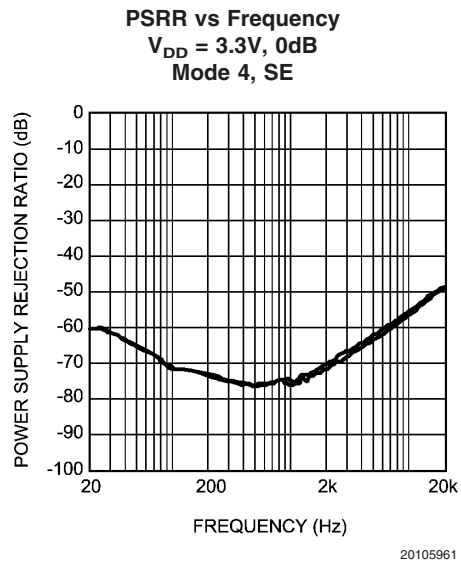
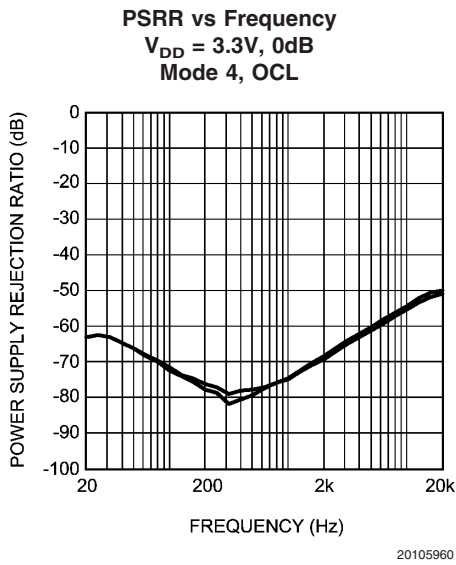
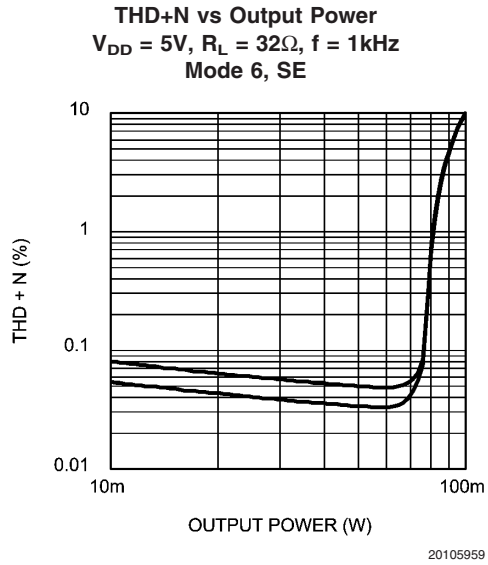
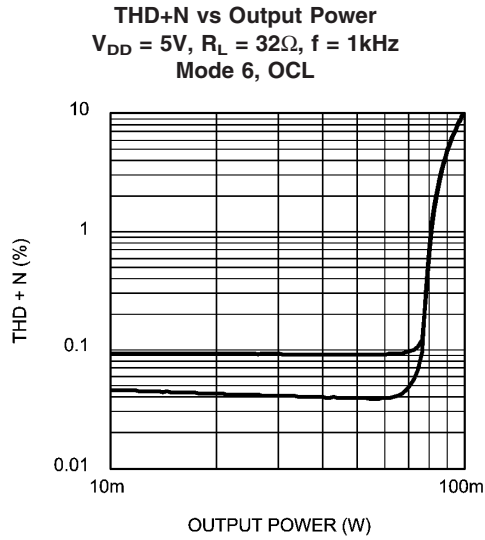

Typical Performance Characteristics (Continued)

**PSRR vs Frequency**  
 $V_{DD} = 3.3V, 6dB$   
 Mode 1, BTL

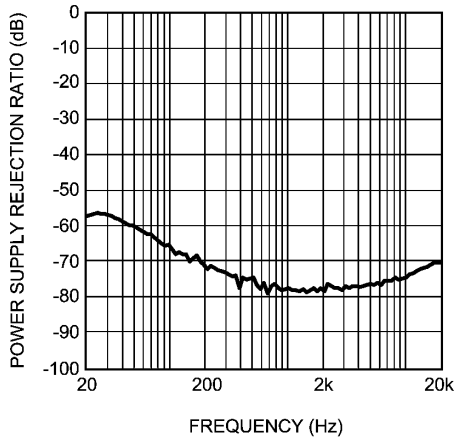

20105964

**PSRR vs Frequency**  
 $V_{DD} = 3.3V, 6dB$   
 Mode 5, BTL

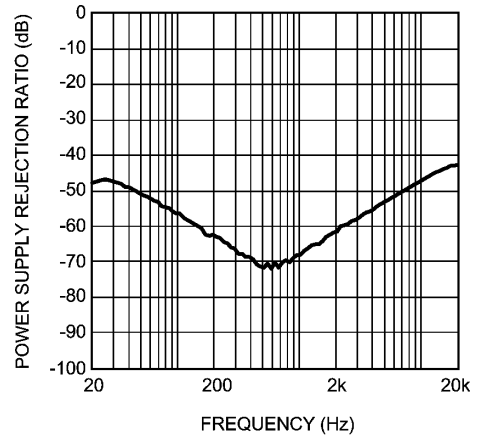

20105965

**Noise**  
 $V_{DD} = 3.3V, Mode 4, OCL$

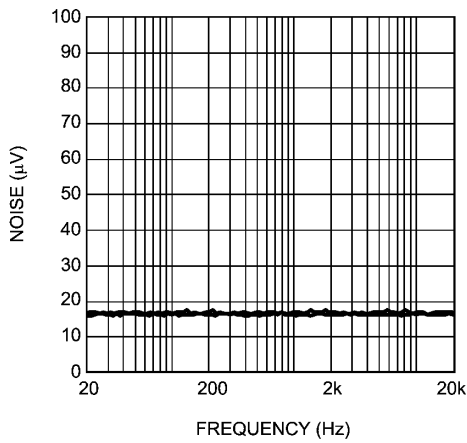

20105968

**Noise**  
 $V_{DD} = 3.3V, Mode 4, SE$

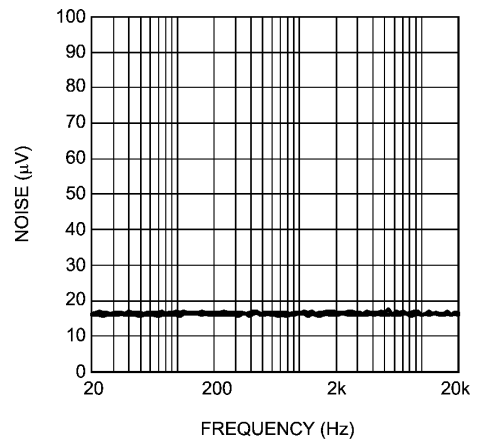

20105969

**Noise**  
 $V_{DD} = 3.3V, Mode 6, SE$

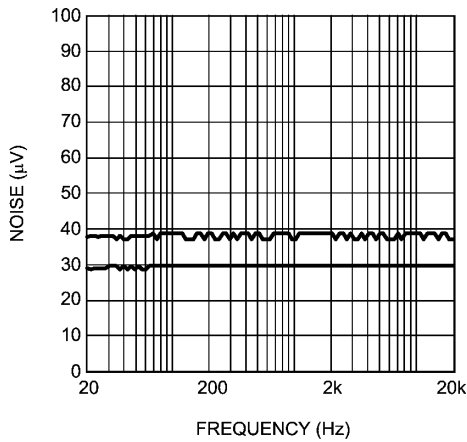

20105970

**Noise**  
 $V_{DD} = 3.3V, Mode 5, BTL$

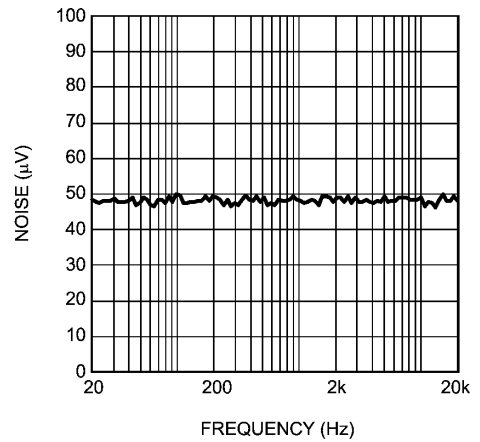

20105971

Typical Performance Characteristics (Continued)

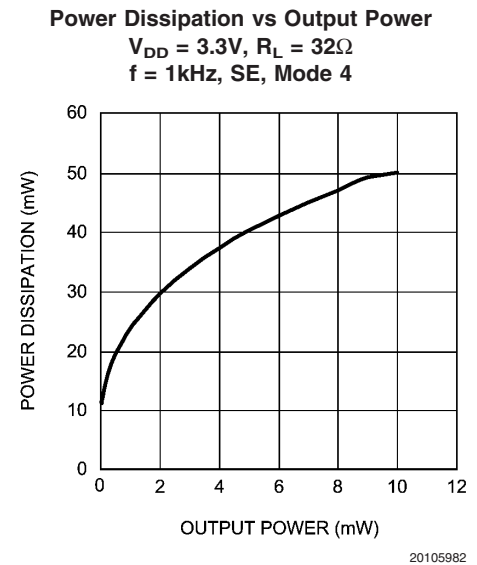
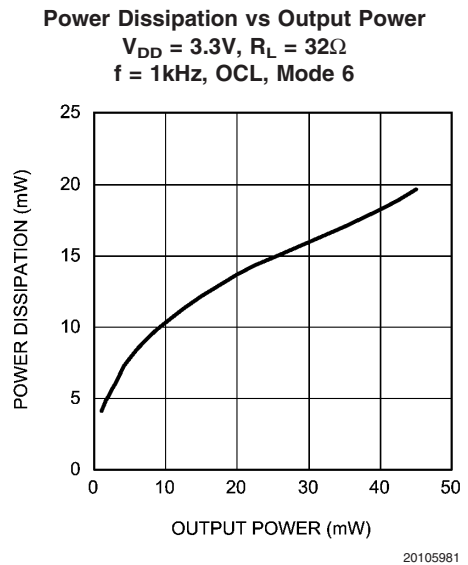
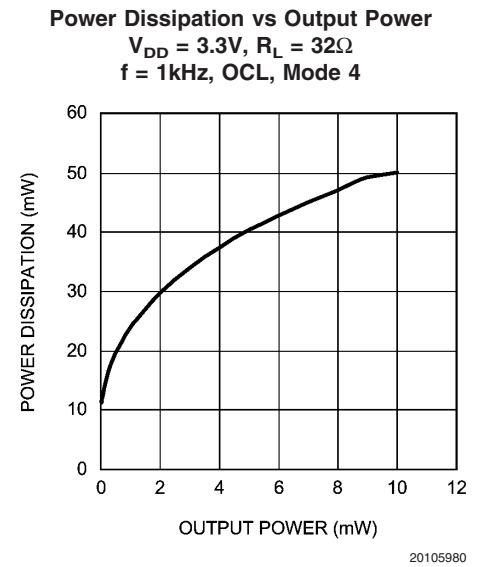
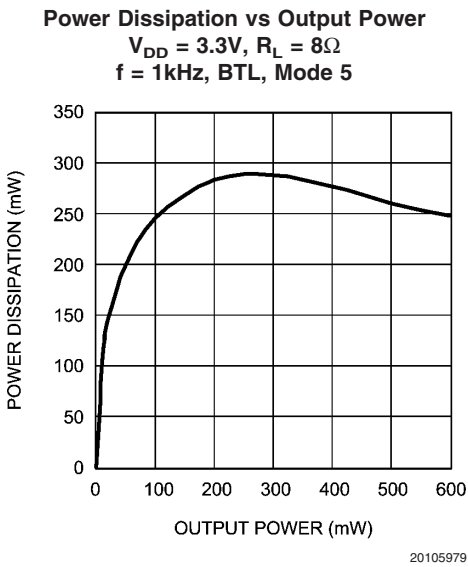
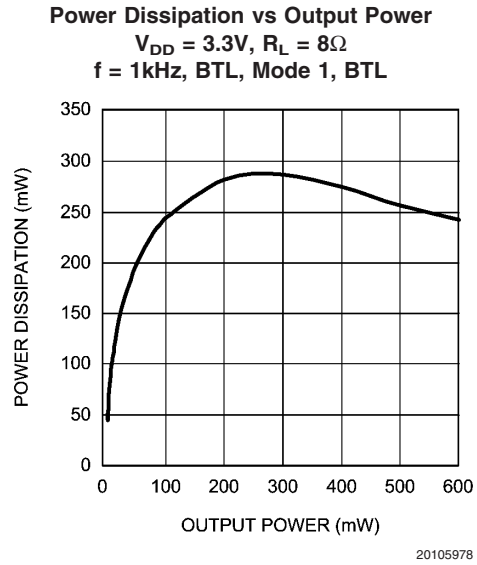
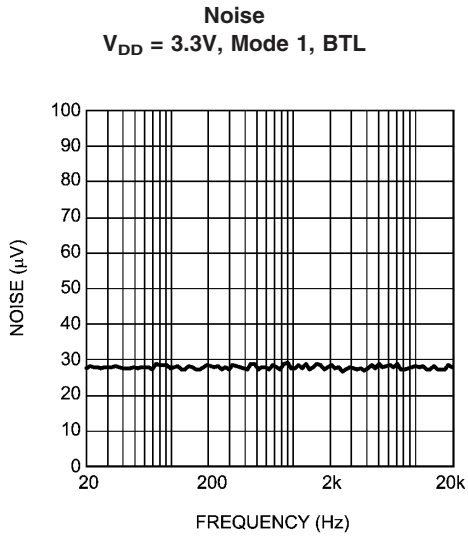



Typical Performance Characteristics (Continued)

Power Dissipation vs Output Power

$V_{DD} = 3.3V$ ,  $R_L = 32\Omega$   
 $f = 1kHz$ , SE, Mode 6

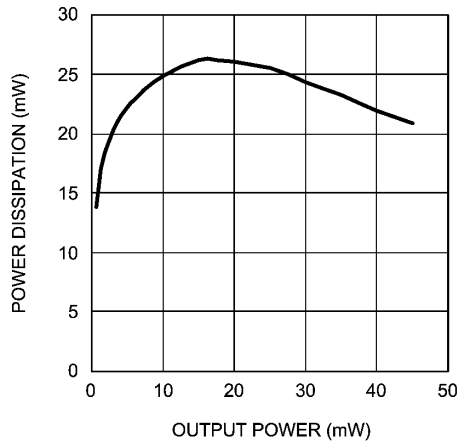

20105983

Power Dissipation vs Output Power

$V_{DD} = 5V$ ,  $R_L = 8\Omega$   
 $f = 1kHz$ , BTL, Mode 1

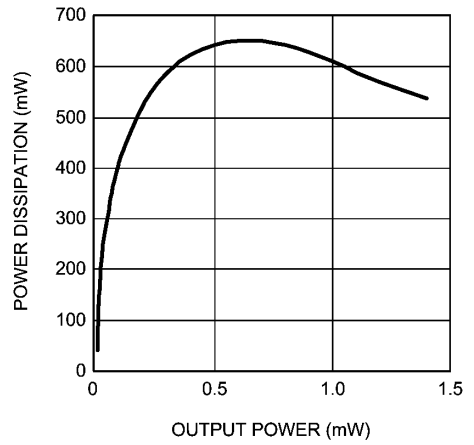

20105984

Power Dissipation vs Output Power

$V_{DD} = 5V$ ,  $R_L = 8\Omega$   
 $f = 1kHz$ , BTL, Mode 5

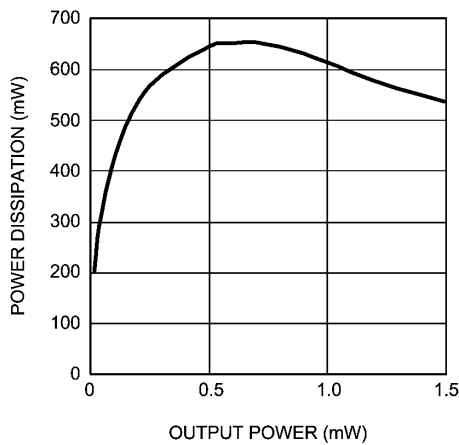

20105985

Power Dissipation vs Output Power

$V_{DD} = 5V$ ,  $R_L = 32\Omega$   
 $f = 1kHz$ , OCL, Mode 4

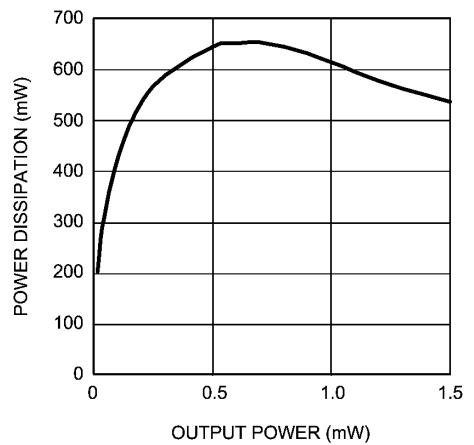

20105986

Power Dissipation vs Output Power

$V_{DD} = 5V$ ,  $R_L = 32\Omega$   
 $f = 1kHz$ , OCL, Mode 6

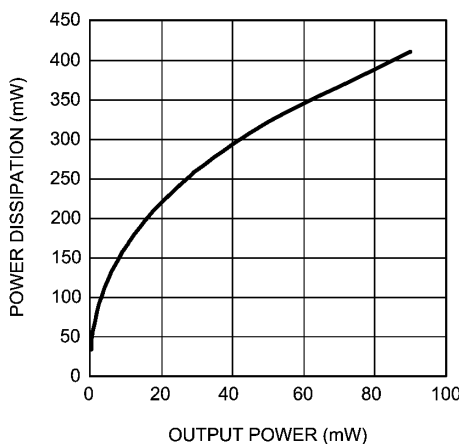

20105987

Power Dissipation vs Output Power

$V_{DD} = 5V$ ,  $R_L = 32\Omega$   
 $f = 1kHz$ , SE, Mode 4

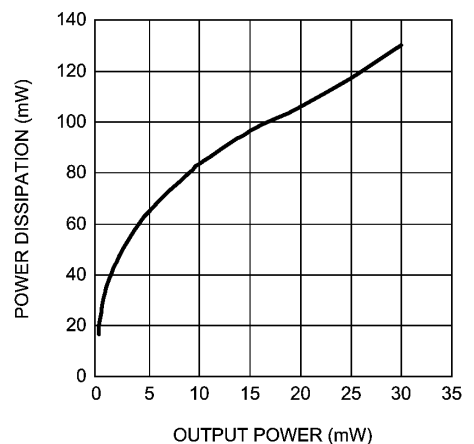

20105988

Typical Performance Characteristics (Continued)

Power Dissipation vs Output Power

$V_{DD} = 5V, R_L = 32\Omega$   
 $f = 1kHz, SE, Mode 6$

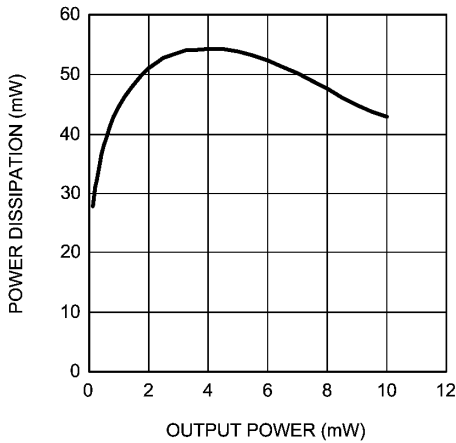

20105989

Crosstalk vs Frequency

$V_{DD} = 3.3V, R_L = 32\Omega, P_O = 12mW$   
 Right-Left, OCL, Mode 4

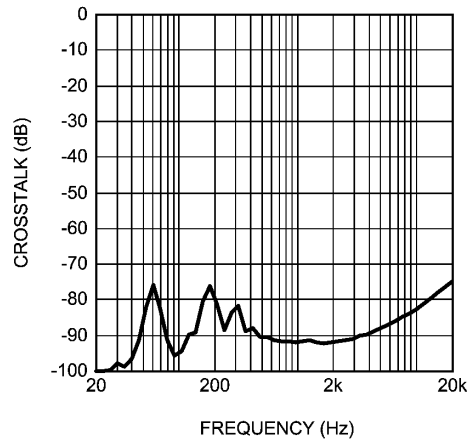

20105990

Crosstalk vs Frequency  
 $V_{DD} = 3.3V, R_L = 32\Omega, P_O = 12mW$   
 Right-Left, OCL, Mode 6

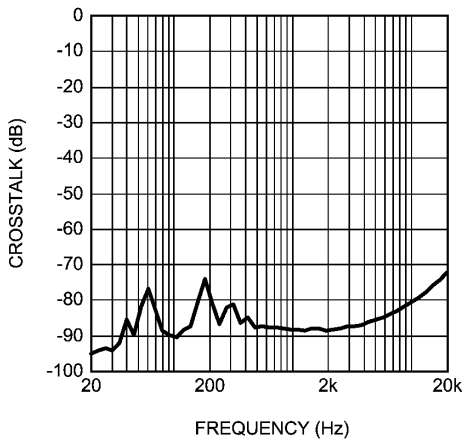

20105991

Crosstalk vs Frequency  
 $V_{DD} = 3.3V, R_L = 32\Omega, P_O = 12mW$   
 Right-Left, SE, Mode 4

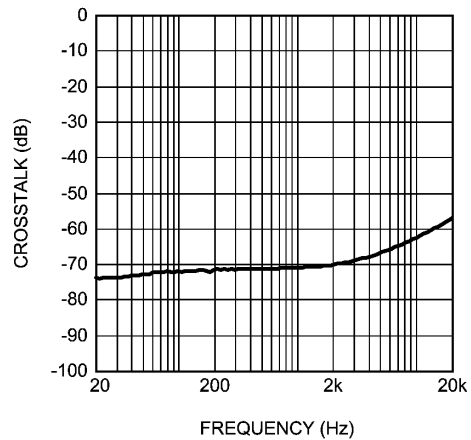

20105992

Crosstalk vs Frequency  
 $V_{DD} = 3.3V, R_L = 32\Omega, P_O = 12mW$   
 Right-Left, SE, Mode 6

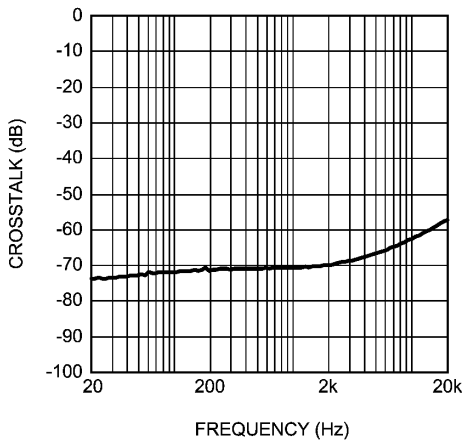

20105993

Supply Current vs Supply Voltage  
 $R_L = 8\Omega, Mode 1$

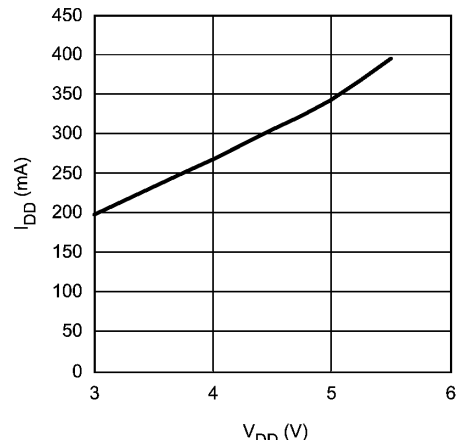

20105996

Typical Performance Characteristics (Continued)

Supply Current vs Supply Voltage  
 $R_L = 8\Omega$ , Mode 5

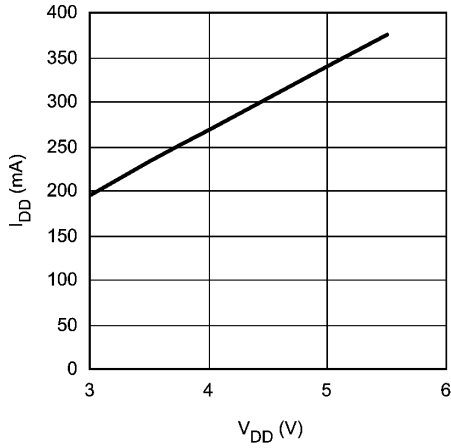

20105997

Supply Current vs Supply Voltage  
 $R_L = 32\Omega$ , OCL, Mode 4

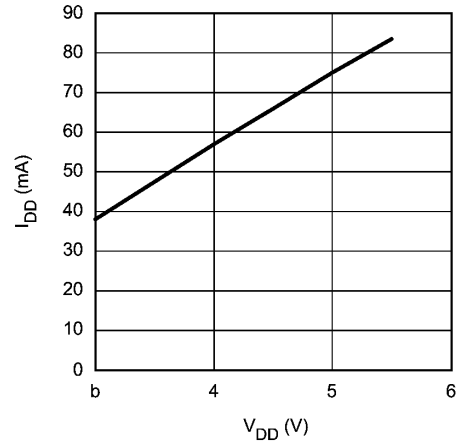

20105998

Supply Current vs Supply Voltage  
 $R_L = 32\Omega$ , OCL, Mode 6

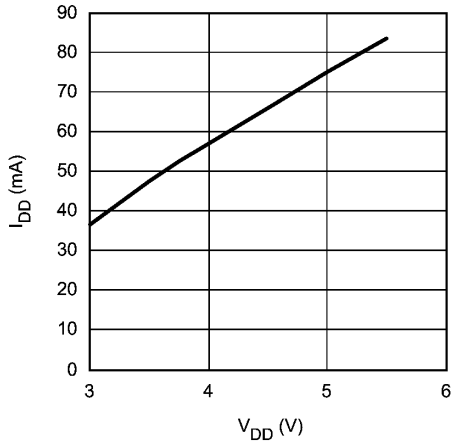

201059A0

Supply Current vs Supply Voltage  
 $R_L = 32\Omega$ , SE, Mode 4

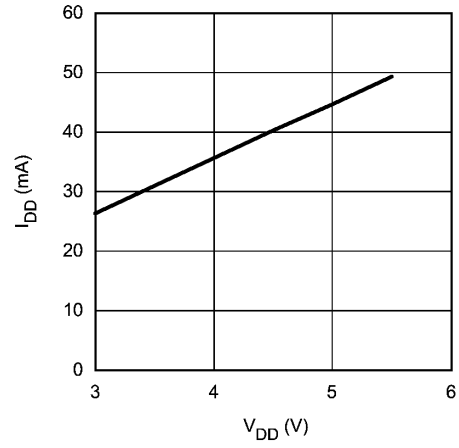

201059A1

Supply Current vs Supply Voltage  
 $R_L = 32\Omega$ , SE, Mode 6

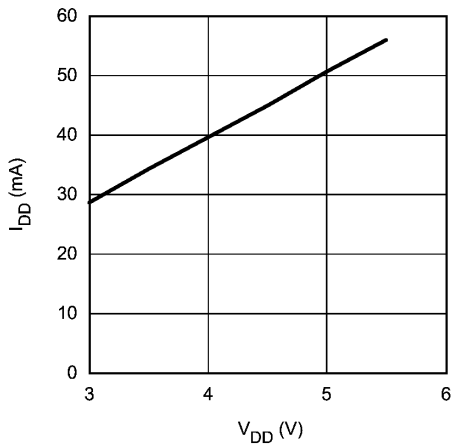

201059A2

Output Power vs Supply Voltage  
 $R_L = 8\Omega$ , Mode 1

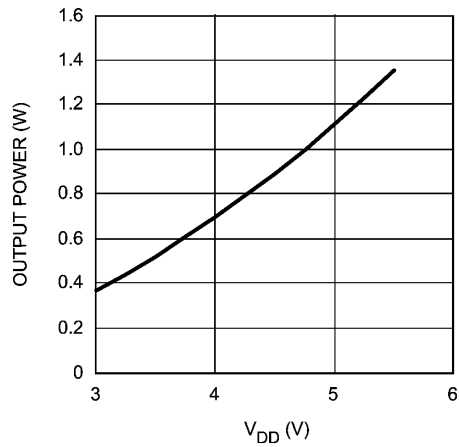

201059A3

Typical Performance Characteristics (Continued)

Output Power vs Supply Voltage  
 $R_L = 8\Omega$ , Mode 5

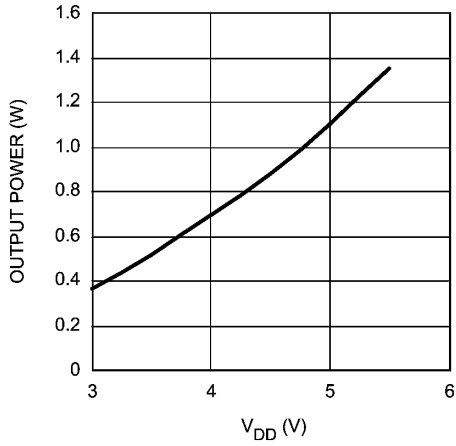

201059A4

Output Power vs Supply Voltage  
 $R_L = 32\Omega$ , Mode 4

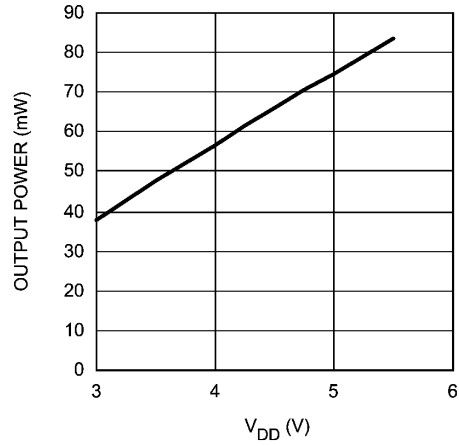

201059A5

Output Power vs Supply Voltage  
 $R_L = 32\Omega$ , OCL, Mode 6

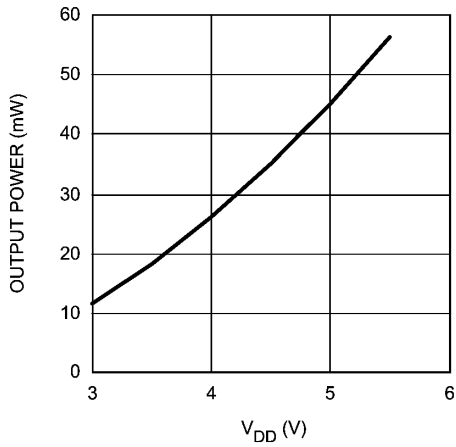

201059A6

Output Power vs Supply Voltage  
 $R_L = 32\Omega$ , SE, Mode 4

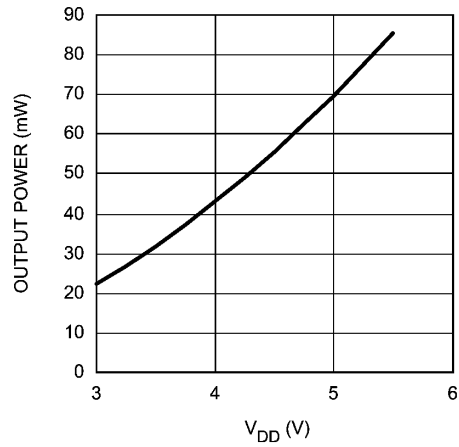

201059A7

Output Power vs Supply Voltage  
 $R_L = 32\Omega$ , SE, Mode 6

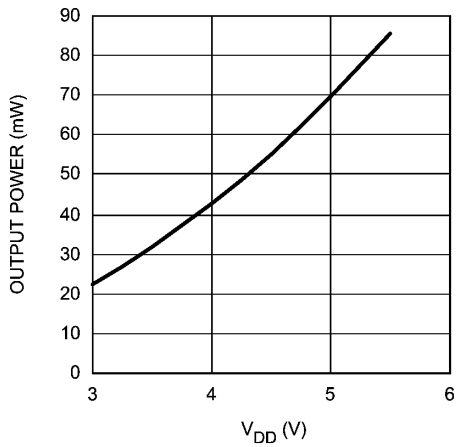

201059A8

## Application Information

### I<sup>2</sup>C PIN DESCRIPTION

SDA: This is the serial data input pin.

SCL: This is the clock input pin.

ID\_ENB: This is the address select input pin.

I<sup>2</sup>CSPI\_SEL: This is tied LOW for I<sup>2</sup>C mode.

### I<sup>2</sup>C COMPATIBLE INTERFACE

The LM4845 uses a serial bus which conforms to the I<sup>2</sup>C protocol to control the chip's functions with two wires: clock (SCL) and data (SDA). The clock line is uni-directional. The data line is bi-directional (open-collector). The maximum clock frequency specified by the I<sup>2</sup>C standard is 400kHz. In this discussion, the master is the controlling microcontroller and the slave is the LM4845.

The I<sup>2</sup>C address for the LM4845 is determined using the ID\_ENB pin. The LM4845's two possible I<sup>2</sup>C chip addresses are of the form 111110X<sub>1</sub>0 (binary), where X<sub>1</sub> = 0, if ID\_ENB is logic LOW; and X<sub>1</sub> = 1, if ID\_ENB is logic HIGH. If the I<sup>2</sup>C interface is used to address a number of chips in a system, the LM4845's chip address can be changed to avoid any possible address conflicts.

The bus format for the I<sup>2</sup>C interface is shown in Figure 3. The bus format diagram is broken up into six major sections:

The "start" signal is generated by lowering the data signal while the clock signal is HIGH. The start signal will alert all devices attached to the I<sup>2</sup>C bus to check the incoming address against their own address.

The 8-bit chip address is sent next, most significant bit first. The data is latched in on the rising edge of the clock. Each address bit must be stable while the clock level is HIGH.

For I<sup>2</sup>C interface operation, the I<sup>2</sup>CSPI\_SEL pin needs to be tied LOW (and tied high for SPI operation).

After the last bit of the address bit is sent, the master releases the data line HIGH (through a pull-up resistor). Then the master sends an acknowledge clock pulse. If the LM4845 has received the address correctly, then it holds the data line LOW during the clock pulse. If the data line is not held LOW during the acknowledge clock pulse, then the master should abort the rest of the data transfer to the LM4845.

The 8 bits of data are sent next, most significant bit first. Each data bit should be valid while the clock level is stable HIGH.

After the data byte is sent, the master must check for another acknowledge to see if the LM4845 received the data.

If the master has more data bytes to send to the LM4845, then the master can repeat the previous two steps until all data bytes have been sent.

The "stop" signal ends the transfer. To signal "stop", the data signal goes HIGH while the clock signal is HIGH. The data line should be held HIGH when not in use.

### I<sup>2</sup>C INTERFACE POWER SUPPLY PIN (I<sup>2</sup>CV<sub>DD</sub>)

The LM4845's I<sup>2</sup>C interface is powered up through the I<sup>2</sup>CV<sub>DD</sub> pin. The LM4845's I<sup>2</sup>C interface operates at a voltage level set by the I<sup>2</sup>CV<sub>DD</sub> pin which can be set independent to that of the main power supply pin V<sub>DD</sub>. This is ideal whenever logic levels for the I<sup>2</sup>C interface are dictated by a microcontroller or microprocessor that is operating at a lower supply voltage than the main battery of a portable system.

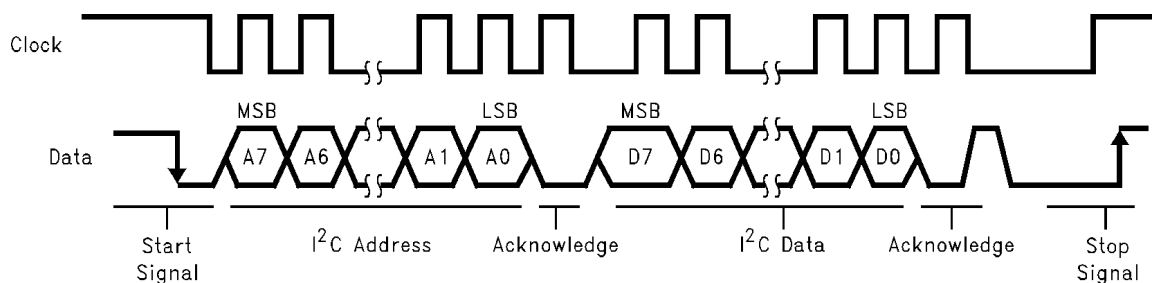

201059F5

FIGURE 3. I<sup>2</sup>C Bus Format

## Application Information (Continued)

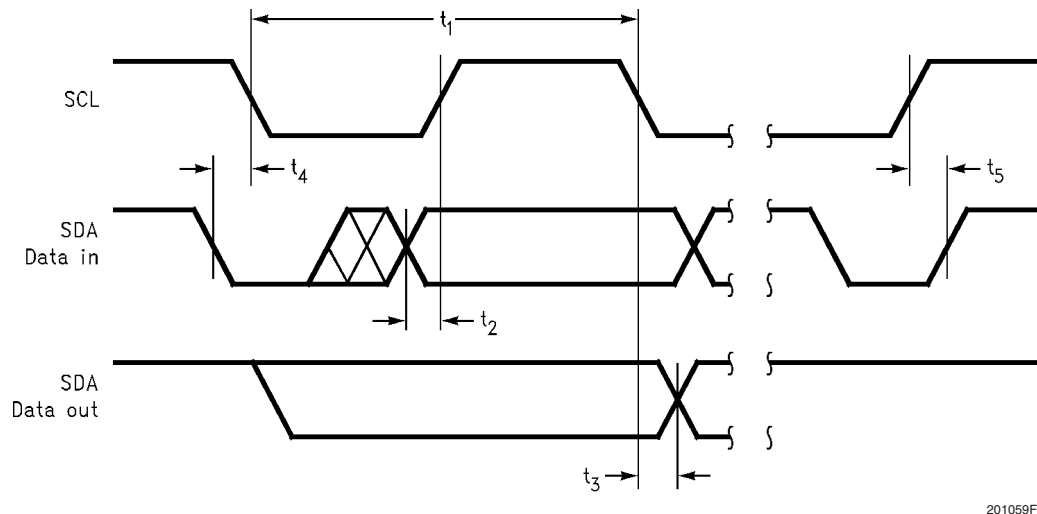

FIGURE 4. I<sup>2</sup>C Timing Diagram

### SPI DESCRIPTION

0. I<sup>2</sup>CSP<sub>I</sub>\_SEL: This pin is tied HIGH for SPI mode.

1. The data bits are transmitted with the MSB first.

2. The maximum clock rate is 1MHz for the CLK pin.

3. CLK must remain HIGH for at least 500ns ( $t_{CH}$ ) after the rising edge of CLK, and CLK must remain LOW for at least 500ns ( $t_{CL}$ ) after the falling edge of CLK.

4. The serial data bits are sampled at the rising edge of CLK. Any transition on DATA must occur at least 100ns ( $t_{DS}$ ) before the rising edge of CLK. Also, any transition on DATA must occur at least 100ns ( $t_{DH}$ ) after the rising edge of CLK and stabilize before the next rising edge of CLK.

5. ID\_ENB should be LOW only during serial data transmission.

6. ID\_ENB must be LOW at least 100ns ( $t_{ES}$ ) before the first rising edge of CLK, and ID\_ENB has to remain LOW at least 100ns ( $t_{EH}$ ) after the eighth rising edge of CLK.

7. If ID\_ENB remains HIGH for more than 100ns before all 8 bits are transmitted then the data latch will be aborted.

8. If ID\_ENB is LOW for more than 8 CLK pulses then only the first 8 data bits will be latched and activated when ID\_ENB transitions to logic-high.

9. ID\_ENB must remain HIGH for at least 100ns ( $t_{EL}$ ) to latch in the data.

10. Coincidental rising or falling edges of CLK and ID\_ENB are not allowed. If CLK is to be held HIGH after the data transmission, the falling edge of CLK must occur at least 100ns ( $t_{CS}$ ) before ID\_ENB transitions to LOW for the next set of data.

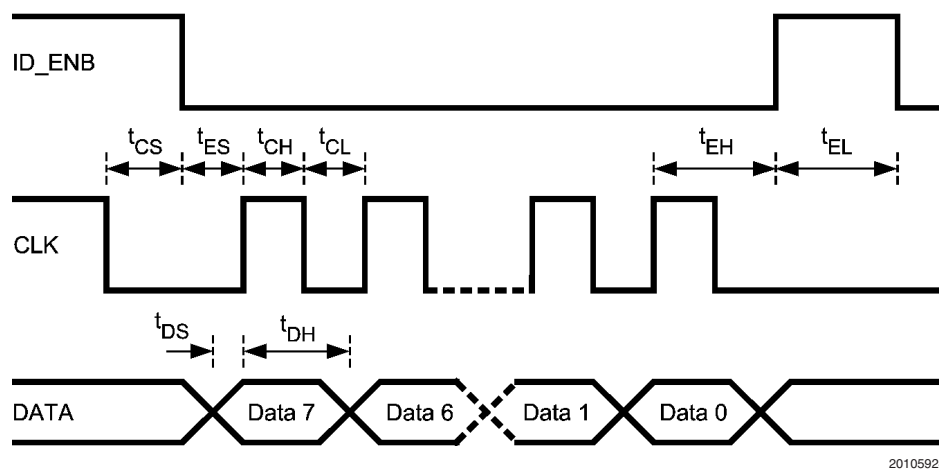

FIGURE 5. SPI Timing Diagram

## Application Information (Continued)

**TABLE 1. Chip Address**

	A7	A6	A5	A4	A3	A2	A1	A0
Chip Address	1	1	1	1	1	0	EC	0
ID_ENB = 0	1	1	1	1	1	0	0	0
ID_ENB = 1	1	1	1	1	1	0	1	0

**TABLE 2. Control Registers**

	D7	D6	D5	D4	D3	D2	D1	D0
Mode Control	0	0	0	0	OCL	MC2	MC1	MC0
Programmable 3D	0	1	0	0	N3D3	N3D2	N3D1	N3D0
Mono Volume Control	1	0	0	MVC4	MVC3	MVC2	MVC1	MVC0
Left Volume Control	1	1	0	LVC4	LVC3	LVC2	LVC1	LVC0
Right Volume Control	1	1	1	RVC4	RVC3	RVC2	RVC1	RVC0

1. Bits MVC0 — MVC4 control 32 step volume control for MONO input
2. Bits LVC0 — LVC4 control 32 step volume control for LEFT input
3. Bits RVC0 — RVC4 control 32 step volume control for RIGHT input
4. Bits MC0 — MC2 control 8 distinct modes
5. Bits N3D3, N3D2, N3D1, N3D0 control programmable 3D function
6. N3D0 turns the 3D function ON (N3D0 = 1) or OFF (N3D0 = 0), and N3D1 = 0 provides a "wider" aural effect or N3D1 = 1 a "narrower" aural effect
7. Bit OCL selects between SE with output capacitor (OCL = 0) or SE without output capacitors (OCL = 1). **Default is OCL = 0**
8. N3D1 selects between two different 3D configurations

**TABLE 3. Programmable National 3D Audio**

	N3D3	N3D2
Low	0	0
Medium	0	1
High	1	0
Maximum	1	1

**TABLE 4. Output Mode Selection**

Output Mode Number	MC2	MC1	MC0	Handsfree Speaker Output	Right HP Output	Left HP Output
0	0	0	0	SD	SD	SD
1	0	0	1	$2 \times G_P \times P$	MUTE	MUTE
2	0	1	0	SD	$G_P \times P$	$G_P \times P$
3	0	1	1	$2 \times (G_L \times L + G_R \times R)$	MUTE	MUTE
4	1	0	0	SD	$G_R \times R$	$G_L \times L$
5	1	0	1	$2 \times (G_L \times L + G_R \times R + G_P \times P)$	MUTE	MUTE
6	1	1	0	SD	$G_R \times R + G_P \times P$	$G_L \times L + G_P \times P$
7	1	1	1	$2 \times G_P \times P$	$G_R \times R + G_P \times P$	$G_L \times L + G_P \times P$

On initial POWER ON, the default mode is 000

P = Phone in

R =  $R_{IN}$

L =  $L_{IN}$

SD = Shutdown

MUTE = Mute Mode

$G_P$  = Phone In (Mono) volume control gain

$G_R$  = Right stereo volume control gain

$G_L$  = Left stereo volume control gain

# Application Information (Continued)

**TABLE 5. Volume Control Table**

Volume Step	xVC4	xVC3	xVC2	xVC1	xVC0	Headphone Gain, dB	Speaker Gain, dB (BTL)
1	0	0	0	0	0	-54.00	-48.00
2	0	0	0	0	1	-46.50	-40.50
3	0	0	0	1	0	-40.50	-34.50
4	0	0	0	1	1	-34.50	-28.50
5	0	0	1	0	0	-30.00	-24.00
6	0	0	1	0	1	-27.00	-21.00
7	0	0	1	1	0	-24.00	-18.00
8	0	0	1	1	1	-21.00	-15.00
9	0	1	0	0	0	-18.00	-12.00
10	0	1	0	0	1	-15.00	-9.00
11	0	1	0	1	0	-13.50	-7.50
12	0	1	0	1	1	-12.00	-6.00
13	0	1	1	0	0	-10.50	-4.50
14	0	1	1	0	1	-9.00	-3.00
15	0	1	1	1	0	-7.50	-1.50
16	0	1	1	1	1	-6.00	0.00
17	1	0	0	0	0	-4.50	1.50
18	1	0	0	0	1	-3.00	3.00
19	1	0	0	1	0	-1.50	4.50
20	1	0	0	1	1	0.00	6.00
21	1	0	1	0	0	1.50	7.50
22	1	0	1	0	1	3.00	9.00
23	1	0	1	1	0	4.50	10.50
24	1	0	1	1	1	6.00	12.00
25	1	1	0	0	0	7.50	13.50
26	1	1	0	0	1	9.00	15.00
27	1	1	0	1	0	10.50	16.50
28	1	1	0	1	1	12.00	18.00
29	1	1	1	0	0	13.50	19.50
30	1	1	1	0	1	15.00	21.00
31	1	1	1	1	0	16.50	22.50
32	1	1	1	1	1	18.00	24.00

1. x = M, L, or R

2. Gain / Attenuation is from input to output



## Application Information (Continued)

### NATIONAL 3D ENHANCEMENT

The LM4845 features a stereo headphone, 3D audio enhancement effect that widens the perceived soundstage from a stereo audio signal. The 3D audio enhancement creates a perceived spatial effect optimized for stereo headphone listening. The LM4845 can be programmed for a “narrow” or “wide” soundstage perception. The narrow soundstage has a more focused approaching sound direction, while the wide soundstage has a spatial, theater-like effect. Within each of these two modes, four discrete levels of 3D effect that can be programmed: low, medium, high, and maximum (Table 2), each level with an ever increasing aural effect, respectively. The difference between each level is 3dB.

The external capacitors, shown in Figure 6, are required to enable the 3D effect. The value of the capacitors set the cutoff frequency of the 3D effect, as shown by Equations 1 and 2. Note that the internal 20kΩ resistor is nominal ( $\pm 25\%$ ).

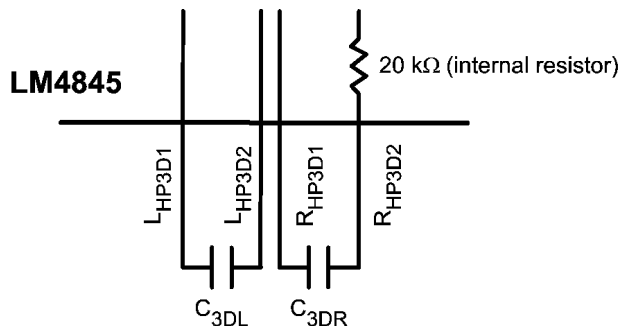

FIGURE 6. External 3D Effect Capacitors

$$f_{3DL(-3dB)} = 1 / 2\pi * 20k\Omega * C_{3DL} \quad (1)$$

$$f_{3DR(-3dB)} = 1 / 2\pi * 20k\Omega * C_{3DR} \quad (2)$$

Optional resistors  $R_{3DL}$  and  $R_{3DR}$  can also be added (Figure 7) to affect the -3dB frequency and 3D magnitude.

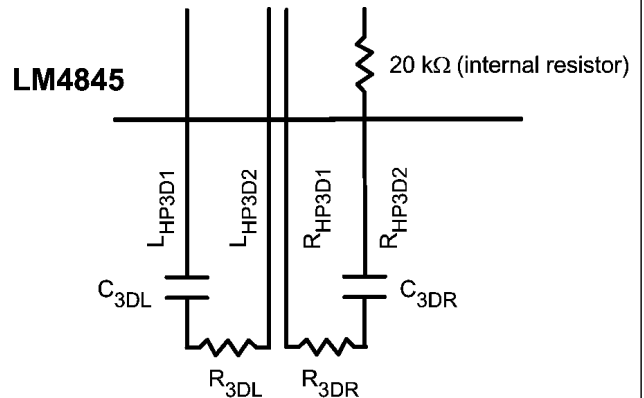

FIGURE 7. External RC Network with Optional  $R_{3DL}$  and  $R_{3DR}$  Resistors

$$f_{3DL(-3dB)} = 1 / 2\pi * (20k\Omega + R_{3DL}) * C_{3DL} \quad (3)$$

$$f_{3DR(-3dB)} = 1 / 2\pi * (20k\Omega + R_{3DR}) * C_{3DR} \quad (4)$$

$\Delta AV$  (change in AC gain) =  $1 / 1 + M$ , where M represents some ratio of the nominal internal resistor, 20kΩ (see example below).

$$f_{3dB(3D)} = 1 / 2\pi (1 + M)(20k\Omega * C_{3D}) \quad (5)$$

$$C_{Equivalent(new)} = C_{3D} / 1 + M \quad (6)$$

TABLE 6. Pole Locations

$R_{3D}$ (kΩ) (optional)	$C_{3D}$ (nF)	M	$\Delta AV$ (dB)	f-3dB (3D) (Hz)	Value of $C_{3D}$ to keep same pole location (nF)	new Pole Location (Hz)
0	68	0	0	117		
1	68	0.05	-0.4	111	64.8	117
5	68	0.25	-1.9	94	54.4	117
10	68	0.50	-3.5	78	45.3	117
20	68	1.00	-6.0	59	34.0	117

### PCB LAYOUT AND SUPPLY REGULATION CONSIDERATIONS FOR DRIVING 8Ω LOAD

Power dissipated by a load is a function of the voltage swing across the load and the load's impedance. As load impedance decreases, load dissipation becomes increasingly dependent on the interconnect (PCB trace and wire) resistance between the amplifier output pins and the load's connections. Residual trace resistance causes a voltage drop, which results in power dissipated in the trace and not in the load as desired. For example, 0.1Ω trace resistance reduces

the output power dissipated by an 8Ω load from 158.3mW to 156.4mW. The problem of decreased load dissipation is exacerbated as load impedance decreases. Therefore, to maintain the highest load dissipation and widest output voltage swing, PCB traces that connect the output pins to a load must be as wide as possible.

Poor power supply regulation adversely affects maximum output power. A poorly regulated supply's output voltage decreases with increasing load current. Reduced supply voltage causes decreased headroom, output signal clipping,

## Application Information (Continued)

and reduced output power. Even with tightly regulated supplies, trace resistance creates the same effects as poor supply regulation. Therefore, making the power supply traces as wide as possible helps maintain full output voltage swing.

### BRIDGE CONFIGURATION EXPLANATION

The LM4845 drives a load, such as a speaker, connected between outputs, MONO+ and MONO-.

This results in both amplifiers producing signals identical in magnitude, but 180° out of phase. Taking advantage of this phase difference, a load is placed between MONO- and MONO+ and driven differentially (commonly referred to as "bridge mode"). This results in a differential or BTL gain of:

$$A_{VD} = 2(R_f / R_i) = 2 \quad (7)$$

Bridge mode amplifiers are different from single-ended amplifiers that drive loads connected between a single amplifier's output and ground. For a given supply voltage, bridge mode has a distinct advantage over the single-ended configuration: its differential output doubles the voltage swing across the load. Theoretically, this produces four times the output power when compared to a single-ended amplifier under the same conditions. This increase in attainable output power assumes that the amplifier is not current limited and that the output signal is not clipped.

Another advantage of the differential bridge output is no net DC voltage across the load. This is accomplished by biasing MONO- and MONO+ outputs at half-supply. This eliminates the coupling capacitor that single supply, single-ended amplifiers require. Eliminating an output coupling capacitor in a typical single-ended configuration forces a single-supply amplifier's half-supply bias voltage across the load. This increases internal IC power dissipation and may permanently damage loads such as speakers.

### POWER DISSIPATION

Power dissipation is a major concern when designing a successful single-ended or bridged amplifier.

A direct consequence of the increased power delivered to the load by a bridge amplifier is higher internal power dissipation. The LM4845 has a pair of bridged-tied amplifiers driving a handsfree speaker, MONO. The maximum internal power dissipation operating in the bridge mode is twice that of a single-ended amplifier. From Equation (8), assuming a 5V power supply and an 8Ω load, the maximum MONO power dissipation is 634mW.

$$P_{\text{DMAX-SPKROUT}} = 4(V_{\text{DD}})^2 / (2\pi^2 R_L): \text{ Bridge Mode} \quad (8)$$

The LM4845 also has a pair of single-ended amplifiers driving stereo headphones, R<sub>OUT</sub> and L<sub>OUT</sub>. The maximum internal power dissipation for R<sub>OUT</sub> and L<sub>OUT</sub> is given by equation (9) and (10). From Equations (9) and (10), assuming a 5V power supply and a 32Ω load, the maximum power dissipation for L<sub>OUT</sub> and R<sub>OUT</sub> is 40mW, or 80mW total.

$$P_{\text{DMAX-LOUT}} = (V_{\text{DD}})^2 / (2\pi^2 R_L): \text{ Single-ended Mode} \quad (9)$$

$$P_{\text{DMAX-ROUT}} = (V_{\text{DD}})^2 / (2\pi^2 R_L): \text{ Single-ended Mode} \quad (10)$$

The maximum internal power dissipation of the LM4845 occurs when all 3 amplifiers pairs are simultaneously on; and is given by Equation (11).

$$P_{\text{DMAX-TOTAL}} = P_{\text{DMAX-SPKROUT}} + P_{\text{DMAX-LOUT}} + P_{\text{DMAX-ROUT}} \quad (11)$$

The maximum power dissipation point given by Equation (11) must not exceed the power dissipation given by Equation (12):

$$P_{\text{DMAX}} = (T_{\text{JMAX}} - T_{\text{A}}) / \theta_{\text{JA}} \quad (12)$$

The LM4845's T<sub>JMAX</sub> = 150°C. In the ITL package, the LM4845's θ<sub>JA</sub> is 65°C/W. At any given ambient temperature T<sub>A</sub>, use Equation (12) to find the maximum internal power dissipation supported by the IC packaging. Rearranging Equation (12) and substituting P<sub>DMAX-TOTAL</sub> for P<sub>DMAX</sub> results in Equation (13). This equation gives the maximum ambient temperature that still allows maximum stereo power dissipation without violating the LM4845's maximum junction temperature.

$$T_{\text{A}} = T_{\text{JMAX}} - P_{\text{DMAX-TOTAL}} \theta_{\text{JA}} \quad (13)$$

For a typical application with a 5V power supply and an 8Ω load, the maximum ambient temperature that allows maximum stereo power dissipation without exceeding the maximum junction temperature is approximately 104°C for the ITL package.

$$T_{\text{JMAX}} = P_{\text{DMAX-TOTAL}} \theta_{\text{JA}} + T_{\text{A}} \quad (14)$$

Equation (14) gives the maximum junction temperature T<sub>JMAX</sub>. If the result violates the LM4845's 150°C, reduce the maximum junction temperature by reducing the power supply voltage or increasing the load resistance. Further allowance should be made for increased ambient temperatures.

The above examples assume that a device is a surface mount part operating around the maximum power dissipation point. Since internal power dissipation is a function of output power, higher ambient temperatures are allowed as output power or duty cycle decreases. If the result of Equation (11) is greater than that of Equation (12), then decrease the supply voltage, increase the load impedance, or reduce the ambient temperature. If these measures are insufficient, a heat sink can be added to reduce θ<sub>JA</sub>. The heat sink can be created using additional copper area around the package, with connections to the ground pin(s), supply pin and amplifier output pins. External, solder attached SMT heatsinks such as the Thermalloy 7106D can also improve power dissipation. When adding a heat sink, the θ<sub>JA</sub> is the sum of θ<sub>JC</sub>, θ<sub>CS</sub>, and θ<sub>SA</sub>. (θ<sub>JC</sub> is the junction-to-case thermal impedance, θ<sub>CS</sub> is the case-to-sink thermal impedance, and θ<sub>SA</sub> is the sink-to-ambient thermal impedance). Refer to the Typical Performance Characteristics curves for power dissipation information at lower output power levels.

### POWER SUPPLY BYPASSING

As with any power amplifier, proper supply bypassing is critical for low noise performance and high power supply rejection. Applications that employ a 5V regulator typically use a 1μF in parallel with a 0.1μF filter capacitors to stabilize the regulator's output, reduce noise on the supply line, and improve the supply's transient response. However, their presence does not eliminate the need for a local 1.1μF tantalum bypass capacitance connected between the

## Application Information (Continued)

LM4845's supply pins and ground. Keep the length of leads and traces that connect capacitors between the LM4845's power supply pin and ground as short as possible. Connecting a 2.2 $\mu$ F capacitor,  $C_B$ , between the BYPASS pin and ground improves the internal bias voltage's stability and improves the amplifier's PSRR. The PSRR improvements increase as the bypass pin capacitor value increases. Too large, however, increases turn-on time and can compromise the amplifier's click and pop performance. The selection of bypass capacitor values, especially  $C_B$ , depends on desired PSRR requirements, click and pop performance (as explained in the section, Proper Selection of External Components), system cost, and size constraints.

### SELECTING EXTERNAL COMPONENTS

#### Input Capacitor Value Selection

Amplifying the lowest audio frequencies requires high value input coupling capacitor ( $C_i$  in Figures 1 & 2). A high value capacitor can be expensive and may compromise space efficiency in portable designs. In many cases, however, the speakers used in portable systems, whether internal or external, have little ability to reproduce signals below 150Hz. Applications using speakers with this limited frequency response reap little improvement by using large input capacitor.

The internal input resistor ( $R_i$ ), nominal 20k $\Omega$ , and the input capacitor ( $C_i$ ) produce a high pass filter cutoff frequency that is found using Equation (15).

$$f_c = 1 / (2\pi R_i C_i) \quad (15)$$

As an example when using a speaker with a low frequency limit of 150Hz,  $C_i$ , using Equation (15) is 0.053 $\mu$ F. The 0.22 $\mu$ F  $C_i$  shown in *Figure 1* allows the LM4845 to drive high efficiency, full range speaker whose response extends below 40Hz.

#### Bypass Capacitor Value Selection

Besides minimizing the input capacitor size, careful consideration should be paid to value of  $C_B$ , the capacitor connected to the BYPASS bump. Since  $C_B$  determines how fast the LM4845 settles to quiescent operation, its value is critical when minimizing turn-on pops. The slower the LM4845's outputs ramp to their quiescent DC voltage (nominally  $V_{DD}/2$ ), the smaller the turn-on pop. Choosing  $C_B$  equal to 1.0 $\mu$ F along with a small value of  $C_i$  (in the range of 0.1 $\mu$ F to 0.39 $\mu$ F), produces a click-less and pop-less shutdown function. As discussed above, choosing  $C_i$  no larger than necessary for the desired bandwidth helps minimize clicks and pops.  $C_B$ 's value should be in the range of 5 times to 7 times the value of  $C_i$ . This ensures that output transients are eliminated when power is first applied or the LM4845 resumes operation after shutdown.

# Application Information (Continued)

## LM4845 ITL DEMO BOARD ARTWORK

### Top Overlay

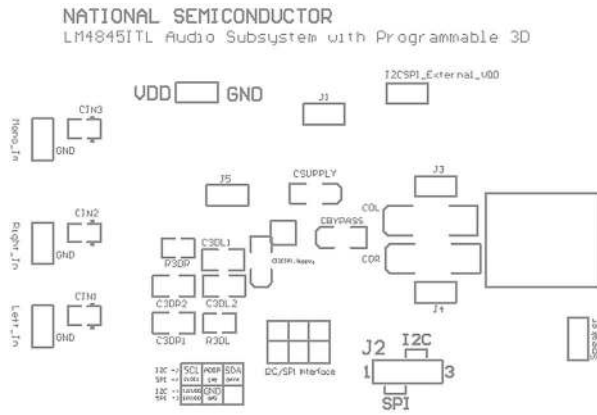

	J5	J4	J3	J2	J1
SE	SHORT	OPEN	OPEN		
DCL	OPEN	SHORT	SHORT		
I2C				2-3	
SPI				1-2	
I2CSPi_VDD					SHORT
I2CSPi_External_VDD					OPEN

201059E0

### Top Layer

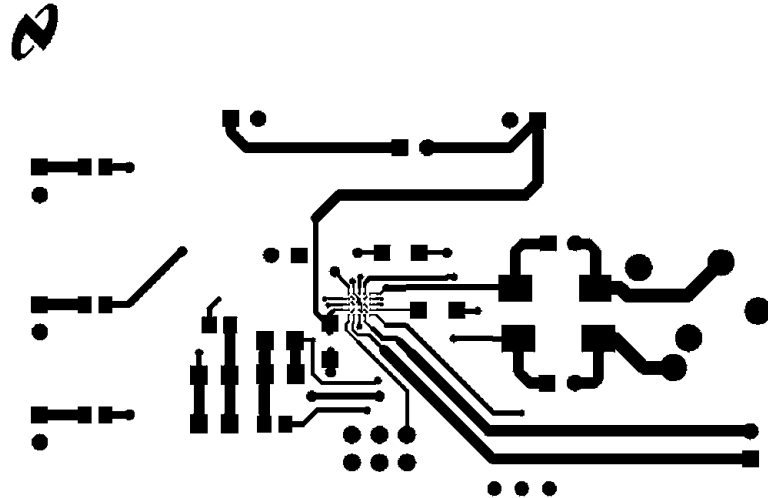

20105938

# Application Information (Continued)

Bottom Layer

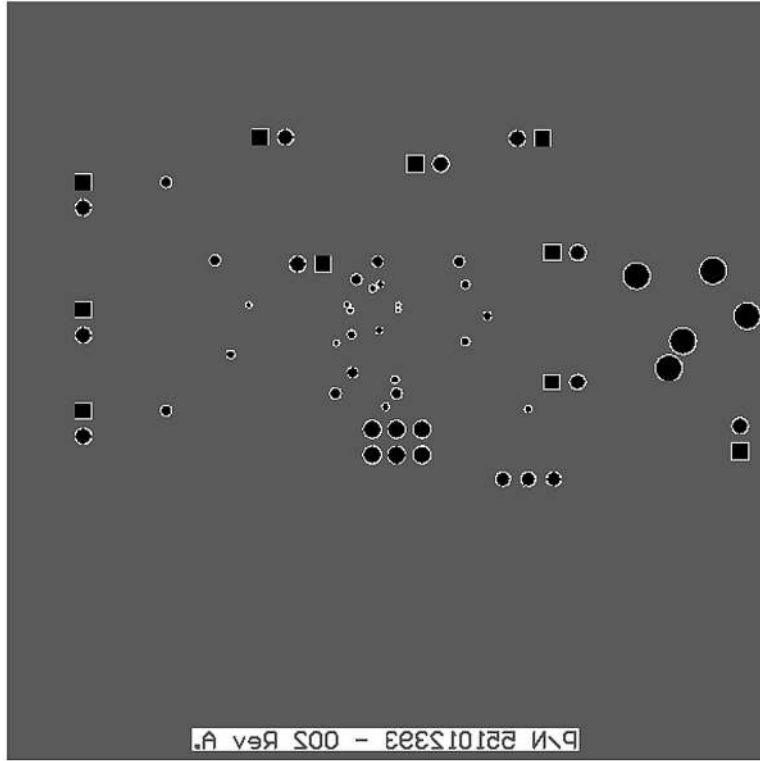

20105937

## Revision History

Rev	Date	Description
1.0	11/08/05	Fixed some typos, then re-released D/S to the WEB (per Allan).
1.1	12/21/05	Edited the X1, X2, and X3 in the mktg outline, then re-released D/S to the WEB.
1.2	01/10/06	Fixed typo, then re-released doc to the WEB.
1.3	01/11/06	Fixed more typo, then re-released doc to the WEB.
1.4	07/06/06	Added the Twu row in the 3.3V and 5.0V EC tables ( per Allan S.), then re-released D/S to the WEB.

## Physical Dimensions inches (millimeters) unless otherwise noted

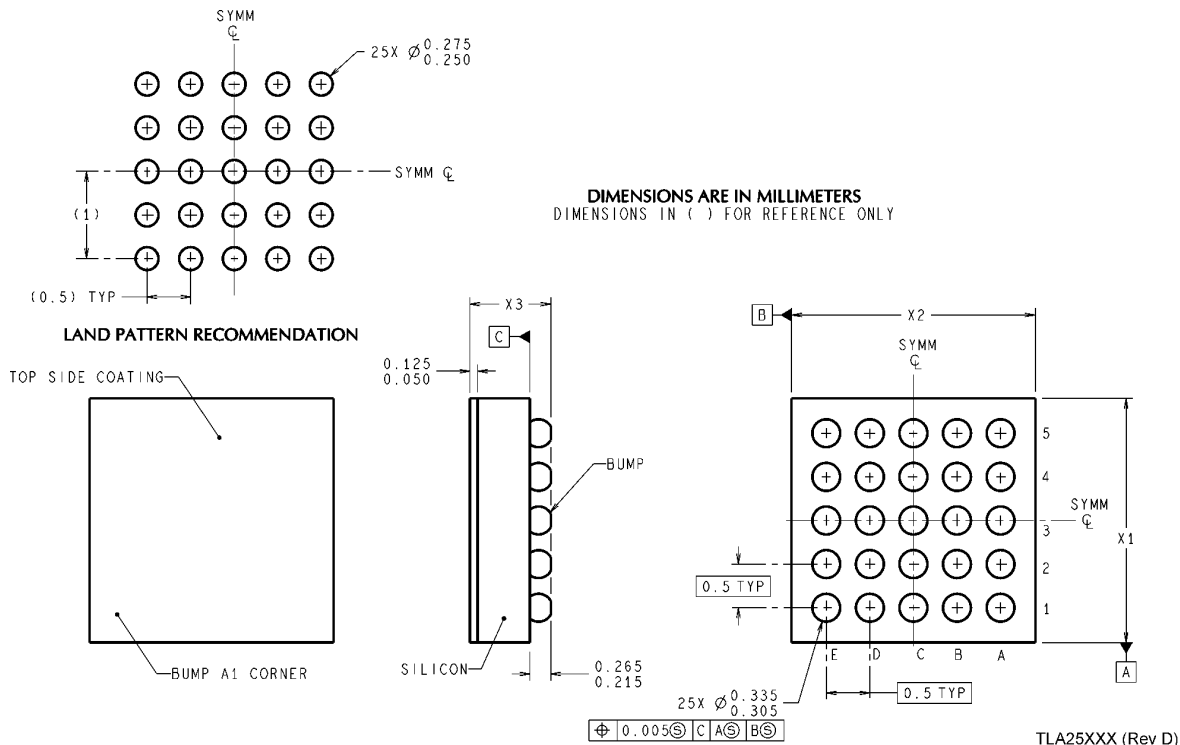

**25 – Bump micro SMD**  
**Order Number LM4845ITL**  
**NS Package Number TLA25CBA**  
**Dimensions are in millimeters**  
 $X_1 = 2.543 \pm 0.03$   $X_2 = 2.517 \pm 0.03$   $X_3 = 0.600 \pm 0.075$

National does not assume any responsibility for use of any circuitry described, no circuit patent licenses are implied and National reserves the right at any time without notice to change said circuitry and specifications.

For the most current product information visit us at [www.national.com](http://www.national.com).

### LIFE SUPPORT POLICY

NATIONAL'S PRODUCTS ARE NOT AUTHORIZED FOR USE AS CRITICAL COMPONENTS IN LIFE SUPPORT DEVICES OR SYSTEMS WITHOUT THE EXPRESS WRITTEN APPROVAL OF THE PRESIDENT AND GENERAL COUNSEL OF NATIONAL SEMICONDUCTOR CORPORATION. As used herein:

1. Life support devices or systems are devices or systems which, (a) are intended for surgical implant into the body, or (b) support or sustain life, and whose failure to perform when properly used in accordance with instructions for use provided in the labeling, can be reasonably expected to result in a significant injury to the user.
2. A critical component is any component of a life support device or system whose failure to perform can be reasonably expected to cause the failure of the life support device or system, or to affect its safety or effectiveness.

### BANNED SUBSTANCE COMPLIANCE

National Semiconductor follows the provisions of the Product Stewardship Guide for Customers (CSP-9-111C2) and Banned Substances and Materials of Interest Specification (CSP-9-111S2) for regulatory environmental compliance. Details may be found at: [www.national.com/quality/green](http://www.national.com/quality/green).

Lead free products are RoHS compliant.



**National Semiconductor**  
**Americas Customer**  
**Support Center**  
 Email: [new.feedback@nsc.com](mailto:new.feedback@nsc.com)  
 Tel: 1-800-272-9959

**National Semiconductor**  
**Europe Customer Support Center**  
 Fax: +49 (0) 180-530 85 86  
 Email: [europe.support@nsc.com](mailto:europe.support@nsc.com)  
 Deutsch Tel: +49 (0) 69 9508 6208  
 English Tel: +44 (0) 870 24 0 2171  
 Français Tel: +33 (0) 1 41 91 8790

**National Semiconductor**  
**Asia Pacific Customer**  
**Support Center**  
 Email: [ap.support@nsc.com](mailto:ap.support@nsc.com)

**National Semiconductor**  
**Japan Customer Support Center**  
 Fax: 81-3-5639-7507  
 Email: [jpn.feedback@nsc.com](mailto:jpn.feedback@nsc.com)  
 Tel: 81-3-5639-7560