

NO. OF CKTS.	DIM. A	DIM. B
1	(2.44 ± .15) .096 ± .006	—
2	(4.98 ± .15) .196 ± .006	(2.54 ± .10) .100 ± .004
3	(7.52 ± .15) .296 ± .006	(5.08 ± .10) .200 ± .004
4	(10.06 ± .15) .396 ± .006	(7.62 ± .10) .300 ± .004
5	(12.60 ± .18) .496 ± .007	(10.16 ± .13) .400 ± .005
6	(15.14 ± .18) .596 ± .007	(12.70 ± .13) .500 ± .005
7	(17.68 ± .20) .696 ± .008	(15.24 ± .15) .600 ± .006
8	(20.22 ± .20) .796 ± .008	(17.78 ± .15) .700 ± .006
9	(22.76 ± .20) .896 ± .008	(20.32 ± .15) .800 ± .006
10	(25.30 ± .25) .996 ± .010	(22.86 ± .20) .900 ± .008
11	(27.84 ± .25) 1.096 ± .010	(25.40 ± .20) 1.000 ± .008
12	(30.38 ± .25) 1.196 ± .010	(27.94 ± .20) 1.100 ± .008
13	(32.92 ± .25) 1.296 ± .010	(30.48 ± .20) 1.200 ± .008
14	(35.46 ± .25) 1.396 ± .010	(33.02 ± .20) 1.300 ± .008
15	(38.00 ± .28) 1.496 ± .011	(35.56 ± .23) 1.400 ± .009
16	(40.54 ± .28) 1.596 ± .011	(38.10 ± .23) 1.500 ± .009
17	(43.08 ± .28) 1.696 ± .011	(40.64 ± .23) 1.600 ± .009
18	(45.62 ± .28) 1.796 ± .011	(43.18 ± .23) 1.700 ± .009
19	(48.16 ± .28) 1.896 ± .011	(45.72 ± .23) 1.800 ± .009
20	(50.70 ± .30) 1.996 ± .012	(48.26 ± .25) 1.900 ± .010

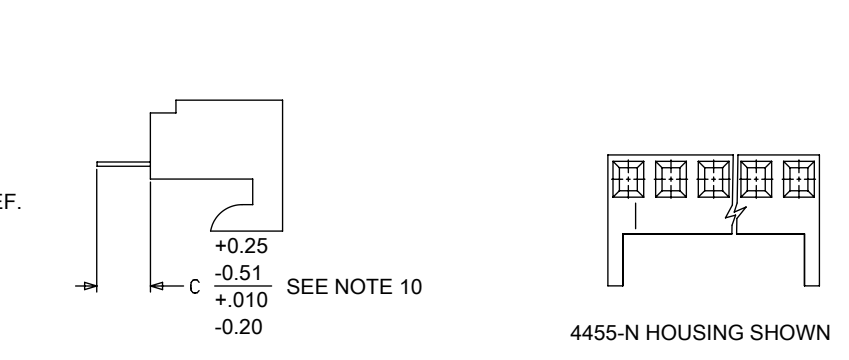
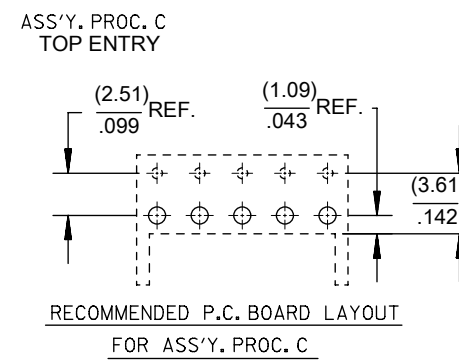
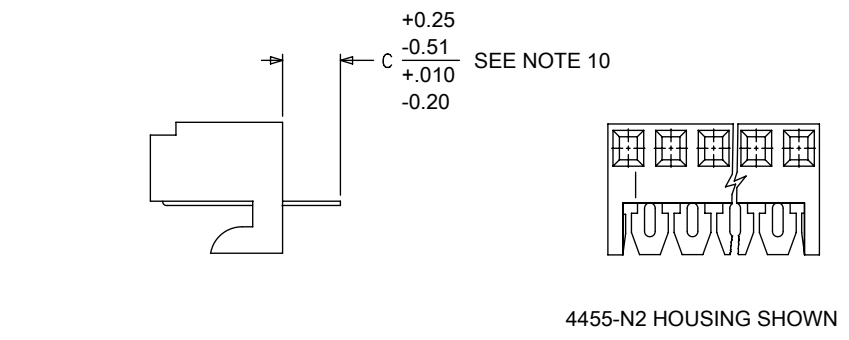
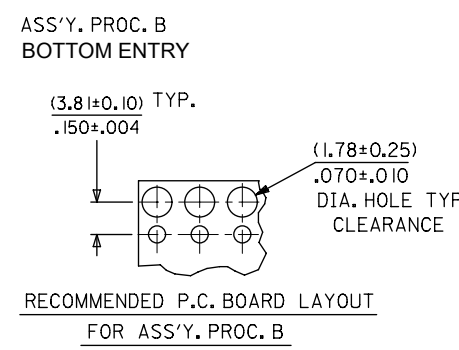
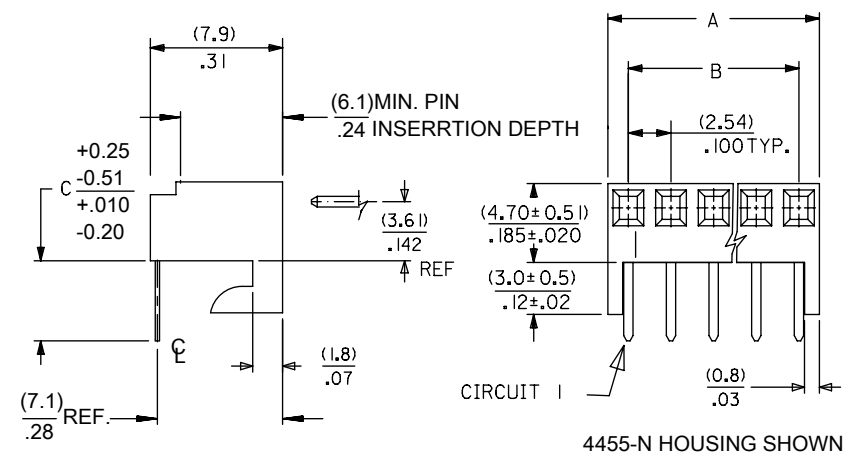
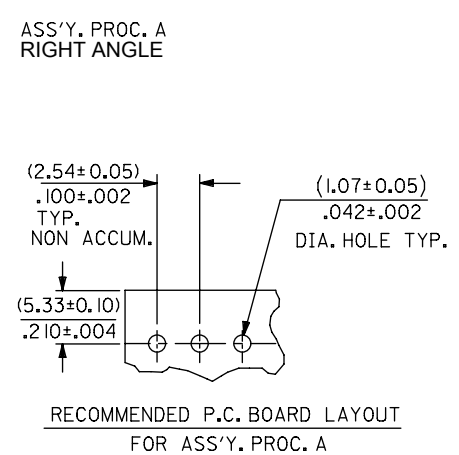

- NOTES:
- MATERIAL: NYLON, UL 94V-0, COLOR: WHITE
  - FINISH:
    - (208) - SELECT GOLD: (0.00038)/.000015 MIN., SELECT TIN: (0.00254)/.000100 MIN. OVERALL NICKEL UNDERPLATE: (0.00127)/.000050 MIN.
    - (228) - SELECT GOLD: (0.00076)/.000030 MIN., SELECT TIN: (0.00254)/.000100 MIN. OVERALL NICKEL UNDERPLATE: (0.00127)/.000050 MIN.
    - (231) - SELECT GOLD: (0.00127)/.000050 MIN., SELECT TIN: (0.00254)/.000100 MIN. OVERALL NICKEL UNDERPLATE: (0.00127)/.000050 MIN.
    - (565) - SELECT GOLD: (0.00051)/.000020 MIN., OVERALL NICKEL: (0.00076)/.000030 MIN. OVERALL GOLD FLASH: (0.00005)/.000002 MIN.
    - (P909) - OVERALL TIN: (0.00254)/.000100 MIN.
  - PARTS CONFORM TO PRODUCT SPECIFICATION PS-10-07.
  - PACKAGING: SEE CHARTS.
  - PARTS MUST CONFORM TO SOLDERABILITY SPEC 152.
  - PARTS ARE STACKABLE END TO END ON (2.54)/.100 CENTERS.
  - TYPICAL PCB THICKNESS: (1.57)/.062
  - PART CONFORMS TO CLASS B REQUIREMENTS OF COSMETIC SPECIFICATION PS-45499-002 EXCEPT PROTRUSIONS. PARTS MAY HAVE MORE THAN 2 GATE MARKS.
  - WHEN MATING ASSEMBLIES THAT USE 4455-BN HOUSINGS TO BREAKAWAY FRICTION LOCK OR POLARIZING HEADERS, THE END BACKWALLS MUST BE REMOVED.
  - DIMENSION C MEASURED WITH TERMINAL PUSHED IN AGAINST THE STOP.

DOCUMENT STATUS	P1	RELEASE DATE	2022/07/29	12:32:02
-----------------	----	--------------	------------	----------

HOUSING NO. 4455-BN SEE NOTE 9		HOUSING NO. 4455-NR	
WITH RAMP AND POLARIZING		WITH RAMP	
HOUSING NO. 4455-N2		HOUSING NO. 4455-N-02	
AVAILABLE ON BOTTOM ENTRY APPLICATIONS ONLY		MOLDED VOID IN CKT 2	
		HOUSING NO. 4455-N	

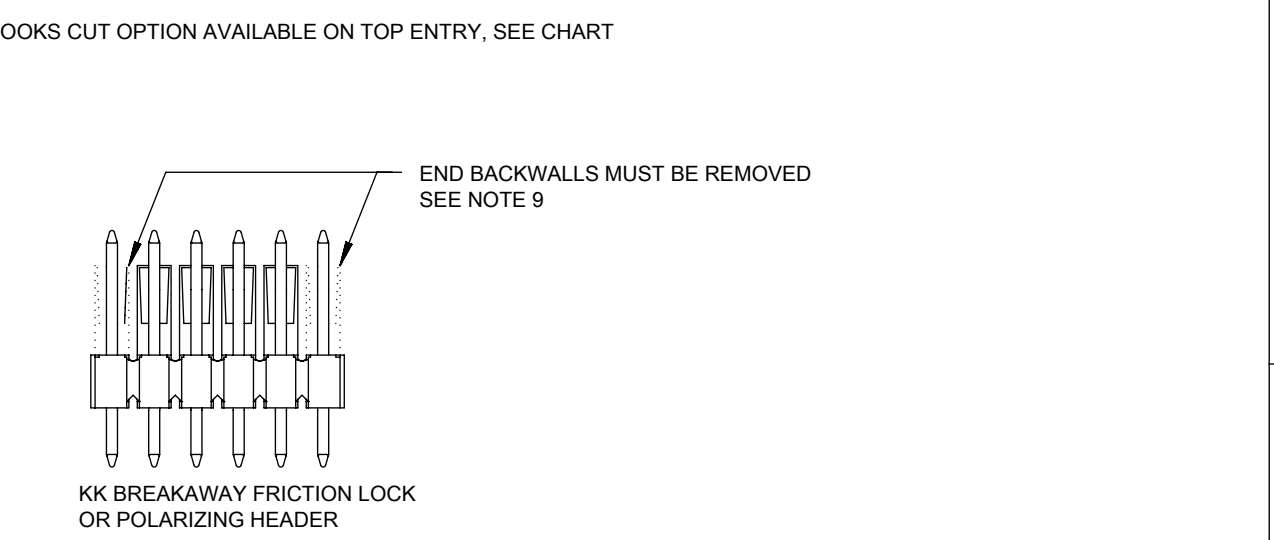
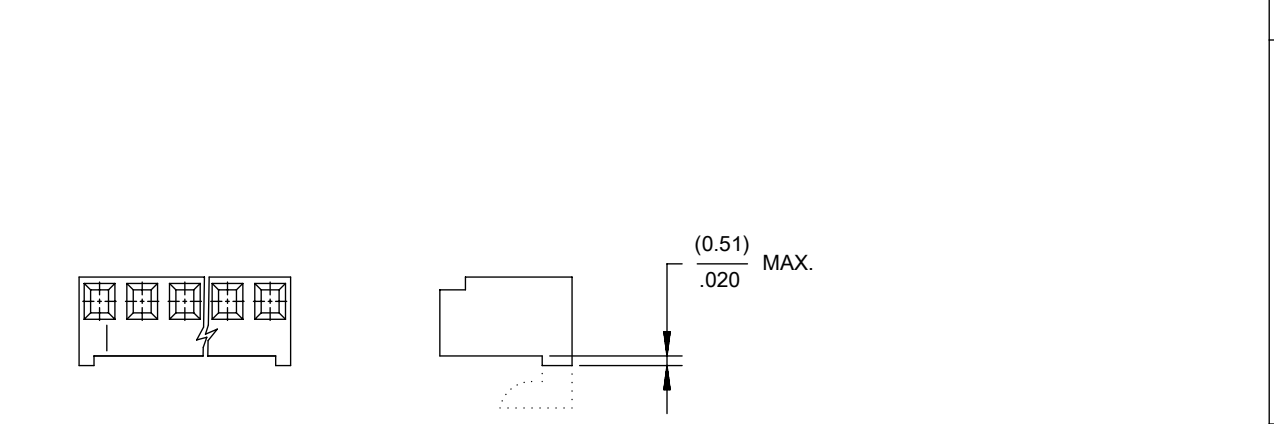

THIS DRAWING CONTAINS INFORMATION THAT IS PROPRIETARY TO MOLEX ELECTRONIC TECHNOLOGIES, LLC AND SHOULD NOT BE USED WITHOUT WRITTEN PERMISSION											
DIMENSION UNITS		SCALE		CURRENT REV DESC: REMOVED OBSOLETE PART NUMBER AS PER PCN#512128.						<b>molex</b>	
MM/IN		1:1									
GENERAL TOLERANCES (UNLESS SPECIFIED)						EC NO: 716046		2022/07/22		PRODUCT CUSTOMER DRAWING	
4 PLACES		±				DRWN: SANTHN		2022/07/29		DOCUMENT NUMBER	
3 PLACES		±		0.01		CHKD: GGA		2022/07/29			
2 PLACES		±		0.25		APPR: GGA		2022/07/29		DOC TYPE	
1 PLACE		±		0.36		INITIAL REVISION:					
0 PLACES		±				DRWN: SAMIEC		1984/05/10		REVISION	
ANGULAR TOL		±		0.5°		APPR: LENZ		1984/05/10			
DRAFT WHERE APPLICABLE MUST REMAIN WITHIN DIMENSIONS				THIRD ANGLE PROJECTION		DRAWING		SERIES		MATERIAL NUMBER	
						B-SIZE		4455		SEE CHART	
						CUSTOMER		GENERAL MARKET		SHEET NUMBER	
										1 OF 15	

# KK 100 PCB ASSY 2-25 CKT 4455 SERIES

A-4455- \* \* N \* \* - \*

**ASSY PROCEDURE**  
 A=RIGHT ANGLE  
 B=BOTTOM ENTRY  
 C=TOP ENTRY

**HOUSING OPTION**

- A=4455-AN
- B=4455-BN
- E=4455-NHH
- G=4455-BN (HOOKS CUT OFF)
- H=4455-N2 (BOTTOM ENTRY ONLY)
- P=4455-NR (HOOKS CUT OFF)
- R=4455-NR
- V=4455-N-02
- W=4455-N-02 (HOOKS CUT OFF)
- Y=4455-N (HOOKS CUT OFF)
- Z=4455-N

**NO OF CIRCUITS**

**TERMINAL TYPE**

Code	Number	Material	Form
A	4316-4	Brass	Standard
B	6516-4	Phos Bronze	Standard
C	6516-5C	Phos Bronze	Cat Ear / V
D	4316-3B	Brass	Std / V
F	6516-6C	Phos Bronze	Cat Ear / V
G	4316-3	Brass	Standard
J	6516-3B	Phos Bronze	Std / V
L	6516-3C	Phos Bronze	Cat Ear / V
M	6516-4A	Phos Bronze	Cat Ear
T	4316-4A	Brass	Cat Ear

**PLATING**

(SEE SHEET 1)

**VOID LOCATION**  
 NUMBER = CIRCUIT VOIDED  
 MULTIPLE VOIDS START  
 WITH 51  
 BLANK = NONE

Ckts	Assy Proc:	RIGHT ANGLE	Assy Proc:	RIGHT ANGLE
		Hooks Cut:	NO	Hooks Cut:
	Housing No:	4455-N	Housing No:	4455-N
	Terminal No:	4316-4(P909)	Terminal No:	4316-4(565)
	Dim C:	3.35 / .132	Dim C:	3.35 / .132
	Plating:	P909	Plating:	565
	Packaging:	PK-44646-001	Packaging:	PK-44646-001
	Voids:	NONE	Voids:	NONE
Material No	Engineer Number	Material No	Engineer Number	
2	22-15-2026	A-4455-AZ02A(P909)	22-16-2021	A-4455-AZ02A(565)
3	22-15-2036	A-4455-AZ03A(P909)	22-16-2031	A-4455-AZ03A(565)
4	22-15-2046	A-4455-AZ04A(P909)	22-16-2041	A-4455-AZ04A(565)
5	22-15-2056	A-4455-AZ05A(P909)	22-16-2051	A-4455-AZ05A(565)
6	22-15-2066	A-4455-AZ06A(P909)	22-16-2061	A-4455-AZ06A(565)
7	22-15-2076	A-4455-AZ07A(P909)	22-16-2071	A-4455-AZ07A(565)
8	22-15-2086	A-4455-AZ08A(P909)	22-16-2081	A-4455-AZ08A(565)
9	22-15-2096	A-4455-AZ09A(P909)	22-16-2091	A-4455-AZ09A(565)
10	22-15-2106	A-4455-AZ10A(P909)	22-16-2101	A-4455-AZ10A(565)
11	22-15-2116	A-4455-AZ11A(P909)	22-16-2111	A-4455-AZ11A(565)
12	22-15-2126	A-4455-AZ12A(P909)	22-16-2121	A-4455-AZ12A(565)
13	22-15-2136	A-4455-AZ13A(P909)	22-16-2131	A-4455-AZ13A(565)
14	22-15-2146	A-4455-AZ14A(P909)	22-16-2141	A-4455-AZ14A(565)
15	22-15-2156	A-4455-AZ15A(P909)	22-16-2151	A-4455-AZ15A(565)
16	22-15-2166	A-4455-AZ16A(P909)	22-16-2161	A-4455-AZ16A(565)
17	22-15-2176	A-4455-AZ17A(P909)	22-16-2171	A-4455-AZ17A(565)
18	22-15-2186	A-4455-AZ18A(P909)	22-16-2181	A-4455-AZ18A(565)
19	22-15-2196	A-4455-AZ19A(P909)	22-16-2191	A-4455-AZ19A(565)
20	22-15-2206	A-4455-AZ20A(P909)	22-16-2201	A-4455-AZ20A(565)
21				
22				
23				
24				
25				

THIS DRAWING CONTAINS INFORMATION THAT IS PROPRIETARY TO MOLEX ELECTRONIC TECHNOLOGIES, LLC AND SHOULD NOT BE USED WITHOUT WRITTEN PERMISSION															
DIMENSION UNITS <b>MM/IN</b>		SCALE <b>1:1</b>		CURRENT REV DESC: REMOVED OBSOLETE PART NUMBER AS PER PCN#512128.				molex							
GENERAL TOLERANCES (UNLESS SPECIFIED)				EC NO: 716046 DRWN: SANTHN 2022/07/22 CHKD: GGA 2022/07/29 APPR: GGA 2022/07/29 INITIAL REVISION: DRWN: SAMIEC 1984/05/10 APPR: LENZ 1984/05/10				PRODUCT CUSTOMER DRAWING							
4 PLACES ±		±						DOCUMENT NUMBER		DOC TYPE		DOC PART		REVISION	
3 PLACES ±		± 0.01						SDA-4455		PSD		001		D18	
2 PLACES ±		± 0.25 ± 0.015													
1 PLACE ±		± 0.36 ±						MATERIAL NUMBER		CUSTOMER		SHEET NUMBER			
0 PLACES ±		±		SEE CHART		GENERAL MARKET		2 OF 15							
ANGULAR TOL ± 0.5°				DRAFT WHERE APPLICABLE MUST REMAIN WITHIN DIMENSIONS		THIRD ANGLE PROJECTION		DRAWING		SERIES					
				B-SIZE		4455									

# KK 100 PCB ASSY 2-25 CKT 4455 SERIES

STANDARD PRODUCT

Ckts	Assy Proc: RIGHT ANGLE		Assy Proc: BOTTOM ENTRY		Assy Proc: BOTTOM ENTRY		Assy Proc: BOTTOM ENTRY	
	Material No	Engineer Number	Material No	Engineer Number	Material No	Engineer Number	Material No	Engineer Number
2	22-16-2020	A-4455-AZ02A(208)	22-14-2024	A-4455-BH02D(P909)	22-17-2022	A-4455-BH02D(565)	22-17-3022	A-4455-BH02D(208)
3	22-16-2030	A-4455-AZ 03 A(208)	22-14-2034	A-4455-BH 03 D(P909)	22-17-2032	A-4455-BH 03 D(565)	22-17-3032	A-4455-BH 03 D(208)
4	22-16-2040	A-4455-AZ 04 A(208)	22-14-2044	A-4455-BH 04 D(P909)	22-17-2042	A-4455-BH 04 D(565)	22-17-3042	A-4455-BH 04 D(208)
5	22-16-2050	A-4455-AZ 05 A(208)	22-14-2054	A-4455-BH 05 D(P909)	22-17-2052	A-4455-BH 05 D(565)	22-17-3052	A-4455-BH 05 D(208)
6	22-16-2060	A-4455-AZ 06 A(208)	22-14-2064	A-4455-BH 06 D(P909)	22-17-2062	A-4455-BH 06 D(565)	22-17-3062	A-4455-BH 06 D(208)
7	22-16-2070	A-4455-AZ 07 A(208)	22-14-2074	A-4455-BH 07 D(P909)	22-17-2072	A-4455-BH 07 D(565)	22-17-3072	A-4455-BH 07 D(208)
8	22-16-2080	A-4455-AZ 08 A(208)	22-14-2084	A-4455-BH 08 D(P909)	22-17-2082	A-4455-BH 08 D(565)	22-17-3082	A-4455-BH 08 D(208)
9	22-16-2090	A-4455-AZ 09 A(208)	22-14-2094	A-4455-BH 09 D(P909)	22-17-2092	A-4455-BH 09 D(565)	22-17-3092	A-4455-BH 09 D(208)
10	22-16-2100	A-4455-AZ 10 A(208)	22-14-2104	A-4455-BH 10 D(P909)	22-17-2102	A-4455-BH 10 D(565)	22-17-3102	A-4455-BH 10 D(208)
11	22-16-2110	A-4455-AZ 11 A(208)	22-14-2114	A-4455-BH 11 D(P909)	22-17-2112	A-4455-BH 11 D(565)	22-17-3112	A-4455-BH 11 D(208)
12	22-16-2120	A-4455-AZ 12 A(208)	22-14-2124	A-4455-BH 12 D(P909)	22-17-2122	A-4455-BH 12 D(565)	22-17-3122	A-4455-BH 12 D(208)
13	22-16-2130	A-4455-AZ 13 A(208)	22-14-2134	A-4455-BH 13 D(P909)	22-17-2132	A-4455-BH 13 D(565)	22-17-3132	A-4455-BH 13 D(208)
14	22-16-2140	A-4455-AZ 14 A(208)	22-14-2144	A-4455-BH 14 D(P909)	22-17-2142	A-4455-BH 14 D(565)	22-17-3142	A-4455-BH 14 D(208)
15	22-16-2150	A-4455-AZ 15 A(208)	22-14-2154	A-4455-BH 15 D(P909)	22-17-2152	A-4455-BH 15 D(565)	22-17-3152	A-4455-BH 15 D(208)
16	22-16-2160	A-4455-AZ 16 A(208)	22-14-2164	A-4455-BH 16 D(P909)	22-17-2162	A-4455-BH 16 D(565)	22-17-3162	A-4455-BH 16 D(208)
17	22-16-2170	A-4455-AZ 17 A(208)	22-14-2174	A-4455-BH 17 D(P909)	22-17-2172	A-4455-BH 17 D(565)	22-17-3172	A-4455-BH 17 D(208)
18	22-16-2180	A-4455-AZ 18 A(208)	22-14-2184	A-4455-BH 18 D(P909)			22-17-3182	A-4455-BH 18 D(208)
19	22-16-2190	A-4455-AZ 19 A(208)	22-14-2194	A-4455-BH 19 D(P909)			22-17-3192	A-4455-BH 19 D(208)
20	22-16-2200	A-4455-AZ 20 A(208)	22-14-2204	A-4455-BH 20 D(P909)	22-17-2202	A-4455-BH 20 D(565)	22-17-3202	A-4455-BH 20 D(208)
21								
22								
23	22-16-2230	A-4455-AZ 23 A(208)						
24								
25								

THIS DRAWING CONTAINS INFORMATION THAT IS PROPRIETARY TO MOLEX ELECTRONIC TECHNOLOGIES, LLC AND SHOULD NOT BE USED WITHOUT WRITTEN PERMISSION												
DIMENSION UNITS	SCALE	CURRENT REV DESC: REMOVED OBSOLETE PART NUMBER AS PER PCN#512128.					molex					
MM/IN	1:1						KK 100 PCB ASSY 4455 SERIES DWG					
GENERAL TOLERANCES (UNLESS SPECIFIED)		EC NO: 716046 DRWN: SANTHN 2022/07/22 CHKD: GGA 2022/07/29 APPR: GGA 2022/07/29 INITIAL REVISION: DRWN: SAMIEC 1984/05/10 APPR: LENZ 1984/05/10					PRODUCT CUSTOMER DRAWING					
							DOCUMENT NUMBER    DOC TYPE    DOC PART    REVISION					
4 PLACES	±						SDA-4455					
3 PLACES	±						PSD    001    D18					
2 PLACES	± 0.25						MATERIAL NUMBER    CUSTOMER    SHEET NUMBER					
1 PLACE	± 0.36	SEE CHART    GENERAL MARKET    3 OF 15										
0 PLACES	±	DRAFT WHERE APPLICABLE MUST REMAIN WITHIN DIMENSIONS    THIRD ANGLE PROJECTION    DRAWING    SERIES    B-SIZE    4455										

# KK 100 PCB ASSY 2-25 CKT 4455 SERIES

Ckts	Assy Proc: TOP ENTRY		Assy Proc: TOP ENTRY		Assy Proc: TOP ENTRY		Assy Proc: RIGHT ANGLE	
	Material No	Engineer Number	Material No	Engineer Number	Material No	Engineer Number	Material No	Engineer Number
2	22-02-2025	A-4455-CZ02A(P909)	22-18-2023	A-4455-CZ02A(565)	22-18-2021	A-4455-CZ02A(208)	22-15-4025	A-4455-AZ02B(P909)
3	22-02-2035	A-4455-CZ 03A(P909)	22-18-2033	A-4455-CZ 03 A(565)	22-18-2031	A-4455-CZ 03 A(208)	22-15-4035	A-4455-AZ 03B(P909)
4	22-02-2045	A-4455-CZ 04A(P909)	22-18-2043	A-4455-CZ 04 A(565)	22-18-2041	A-4455-CZ 04 A(208)	22-15-4045	A-4455-AZ 04B(P909)
5	22-02-2055	A-4455-CZ 05A(P909)	22-18-2053	A-4455-CZ 05 A(565)	22-18-2051	A-4455-CZ 05 A(208)	22-15-4055	A-4455-AZ 05B(P909)
6	22-02-2065	A-4455-CZ 06A(P909)	22-18-2063	A-4455-CZ 06 A(565)	22-18-2061	A-4455-CZ 06 A(208)	22-15-4065	A-4455-AZ 06B(P909)
7	22-02-2075	A-4455-CZ 07A(P909)	22-18-2073	A-4455-CZ 07 A(565)	22-18-2071	A-4455-CZ 07 A(208)	22-15-4075	A-4455-AZ 07B(P909)
8	22-02-2085	A-4455-CZ 08 A(P909)	22-18-2083	A-4455-CZ 08 A(565)	22-18-2081	A-4455-CZ 08 A(208)	22-15-4085	A-4455-AZ 08B(P909)
9	22-02-2095	A-4455-CZ 09 A(P909)	22-18-2093	A-4455-CZ 09 A(565)	22-18-2091	A-4455-CZ 09 A(208)	22-15-4095	A-4455-AZ 09B(P909)
10	22-02-2105	A-4455-CZ 10 A(P909)	22-18-2103	A-4455-CZ 10 A(565)	22-18-2101	A-4455-CZ 10 A(208)	22-15-4105	A-4455-AZ 10B(P909)
11	22-02-2115	A-4455-CZ 11 A(P909)	22-18-2113	A-4455-CZ 11 A(565)	22-18-2111	A-4455-CZ 11 A(208)	22-15-4115	A-4455-AZ 11B(P909)
12	22-02-2125	A-4455-CZ 12 A(P909)	22-18-2123	A-4455-CZ 12 A(565)	22-18-2121	A-4455-CZ 12 A(208)	22-15-4125	A-4455-AZ 12B(P909)
13	22-02-2135	A-4455-CZ 13 A(P909)	22-18-2133	A-4455-CZ 13 A(565)	22-18-2131	A-4455-CZ 13 A(208)	22-15-4135	A-4455-AZ 13B(P909)
14	22-02-2145	A-4455-CZ 14 A(P909)	22-18-2143	A-4455-CZ 14 A(565)	22-18-2141	A-4455-CZ 14 A(208)	22-15-4145	A-4455-AZ 14B(P909)
15	22-02-2155	A-4455-CZ 15 A(P909)			22-18-2151	A-4455-CZ 15 A(208)	22-15-4155	A-4455-AZ 15B(P909)
16	22-02-2165	A-4455-CZ 16 A(P909)			22-18-2161	A-4455-CZ 16 A(208)	22-15-4165	A-4455-AZ 16B(P909)
17	22-02-2175	A-4455-CZ 17 A(P909)			22-18-2171	A-4455-CZ 17 A(208)	22-15-4175	A-4455-AZ 17B(P909)
18	22-02-2185	A-4455-CZ 18 A(P909)	22-18-2183	A-4455-CZ 18 A(565)	22-18-2181	A-4455-CZ 18 A(208)	22-15-4185	A-4455-AZ 18B(P909)
19	22-02-2195	A-4455-CZ 19 A(P909)			22-18-2191	A-4455-CZ 19 A(208)	22-15-4195	A-4455-AZ 19B(P909)
20	22-02-2205	A-4455-CZ 20 A(P909)	22-18-2203	A-4455-CZ 20 A(565)	22-18-2201	A-4455-CZ 20 A(208)	22-15-4205	A-4455-AZ 20B(P909)
21							22-15-4215	A-4455-AZ 21B(P909)
22							22-15-4225	A-4455-AZ 22B(P909)
23							22-15-4235	A-4455-AZ 23B(P909)
24							22-15-4245	A-4455-AZ 24B(P909)
25							22-15-4255	A-4455-AZ 25B(P909)

THIS DRAWING CONTAINS INFORMATION THAT IS PROPRIETARY TO MOLEX ELECTRONIC TECHNOLOGIES, LLC AND SHOULD NOT BE USED WITHOUT WRITTEN PERMISSION												
DIMENSION UNITS <b>MM/IN</b>		SCALE <b>1:1</b>		CURRENT REV DESC: REMOVED OBSOLETE PART NUMBER AS PER PCN#512128.				molex				
GENERAL TOLERANCES (UNLESS SPECIFIED)						EC NO: 716046		KK 100 PCB ASSY 4455 SERIES DWG				
4 PLACES ± 0.25 ± 0.015						DRWN: SANTHN 2022/07/22						
3 PLACES ± 0.25 ± 0.015						CHKD: GGA 2022/07/29		PRODUCT CUSTOMER DRAWING				
2 PLACES ± 0.25 ± 0.015						APPR: GGA 2022/07/29		DOCUMENT NUMBER				
1 PLACE ± 0.36 ± 0.015						INITIAL REVISION:		SDA-4455		DOC TYPE	DOC PART	REVISION
0 PLACES ± 0.36 ± 0.015						DRWN: SAMIEC 1984/05/10		PSD		001	D18	
ANGULAR TOL ± 0.5°						APPR: LENZ 1984/05/10		SHEET NUMBER				
DRAFT WHERE APPLICABLE MUST REMAIN WITHIN DIMENSIONS						THIRD ANGLE PROJECTION		DRAWING	SERIES	MATERIAL NUMBER	CUSTOMER	
								B-SIZE	4455	SEE CHART	GENERAL MARKET	4 OF 15

# KK 100 PCB ASSY 2-25 CKT

## 4455 SERIES

Ckts	Assy Proc: RIGHT ANGLE		Assy Proc: RIGHT ANGLE		Assy Proc: BOTTOM ENTRY		Assy Proc: BOTTOM ENTRY	
		Hooks Cut:	NO	Hooks Cut:	NO	Hooks Cut:	NO	Hooks Cut:
	Housing No:	4455-N	Housing No:	4455-N	Housing No:	4455-N2	Housing No:	4455-N2
	Terminal No:	6516-4(565)	Terminal No:	6516-4(208)	Terminal No:	6516-3B(565)	Terminal No:	6516-3B(208)
	Dim C:	3.35 / .132	Dim C:	3.35 / .132	Dim C:	3.35 / .132	Dim C:	3.35 / .132
	Plating:	565	Plating:	208	Plating:	565	Plating:	208
	Packaging:	PK-44646-001	Packaging:	PK-44646-001	Packaging:	PK-44646-001	Packaging:	PK-44646-001
	Voids:	NONE	Voids:	NONE	Voids:	NONE	Voids:	NONE
	Material No	Engineer Number	Material No	Engineer Number	Material No	Engineer Number	Material No	Engineer Number
2	22-16-2024	A-4455-AZ02B(565)			22-17-2021	A-4455-BH02J(565)		
3	22-16-2034	A-4455-AZ 03 B(565)			22-17-2031	A-4455-BH 03 J(565)		
4	22-16-2044	A-4455-AZ 04 B(565)			22-17-2041	A-4455-BH 04 J(565)		
5	22-16-2054	A-4455-AZ 05 B(565)			22-17-2051	A-4455-BH 05 J(565)		
6	22-16-2064	A-4455-AZ 06 B(565)			22-17-2061	A-4455-BH 06 J(565)		
7	22-16-2074	A-4455-AZ 07 B(565)			22-17-2071	A-4455-BH 07 J(565)		
8	22-16-2084	A-4455-AZ 08 B(565)			22-17-2081	A-4455-BH 08 J(565)		
9	22-16-2094	A-4455-AZ 09 B(565)			22-17-2091	A-4455-BH 09 J(565)		
10	22-16-2104	A-4455-AZ 10 B(565)			22-17-2101	A-4455-BH 10 J(565)		
11	22-16-2114	A-4455-AZ 11 B(565)			22-17-2111	A-4455-BH 11 J(565)		
12	22-16-2124	A-4455-AZ 12 B(565)			22-17-2121	A-4455-BH 12 J(565)		
13	22-16-2134	A-4455-AZ 13 B(565)			22-17-2131	A-4455-BH 13 J(565)		
14	22-16-2144	A-4455-AZ 14 B(565)			22-17-2141	A-4455-BH 14 J(565)		
15	22-16-2154	A-4455-AZ 15 B(565)			22-17-2151	A-4455-BH 15 J(565)		
16	22-16-2164	A-4455-AZ 16 B(565)			22-17-2161	A-4455-BH 16 J(565)		
17	22-16-2174	A-4455-AZ 17 B(565)			22-17-2171	A-4455-BH 17 J(565)		
18	22-16-2184	A-4455-AZ 18 B(565)			22-17-2181	A-4455-BH 18 J(565)		
19	22-16-2194	A-4455-AZ 19 B(565)			22-17-2191	A-4455-BH 19 J(565)		
20	22-16-2204	A-4455-AZ 20 B(565)			22-17-2201	A-4455-BH 20 J(565)		
21	22-16-2214	A-4455-AZ 21 B(565)			22-17-2211	A-4455-BH 21 J(565)		
22	22-16-2224	A-4455-AZ 22 B(565)			22-17-2221	A-4455-BH 22 J(565)		
23	22-16-2234	A-4455-AZ 23 B(565)			22-17-2231	A-4455-BH 23 J(565)		
24	22-16-2244	A-4455-AZ 24 B(565)			22-17-2241	A-4455-BH 24 J(565)		
25					22-17-2251	A-4455-BH 25 J(565)		

THIS DRAWING CONTAINS INFORMATION THAT IS PROPRIETARY TO MOLEX ELECTRONIC TECHNOLOGIES, LLC AND SHOULD NOT BE USED WITHOUT WRITTEN PERMISSION											
DIMENSION UNITS		SCALE		CURRENT REV DESC: REMOVED OBSOLETE PART NUMBER AS PER PCN#512128.				molex			
MM/IN		1:1									
GENERAL TOLERANCES (UNLESS SPECIFIED)				EC NO: 716046 DRWN: SANTHN 2022/07/22 CHKD: GGA 2022/07/29 APPR: GGA 2022/07/29				PRODUCT CUSTOMER DRAWING			
4 PLACES ±		±									
3 PLACES ±		± 0.01									
2 PLACES ±		± 0.25 ± 0.015									
1 PLACE ±		± 0.36 ±									
0 PLACES ±		±		INITIAL REVISION:				DOCUMENT NUMBER			
ANGULAR TOL ±		± 0.5°		DRWN: SAMIEC 1984/05/10				SDA-4455			
DRAFT WHERE APPLICABLE MUST REMAIN WITHIN DIMENSIONS		THIRD ANGLE PROJECTION		DRAWING		SERIES		MATERIAL NUMBER		CUSTOMER	
				B-SIZE		4455		SEE CHART		GENERAL MARKET	
								DOC TYPE		DOC PART	
								PSD		001	
								REVISION		D18	
								SHEET NUMBER		5 OF 15	

# KK 100 PCB ASSY 2-25 CKT 4455 SERIES

Ckts	Assy Proc: TOP ENTRY		Assy Proc: TOP ENTRY		Assy Proc: TOP ENTRY		Assy Proc: RIGHT ANGLE	
	Material No	Engineer Number	Material No	Engineer Number	Material No	Engineer Number	Material No	Engineer Number
2			22-18-2022	A-4455-CZ02B(565)				
3			22-18-2032	A-4455-CZ 03 B(565)				
4			22-18-2042	A-4455-CZ 04 B(565)				
5			22-18-2052	A-4455-CZ 05 B(565)				
6			22-18-2062	A-4455-CZ 06 B(565)				
7			22-18-2072	A-4455-CZ 07 B(565)			22-15-2075	A-4455-AA07A(P909)
8			22-18-2082	A-4455-CZ 08 B(565)			22-15-2085	A-4455-AA 08A(P909)
9			22-18-2092	A-4455-CZ 09 B(565)			22-15-2095	A-4455-AA 09A(P909)
10			22-18-2102	A-4455-CZ 10 B(565)			22-15-2105	A-4455-AA 10A(P909)
11			22-18-2112	A-4455-CZ 11 B(565)			22-15-2115	A-4455-AA 11A(P909)
12			22-18-2122	A-4455-CZ 12 B(565)				
13			22-18-2132	A-4455-CZ 13 B(565)			22-15-2135	A-4455-AA 13A(P909)
14			22-18-2142	A-4455-CZ 14 B(565)			22-15-2145	A-4455-AA 14A(P909)
15			22-18-2152	A-4455-CZ 15 B(565)			22-15-2155	A-4455-AA 15A(P909)
16			22-18-2162	A-4455-CZ 16 B(565)			22-15-2165	A-4455-AA 16A(P909)
17			22-18-2172	A-4455-CZ 17 B(565)			22-15-2175	A-4455-AA 17A(P909)
18			22-18-2182	A-4455-CZ 18 B(565)				
19			22-18-2192	A-4455-CZ 19 B(565)			22-15-2195	A-4455-AA 19A(P909)
20			22-18-2202	A-4455-CZ 20 B(565)				
21			22-18-2212	A-4455-CZ 21 B(565)			22-15-2215	A-4455-AA 21A(P909)
22			22-18-2222	A-4455-CZ 22 B(565)			22-15-2225	A-4455-AA 22A(P909)
23			22-18-2232	A-4455-CZ 23 B(565)				
24			22-18-2242	A-4455-CZ 24 B(565)			22-15-2245	A-4455-AA 24A(P909)
25			22-18-2252	A-4455-CZ 25 B(565)			22-15-2255	A-4455-AA 25A(P909)

THIS DRAWING CONTAINS INFORMATION THAT IS PROPRIETARY TO MOLEX ELECTRONIC TECHNOLOGIES, LLC AND SHOULD NOT BE USED WITHOUT WRITTEN PERMISSION											
DIMENSION UNITS <b>MM/IN</b>		SCALE <b>1:1</b>		CURRENT REV DESC: REMOVED OBSOLETE PART NUMBER AS PER PCN#512128.				molex			
GENERAL TOLERANCES (UNLESS SPECIFIED)						EC NO: 716046		KK 100 PCB ASSY 4455 SERIES DWG			
4 PLACES ±		MM		INCH		DRWN: SANTHN 2022/07/22					
3 PLACES ±		0.25		0.015		CHKD: GGA 2022/07/29					
2 PLACES ±		0.36		±		APPR: GGA 2022/07/29					
1 PLACE ±		0.5°		±		INITIAL REVISION:		DOCUMENT NUMBER		DOC TYPE   DOC PART   REVISION	
0 PLACES ±		±		±		DRWN: SAMIEC 1984/05/10		SDA-4455		PSD   001   D18	
ANGULAR TOL ±		0.5°		±		APPR: LENZ 1984/05/10		MATERIAL NUMBER		CUSTOMER	
DRAFT WHERE APPLICABLE MUST REMAIN WITHIN DIMENSIONS				THIRD ANGLE PROJECTION		DRAWING		SERIES		SHEET NUMBER	
						B-SIZE		4455		SEE CHART   GENERAL MARKET   6 OF 15	

# KK 100 PCB ASSY 2-25 CKT 4455 SERIES

Ckts	Assy Proc: RIGHT ANGLE		Assy Proc: RIGHT ANGLE		Assy Proc: RIGHT ANGLE		Assy Proc: RIGHT ANGLE	
	Material No	Engineer Number	Material No	Engineer Number	Material No	Engineer Number	Material No	Engineer Number
2					22-15-4024	A-4455-AB02A(P909)		
3					22-15-4034	A-4455-AB 03A(P909)		
4					22-15-4044	A-4455-AB 04A(P909)		
5					22-15-4054	A-4455-AB 05A(P909)		
6			50-34-8518	A-4455-AB 06 A(228)	22-15-4064	A-4455-AB 06A(P909)		
7					22-15-4074	A-4455-AB 07A(P909)		
8					22-15-4084	A-4455-AB 08A(P909)		
9	22-16-2096	A-4455-AA 09 A(208)			22-15-4094	A-4455-AB 09A(P909)		
10							22-15-2102	A-4455-AE 10A(P909)
11					22-15-4114	A-4455-AB 11A(P909)		
12					22-15-4124	A-4455-AB 12A(P909)		
13					22-15-4134	A-4455-AB 13A(P909)		
14					22-15-4144	A-4455-AB 14A(P909)		
15					22-15-4154	A-4455-AB 15A(P909)		
16					22-15-4164	A-4455-AB 16A(P909)		
17					22-15-4174	A-4455-AB 17A(P909)		
18	22-16-2186	A-4455-AA 18 A(208)						
19	22-16-2196	A-4455-AA 19 A(208)			22-15-4194	A-4455-AB 19A(P909)		
20	22-16-2206	A-4455-AA 20 A(208)			22-15-4204	A-4455-AB 20A(P909)		
21	22-16-2216	A-4455-AA 21 A(208)			22-15-4214	A-4455-AB 21A(P909)		
22	22-16-2226	A-4455-AA 22 A(208)			22-15-4224	A-4455-AB 22A(P909)		
23	22-16-2236	A-4455-AA 23 A(208)			22-15-4234	A-4455-AB 23A(P909)		
24					22-15-4244	A-4455-AB 24A(P909)		
25					22-15-4254	A-4455-AB 25A(P909)	22-15-2252	A-4455-AE 25A(P909)

THIS DRAWING CONTAINS INFORMATION THAT IS PROPRIETARY TO MOLEX ELECTRONIC TECHNOLOGIES, LLC AND SHOULD NOT BE USED WITHOUT WRITTEN PERMISSION														
DIMENSION UNITS <b>MM/IN</b>		SCALE <b>1:1</b>		CURRENT REV DESC: REMOVED OBSOLETE PART NUMBER AS PER PCN#512128.				molex						
GENERAL TOLERANCES (UNLESS SPECIFIED)				EC NO: 716046 DRWN: SANTHN 2022/07/22 CHKD: GGA 2022/07/29 APPR: GGA 2022/07/29				KK 100 PCB ASSY 4455 SERIES DWG						
4 PLACES ±		±						PRODUCT CUSTOMER DRAWING						
3 PLACES ±		± 0.01						DOCUMENT NUMBER				DOC TYPE	DOC PART	REVISION
2 PLACES ±		0.25 ± 0.015						SDA-4455				PSD	001	D18
1 PLACE ±		0.36 ±						INITIAL REVISION: DRWN: SAMIEC 1984/05/10 APPR: LENZ 1984/05/10				SHEET NUMBER		
0 PLACES ±		±		DRAFT WHERE APPLICABLE MUST REMAIN WITHIN DIMENSIONS				THIRD ANGLE PROJECTION		DRAWING	SERIES	MATERIAL NUMBER	CUSTOMER	
ANGULAR TOL ±		0.5°				B-SIZE	4455	SEE CHART	GENERAL MARKET		7 OF 15			

# KK 100 PCB ASSY 2-25 CKT 4455 SERIES

Ckts	Assy Proc: RIGHT ANGLE		Assy Proc: RIGHT ANGLE		Assy Proc: RIGHT ANGLE		Assy Proc: RIGHT ANGLE	
	Material No	Engineer Number	Material No	Engineer Number	Material No	Engineer Number	Material No	Engineer Number
2	22-15-4022	A-4455-AR02A(P909)			22-17-5023	A-4455-AZ02B(228)		
3	22-15-4032	A-4455-AR 03 A(P909)			22-17-5033	A-4455-AZ 03 B(228)		
4	22-15-4042	A-4455-AR 04 A(P909)			22-17-5043	A-4455-AZ 04 B(228)		
5	22-15-4052	A-4455-AR 05 A(P909)						
6	22-15-4062	A-4455-AR 06 A(P909)			22-17-5063	A-4455-AZ 06 B(228)		
7	22-15-4072	A-4455-AR 07 A(P909)			22-17-5073	A-4455-AZ 07 B(228)		
8	22-15-4082	A-4455-AR 08 A(P909)			22-17-5083	A-4455-AZ 08 B(228)		
9	22-15-4092	A-4455-AR 09 A(P909)			22-17-5093	A-4455-AZ 09 B(228)		
10	22-15-4102	A-4455-AR 10 A(P909)			22-17-5103	A-4455-AZ 10 B(228)		
11	22-15-4112	A-4455-AR 11 A(P909)			22-17-5113	A-4455-AZ 11 B(228)		
12	22-15-4122	A-4455-AR 12 A(P909)			22-17-5123	A-4455-AZ 12 B(228)		
13	22-15-4132	A-4455-AR 13 A(P909)			22-17-5133	A-4455-AZ 13 B(228)		
14	22-15-4142	A-4455-AR 14 A(P909)			22-17-5143	A-4455-AZ 14 B(228)		
15	22-15-4152	A-4455-AR 15 A(P909)			22-17-5153	A-4455-AZ 15 B(228)		
16	22-15-4162	A-4455-AR 16 A(P909)			22-17-5163	A-4455-AZ 16 B(228)		
17	22-15-4172	A-4455-AR 17 A(P909)			22-17-5173	A-4455-AZ 17 B(228)		
18	22-15-4182	A-4455-AR 18 A(P909)			22-17-5183	A-4455-AZ 18 B(228)		
19	22-15-4192	A-4455-AR 19 A(P909)			22-17-5193	A-4455-AZ 19 B(228)		
20	22-15-4202	A-4455-AR 20 A(P909)	22-17-5201	A-4455-AZ 20 A(228)	22-17-5203	A-4455-AZ 20 B(228)		
21	22-15-4212	A-4455-AR 21 A(P909)			22-17-5213	A-4455-AZ 21 B(228)		
22	22-15-4222	A-4455-AR 22 A(P909)			22-17-5223	A-4455-AZ 22 B(228)		
23	22-15-4232	A-4455-AR 23 A(P909)			22-17-5233	A-4455-AZ 23 B(228)		
24	22-15-4242	A-4455-AR 24 A(P909)			22-17-5243	A-4455-AZ 24 B(228)		
25	22-15-4252	A-4455-AR 25 A(P909)			22-17-5253	A-4455-AZ 25 B(228)		

THIS DRAWING CONTAINS INFORMATION THAT IS PROPRIETARY TO MOLEX ELECTRONIC TECHNOLOGIES, LLC AND SHOULD NOT BE USED WITHOUT WRITTEN PERMISSION											
DIMENSION UNITS <b>MM/IN</b>		SCALE <b>1:1</b>		CURRENT REV DESC: REMOVED OBSOLETE PART NUMBER AS PER PCN#512128.				molex			
GENERAL TOLERANCES (UNLESS SPECIFIED)						EC NO: 716046		DRWN: SANTHN		2022/07/22	
4 PLACES ±		MM		INCH		CHKD: GGA		2022/07/29		2022/07/29	
3 PLACES ±		0.25		0.015		APPR: GGA		2022/07/29		PRODUCT CUSTOMER DRAWING	
2 PLACES ±		0.36		±		INITIAL REVISION:		DRWN: SAMIEC		1984/05/10	
1 PLACE ±		0.5		°		APPR: LENZ		1984/05/10		DOCUMENT NUMBER	
ANGULAR TOL ±		0.5		°		THIRD ANGLE PROJECTION		DRAWING		SERIES	
DRAFT WHERE APPLICABLE MUST REMAIN WITHIN DIMENSIONS		B-SIZE		4455		MATERIAL NUMBER		CUSTOMER		SHEET NUMBER	
SEE CHART		GENERAL MARKET		8 OF 15		SDA-4455		PSD		001 D18	



# KK 100 PCB ASSY 2-25 CKT

## 4455 SERIES

Ckts	Assy Proc: BOTTOM ENTRY		Assy Proc: BOTTOM ENTRY		Assy Proc: BOTTOM ENTRY		Assy Proc: BOTTOM ENTRY	
	Material No	Engineer Number	Material No	Engineer Number	Material No	Engineer Number	Material No	Engineer Number
2	22-17-2024	A-4455-BH02D(228)					22-17-2027	A-4455-BH02J(228)
3	22-17-2034	A-4455-BH03D(228)					22-17-2037	A-4455-BH03J(228)
4	22-17-2044	A-4455-BH04D(228)					22-17-2047	A-4455-BH04J(228)
5	22-17-2054	A-4455-BH05D(228)			22-17-3056	A-4455-BH05D(228)	22-17-2057	A-4455-BH05J(228)
6	22-17-2064	A-4455-BH06D(228)			22-17-3066	A-4455-BH06D(228)	22-17-2067	A-4455-BH06J(228)
7	22-17-2074	A-4455-BH07D(228)					22-17-2077	A-4455-BH07J(228)
8	22-17-2084	A-4455-BH08D(228)			22-17-3086	A-4455-BH08D(228)	22-17-2087	A-4455-BH08J(228)
9	22-17-2094	A-4455-BH09D(228)					22-17-2097	A-4455-BH09J(228)
10	22-17-2104	A-4455-BH10D(228)					22-17-2107	A-4455-BH10J(228)
11	22-17-2114	A-4455-BH11D(228)					22-17-2117	A-4455-BH11J(228)
12	22-17-2124	A-4455-BH12D(228)					22-17-2127	A-4455-BH12J(228)
13	22-17-2134	A-4455-BH13D(228)					22-17-2137	A-4455-BH13J(228)
14	22-17-2144	A-4455-BH14D(228)	22-17-2140	A-4455-BH 14 D(231)	22-17-3146	A-4455-BH14D(228)	22-17-2147	A-4455-BH14J(228)
15							22-17-2157	A-4455-BH15J(228)
16	22-17-2164	A-4455-BH16D(228)					22-17-2167	A-4455-BH16J(228)
17							22-17-2177	A-4455-BH17J(228)
18	22-17-2184	A-4455-BH18D(228)					22-17-2187	A-4455-BH18J(228)
19	22-17-2194	A-4455-BH19D(228)			22-17-3196	A-4455-BH19D(228)	22-17-2197	A-4455-BH19J(228)
20	22-17-2204	A-4455-BH20D(228)	22-17-2200	A-4455-BH 20 D(231)	22-17-3206	A-4455-BH20D(228)	22-17-2207	A-4455-BH20J(228)
21	22-17-2214	A-4455-BH21D(228)						
22	22-17-2224	A-4455-BH22D(228)						
23	22-17-2234	A-4455-BH23D(228)						
24	22-17-2244	A-4455-BH24D(228)						
25	22-17-2254	A-4455-BH25D(228)	22-17-2250	A-4455-BH 25 D(231)	22-17-3256	A-4455-BH25D(228)		

THIS DRAWING CONTAINS INFORMATION THAT IS PROPRIETARY TO MOLEX ELECTRONIC TECHNOLOGIES, LLC AND SHOULD NOT BE USED WITHOUT WRITTEN PERMISSION									
DIMENSION UNITS <b>MM/IN</b>		SCALE <b>1:1</b>		CURRENT REV DESC: REMOVED OBSOLETE PART NUMBER AS PER PCN#512128.				molex	
GENERAL TOLERANCES (UNLESS SPECIFIED)				EC NO: 716046		2022/07/22		PRODUCT CUSTOMER DRAWING	
4 PLACES ±		MM		DRWN: SANTHN		2022/07/29			
3 PLACES ±		INCH		CHKD: GGA		2022/07/29		DOCUMENT NUMBER	
2 PLACES ± 0.25		± 0.015		APPR: GGA		2022/07/29		DOC TYPE DOC PART REVISION	
1 PLACE ± 0.36		±		INITIAL REVISION:		1984/05/10		<b>SDA-4455</b>	
0 PLACES ±		±		DRWN: SAMIEC		1984/05/10		PSD 001 D18	
ANGULAR TOL ± 0.5°		±		APPR: LENZ		1984/05/10		SHEET NUMBER	
DRAFT WHERE APPLICABLE MUST REMAIN WITHIN DIMENSIONS				THIRD ANGLE PROJECTION		DRAWING		SERIES	
				B-SIZE		4455		MATERIAL NUMBER CUSTOMER	
				SEE CHART		GENERAL MARKET		9 OF 15	

# KK 100 PCB ASSY 2-25 CKT 4455 SERIES

Ckts	Assy Proc: TOP ENTRY		Assy Proc: TOP ENTRY		Assy Proc: TOP ENTRY		Assy Proc: TOP ENTRY	
		Hooks Cut:	YES	Hooks Cut:	YES	Hooks Cut:	YES	Hooks Cut:
	Housing No:	4455-NR	Housing No:	4455-N	Housing No:	4455-N	Housing No:	4455-BN
	Terminal No:	4316-4(208)	Terminal No:	4316-4(565)	Terminal No:	4316-4(P909)	Terminal No:	4316-4(P909)
	Dim C:	3.35 / .132	Dim C:	3.35 / .132	Dim C:	3.35 / .132	Dim C:	3.35 / .132
	Plating:	208	Plating:	565	Plating:	P909	Plating:	P909
	Packaging:	PK-44646-003	Packaging:	PK-44646-003	Packaging:	PK-44646-003	Packaging:	PK-44646-002
	Voids:	NO	Voids:	NO	Voids:	NO	Voids:	NO
	Material No	Engineer Number	Material No	Engineer Number	Material No	Engineer Number	Material No	Engineer Number
2			22-18-2026	A-4455-CY02A(565)	22-02-7023	A-4455-CY02A(P909)	22-15-4028	A-4455-CB02A(P909)
3			22-18-2036	A-4455-CY 03 A(565)	22-02-7033	A-4455-CY 03A(P909)	22-15-4038	A-4455-CB 03A(P909)
4			22-18-2046	A-4455-CY 04 A(565)	22-02-7043	A-4455-CY 04A(P909)	22-15-4048	A-4455-CB 04A(P909)
5	22-18-2057	A-4455-CP 05 A(208)			22-02-7053	A-4455-CY 05A(P909)	22-15-4058	A-4455-CB 05A(P909)
6			22-18-2066	A-4455-CY 06 A(565)	22-02-7063	A-4455-CY 06A(P909)	22-15-4068	A-4455-CB 06A(P909)
7					22-02-7073	A-4455-CY 07A(P909)	22-15-4078	A-4455-CB 07A(P909)
8					22-02-7083	A-4455-CY 08A(P909)	22-15-4088	A-4455-CB 08A(P909)
9					22-02-7093	A-4455-CY 09A(P909)	22-15-4098	A-4455-CB 09A(P909)
10					22-02-7103	A-4455-CY 10A(P909)	22-15-4108	A-4455-CB 10A(P909)
11					22-02-7113	A-4455-CY 11A(P909)	22-15-4118	A-4455-CB 11A(P909)
12			22-18-2126	A-4455-CY 12 A(565)	22-02-7123	A-4455-CY 12A(P909)	22-15-4128	A-4455-CB 12A(P909)
13					22-02-7133	A-4455-CY 13A(P909)	22-15-4138	A-4455-CB 13A(P909)
14			22-18-2146	A-4455-CY 14 A(565)	22-02-7143	A-4455-CY 14A(P909)	22-15-4148	A-4455-CB 14A(P909)
15			22-18-2156	A-4455-CY 15 A(565)	22-02-7153	A-4455-CY 15A(P909)	22-15-4158	A-4455-CB 15A(P909)
16			22-18-2166	A-4455-CY 16 A(565)	22-02-7163	A-4455-CY 16A(P909)	22-15-4168	A-4455-CB 16A(P909)
17			22-18-2176	A-4455-CY 17 A(565)	22-02-7173	A-4455-CY 17A(P909)	22-15-4178	A-4455-CB 17A(P909)
18			22-18-2186	A-4455-CY 18 A(565)	22-02-7183	A-4455-CY 18A(P909)		
19			22-18-2196	A-4455-CY 19 A(565)	22-02-7193	A-4455-CY 19A(P909)	22-15-4198	A-4455-CB 19A(P909)
20			22-18-2206	A-4455-CY 20 A(565)	22-02-7203	A-4455-CY 20A(P909)	22-15-4208	A-4455-CB 20A(P909)
21			22-18-2216	A-4455-CY 21 A(565)	22-02-7213	A-4455-CY 21A(P909)	22-15-4218	A-4455-CB 21A(P909)
22			22-18-2226	A-4455-CY 22 A(565)	22-02-7223	A-4455-CY 22A(P909)	22-15-4228	A-4455-CB 22A(P909)
23			22-18-2236	A-4455-CY 23 A(565)	22-02-7233	A-4455-CY 23A(P909)	22-15-4238	A-4455-CB 23A(P909)
24			22-18-2246	A-4455-CY 24 A(565)			22-15-4248	A-4455-CB 24A(P909)
25			22-18-2256	A-4455-CY 25 A(565)			22-15-4258	A-4455-CB 25A(P909)

THIS DRAWING CONTAINS INFORMATION THAT IS PROPRIETARY TO MOLEX ELECTRONIC TECHNOLOGIES, LLC AND SHOULD NOT BE USED WITHOUT WRITTEN PERMISSION											
DIMENSION UNITS	SCALE	CURRENT REV DESC: REMOVED OBSOLETE PART NUMBER AS PER PCN#512128.			molex						
MM/IN	1:1				KK 100 PCB ASSY 4455 SERIES DWG						
GENERAL TOLERANCES (UNLESS SPECIFIED)					PRODUCT CUSTOMER DRAWING						
	MM	INCH									
4 PLACES	±		±								
3 PLACES	±		±	0.01							
2 PLACES	±	0.25	±	0.015							
1 PLACE	±	0.36	±								
0 PLACES	±		±								
ANGULAR TOL		± 0.5°									
DRAFT WHERE APPLICABLE MUST REMAIN WITHIN DIMENSIONS		THIRD ANGLE PROJECTION		DRAWING	SERIES	MATERIAL NUMBER	CUSTOMER	DOCUMENT NUMBER	DOC TYPE	DOC PART	REVISION
				B-SIZE	4455	SEE CHART	GENERAL MARKET	SDA-4455	PSD	001	D18

# KK 100 PCB ASSY 2-25 CKT 4455 SERIES

Ckts	Assy Proc: TOP ENTRY		Assy Proc: TOP ENTRY		Assy Proc: TOP ENTRY		Assy Proc: TOP ENTRY	
	Material No	Engineer Number	Material No	Engineer Number	Material No	Engineer Number	Material No	Engineer Number
2	22-65-3020	A-4455-CR02A(P909)			22-18-7023	A-4455-CY02A(208)	22-18-7021	A-4455-CY02B(228)
3	22-65-3030	A-4455-CR 03A(P909)			22-18-7033	A-4455-CY 03 A(208)	22-18-7031 38-00-1478	A-4455-CY 03 B(228)
4	22-65-3040	A-4455-CR 04A(P909)			22-18-7043	A-4455-CY 04 A(208)	22-18-7041	A-4455-CY 04 B(228)
5	22-65-3050	A-4455-CR 05A(P909)			22-18-7053	A-4455-CY 05 A(208)	22-18-7051	A-4455-CY 05 B(228)
6	22-65-3060	A-4455-CR 06A(P909)			22-18-7063	A-4455-CY 06 A(208)	22-18-7061	A-4455-CY 06 B(228)
7	22-65-3070	A-4455-CR 07A(P909)			22-18-7073	A-4455-CY 07 A(208)	22-18-7071	A-4455-CY 07 B(228)
8	22-65-3080	A-4455-CR 08A(P909)			22-18-7083	A-4455-CY 08 A(208)	22-18-7081	A-4455-CY 08 B(228)
9	22-65-3090	A-4455-CR 09A(P909)			22-18-7093	A-4455-CY 09 A(208)	22-18-7091	A-4455-CY 09 B(228)
10	22-65-3100	A-4455-CR 10A(P909)			22-18-7103	A-4455-CY 10 A(208)	22-18-7101	A-4455-CY 10 B(228)
11	22-65-3110	A-4455-CR 11A(P909)			22-18-7113	A-4455-CY 11 A(208)	22-18-7111	A-4455-CY 11 B(228)
12	22-65-3120	A-4455-CR 12A(P909)	22-18-2124	A-4455-CZ 12 B(228)	22-18-7123	A-4455-CY 12 A(208)	22-18-7121	A-4455-CY 12 B(228)
13	22-65-3130	A-4455-CR 13A(P909)			22-18-7133	A-4455-CY 13 A(208)	22-18-7131	A-4455-CY 13 B(228)
14	22-65-3140	A-4455-CR 14A(P909)			22-18-7143	A-4455-CY 14 A(208)	22-18-7141	A-4455-CY 14 B(228)
15	22-65-3150	A-4455-CR 15A(P909)			22-18-7153	A-4455-CY 15 A(208)	22-18-7151	A-4455-CY 15 B(228)
16	22-65-3160	A-4455-CR 16A(P909)	22-18-2164	A-4455-CZ 16 B(228)	22-18-7163	A-4455-CY 16 A(208)	22-18-7161	A-4455-CY 16 B(228)
17	22-65-3170	A-4455-CR 17A(P909)			22-18-7173	A-4455-CY 17 A(208)	22-18-7171	A-4455-CY 17 B(228)
18	22-65-3180	A-4455-CR 18A(P909)			22-18-7183	A-4455-CY 18 A(208)	22-18-7181	A-4455-CY 18 B(228)
19	22-65-3190	A-4455-CR 19A(P909)	22-18-2194	A-4455-CZ 19 B(228)	22-18-7193	A-4455-CY 19 A(208)	22-18-7191	A-4455-CY 19 B(228)
20	22-65-3200	A-4455-CR 20A(P909)			22-18-7203	A-4455-CY 20 A(208)	22-18-7201	A-4455-CY 20 B(228)
21	22-65-3210	A-4455-CR 21A(P909)			22-18-7213	A-4455-CY 21 A(208)	22-18-7211	A-4455-CY 21 B(228)
22	22-65-3220	A-4455-CR 22A(P909)			22-18-7223	A-4455-CY 22 A(208)	22-18-7221	A-4455-CY 22 B(228)
23	22-65-3230	A-4455-CR 23A(P909)			22-18-7233	A-4455-CY 23 A(208)	22-18-7231	A-4455-CY 23 B(228)
24	22-65-3240	A-4455-CR 24A(P909)			22-18-7243	A-4455-CY 24 A(208)		
25	22-65-3250	A-4455-CR 25A(P909)			22-18-7253	A-4455-CY 25 A(208)	22-18-7251	A-4455-CY 25 B(228)

THIS DRAWING CONTAINS INFORMATION THAT IS PROPRIETARY TO MOLEX ELECTRONIC TECHNOLOGIES, LLC AND SHOULD NOT BE USED WITHOUT WRITTEN PERMISSION									
DIMENSION UNITS <b>MM/IN</b>	SCALE <b>1:1</b>	CURRENT REV DESC: REMOVED OBSOLETE PART NUMBER AS PER PCN#512128.			molex				
GENERAL TOLERANCES (UNLESS SPECIFIED)		EC NO: 716046			KK 100 PCB ASSY 4455 SERIES DWG				
4 PLACES ± 0.25 ± 0.015		DRWN: SANTHN 2022/07/22							
3 PLACES ± 0.25 ± 0.015		CHKD: GGA 2022/07/29			PRODUCT CUSTOMER DRAWING				
2 PLACES ± 0.25 ± 0.015		APPR: GGA 2022/07/29			DOCUMENT NUMBER    DOC TYPE    DOC PART    REVISION				
1 PLACE ± 0.36 ± 0.015		INITIAL REVISION:			<b>SDA-4455</b> PSD    001    D18				
0 PLACES ± 0.36 ± 0.015		DRWN: SAMIEC 1984/05/10			MATERIAL NUMBER    CUSTOMER    SHEET NUMBER				
ANGULAR TOL ± 0.5°		APPR: LENZ 1984/05/10			SEE CHART    GENERAL MARKET    11 OF 15				
DRAFT WHERE APPLICABLE MUST REMAIN WITHIN DIMENSIONS		THIRD ANGLE PROJECTION			DRAWING    SERIES    MATERIAL NUMBER    CUSTOMER    SHEET NUMBER				
					<b>B-SIZE</b> 4455    SEE CHART    GENERAL MARKET    11 OF 15				

# KK 100 PCB ASSY 2-25 CKT 4455 SERIES

Ckts	Assy Proc: RIGHT ANGLE		Assy Proc: BOTTOM ENTRY		Assy Proc: RIGHT ANGLE		Assy Proc: RIGHT ANGLE	
	Material No	Engineer Number	Material No	Engineer Number	Material No	Engineer Number	Material No	Engineer Number
2	38-00-1332	A-4455-AZ02C(P909)	38-00-1392	A-4455-BH02F(P909)			22-14-2079	A-4455-AA07B(P909)
3	38-00-1333	A-4455-AZ03C(P909)	38-00-1393	A-4455-BH03F(P909)			22-14-2089	A-4455-AA 08 B(P909)
4	38-00-1334	A-4455-AZ04C(P909)	38-00-1394	A-4455-BH04F(P909)			22-14-2099	A-4455-AA 09 B(P909)
5	38-00-1335	A-4455-AZ05C(P909)	38-00-1395	A-4455-BH05F(P909)			22-14-2109	A-4455-AA 10 B(P909)
6	38-00-1336	A-4455-AZ06C(P909)	38-00-1396	A-4455-BH06F(P909)			22-14-2119	A-4455-AA 11 B(P909)
7	38-00-1337	A-4455-AZ07C(P909)	38-00-1397	A-4455-BH07F(P909)			22-14-2129	A-4455-AA 12 B(P909)
8	38-00-1338	A-4455-AZ08C(P909)	38-00-1398	A-4455-BH08F(P909)			22-14-2139	A-4455-AA 13 B(P909)
9	38-00-1339	A-4455-AZ09C(P909)	38-00-1399	A-4455-BH09F(P909)			22-14-2149	A-4455-AA 14 B(P909)
10	38-00-1340	A-4455-AZ10C(P909)	38-00-1400	A-4455-BH10F(P909)			22-14-2159	A-4455-AA 15 B(P909)
11	38-00-1341	A-4455-AZ11C(P909)	38-00-1401	A-4455-BH11F(P909)			22-14-2169	A-4455-AA 16 B(P909)
12	38-00-1342	A-4455-AZ12C(P909)	38-00-1402	A-4455-BH12F(P909)			22-14-2179	A-4455-AA 17 B(P909)
13	38-00-1343	A-4455-AZ13C(P909)	38-00-1403	A-4455-BH13F(P909)			22-14-2189	A-4455-AA 18 B(P909)
14	38-00-1344	A-4455-AZ14C(P909)	38-00-1404	A-4455-BH14F(P909)			22-14-2199	A-4455-AA 19 B(P909)
15	38-00-1345	A-4455-AZ15C(P909)	38-00-1405	A-4455-BH15F(P909)			22-14-2209	A-4455-AA 20 B(P909)
16	38-00-1346	A-4455-AZ16C(P909)	38-00-1406	A-4455-BH16F(P909)			22-14-2219	A-4455-AA 21 B(P909)
17	38-00-1347	A-4455-AZ17C(P909)	38-00-1407	A-4455-BH17F(P909)			22-14-2229	A-4455-AA 22 B(P909)
18	38-00-1348	A-4455-AZ18C(P909)	38-00-1408	A-4455-BH18F(P909)			22-14-2239	A-4455-AA 23 B(P909)
19	38-00-1349	A-4455-AZ19C(P909)	38-00-1409	A-4455-BH19F(P909)			22-14-2249	A-4455-AA 24 B(P909)
20	38-00-1350	A-4455-AZ20C(P909)	38-00-1410	A-4455-BH20F(P909)			22-14-2259	A-4455-AA 25 B(P909)
21								
22								
23								
24								
25								

THIS DRAWING CONTAINS INFORMATION THAT IS PROPRIETARY TO MOLEX ELECTRONIC TECHNOLOGIES, LLC AND SHOULD NOT BE USED WITHOUT WRITTEN PERMISSION												
DIMENSION UNITS <b>MM/IN</b>		SCALE <b>1:1</b>		CURRENT REV DESC: REMOVED OBSOLETE PART NUMBER AS PER PCN#512128.				molex				
GENERAL TOLERANCES (UNLESS SPECIFIED)						EC NO: 716046		KK 100 PCB ASSY 4455 SERIES DWG				
4 PLACES ± 0.25 ± 0.015						DRWN: SANTHN 2022/07/22						
3 PLACES ± 0.25 ± 0.015						CHKD: GGA 2022/07/29		PRODUCT CUSTOMER DRAWING				
2 PLACES ± 0.25 ± 0.015						APPR: GGA 2022/07/29		DOCUMENT NUMBER				
1 PLACE ± 0.36 ± 0.015						INITIAL REVISION:		SDA-4455		DOC TYPE	DOC PART	REVISION
0 PLACES ± 0.36 ± 0.015						DRWN: SAMIEC 1984/05/10		PSD		001	D18	
ANGULAR TOL ± 0.5°						APPR: LENZ 1984/05/10		12 OF 15				
DRAFT WHERE APPLICABLE MUST REMAIN WITHIN DIMENSIONS						THIRD ANGLE PROJECTION		DRAWING	SERIES	MATERIAL NUMBER	CUSTOMER	SHEET NUMBER
								B-SIZE	4455	SEE CHART	GENERAL MARKET	12 OF 15

# KK 100 PCB ASSY 2-25 CKT

## 4455 SERIES

Ckts	Assy Proc: RIGHT ANGLE		Assy Proc: RIGHT ANGLE		Assy Proc: TOP ENTRY		Assy Proc: TOP ENTRY	
	Material No	Engineer Number	Material No	Engineer Number	Material No	Engineer Number	Material No	Engineer Number
2			22-16-3028	A-4455-AB02A(565)	38-00-1422	A-4455-CZ02C(P909)		
3			22-16-3038	A-4455-AB 03 A(565)	38-00-1423	A-4455-CZ03C(P909)		
4			22-16-3048	A-4455-AB 04 A(565)	38-00-1424	A-4455-CZ04C(P909)		
5			22-16-3058	A-4455-AB 05 A(565)	38-00-1425	A-4455-CZ05C(P909)		
6			22-16-3068	A-4455-AB 06 A(565)	38-00-1426	A-4455-CZ06C(P909)	22-02-3068	A-4455-CW06A(P909)-2
7	22-14-3617	A-4455-AA07T(P909)	22-16-3078	A-4455-AB 07 A(565)	38-00-1427	A-4455-CZ07C(P909)	50-29-0004	A-4455-CW07A(P909)-2
8	22-14-3618	A-4455-AA 08 T(P909)	22-16-3088	A-4455-AB 08 A(565)	38-00-1428	A-4455-CZ08C(P909)		
9	22-14-3619	A-4455-AA 09 T(P909)	22-16-3098	A-4455-AB 09 A(565)	38-00-1429	A-4455-CZ09C(P909)		
10	22-14-3711	A-4455-AA 10 T(P909)	22-16-3108	A-4455-AB 10 A(565)	38-00-1430	A-4455-CZ10C(P909)		
11	22-14-3712	A-4455-AA 11 T(P909)	22-16-3118	A-4455-AB 11 A(565)	38-00-1431	A-4455-CZ11C(P909)		
12	22-14-3713	A-4455-AA 12 T(P909)	22-16-3128	A-4455-AB 12 A(565)	38-00-1432	A-4455-CZ12C(P909)		
13	22-14-3714	A-4455-AA 13 T(P909)	22-16-3138	A-4455-AB 13 A(565)	38-00-1433	A-4455-CZ13C(P909)		
14	22-14-3715	A-4455-AA 14 T(P909)	22-16-3148	A-4455-AB 14 A(565)	38-00-1434	A-4455-CZ14C(P909)		
15	22-14-3716	A-4455-AA 15 T(P909)	22-16-3158	A-4455-AB 15 A(565)	38-00-1435	A-4455-CZ15C(P909)		
16	22-14-3717	A-4455-AA 16 T(P909)	22-16-3168	A-4455-AB 16 A(565)	38-00-1436	A-4455-CZ16C(P909)		
17	22-14-3718	A-4455-AA 17 T(P909)	22-16-3178	A-4455-AB 17 A(565)	38-00-1437	A-4455-CZ17C(P909)		
18	22-14-3719	A-4455-AA 18 T(P909)	22-16-3188	A-4455-AB 18 A(565)	38-00-1438	A-4455-CZ18C(P909)		
19	22-14-3811	A-4455-AA 19 T(P909)	22-16-3198	A-4455-AB 19 A(565)	38-00-1439	A-4455-CZ19C(P909)		
20	22-14-3812	A-4455-AA 20 T(P909)	22-16-3208	A-4455-AB 20 A(565)	38-00-1440	A-4455-CZ20C(P909)		
21	22-14-3813	A-4455-AA 21 T(P909)	22-16-3218	A-4455-AB 21 A(565)				
22	22-14-3814	A-4455-AA 22 T(P909)	22-16-3228	A-4455-AB 22 A(565)				
23	22-14-3815	A-4455-AA 23 T(P909)	22-16-3238	A-4455-AB 23 A(565)				
24	22-14-3816	A-4455-AA 24 T(P909)	22-16-3248	A-4455-AB 24 A(565)				
25			22-16-3258	A-4455-AB 25 A(565)				

THIS DRAWING CONTAINS INFORMATION THAT IS PROPRIETARY TO MOLEX ELECTRONIC TECHNOLOGIES, LLC AND SHOULD NOT BE USED WITHOUT WRITTEN PERMISSION												
DIMENSION UNITS	SCALE	CURRENT REV DESC: REMOVED OBSOLETE PART NUMBER AS PER PCN#512128.					molex					
MM/IN	1:1						KK 100 PCB ASSY 4455 SERIES DWG					
GENERAL TOLERANCES (UNLESS SPECIFIED)		EC NO: 716046 DRWN: SANTHN 2022/07/22 CHKD: GGA 2022/07/29 APPR: GGA 2022/07/29					PRODUCT CUSTOMER DRAWING					
							INITIAL REVISION:					
4 PLACES	±						DRWN: SAMIEC 1984/05/10					
3 PLACES	±						APPR: LENZ 1984/05/10					
2 PLACES	±						THIRD ANGLE PROJECTION					
1 PLACE	±	DRAWING										
0 PLACES	±	SERIES										
ANGULAR TOL ± 0.5°		MATERIAL NUMBER										
DRAFT WHERE APPLICABLE MUST REMAIN WITHIN DIMENSIONS		CUSTOMER										
		SHEET NUMBER										
		SEE CHART										
		GENERAL MARKET										
		13 OF 15										

# KK 100 PCB ASSY 2-25 CKT 4455 SERIES

Ckts	Assy Proc: TOP ENTRY		Assy Proc: TOP ENTRY		Assy Proc: BOTTOM ENTRY		Assy Proc: BOTTOM ENTRY	
	Material No	Engineer Number	Material No	Engineer Number	Material No	Engineer Number	Material No	Engineer Number
2								
3								
4								
5	50-29-1553	A-4455-CY 05B(P909)						
6	50-29-1554	A-4455-CY 06B(P909)	22-15-5065	A-4455-CY06A(P909)-2				
7								
8								
9								
10								
11					50-36-1881	A-4455-BH11D(P909)-10		
12								
13							26-01-3099	A-4455-BH13D(208)-51
14								
15								
16								
17								
18								
19								
20								
21								
22								
23								
24								
25								

THIS DRAWING CONTAINS INFORMATION THAT IS PROPRIETARY TO MOLEX ELECTRONIC TECHNOLOGIES, LLC AND SHOULD NOT BE USED WITHOUT WRITTEN PERMISSION										
DIMENSION UNITS <b>MM/IN</b>	SCALE <b>1:1</b>	CURRENT REV DESC: REMOVED OBSOLETE PART NUMBER AS PER PCN#512128.			molex					
GENERAL TOLERANCES (UNLESS SPECIFIED)		EC NO: 716046			KK 100 PCB ASSY 4455 SERIES DWG					
4 PLACES ±	±	DRWN: SANTHN 2022/07/22			PRODUCT CUSTOMER DRAWING					
3 PLACES ±	± 0.01	CHKD: GGA 2022/07/29			DOCUMENT NUMBER					
2 PLACES ± 0.25	± 0.015	APPR: GGA 2022/07/29			SDA-4455			DOC TYPE	DOC PART	REVISION
1 PLACE ± 0.36	±	INITIAL REVISION:			PSD			001	D18	
0 PLACES ±	±	DRWN: SAMIEC 1984/05/10			MATERIAL NUMBER					
ANGULAR TOL ± 0.5°	±	APPR: LENZ 1984/05/10			SEE CHART			CUSTOMER		
DRAFT WHERE APPLICABLE MUST REMAIN WITHIN DIMENSIONS		THIRD ANGLE PROJECTION	DRAWING	SERIES	GENERAL MARKET		SHEET NUMBER			
			B-SIZE	4455			14 OF 15			

# KK 100 PCB ASSY 2-25 CKT 4455 SERIES

Ckts	Material No	Engineer Number	Material No	Engineer Number	Material No	Engineer Number	Material No	Engineer Number
2								
3			46999-0585	A-4455-CG03A(P909)			22-02-2031	A-4455-CY 03A(P909)
4			46999-0583	A-4455-CG04A(P909)				
5								
6			46999-0584	A-4455-CG06A(P909)				
7								
8					46999-0599	A-4455-CP 08A(P909)		
9								
10								
11								
12								
13								
14			46999-0586	A-4455-CG14A(P909)				
15								
16								
17	46999-0582	A-4455-AB17A(P909)-51						
18								
19								
20								
21								
22								
23								
24								
25								

THIS DRAWING CONTAINS INFORMATION THAT IS PROPRIETARY TO MOLEX ELECTRONIC TECHNOLOGIES, LLC AND SHOULD NOT BE USED WITHOUT WRITTEN PERMISSION												
DIMENSION UNITS	SCALE	CURRENT REV DESC: REMOVED OBSOLETE PART NUMBER AS PER PCN#512128.									molex	
MM/IN	1:1											
GENERAL TOLERANCES (UNLESS SPECIFIED)		EC NO: 716046 DRWN: SANTHN CHKD: GGA APPR: GGA INITIAL REVISION: DRWN: SAMIEC APPR: LENZ									KK 100 PCB ASSY 4455 SERIES DWG	
4 PLACES ±	±											
3 PLACES ±	± 0.01											
2 PLACES ±	± 0.25 ± 0.015											
1 PLACE ±	± 0.36 ±											
0 PLACES ±	±	2022/07/22 2022/07/29 2022/07/29 1984/05/10 1984/05/10									PRODUCT CUSTOMER DRAWING	
ANGULAR TOL ± 0.5°		THIRD ANGLE PROJECTION		DRAWING		SERIES		MATERIAL NUMBER		CUSTOMER		
DRAFT WHERE APPLICABLE MUST REMAIN WITHIN DIMENSIONS				B-SIZE		4455		SEE CHART		GENERAL MARKET		
DOCUMENT STATUS		P1		RELEASE DATE		2022/07/29		12:32:02		REVISION		
										DOCUMENT NUMBER SDA-4455		
										DOC TYPE DOC PART REVISION PSD 001 D18		
										SHEET NUMBER 15 OF 15		