

OPA3S328 40-MHz, Dual, Precision, Low-Noise, Low-Input-Bias-Current CMOS Operational Amplifier With Integrated Switches

1 Features

- Precision operational amplifier with integrated switches for transimpedance applications
- Wide bandwidth: 40 MHz
- Low offset voltage: 60 μV (max)
- Very low offset drift: 1 $\mu\text{V}/^\circ\text{C}$ (max)
- Low input bias current: 0.2 pA
- Rail-to-rail input and output
- Zero-crossover input stage
- Low voltage noise: 6.1 $\text{nV}/\sqrt{\text{Hz}}$ at 10 kHz
- Low current noise: 0.125 $\text{pA}/\sqrt{\text{Hz}}$ at 10 kHz
- Low leakage switches: 10 pA
- Slew rate: 30 $\text{V}/\mu\text{s}$
- Quiescent current: 3.8 mA per channel
- Current in shutdown mode: 30 μA
- Output impedance in shutdown mode: 100 $\text{G}\Omega$
- Single-supply voltage range: 2.2 V to 5.5 V
- Unity-gain stable
- Small packages:
 - 20-lead, 3.5-mm x 3.5-mm VQFN
 - 2.0-mm x 2.0-mm DSBGA

2 Applications

- [Optical transport inter-dc interconnect](#)
- [Optical module](#)
- [Optical network terminal unit \(ONT\)](#)
- [Small cell base station](#)
- [Digital multimeter \(DMM\)](#)
- [Data acquisition \(DAQ\)](#)

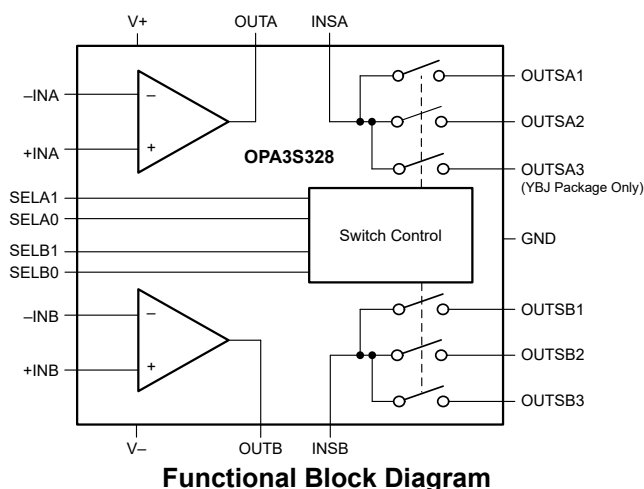

3 Description

The OPA3S328 is a precision, low-voltage, CMOS operational amplifier (op amp) with integrated switches that are optimized for flexible transimpedance applications. Low input bias current and low input capacitance allows for high-frequency transimpedance gains at low photocurrent operation ($< 1 \text{ nA}$). The integrated switches, low offset, and rail-to-rail output performance of the OPA3S328 enable high accuracy across multiple decades of current values. Small packages, along with integrated switches, allow for selectable transimpedance gains and help reduce size for space-constrained applications.

The OPA3S328 features zero-crossover input technology, giving the flexibility for the input common-mode range to span the full supply range without offset deviations. The device provides enable-disable capability to allow for portable, handheld applications in test and measurement. When disabled, the OPA3S328 output impedance is typically 100 $\text{G}\Omega$, allowing for wired-OR applications using multiple transimpedance channels.

Device Information

PART NUMBER	PACKAGE ⁽¹⁾	BODY SIZE (NOM)
OPA3S328	VQFN (20)	3.50 mm × 3.50 mm
	DSBGA (24) ⁽²⁾	2.00 mm × 2.00 mm

- (1) For all available packages, see the package option addendum at the end of the data sheet.
- (2) DSBGA package is preview.

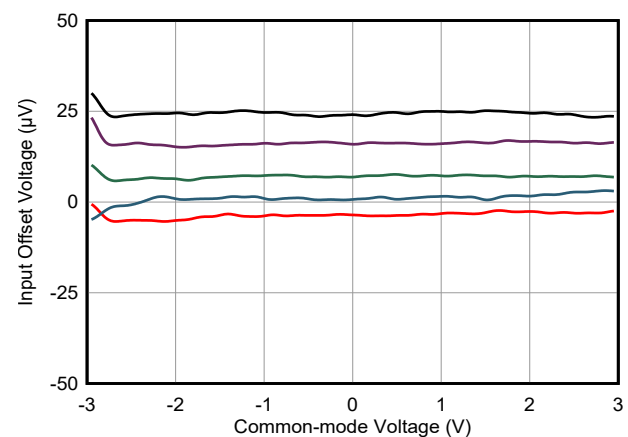

Table of Contents

1 Features	1	8.4 Device Functional Modes.....	20
2 Applications	1	9 Application and Implementation	21
3 Description	1	9.1 Application Information.....	21
4 Revision History	2	9.2 Typical Application.....	24
5 Pin Configuration and Functions	3	10 Power Supply Recommendations	25
6 Specifications	5	11 Layout	26
6.1 Absolute Maximum Ratings.....	5	11.1 Layout Guidelines.....	26
6.2 ESD Ratings.....	5	11.2 Layout Example.....	26
6.3 Recommended Operating Conditions.....	5	12 Device and Documentation Support	27
6.4 Thermal Information.....	5	12.1 Device Support.....	27
6.5 Electrical Characteristics.....	6	12.2 Documentation Support.....	28
6.6 Timing Diagram.....	8	12.3 Receiving Notification of Documentation Updates.....	28
6.7 Typical Characteristics.....	9	12.4 Support Resources.....	28
7 Parameter Measurement Information	17	12.5 Trademarks.....	28
7.1 Switch Characterization Configurations.....	17	12.6 Electrostatic Discharge Caution.....	28
8 Detailed Description	18	12.7 Glossary.....	28
8.1 Overview.....	18	13 Mechanical, Packaging, and Orderable Information	28
8.2 Functional Block Diagram.....	18		
8.3 Feature Description.....	18		

4 Revision History

NOTE: Page numbers for previous revisions may differ from page numbers in the current version.

Changes from Revision A (September 2021) to Revision B (November 2021)	Page
• Changed preview Figure 5-2 to correct pin configuration.....	3

Changes from Revision * (October 2020) to Revision A (September 2021)	Page
• Changed OPA3S328 device in RGR (VQFN-20) package from advanced information (preview) to production data (active).....	1

5 Pin Configuration and Functions

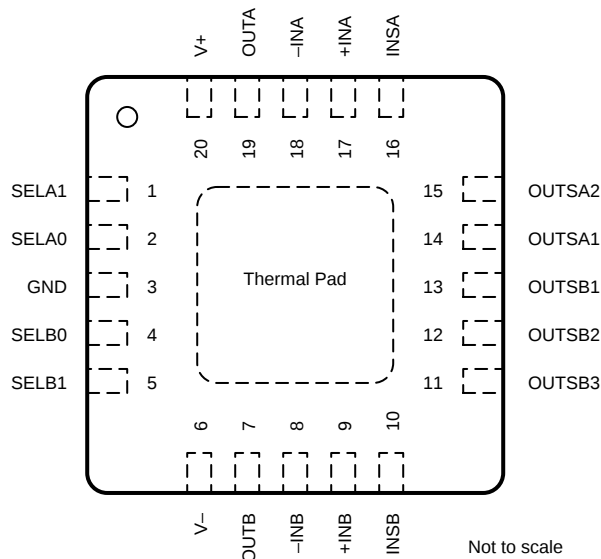

Figure 5-1. OPA3S328 RGR (20-Pin VQFN) Package, Top View

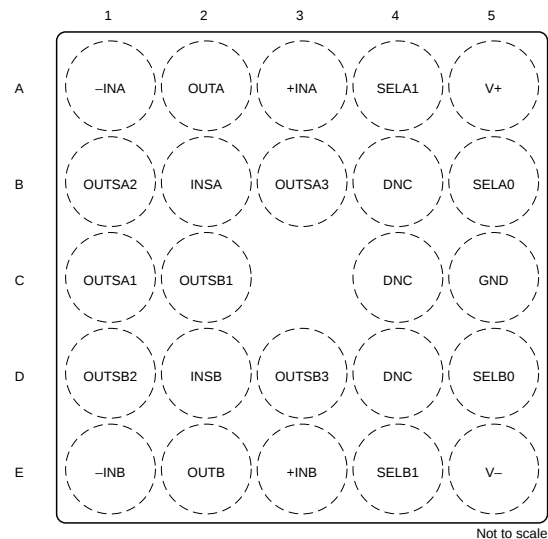

Figure 5-2. OPA3S328 YBJ (24-Pin DSBGA Preview) Package, Top View

Table 5-1. Pin Functions

NAME	PIN		TYPE	DESCRIPTION
	NO.			
	RGR (VQFN)	YBJ (DSBGA)		
DNC	—	B4, C4, D4	—	Do not connect
GND	3	C5	Ground	Digital ground pin
-INA	18	A1	Input	Negative (inverting) input for amplifier A
-INB	8	E1	Input	Negative (inverting) input for amplifier B
+INA	17	A3	Input	Positive (noninverting) input for amplifier A
+INB	9	E3	Input	Positive (noninverting) input for amplifier B
INSA	16	B2	Input/Output	Switch A1, A2, A3 input
INSB	10	D2	Input/Output	Switch B1, B2, B3 input
OUTA	19	A2	Output	Output of amplifier A
OUTB	7	E2	Output	Output of amplifier B
OUTSA1	14	C1	Input/Output	Switch A1 output
OUTSA2	15	B1	Input/Output	Switch A2 output
OUTSA3	—	B3	Input/Output	Switch A3 output
OUTSB1	13	C2	Input/Output	Switch B1 output
OUTSB2	12	D1	Input/Output	Switch B2 output
OUTSB3	11	D3	Input/Output	Switch B3 output
SELA0	2	B5	Input	Input select for switch matrix A
SELA1	1	A4	Input	Input select for switch matrix A
SELB0	4	D5	Input	Input select for switch matrix B
SELB1	5	E4	Input	Input select for switch matrix B
V-	6	E5	Power	Negative (lowest) power supply
V+	20	A5	Power	Positive (highest) power supply
Thermal Pad	Thermal Pad	—	—	Exposed thermal pad. Connect to V-

Table 5-2. Select Pin Decoder

SELA1	SELA0	SELB1	SELB0	SHUTDOWN STATUS	SWITCH CONFIGURATION					
					SWITCH A1 STATUS	SWITCH A2 STATUS	SWITCH A3 ⁽¹⁾ STATUS	SWITCH B1 STATUS	SWITCH B2 STATUS	SWITCH B3 STATUS
LOW	LOW	—	—	Amplifier A enabled	CLOSED	OPEN	OPEN	—	—	—
LOW	HIGH	—	—	Amplifier A enabled	OPEN	CLOSED	OPEN	—	—	—
HIGH	LOW	—	—	Amplifier A enabled	OPEN	OPEN	CLOSED	—	—	—
HIGH	HIGH	—	—	In special mode, the SELB0 and SELB1 decoding scheme shown here is ignored, and instead, Table 5-3 applies.	—	—	—	—	—	—
—	—	LOW	LOW	Amplifier B enabled	—	—	—	CLOSED	OPEN	OPEN
—	—	LOW	HIGH	Amplifier B enabled	—	—	—	OPEN	CLOSED	OPEN
—	—	HIGH	LOW	Amplifier B enabled	—	—	—	OPEN	OPEN	CLOSED
—	—	HIGH	HIGH	Amplifier B enabled	—	—	—	OPEN	OPEN	OPEN

(1) Switch A3 is available in the YBJ (DSBGA-24) package option only.

Table 5-3. Select Pin Decoder in Special Mode: SELA0 = SELA1 = HIGH

SELA1	SELA0	SELB1	SELB0	SHUTDOWN STATUS	SWITCH CONFIGURATION					
					SWITCH A1 STATUS	SWITCH A2 STATUS	SWITCH A3 ⁽¹⁾ STATUS	SWITCH B1 STATUS	SWITCH B2 STATUS	SWITCH B3 STATUS
HIGH	HIGH	LOW	LOW	Amplifier A in power down and amplifier B enabled	OPEN	OPEN	OPEN	OPEN	OPEN	OPEN
HIGH	HIGH	LOW	HIGH	Amplifier A enabled and amplifier B in power down	OPEN	OPEN	OPEN	OPEN	OPEN	OPEN
HIGH	HIGH	HIGH	LOW	Both Amplifier A and amplifier B enabled	OPEN	OPEN	OPEN	OPEN	OPEN	OPEN
HIGH	HIGH	HIGH	HIGH	Both Amplifier A and amplifier B in power down	OPEN	OPEN	OPEN	OPEN	OPEN	OPEN

(1) Switch A3 is available in the YBJ (DSBGA-24) package option only.

6 Specifications

6.1 Absolute Maximum Ratings

over operating free-air temperature range (unless otherwise noted) ⁽¹⁾

		MIN	MAX	UNIT
V _S	Supply voltage, V _S = (V+) – (V–)	–0.3	6	V
	Input voltage, all pins	(V–) – 0.3	(V+) + 0.3	V
	Input current (INA+, INA–, INB+, INB–, INSA/B, OUTSA/B/1/2/3)	–10	+10	mA
	Output short-circuit ⁽²⁾	Continuous	Continuous	
T _A	Operating temperature	–55	150	°C
T _{stg}	Storage temperature	–65	150	°C

- (1) Operation outside the Absolute Maximum Ratings may cause permanent device damage. Absolute Maximum Ratings do not imply functional operation of the device at these or any other conditions beyond those listed under Recommended Operating Conditions. If used outside the Recommended Operating Conditions but within the Absolute Maximum Ratings, the device may not be fully functional, and this may affect device reliability, functionality, performance, and shorten the device lifetime.
- (2) Short-circuit to ground, one amplifier per package.

6.2 ESD Ratings

			VALUE	UNIT
V _(ESD)	Electrostatic discharge	Human-body model (HBM), per ANSI/ESDA/JEDEC JS-001 ⁽¹⁾	2000	V
		Charged-device model (CDM), per ANSI/ESDA/JEDEC JS-002 ⁽²⁾	500	

- (1) JEDEC document JEP155 states that 500-V HBM allows safe manufacturing with a standard ESD control process.
- (2) JEDEC document JEP157 states that 250-V CDM allows safe manufacturing with a standard ESD control process.

6.3 Recommended Operating Conditions

over operating free-air temperature range (unless otherwise noted)

			MIN	NOM	MAX	UNIT
V _S	Supply voltage	Single-supply	2.2		5.5	V
		Dual-supply	±1.1		±2.75	V
V _D	Digital supply voltage, V _D = (V+) – (GND)		1.8		5.5	V
T _A	Specified temperature		–40		+125	°C

6.4 Thermal Information

THERMAL METRIC ⁽¹⁾		OPA3S328	UNIT
		RGR (VQFN)	
		20 PINS	
R _{θJA}	Junction-to-ambient thermal resistance	43.7	°C/W
R _{θJC(top)}	Junction-to-case (top) thermal resistance	41.7	°C/W
R _{θJB}	Junction-to-board thermal resistance	19.5	°C/W
Ψ _{JT}	Junction-to-top characterization parameter	0.8	°C/W
Ψ _{JB}	Junction-to-board characterization parameter	19.5	°C/W
R _{θJC(bot)}	Junction-to-case (bottom) thermal resistance	5.3	°C/W

- (1) For more information about traditional and new thermal metrics, see the [Semiconductor and IC Package Thermal Metrics](#) application report.

6.5 Electrical Characteristics

at $T_A = 25^\circ\text{C}$, $V_S = \pm 1.1\text{ V to } \pm 2.75\text{ V}$ (2.2 V to 5.5 V), $R_L = 10\text{ k}\Omega$ connected to $V_S / 2$, $V_{CM} = V_S / 2$, $V_{OUT} = V_S / 2$, and all voltages referred to V_- (unless otherwise noted)

PARAMETER		TEST CONDITIONS		MIN	TYP	MAX	UNIT
OFFSET VOLTAGE							
V_{OS}	Input offset voltage				10	± 60	μV
		$T_A = 0^\circ\text{C to } 85^\circ\text{C}$				± 90	
		$T_A = -40^\circ\text{C to } +125^\circ\text{C}$				± 175	
dV_{OS}/dT	Input offset voltage drift	$T_A = -40^\circ\text{C to } +125^\circ\text{C}$			± 0.15	± 1	$\mu\text{V}/^\circ\text{C}$
PSRR	Input offset voltage versus power supply	$V_S = \pm 1.1\text{ V to } \pm 2.75\text{ V}$			± 1	± 10	$\mu\text{V}/\text{V}$
			$T_A = -40^\circ\text{C to } +125^\circ\text{C}$			± 15	
	Channel separation	$f = \text{dc}$			140		dB
		$f = 100\text{ kHz}$			75		
INPUT BIAS CURRENT							
I_B	Amplifier input bias current				± 0.2	± 10	pA
		$T_A = 0^\circ\text{C to } 85^\circ\text{C}$				± 10	
		$T_A = -40^\circ\text{C to } +125^\circ\text{C}$				± 100	
I_{OS}	Amplifier input offset current				± 0.2	± 20	pA
		$T_A = 0^\circ\text{C to } 85^\circ\text{C}$				± 20	
		$T_A = -40^\circ\text{C to } +125^\circ\text{C}$				± 200	
NOISE							
	Input voltage noise	$f = 0.1\text{ Hz to } 10\text{ Hz}$			3		μV_{PP}
e_N	Input voltage noise density	$f = 100\text{ Hz}$			25		$\text{nV}/\sqrt{\text{Hz}}$
		$f = 1\text{ kHz}$			9.8		
		$f = 10\text{ kHz}$			6.1		
i_N	Input current noise	$f = 10\text{ kHz}$			0.125		$\text{pA}/\sqrt{\text{Hz}}$
INPUT VOLTAGE							
V_{CM}	Common-mode voltage range			$(V_-) - 0.1$		$(V_+) + 0.1$	V
CMRR	Common-mode rejection ratio	$(V_-) - 0.1\text{ V} < V_{CM} < (V_+) + 0.1\text{ V}$		106	120		dB
			$T_A = -40^\circ\text{C to } +125^\circ\text{C}$		96	110	
INPUT CAPACITANCE							
Z_{ID}	Differential				1 4		$\text{T}\Omega$ pF
Z_{ICM}	Common-mode				1 2		$\text{T}\Omega$ pF
OPEN-LOOP GAIN							
A_{OL}	Open-loop voltage gain	$(V_-) + 100\text{ mV} < V_O < (V_+) - 100\text{ mV}$		108	132		dB
			$T_A = -40^\circ\text{C to } +125^\circ\text{C}$		96	130	
		$(V_-) + 100\text{ mV} < V_O < (V_+) - 100\text{ mV}, R_L = 2\text{ k}\Omega$		106	123		
			$T_A = -40^\circ\text{C to } +125^\circ\text{C}$		90	120	
FREQUENCY RESPONSE							
GBW	Gain-bandwidth product				40		MHz
SR	Slew rate	4-V step, $G = +1$			± 30		V/ μs
t_S	Settling time	To 0.1%, 4-V step, $G = +1$			0.3		μs
		To 0.01%, 4-V step, $G = +1$			0.42		
	Overload recovery time	$V_{IN} \times G > V_S$			0.5		μs
THD+N	Total harmonic distortion + noise	$V_O = 1\text{ V}_{RMS}, G = +1, f = 1\text{ kHz}$			0.00017%		
f_{CP}	Charge pump frequency				27		MHz

6.5 Electrical Characteristics (continued)

at $T_A = 25^\circ\text{C}$, $V_S = \pm 1.1\text{ V}$ to $\pm 2.75\text{ V}$ (2.2 V to 5.5 V), $R_L = 10\text{ k}\Omega$ connected to $V_S / 2$, $V_{CM} = V_S / 2$, $V_{OUT} = V_S / 2$, and all voltages referred to V_- (unless otherwise noted)

PARAMETER		TEST CONDITIONS		MIN	TYP	MAX	UNIT
OUTPUT							
	Voltage output swing from both rails	$V_S = 2.2\text{ V}$	$R_L = 2\text{ k}\Omega$			5	mV
						15	
		$V_S = 5.5\text{ V}$	$R_L = 2\text{ k}\Omega$			5	
						15	
I_{SC}	Short-circuit current	Sinking, $V_S = 5.5\text{ V}$			-68		mA
		Sourcing, $V_S = 5.5\text{ V}$			63		
R_O	Open-loop output impedance	$f = 10\text{ kHz}$			55		Ω
OUTPUT DISABLE							
I_{QPD}	Quiescent current in power down	Total quiescent current, both amplifiers A and B disabled			30	50	μA
t_{PDOFF}	Output enable time				10		μs
t_{PD}	Output disable time				3		μs
Z_{PD}	Output impedance in power down				100 16		$\text{G}\Omega \text{pF}$
SELECT INPUTS							
V_{IH}	High level input voltage	$\text{GND} = 0\text{ V}$		1.5		V_+	V
V_{IL}	Low level input voltage	$\text{GND} = 0\text{ V}$		0		0.3	V
	GND voltage input range			(V_-)		(V_+) - 1.8	V
R_{PD}	Input pulldown resistance	SELA/B/0/1 pins			10		$\text{M}\Omega$
SWITCHES							
t_{ON}	Switching time off to on (open to close)	$R_{L_SW} = 300\ \Omega$, $C_L = 35\ \text{pF}$, $\text{INSA/B} = 5\ \text{V}$, $\text{OUTSA/B/1/2/3} = 0\ \text{V}$, $V_S = 5\ \text{V}$			1.3		μs
t_{OFF}	Switching time on to off (close to open)	$R_{L_SW} = 300\ \Omega$, $C_L = 35\ \text{pF}$, $\text{INSA/B} = 5\ \text{V}$, $\text{OUTSA/B/1/2/3} = 0\ \text{V}$, $V_S = 5\ \text{V}$			2		μs
I_{L_INS}	Switch input leakage current (INSA/B)	Switch open, $\text{INSA/B} = 5\ \text{V}$, $\text{OUTSA/B/1/2/3} = 0\ \text{V}$			30		pA
		Switch open, $\text{INSA/B} = 1.5\ \text{V}$, $\text{OUTSA/B/1/2/3} = 4.5\ \text{V}$	$T_A = 0^\circ\text{C}$ to 85°C		10	150	
					25	150	
				$T_A = -40^\circ\text{C}$ to $+125^\circ\text{C}$	82	260	
I_{L_OUTS}	Switch output leakage current (OUTSA/B/1/2/3)	Switch open, $\text{INSA/B} = 1.5\ \text{V}$, $\text{OUTSA/B/1/2/3} = 4.5\ \text{V}$			11	90	pA
			$T_A = 0^\circ\text{C}$ to 85°C		100	120	
					190	250	
				$T_A = -40^\circ\text{C}$ to $+125^\circ\text{C}$			
I_{L_ON}	Channel on leakage	Switch closed, $\text{INSA/B} = \text{OUTSA/B/1/2/3} = 5\ \text{V}$			5	20	pA
			$T_A = 0^\circ\text{C}$ to 85°C			140	
						155	
				$T_A = -40^\circ\text{C}$ to $+125^\circ\text{C}$			
C_{IN}	Switch input capacitance	Switch open, $\text{INSA/B} = 2.5\ \text{V}$			3		pF
C_{OUT}	Switch output capacitance	Switch open, $\text{OUTSA/B/1/2/3} = 2.5\ \text{V}$			0.7		pF
	Switch total capacitance	Switch closed, $\text{INSA/B} = \text{OUTSA/B/1/2/3} = 2.5\ \text{V}$			6		pF
R_{ON}	Switch on resistance	Switch closed, $V_+ = 5\ \text{V}$, $\text{INSA/B} = 2.5\ \text{V}$			84	125	Ω
			$T_A = 0^\circ\text{C}$ to 85°C		88		
				$T_A = -40^\circ\text{C}$ to $+125^\circ\text{C}$		102	
ΔR_{ON}	Switch on resistance match between channels	Switch closed, $\text{INSA/B} = 4\ \text{V}$, $V_+ = 5\ \text{V}$			0.2	2	Ω
	Switch on resistance flatness (vs input signal range)	Switch closed, $\text{INSA/B} = 0\ \text{V}$ to V_+ , $V_+ = 5\ \text{V}$			27	40	Ω
						100	
	Switch charge injection	$C_{L_SW} = 1\ \text{nF}$			6		pC
	Switch off isolation	$R_{L_SW} = 50\ \Omega$, $C_{L_SW} = 5\ \text{pF}$, $f = 1\ \text{MHz}$			84		dB

6.5 Electrical Characteristics (continued)

at $T_A = 25^\circ\text{C}$, $V_S = \pm 1.1\text{ V}$ to $\pm 2.75\text{ V}$ (2.2 V to 5.5 V), $R_L = 10\text{ k}\Omega$ connected to $V_S / 2$, $V_{CM} = V_S / 2$, $V_{OUT} = V_S / 2$, and all voltages referred to V_- (unless otherwise noted)

PARAMETER	TEST CONDITIONS	MIN	TYP	MAX	UNIT	
Switch channel-to-channel crosstalk	$R_{L_SW} = 50\ \Omega$, $C_{L_SW} = 5\ \text{pF}$, $f = 1\ \text{MHz}$		76		dB	
Switch -3 dB bandwidth	$R_{L_SW} = 50\ \Omega$, $C_{L_SW} = 5\ \text{pF}$		350		MHz	
POWER SUPPLY						
I_Q	Quiescent current per amplifier	$I_Q = 0\ \text{mA}$		3.8	4.5	mA
			$T_A = -40^\circ\text{C}$ to $+125^\circ\text{C}$		5.0	

6.6 Timing Diagram

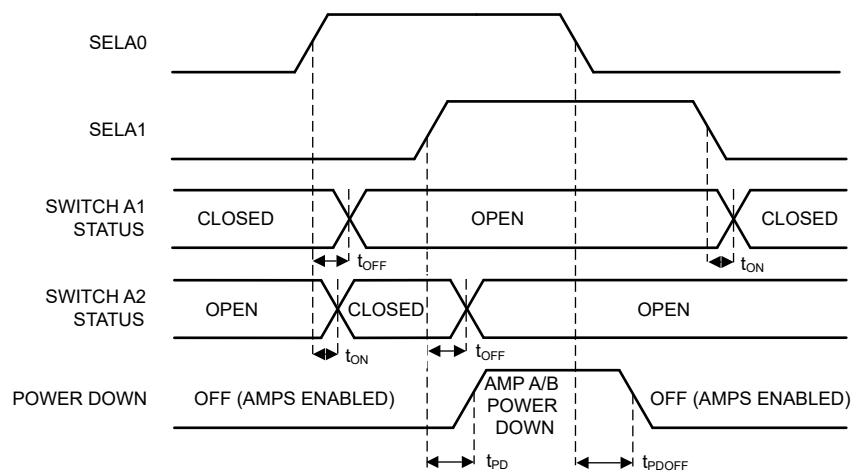

NOTE: SELA0 and SELA1 are shown. Timing for SELB0 and SELB1 to SWITCH B1, B2 and B3 transitions match SELA0 and SELA1 timing.

Figure 6-1. Select Pin Timing Diagram

6.7 Typical Characteristics

at $T_A = 25^\circ\text{C}$, $V_S = 5.5\text{ V}$, $V_{CM} = V_{OUT} = \text{mid-supply}$, $C_L = 20\text{ pF}$, and $R_L = 10\text{ k}\Omega$ (unless otherwise noted)

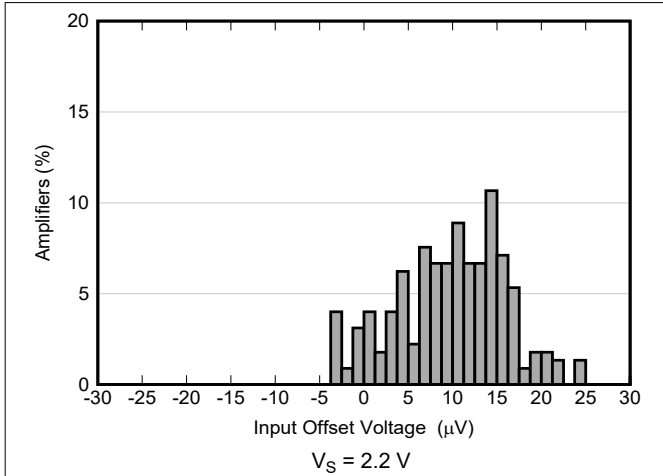

Figure 6-2. Offset Voltage Production Distribution

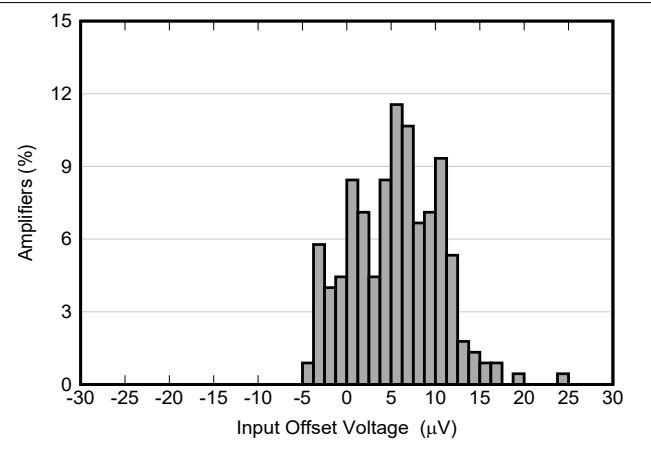

Figure 6-3. Offset Voltage Production Distribution

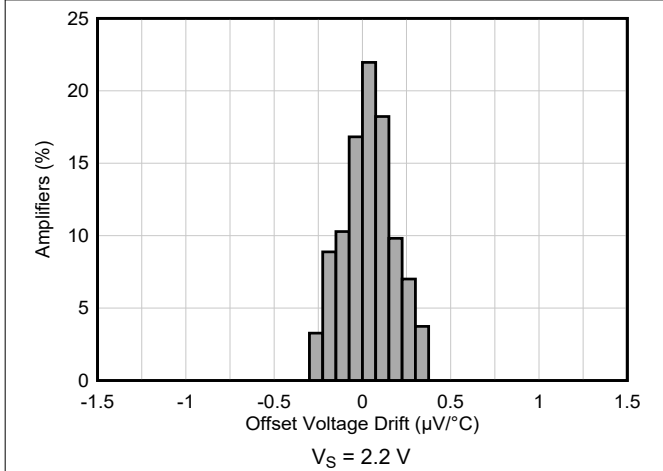

Figure 6-4. Offset Voltage Drift Distribution

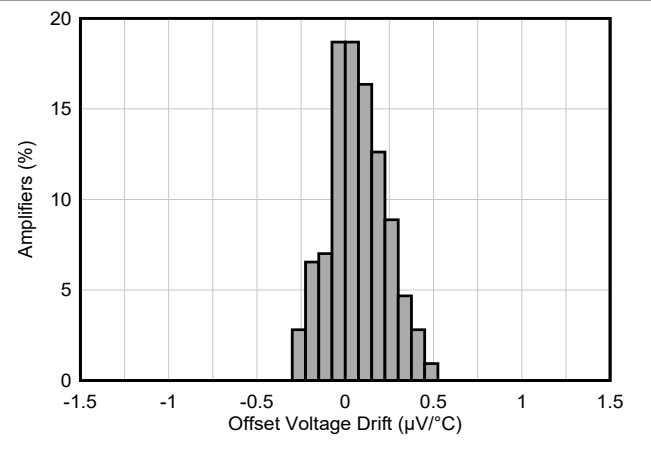

Figure 6-5. Offset Voltage Drift Distribution

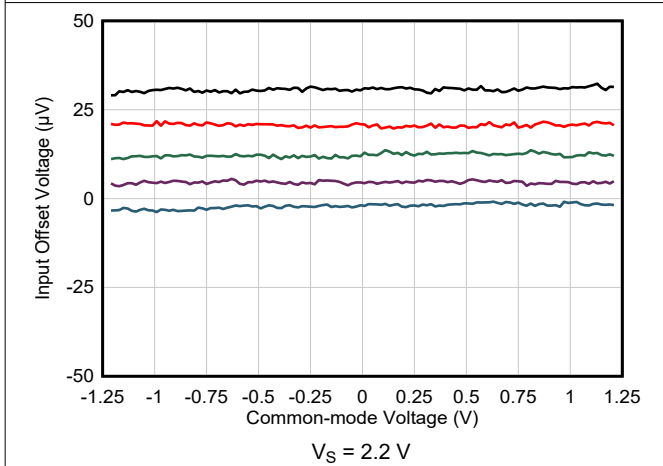

Figure 6-6. Offset Voltage vs Common-Mode Voltage

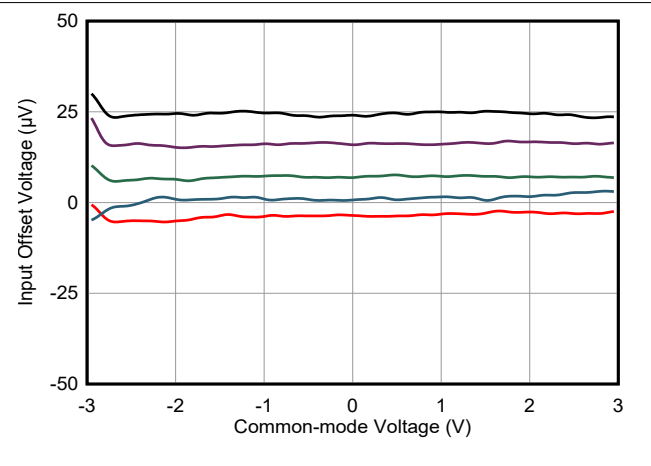
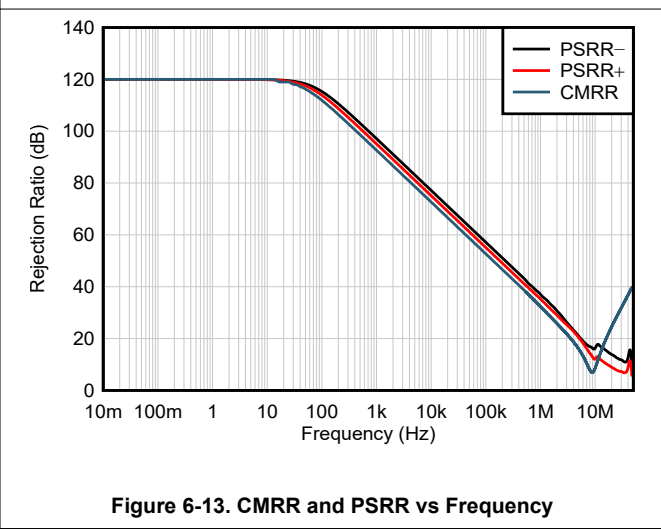
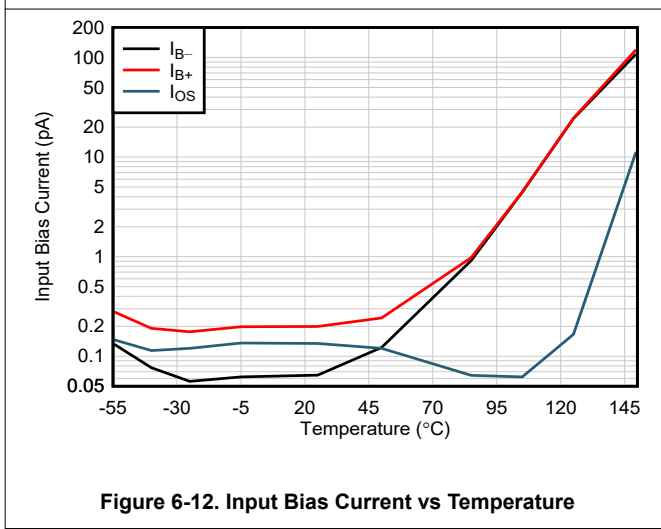
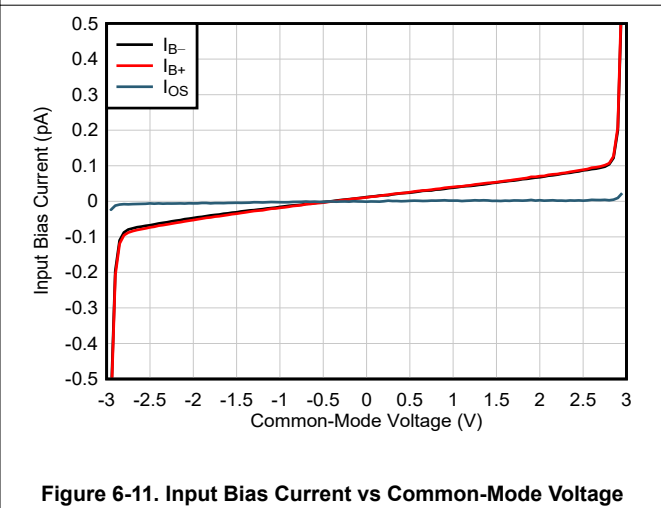
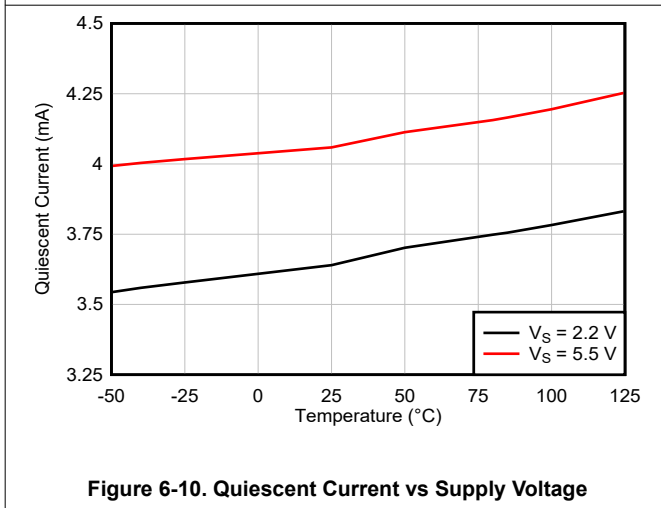
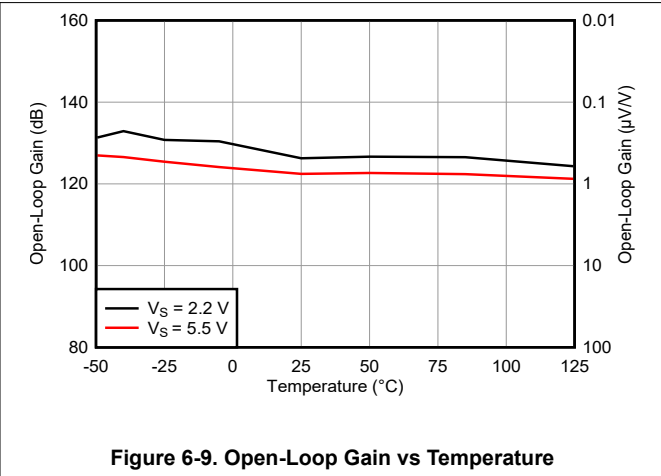
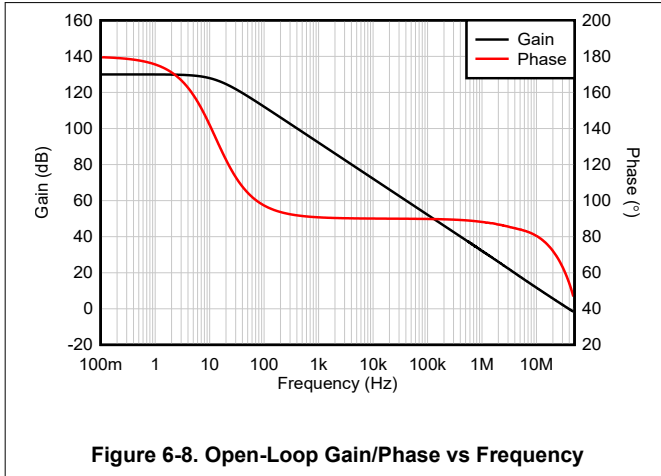

Figure 6-7. Offset Voltage vs Common-Mode Voltage

6.7 Typical Characteristics (continued)

at $T_A = 25^\circ\text{C}$, $V_S = 5.5\text{ V}$, $V_{CM} = V_{OUT} = \text{mid-supply}$, $C_L = 20\text{ pF}$, and $R_L = 10\text{ k}\Omega$ (unless otherwise noted)



6.7 Typical Characteristics (continued)

at $T_A = 25^\circ\text{C}$, $V_S = 5.5\text{ V}$, $V_{CM} = V_{OUT} = \text{mid-supply}$, $C_L = 20\text{ pF}$, and $R_L = 10\text{ k}\Omega$ (unless otherwise noted)

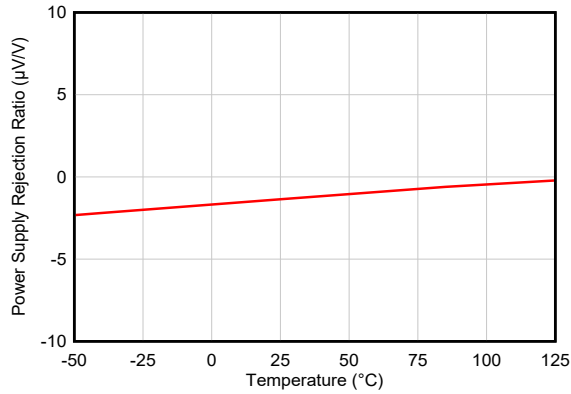

Figure 6-14. PSRR vs Temperature

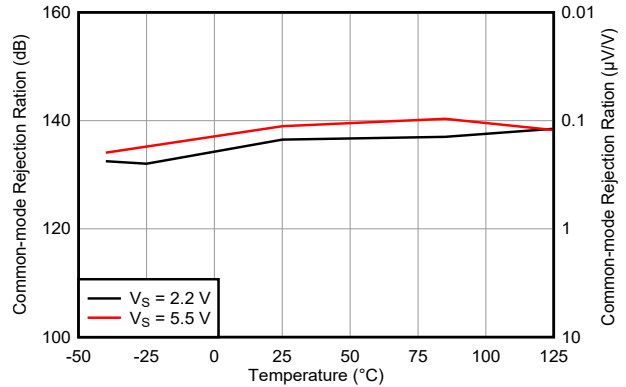

Figure 6-15. CMRR vs Temperature

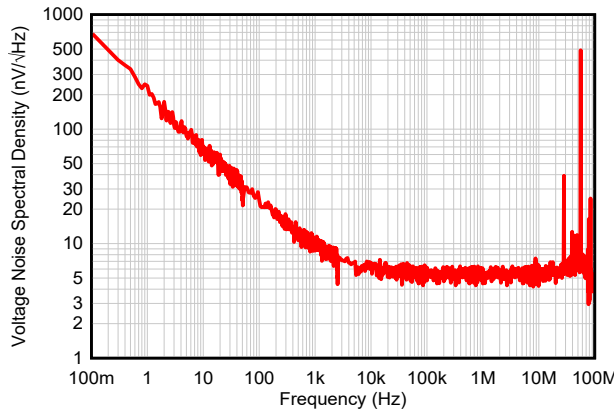

Figure 6-16. Input Voltage Noise Spectral Density vs Frequency

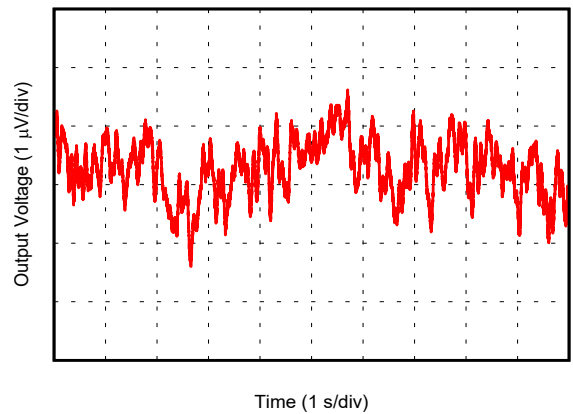

Figure 6-17. 0.1-Hz to 10-Hz Input Voltage Noise

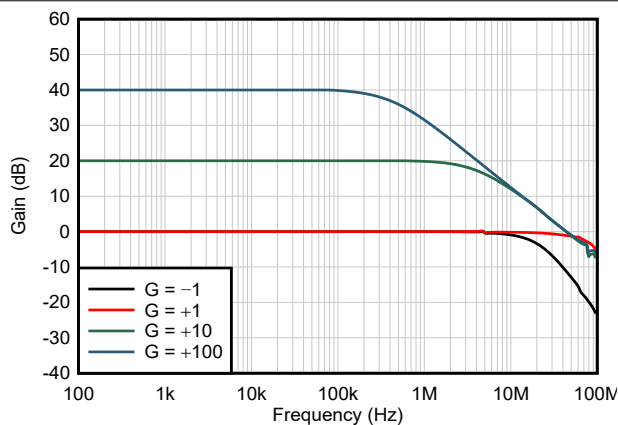

Figure 6-18. Closed-Loop Gain vs Frequency

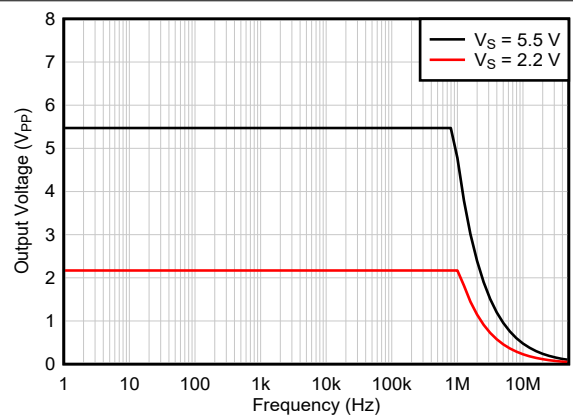

Figure 6-19. Maximum Output Voltage vs Frequency

6.7 Typical Characteristics (continued)

at $T_A = 25^\circ\text{C}$, $V_S = 5.5\text{ V}$, $V_{CM} = V_{OUT} = \text{mid-supply}$, $C_L = 20\text{ pF}$, and $R_L = 10\text{ k}\Omega$ (unless otherwise noted)

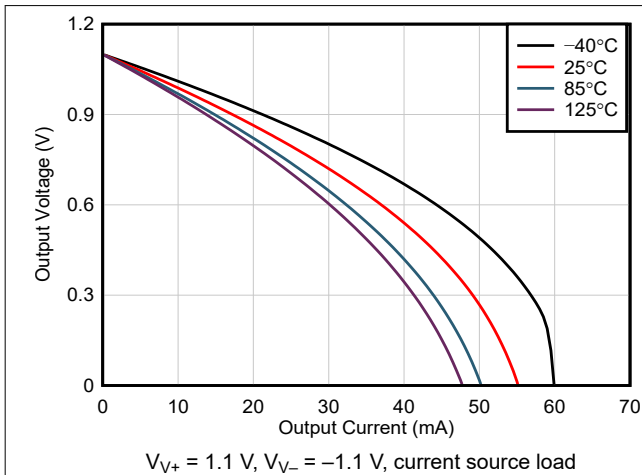

Figure 6-20. Output Voltage Swing vs Output Current

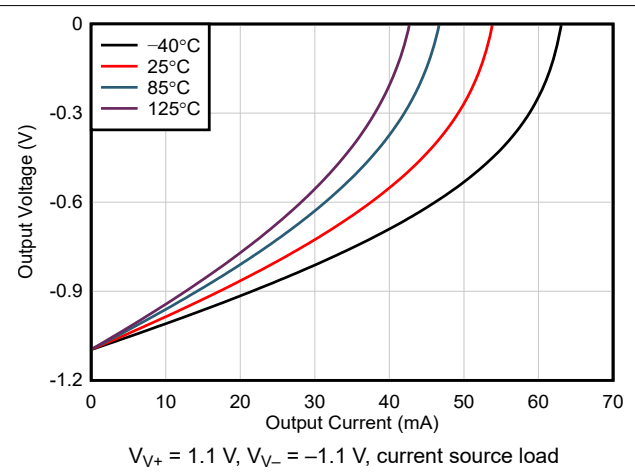

Figure 6-21. Output Voltage Swing vs Output Current

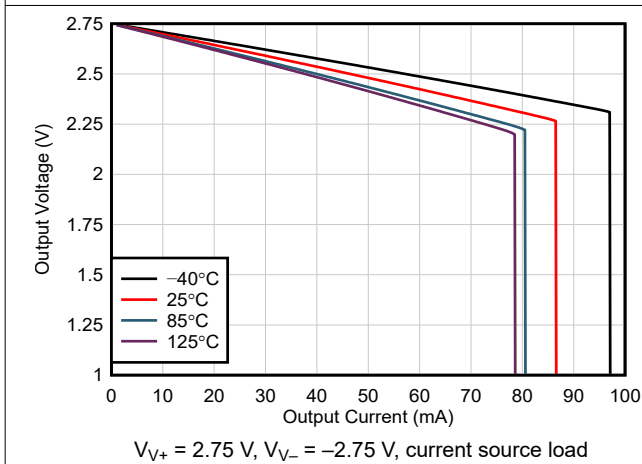

Figure 6-22. Output Voltage Swing vs Output Current

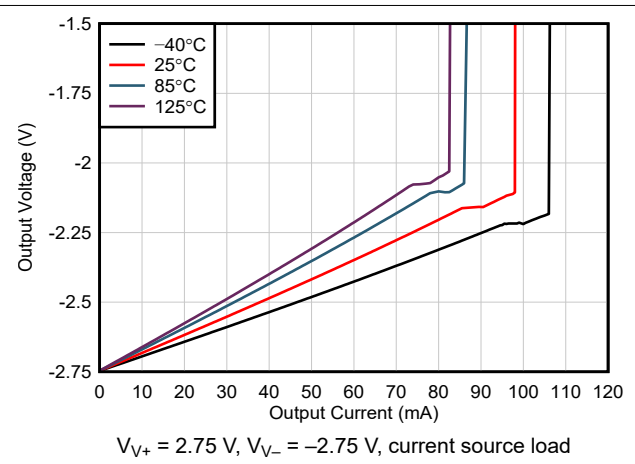

Figure 6-23. Output Voltage Swing vs Output Current

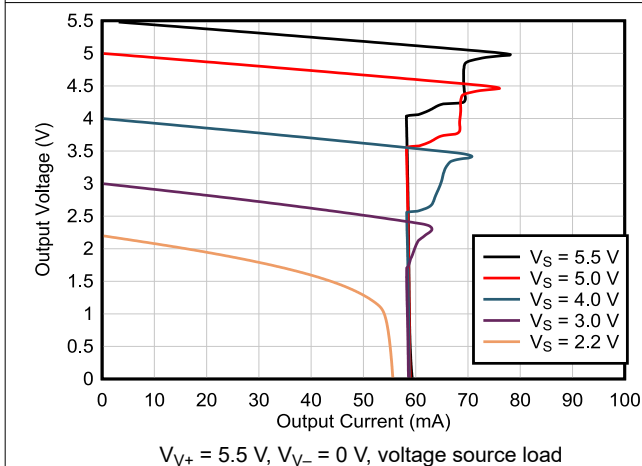

Figure 6-24. Output Voltage Swing vs Output Current

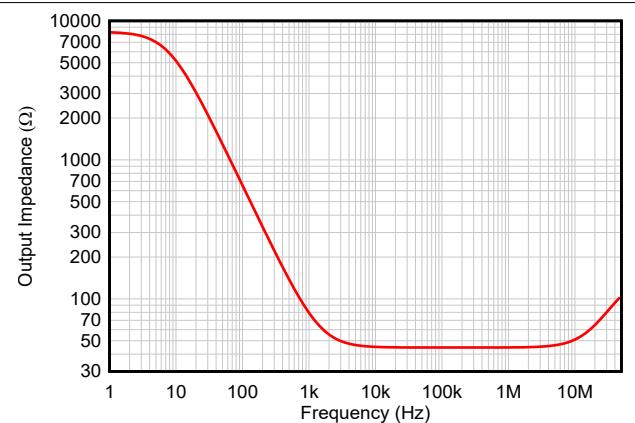

Figure 6-25. Open-Loop Output Impedance vs Frequency

6.7 Typical Characteristics (continued)

at $T_A = 25^\circ\text{C}$, $V_S = 5.5\text{ V}$, $V_{CM} = V_{OUT} = \text{mid-supply}$, $C_L = 20\text{ pF}$, and $R_L = 10\text{ k}\Omega$ (unless otherwise noted)

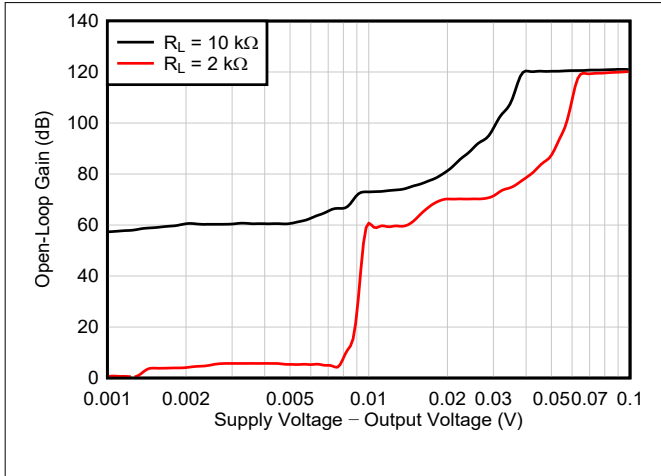

Figure 6-26. Open-Loop Gain vs Output to Supply Voltage Delta

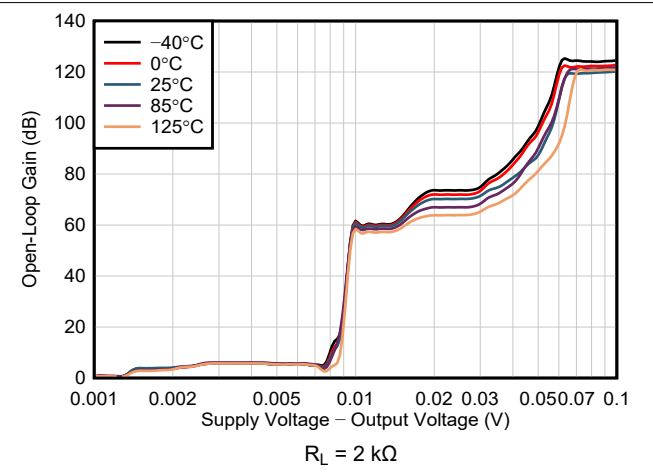

Figure 6-27. Open-Loop Gain vs Output to Supply Voltage Delta

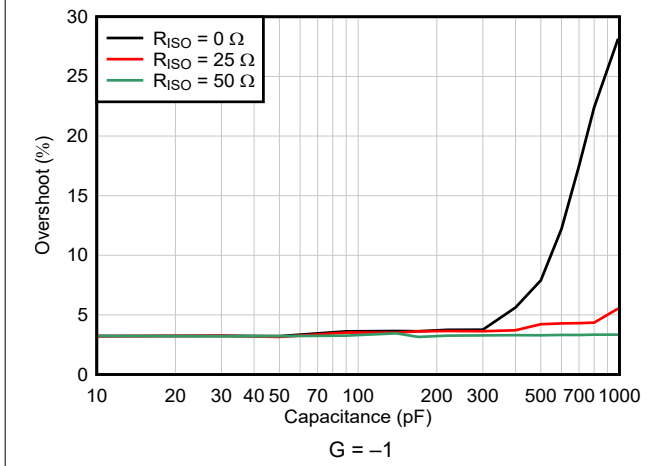

Figure 6-28. Small-Signal Overshoot vs Load Capacitance

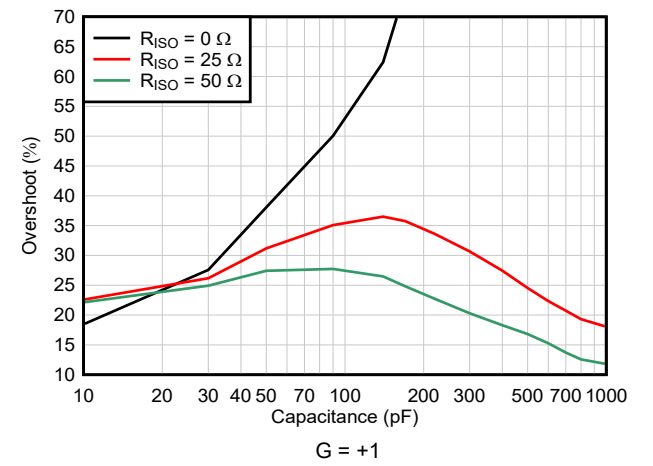

Figure 6-29. Small-Signal Overshoot vs Load Capacitance

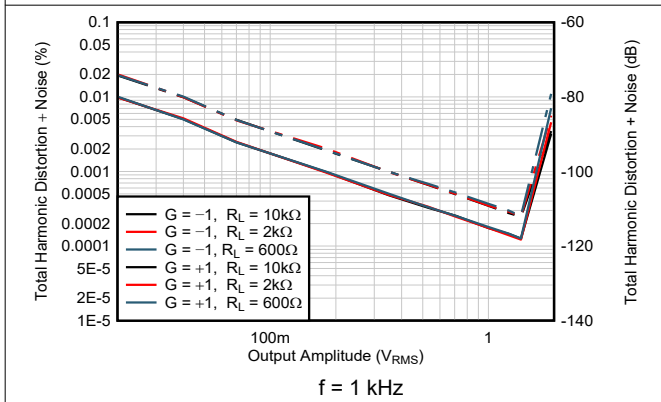

Figure 6-30. THD+N vs Amplitude

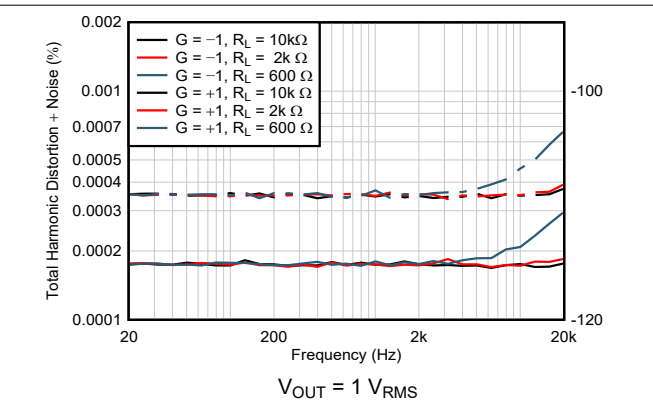

Figure 6-31. THD+N vs Frequency

6.7 Typical Characteristics (continued)

at $T_A = 25^\circ\text{C}$, $V_S = 5.5\text{ V}$, $V_{CM} = V_{OUT} = \text{mid-supply}$, $C_L = 20\text{ pF}$, and $R_L = 10\text{ k}\Omega$ (unless otherwise noted)

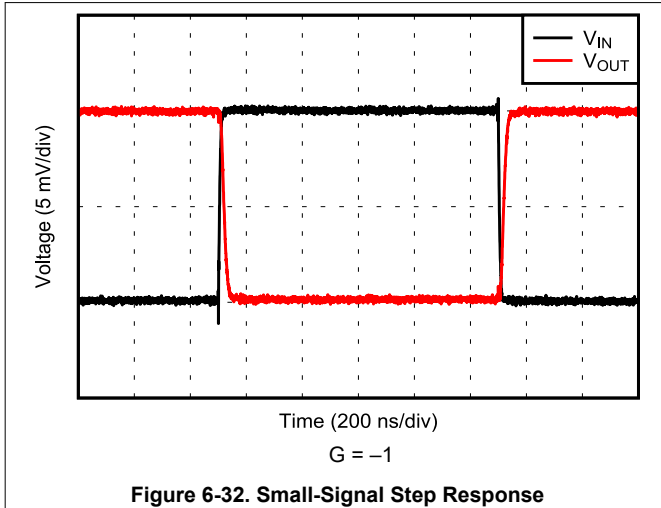

Figure 6-32. Small-Signal Step Response

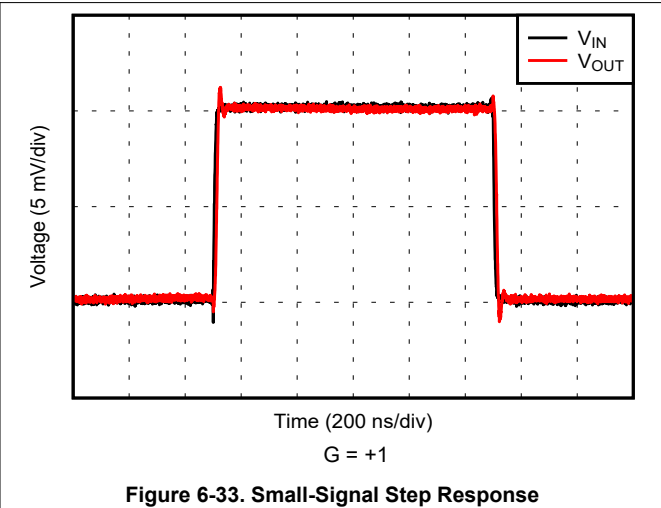

Figure 6-33. Small-Signal Step Response

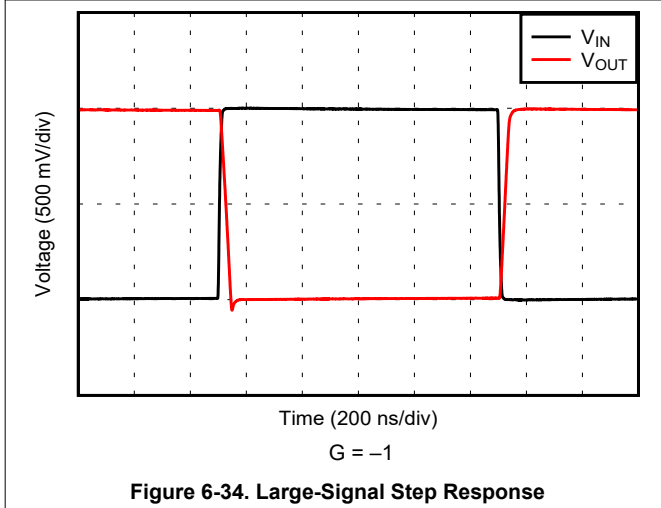

Figure 6-34. Large-Signal Step Response

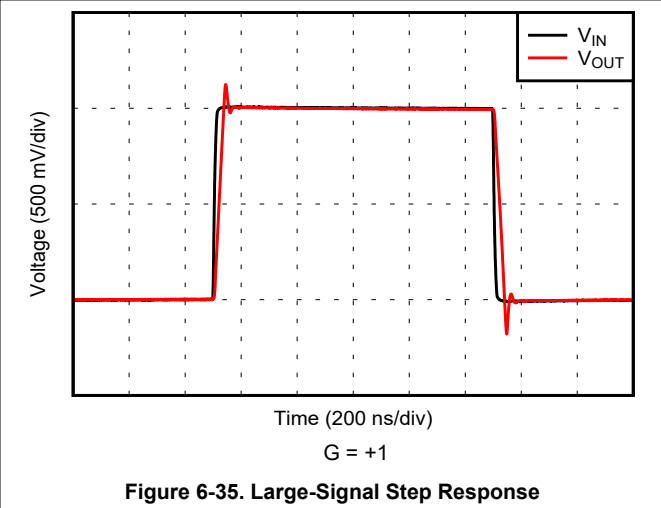

Figure 6-35. Large-Signal Step Response

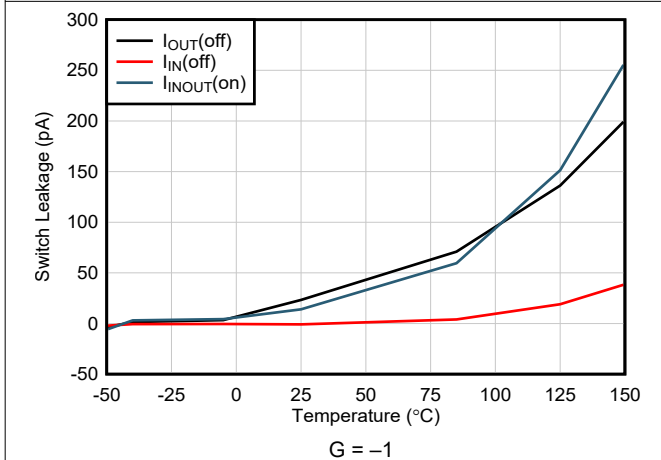

Figure 6-36. Switch Leakage Current vs Temperature

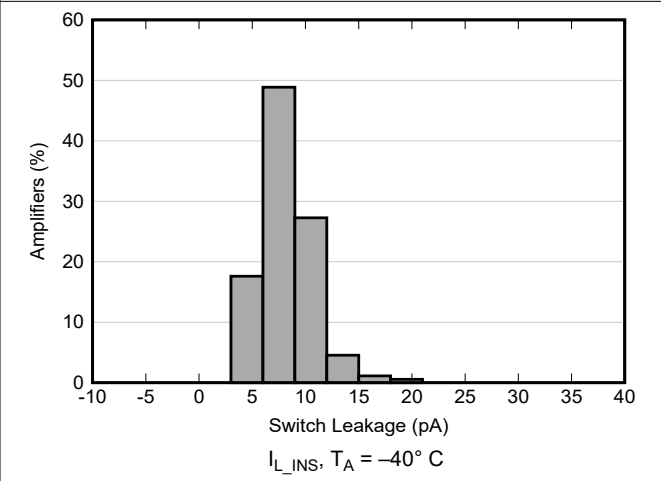

Figure 6-37. Switch Input Leakage Current Histogram

6.7 Typical Characteristics (continued)

at $T_A = 25^\circ\text{C}$, $V_S = 5.5\text{ V}$, $V_{CM} = V_{OUT} = \text{mid-supply}$, $C_L = 20\text{ pF}$, and $R_L = 10\text{ k}\Omega$ (unless otherwise noted)

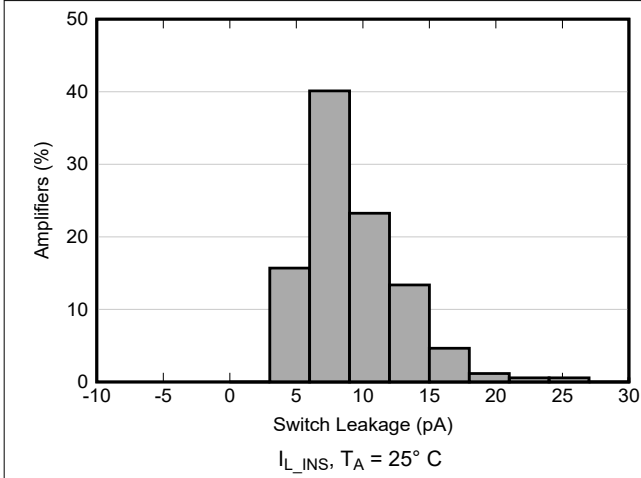

Figure 6-38. Switch Input Leakage Current Histogram

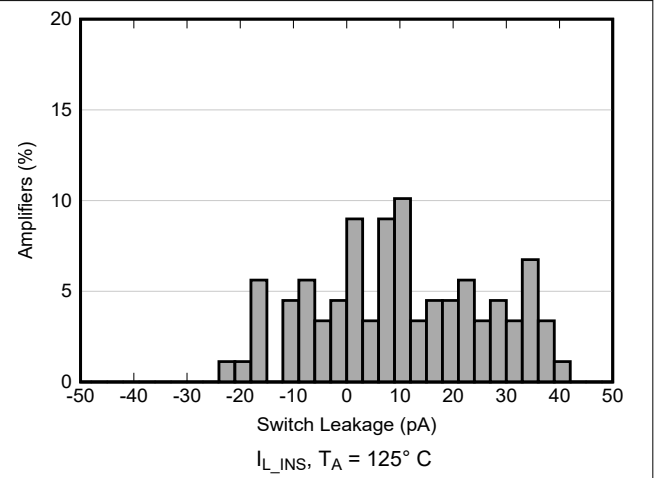

Figure 6-39. Switch Input Leakage Current Histogram

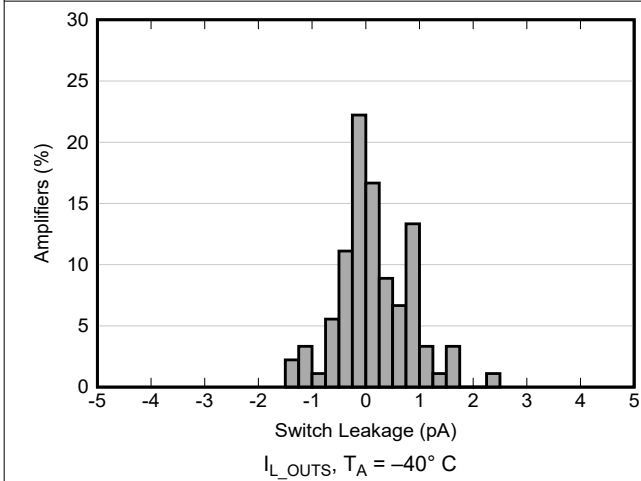

Figure 6-40. Switch Output Leakage Current Histogram

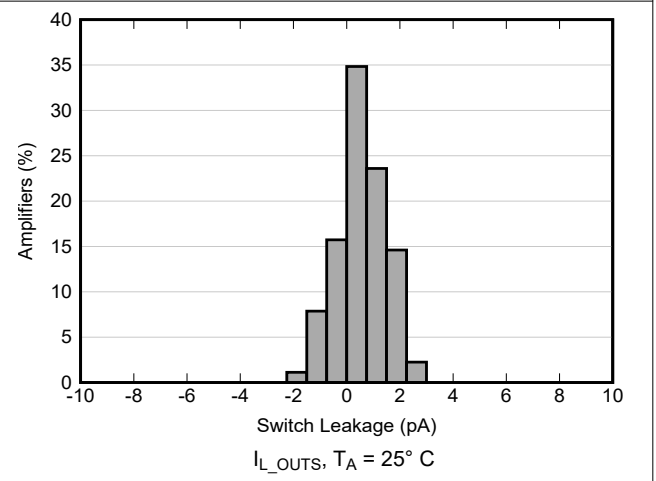

Figure 6-41. Switch Output Leakage Current Histogram

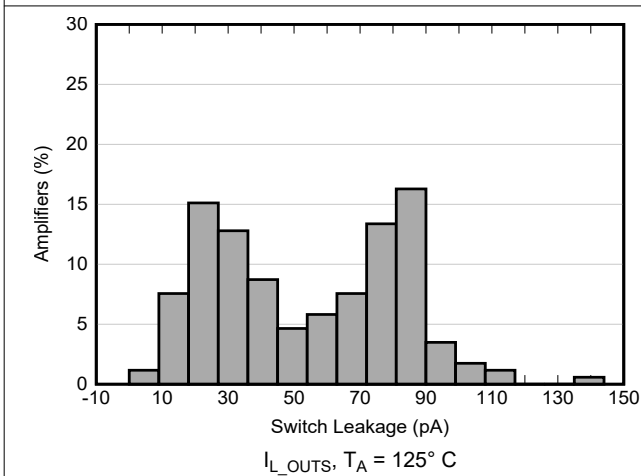

Figure 6-42. Switch Output Leakage Current Histogram

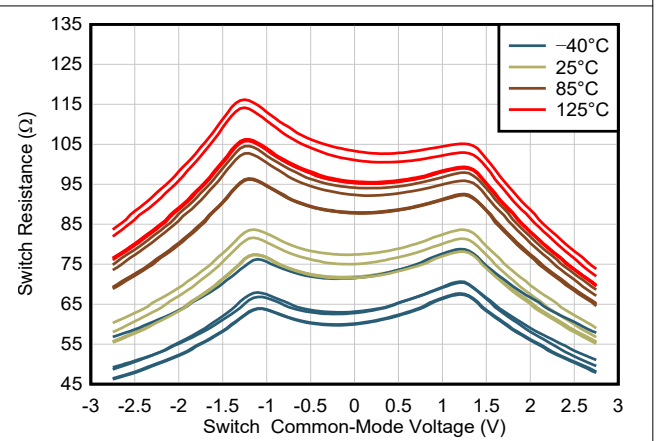

Figure 6-43. Switch On-Resistance vs Common-Mode Voltage

6.7 Typical Characteristics (continued)

at $T_A = 25^\circ\text{C}$, $V_S = 5.5\text{ V}$, $V_{CM} = V_{OUT} = \text{mid-supply}$, $C_L = 20\text{ pF}$, and $R_L = 10\text{ k}\Omega$ (unless otherwise noted)

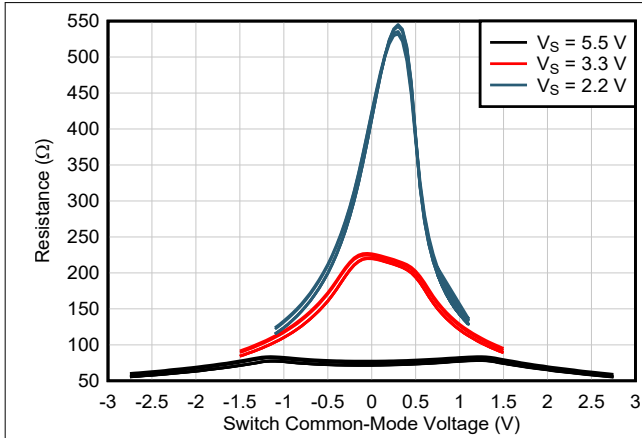

Figure 6-44. Switch On-Resistance vs Common-Mode Voltage

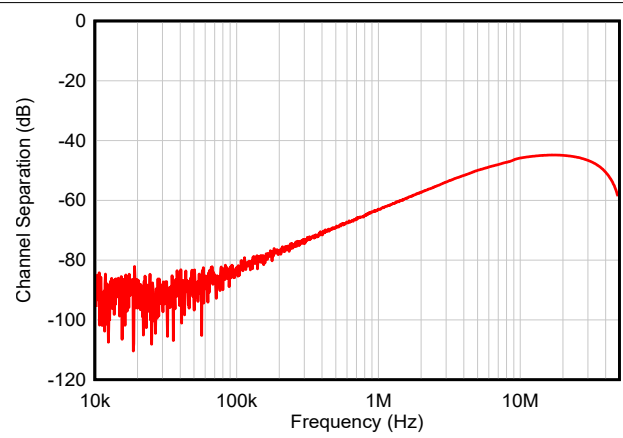

Figure 6-45. Switch Crosstalk vs Frequency

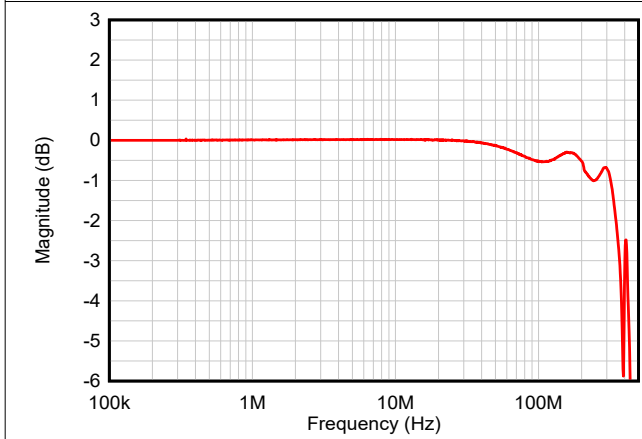

Figure 6-46. Switch Attenuation vs Frequency

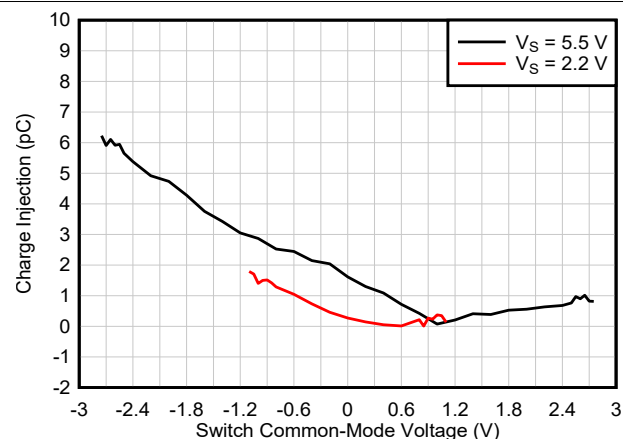

Figure 6-47. Switch Charge Injection vs Common-Mode Voltage

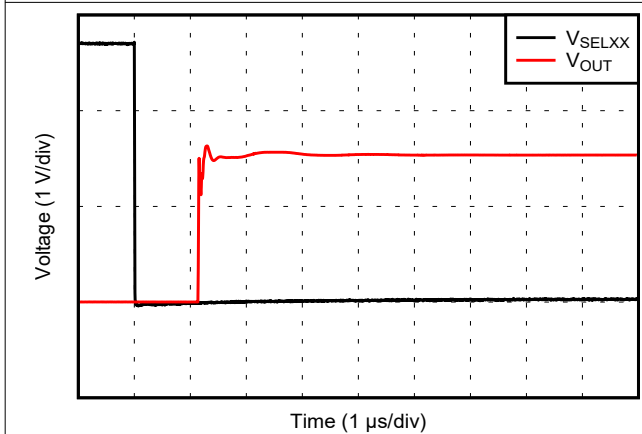

Figure 6-48. Switch Turn-on

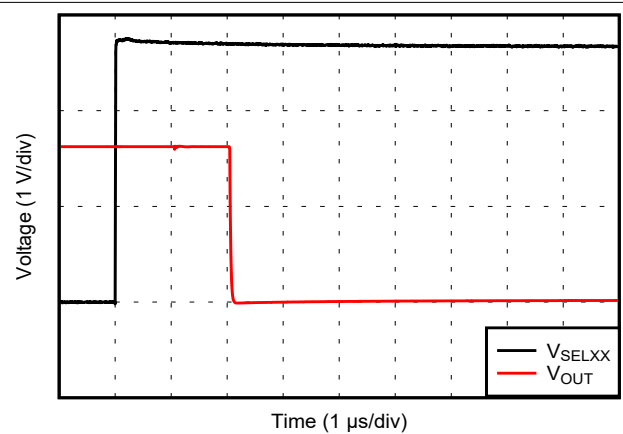

Figure 6-49. Switch Turn-off

7 Parameter Measurement Information

7.1 Switch Characterization Configurations

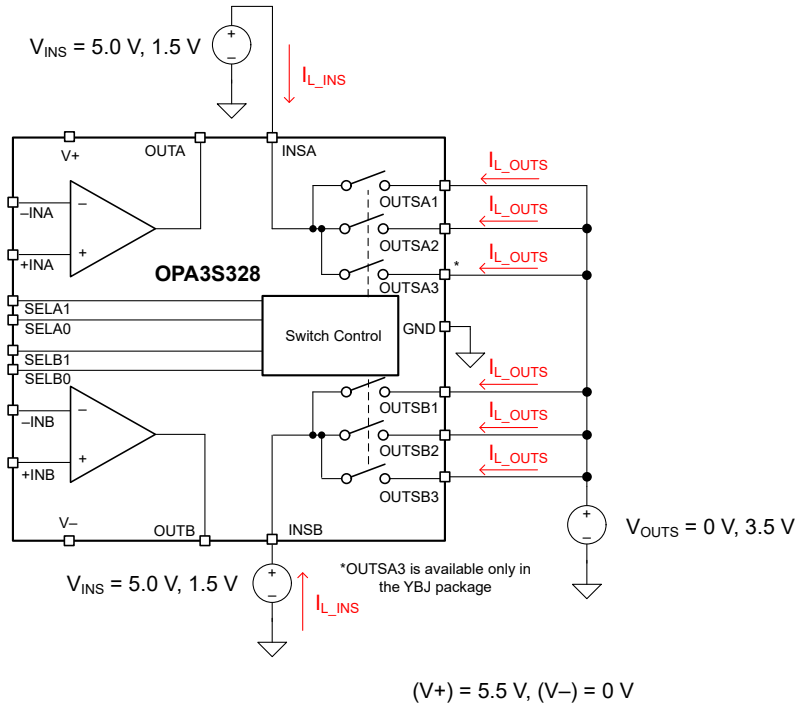

Figure 7-1. Switch Leakage Current, Open

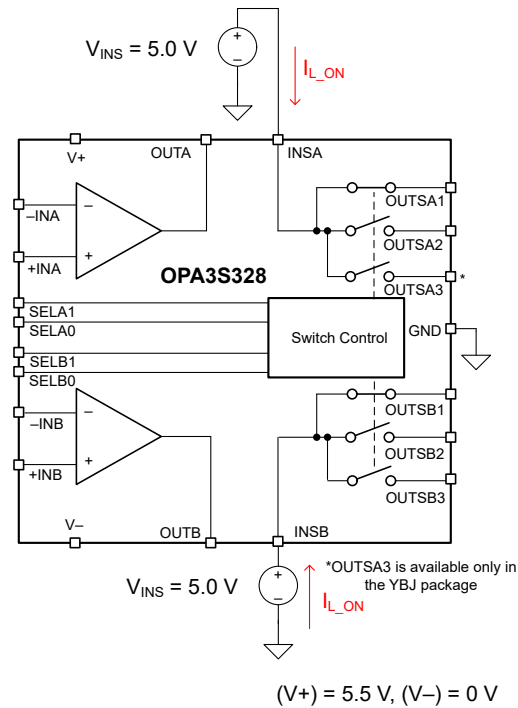

Figure 7-2. Switch Leakage Current, Closed

8 Detailed Description

8.1 Overview

The OPA3S328 features two high-speed, precision amplifiers combined with programmable switches that are designed to offer a compact sensor or optical interface for high resolution analog-to-digital converters (ADCs). Low output impedance with flat frequency characteristics and zero-crossover distortion circuitry enable high linearity over the full input common-mode range, achieving true rail-to-rail input from a 2.2-V to 5.5-V single supply. Integrated switches allow for multiple gain settings on a single amplifier stage without the need for an additional multiplexer device.

In addition to transimpedance applications, the OPA3S328 is flexible with many different application uses for a variety of equipment, such as optical modules, battery testers, medical instrumentation. This device can be used to replace larger transimpedance amplifiers, log amplifiers, programmable gain amplifiers, or programmable active filters.

8.2 Functional Block Diagram

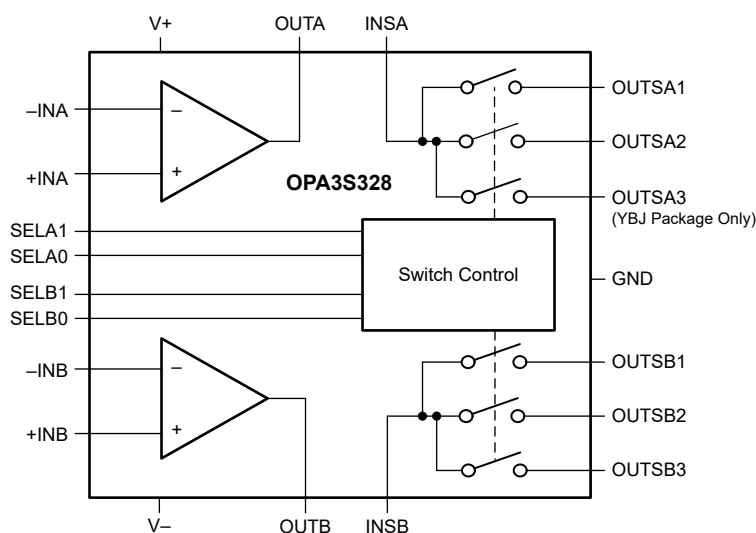

8.3 Feature Description

8.3.1 Low Operating Voltage

The OPA3S328 amplifiers and switches operate on a single-supply voltage (2.2 V to 5.5 V), or a dual-supply voltage (± 1.1 V to ± 2.75 V), making these devices highly versatile, and easy to use with low supply rails. Use local bypass ceramic capacitors (typically, 0.001 μ F to 0.1 μ F) to ground on the power-supply pins, as well as a bypass capacitor connected between the positive and negative supply pins for dual-supply operation.

The digital input pins for switch and shutdown control (SELA0, SELA1, SELB0, SELB1) are referenced to the V+ supply for the positive rail, and to the digital ground (GND pin) for the negative rail. The GND pin can be forced to any voltage greater than V- and less than V+. However, the voltage between GND and V+ must be greater than the minimum requirement for the digital circuit block operation; see [Section 8.4](#). For single-supply use cases, connect GND to V-.

The OPA3S328 amplifiers are fully specified from 2.2 V to 5.5 V and over the temperature range of -40°C to $+125^{\circ}\text{C}$.

8.3.2 Input and ESD Protection

The OPA3S328 incorporates internal electrostatic discharge (ESD) protection circuits on all pins. In the case of input and output pins, this protection primarily consists of current-steering diodes connected between the input and power-supply pins. These ESD protection diodes also provide in-circuit input overdrive protection, provided that the current is limited to 10 mA. Many input signals are inherently current-limited to less than 10 mA; therefore, a limiting resistor is not required. Figure 8-1 shows how a series input resistor (R_S) may be added to the driven input to limit the input current. The added resistor contributes thermal noise at the amplifier input; therefore, keep this value to a minimum in noise-sensitive applications.

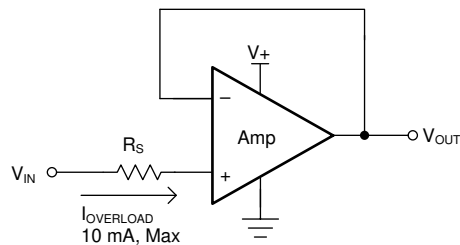

Figure 8-1. Input Current Protection

8.3.3 Programmable Switches

The OPA3S328 features integrated switches that can be used in many different configurations. Two sets of switches each have a single input (INSA and INSB) that multiplexes to two or three different outputs (OUTSA1, 2, and 3 and OUTSB1, 2, and 3). The QFN package has both a 1-to-2 switch matrix and a 1-to-3 switch matrix. The DSBGA package has two 1-to-3 switch matrices. The switches feature *make-before-break* switching, meaning that when programmed to a different switch connection, the previous switch does not change to high-impedance state until the new switch is closed, with a typical 2- μ s delay when both switches are closed. This feature keeps the amplifier from operating in an open-loop state when the switches are used in a switched-gain transimpedance configuration.

8.3.4 Rail-to-Rail Input

The OPA3S328 features true rail-to-rail input operation, with supply voltages as low as ± 1.1 V (2.2 V). The design of the OPA3S328 amplifiers include an internal charge-pump that powers the amplifier input stage with an internal supply rail at approximately 1.6 V above the external supply (V_{S+}). This internal supply rail allows the single differential input pair to operate and remain very linear over a very-wide input common-mode range. A unique zero-crossover input topology eliminates the input offset transition region typical of many rail-to-rail, complementary-input-stage, operational amplifiers. This topology allows the OPA3S328 to provide superior common-mode performance (CMRR > 120 dB, typical) over the entire common-mode input range, which extends 100 mV beyond both power-supply rails. When driving analog-to-digital converters (ADCs), the highly linear V_{CM} range of the OPA3S328 provides maximum linearity and lowest distortion.

8.3.5 Phase Reversal

The OPA3S328 op amps are designed to be immune to phase reversal when the input pins exceed the supply voltages, and thus provide further in-system stability and predictability. Figure 8-2 shows the input voltage exceeding the supply voltage without any phase reversal.

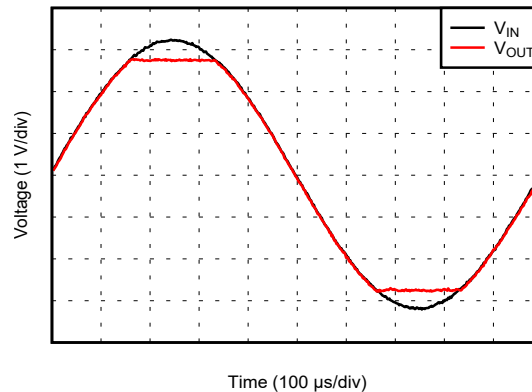

Figure 8-2. No Phase Reversal

8.4 Device Functional Modes

The OPA3S328 is specified to operate when power-supply voltages are between 2.2 V to 5.5 V (single-ended). Each amplifier can also be placed in power-down mode, as described in the in the following subsection.

8.4.1 Power-Down Mode

The OPA3S328 amplifiers can be placed into a power-down state independently. When in this power-down state, the output of the amplifier is high-impedance ($> 1 \text{ G}\Omega$) and the amplifier consumes 30 μA of quiescent current.

Power down is controlled through digital logic pins SELA0, SELA1, SELB0 and SELB1, which require a minimum 1.8 V between V+ and GND to provide functionality. For guidance on programming the device for power down, see the logic table in Table 5-3.

9 Application and Implementation

Note

Information in the following applications sections is not part of the TI component specification, and TI does not warrant its accuracy or completeness. TI's customers are responsible for determining suitability of components for their purposes, as well as validating and testing their design implementation to confirm system functionality.

9.1 Application Information

The OPA3S328 offers a unique combination of two outstanding dc and ac performance amplifiers, along with integrated low-leakage switches. This combination of devices can be configured in a variety of ways in many different circuit blocks, such as switched-gain transimpedance amplifiers, switched-gain voltage amplifiers, programmable frequency active filters, and flexible analog-to-digital converter front ends.

9.1.1 Capacitive Load and Stability

The OPA3S328 is designed to be used in high-speed applications for TIA and ADC input-driving amplifiers. As with all op amps, there may be specific instances where the OPA3S328 can become unstable. The particular op amp circuit configuration, layout, gain, and output loading are some of the factors to consider when establishing whether an amplifier is stable in operation. An op amp in the unity-gain (1-V/V) buffer configuration and driving a capacitive load exhibits a greater tendency to become unstable than an amplifier operated at a higher noise gain, as seen in [Figure 6-29](#). The capacitive load, in conjunction with the op amp output resistance, creates a pole within the feedback loop that degrades the phase margin. The degradation of the phase margin increases as the capacitive loading increases. When operating in the unity-gain configuration, the OPA3S328 remains stable with a pure capacitive load up to 100 pF.

One technique to increase the capacitive load drive capability of an amplifier operating in a unity-gain configuration is to insert a small resistor (R_S), typically 10 Ω to 50 Ω , in series with the output, as shown in [Figure 9-1](#). This resistor significantly reduces the overshoot and ringing associated with large capacitive loads.

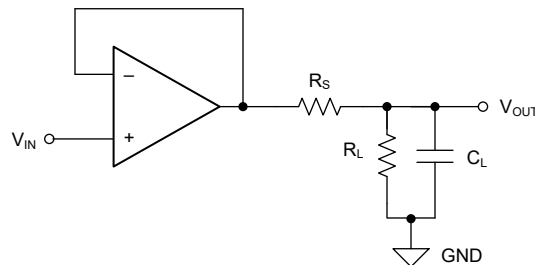

Figure 9-1. Improving Capacitive Load Drive

9.1.2 EMI Susceptibility and Input Filtering

Operational amplifiers vary in susceptibility to electromagnetic interference (EMI). If conducted EMI enters the operational amplifier, the dc offset observed at the amplifier output may shift from the nominal value while EMI is present. This shift is a result of signal rectification associated with the internal semiconductor junctions. While all operational amplifier pin functions can be affected by EMI, the input pins are likely to be the most susceptible. The OPA3S328 operational amplifiers incorporate an internal input low-pass filter that reduces the amplifiers response to EMI. Both common-mode and differential-mode filtering are provided by the input filter. The amplifier EMIRR response can be seen in [Figure 9-2](#).

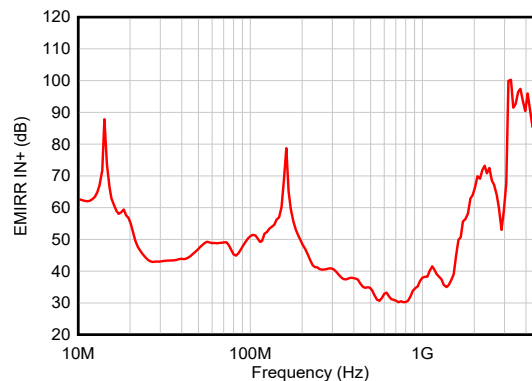

Figure 9-2. OPA3S328 EMIRR Response

9.1.3 Transimpedance Amplifier

Wide gain bandwidth, low-input bias current, low input voltage, and current noise make the OPA3S328 an excellent wideband photodiode transimpedance amplifier. Low-voltage noise is important because photodiode capacitance causes the effective noise gain of the circuit to increase at high frequency.

The key elements to a transimpedance design, as shown in [Figure 9-3](#), are the:

- expected diode capacitance (C_D), which should include the parasitic input common-mode voltage and differential-mode input capacitance
- desired transimpedance gain (R_F)
- gain-bandwidth (GBW) for the OPA3S328 (40 MHz).

With these three variables set, the feedback capacitor value (C_F) can be set to control the frequency response. C_F includes the stray capacitance of R_F , which is 0.2 pF for a typical surface-mount resistor.

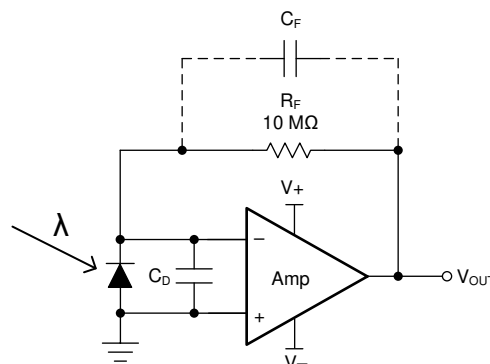

NOTE: C_F is optional to prevent gain peaking, and includes the stray capacitance of R_F .

Figure 9-3. Dual-Supply Transimpedance Amplifier

For optimal frequency response, set the feedback pole as shown in [Equation 1](#):

$$\frac{1}{2\pi R_F C_F} = \sqrt{\frac{GBW}{4\pi R_F C_D}} \quad (1)$$

Bandwidth is calculated by [Equation 2](#):

$$f_{-3dB} = \sqrt{\frac{GBW}{2\pi R_F C_D}} \quad (\text{Hz}) \quad (2)$$

For single-supply applications, the +IN input can be biased with a positive dc voltage to allow the output to reach true zero when the photodiode is not exposed to any light, and respond without the added delay that results from coming out of the negative rail. This configuration is shown in [Figure 9-4](#). This bias voltage also appears across the photodiode, providing a reverse bias for faster operation.

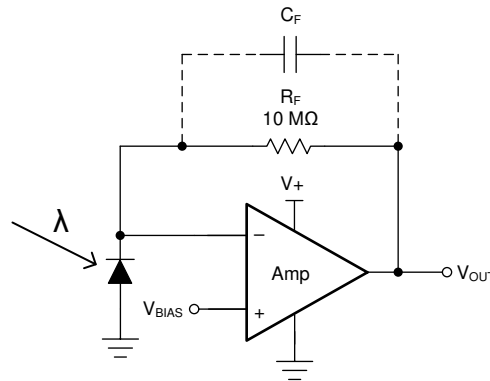

NOTE: C_F is optional to prevent gain peaking, and includes the stray capacitance of R_F .

Figure 9-4. Single-Supply Transimpedance Amplifier

For additional information, see the [Compensate Transimpedance Amplifiers Intuitively](#) application report, and the [Build a Programmable Gain Transimpedance Amplifier Using the OPA3S328](#) application report, available for download at www.ti.com.

9.1.3.1 Optimizing the Transimpedance Circuit

To achieve the best performance, select components according to the following guidelines:

1. For lowest noise, select R_F to create the total required gain. Using a lower value for R_F and adding gain after the transimpedance amplifier generally produces poorer noise performance. The noise produced by R_F increases with the square-root of R_F , whereas the signal increases linearly. Therefore, signal-to-noise ratio improves when all the required gain is placed in the transimpedance stage.
2. Minimize photodiode capacitance and stray capacitance at the summing junction (inverting input). This capacitance causes the voltage noise of the op amp to be amplified (increasing amplification at high frequency). Using a low-noise voltage source to reverse-bias a photodiode can significantly reduce capacitance. Smaller photodiodes have lower capacitance. Use optics to concentrate light on a small photodiode.
3. Noise increases with increased bandwidth. Limit the circuit bandwidth to only that required. Use a capacitor across the R_F to limit bandwidth, even if not required for stability.
4. Circuit board leakage can degrade the performance of an otherwise well-designed amplifier. Clean the circuit board carefully. A circuit-board guard trace that encircles the summing junction and is driven at the same voltage helps to control leakage.

For additional information, see the [Noise Analysis of FET Transimpedance Amplifiers](#) application report and the [Noise Analysis for High-Speed Op Amps](#) application report, available for download at www.ti.com.

9.2 Typical Application

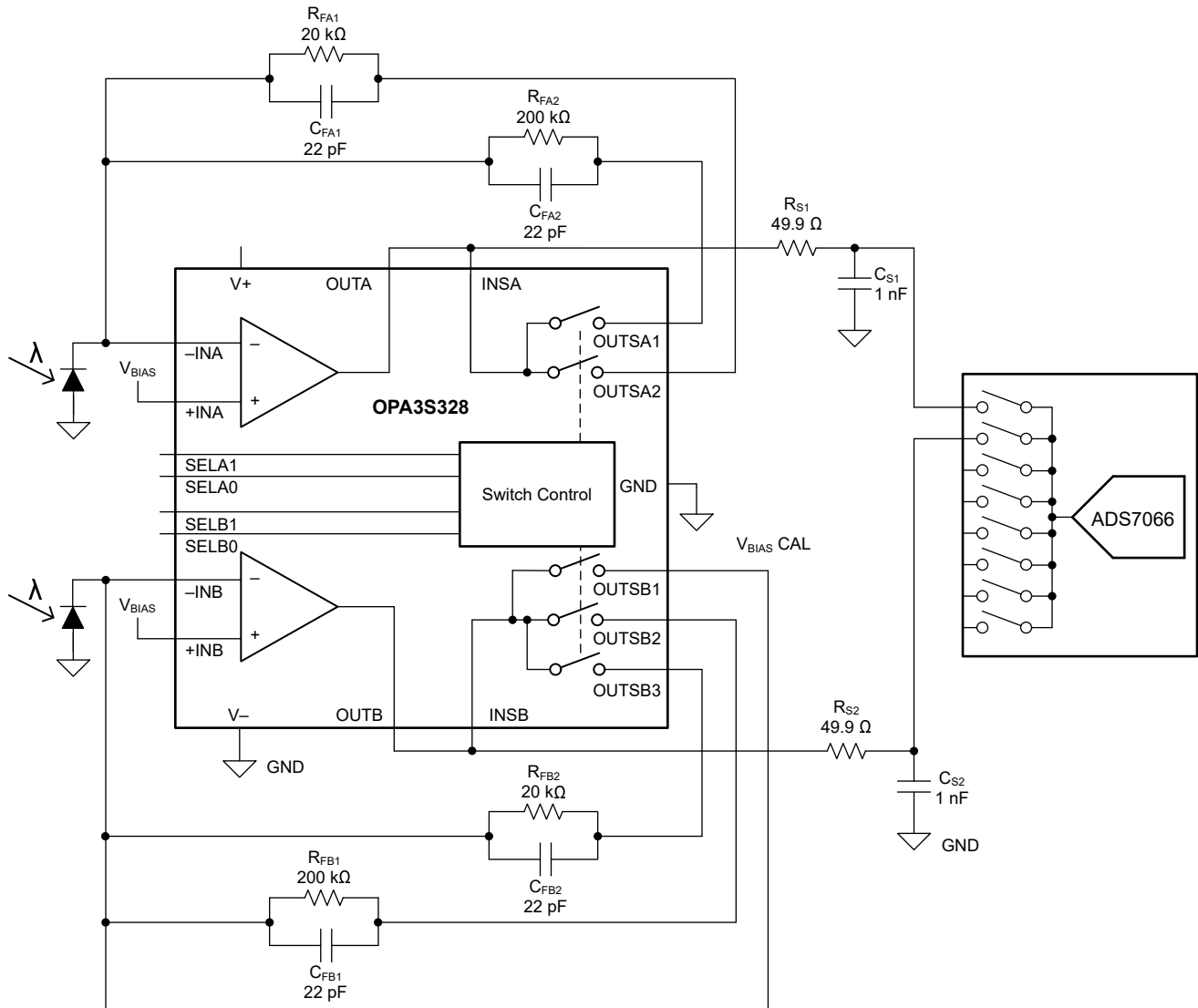

Figure 9-5. Dual Transimpedance Front End With Gain Switching

9.2.1 Design Requirements

- Gain = 0.02 V/ μ A and 0.2 V/ μ A
- Low-pass cutoff frequency = 36 kHz
- 1% accuracy from 10 nA to 100 μ A

9.2.2 Detailed Design Procedure

- Select transimpedance gains to align the measurement current range within the range of the ADC. For the [ADS7066](#), the input range is programmed to 5 V. Using this configuration, the peak current range is calculated by dividing the input range by the feedback resistor, R_{FB} , which yields 25 μA for a 200-k Ω resistor and 250 μA for a 20-k Ω feedback resistor.
- The current measurement LSB size is $5\text{ V} / (R_F \times 65536)$. The result yields 381 pA resolution for a 200-k Ω feedback resistor, and 3.81 nA resolution for a 20-k Ω resistor.
- A dc voltage is used on the noninverting terminal of the amplifier for two important reasons. The first reason is to reverse-bias the photodiode, which helps reduce photodiode capacitance and makes sure the photodiode does not operate in a forward-bias state. The second reason is to keep the output voltage of the amplifier from coming too close to the negative supply (V_-) voltage when the input current is zero. If the output voltage comes within approximately 40 mV (assuming a 10-k Ω load), the amplifier enters a saturation state, which results in loss of open-loop gain and slow transient response in order to exit the state (overload recovery). Typically 100 mV is enough to make sure that the amplifier does not saturate.
- A feedback capacitor can be used to help the stability of the circuit. Typically, if the feedback capacitor has a higher capacitance than the total input capacitance, advanced compensation schemes are not necessary to maintain stability of the amplifier along with the capacitance of the photodiode. This configuration can limit the usable bandwidth of the circuit; see [Section 9.1.3.1](#) for further details.

9.2.3 Application Curve

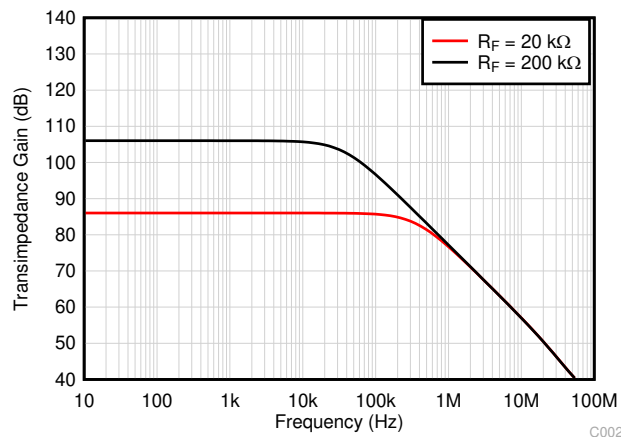

Figure 9-6. OPA3S328 Transimpedance Gain

10 Power Supply Recommendations

The OPA3S328 is specified for operation from 2.2 V to 5.5 V ($\pm 1.1\text{ V}$ to $\pm 2.75\text{ V}$), and many specifications apply from -40°C to $+125^\circ\text{C}$.

CAUTION

Supply voltages larger than 6 V can permanently damage the device; see [Section 6.1](#).

Place 0.1- μF bypass capacitors close to the power-supply pins to reduce errors coupling in from noisy or high-impedance power supplies. For more detailed information on bypass capacitor placement, see [Section 11](#).

11 Layout

11.1 Layout Guidelines

The OPA3S328 contains two wideband amplifiers and an integrated charge pump. To realize the full operational performance of the device and remove the noise from the charge pump circuit, good high-frequency PCB layout practices must be employed. The bypass capacitors must be connected between each supply pin and ground as close to the device as possible. Additionally, in dual-supply systems, there must be a ceramic bypass capacitor between the supply pins. Use bypass capacitor traces designed for minimum inductance.

11.2 Layout Example

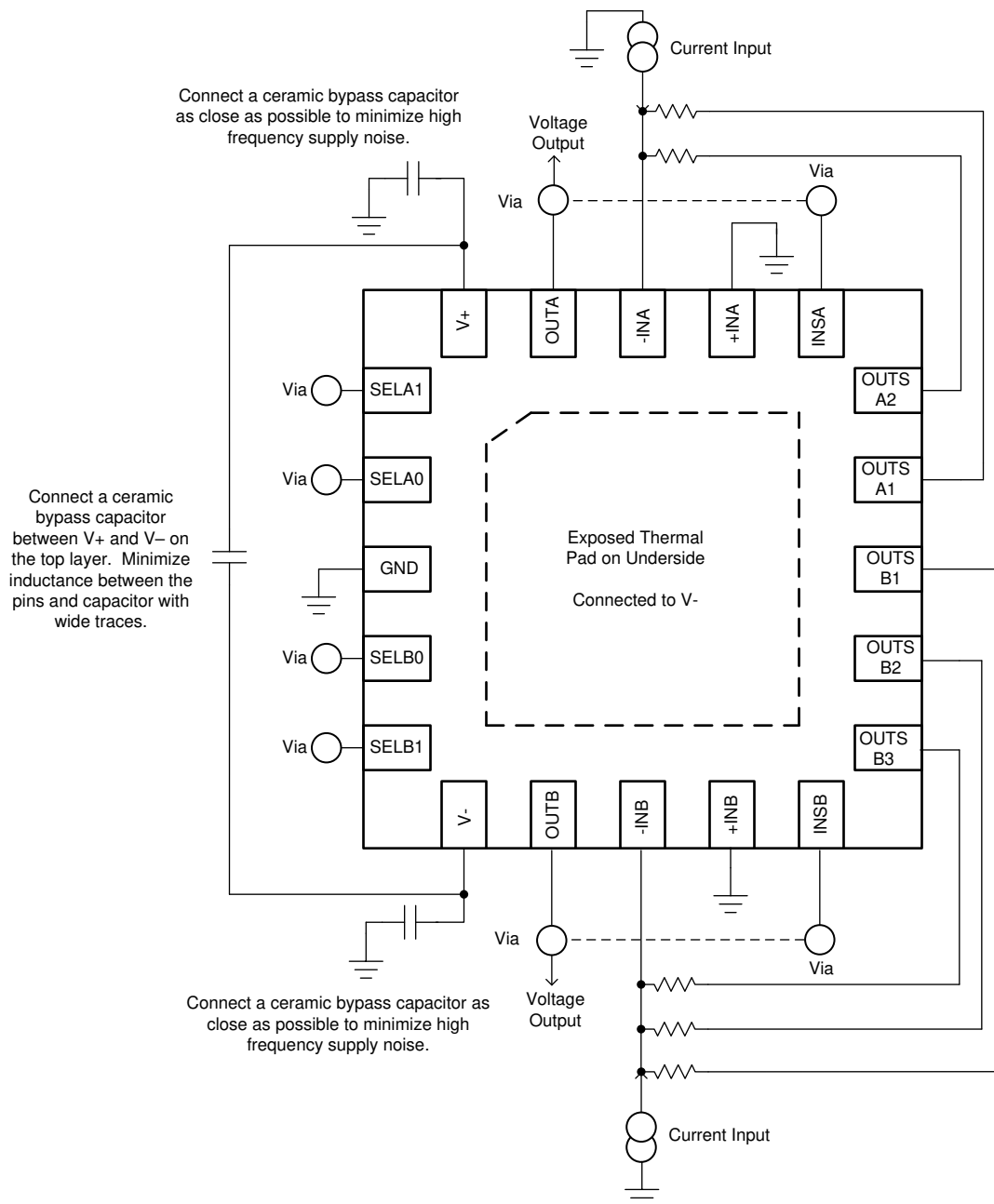

Figure 11-1. Layout Example

12 Device and Documentation Support

12.1 Device Support

12.1.1 Development Support

12.1.1.1 PSpice® for TI

PSpice® for TI is a design and simulation environment that helps evaluate performance of analog circuits. Create subsystem designs and prototype solutions before committing to layout and fabrication, reducing development cost and time to market.

12.1.1.2 TINA-TI™ Simulation Software (Free Download)

TINA™ is a simple, powerful, and easy-to-use circuit simulation program based on a SPICE engine. TINA-TI™ simulation software is a free, fully-functional version of the TINA software, preloaded with a library of macro models in addition to a range of both passive and active models. TINA-TI software provides all the conventional dc, transient, and frequency domain analysis of SPICE, as well as additional design capabilities.

Available as a [free download](#) from the Analog eLab Design Center, TINA-TI software offers extensive post-processing capability that allows users to format results in a variety of ways. Virtual instruments offer the ability to select input waveforms and probe circuit nodes, voltages, and waveforms, creating a dynamic quick-start tool.

Note

These files require that either the TINA software (from DesignSoft™) or TINA-TI software be installed. Download the free TINA-TI software from the [TINA-TI folder](#).

12.1.1.3 TI Precision Designs

TI Precision Designs are analog solutions created by TI's precision analog applications experts and offer the theory of operation, component selection, simulation, complete PCB schematic and layout, bill of materials, and measured performance of many useful circuits. TI Precision Designs are available online at <http://www.ti.com/ww/en/analog/precision-designs/>.

12.1.1.4 WEBENCH® Filter Designer

WEBENCH® Filter Designer is a simple, powerful, and easy-to-use active filter design program. The WEBENCH® Filter Designer lets you create optimized filter designs using a selection of TI operational amplifiers and passive components from TI's vendor partners.

Available as a web-based tool from the WEBENCH® Design Center, [WEBENCH® Filter Designer](#) allows you to design, optimize, and simulate complete multistage active filter solutions within minutes.

12.2 Documentation Support

12.2.1 Related Documentation

The following documents are relevant to using the OPA3S328, and recommended for reference. All are available for download at www.ti.com (unless otherwise noted):

- Texas Instruments, [PM2.5/PM10 Particle Sensor Analog Front-End for Air Quality Monitoring Design](#)
- Texas Instruments, [QFN/SON PCB Attachment](#)
- Texas Instruments, [Quad Flatpack No-Lead Logic Packages](#)
- Texas Instruments, [Compensate Transimpedance Amplifiers Intuitively](#)
- Texas Instruments, [Noise Analysis of FET Transimpedance Amplifiers](#)
- Texas Instruments, [Noise Analysis for High-Speed Op Amps](#)
- Texas Instruments, [Build a Programmable Gain Transimpedance Amplifier Using the OPA3S328](#)

12.3 Receiving Notification of Documentation Updates

To receive notification of documentation updates, navigate to the device product folder on ti.com. Click on *Subscribe to updates* to register and receive a weekly digest of any product information that has changed. For change details, review the revision history included in any revised document.

12.4 Support Resources

[TI E2E™ support forums](#) are an engineer's go-to source for fast, verified answers and design help — straight from the experts. Search existing answers or ask your own question to get the quick design help you need.

Linked content is provided "AS IS" by the respective contributors. They do not constitute TI specifications and do not necessarily reflect TI's views; see TI's [Terms of Use](#).

12.5 Trademarks

TINA™ and DesignSoft™ are trademarks of DesignSoft, Inc.

TINA-TI™ and TI E2E™ are trademarks of Texas Instruments.

PSpice® is a registered trademark of Cadence Design Systems, Inc.

WEBENCH® is a registered trademark of Texas Instruments.

All trademarks are the property of their respective owners.

12.6 Electrostatic Discharge Caution



This integrated circuit can be damaged by ESD. Texas Instruments recommends that all integrated circuits be handled with appropriate precautions. Failure to observe proper handling and installation procedures can cause damage.

ESD damage can range from subtle performance degradation to complete device failure. Precision integrated circuits may be more susceptible to damage because very small parametric changes could cause the device not to meet its published specifications.

12.7 Glossary

[TI Glossary](#) This glossary lists and explains terms, acronyms, and definitions.

13 Mechanical, Packaging, and Orderable Information

The following pages include mechanical, packaging, and orderable information. This information is the most current data available for the designated devices. This data is subject to change without notice and revision of this document. For browser-based versions of this data sheet, refer to the left-hand navigation.

PACKAGING INFORMATION

Orderable Device	Status (1)	Package Type	Package Drawing	Pins	Package Qty	Eco Plan (2)	Lead finish/ Ball material (6)	MSL Peak Temp (3)	Op Temp (°C)	Device Marking (4/5)	Samples
OPA3S328RGRR	ACTIVE	VQFN	RGR	20	3000	RoHS & Green	NIPDAU	Level-1-260C-UNLIM	-40 to 125	O3S328	Samples
OPA3S328RGRT	ACTIVE	VQFN	RGR	20	250	RoHS & Green	NIPDAU	Level-1-260C-UNLIM	-40 to 125	O3S328	Samples

(1) The marketing status values are defined as follows:

ACTIVE: Product device recommended for new designs.

LIFEBUY: TI has announced that the device will be discontinued, and a lifetime-buy period is in effect.

NRND: Not recommended for new designs. Device is in production to support existing customers, but TI does not recommend using this part in a new design.

PREVIEW: Device has been announced but is not in production. Samples may or may not be available.

OBSOLETE: TI has discontinued the production of the device.

(2) **RoHS:** TI defines "RoHS" to mean semiconductor products that are compliant with the current EU RoHS requirements for all 10 RoHS substances, including the requirement that RoHS substance do not exceed 0.1% by weight in homogeneous materials. Where designed to be soldered at high temperatures, "RoHS" products are suitable for use in specified lead-free processes. TI may reference these types of products as "Pb-Free".

RoHS Exempt: TI defines "RoHS Exempt" to mean products that contain lead but are compliant with EU RoHS pursuant to a specific EU RoHS exemption.

Green: TI defines "Green" to mean the content of Chlorine (Cl) and Bromine (Br) based flame retardants meet JS709B low halogen requirements of <=1000ppm threshold. Antimony trioxide based flame retardants must also meet the <=1000ppm threshold requirement.

(3) MSL, Peak Temp. - The Moisture Sensitivity Level rating according to the JEDEC industry standard classifications, and peak solder temperature.

(4) There may be additional marking, which relates to the logo, the lot trace code information, or the environmental category on the device.

(5) Multiple Device Markings will be inside parentheses. Only one Device Marking contained in parentheses and separated by a "~" will appear on a device. If a line is indented then it is a continuation of the previous line and the two combined represent the entire Device Marking for that device.

(6) Lead finish/Ball material - Orderable Devices may have multiple material finish options. Finish options are separated by a vertical ruled line. Lead finish/Ball material values may wrap to two lines if the finish value exceeds the maximum column width.

Important Information and Disclaimer:The information provided on this page represents TI's knowledge and belief as of the date that it is provided. TI bases its knowledge and belief on information provided by third parties, and makes no representation or warranty as to the accuracy of such information. Efforts are underway to better integrate information from third parties. TI has taken and continues to take reasonable steps to provide representative and accurate information but may not have conducted destructive testing or chemical analysis on incoming materials and chemicals. TI and TI suppliers consider certain information to be proprietary, and thus CAS numbers and other limited information may not be available for release.

In no event shall TI's liability arising out of such information exceed the total purchase price of the TI part(s) at issue in this document sold by TI to Customer on an annual basis.

TAPE AND REEL INFORMATION

QUADRANT ASSIGNMENTS FOR PIN 1 ORIENTATION IN TAPE

*All dimensions are nominal

Device	Package Type	Package Drawing	Pins	SPQ	Reel Diameter (mm)	Reel Width W1 (mm)	A0 (mm)	B0 (mm)	K0 (mm)	P1 (mm)	W (mm)	Pin1 Quadrant
OPA3S328RGRR	VQFN	RGR	20	3000	330.0	12.4	3.75	3.75	1.15	8.0	12.0	Q2
OPA3S328RGRT	VQFN	RGR	20	250	180.0	12.4	3.75	3.75	1.15	8.0	12.0	Q2

TAPE AND REEL BOX DIMENSIONS

*All dimensions are nominal

Device	Package Type	Package Drawing	Pins	SPQ	Length (mm)	Width (mm)	Height (mm)
OPA3S328RGRR	VQFN	RGR	20	3000	367.0	367.0	35.0
OPA3S328RGRT	VQFN	RGR	20	250	210.0	185.0	35.0

GENERIC PACKAGE VIEW

RGR 20

VQFN - 1 mm max height

3.5 x 3.5, 0.5 mm pitch

PLASTIC QUAD FLATPACK - NO LEAD

This image is a representation of the package family, actual package may vary.
Refer to the product data sheet for package details.

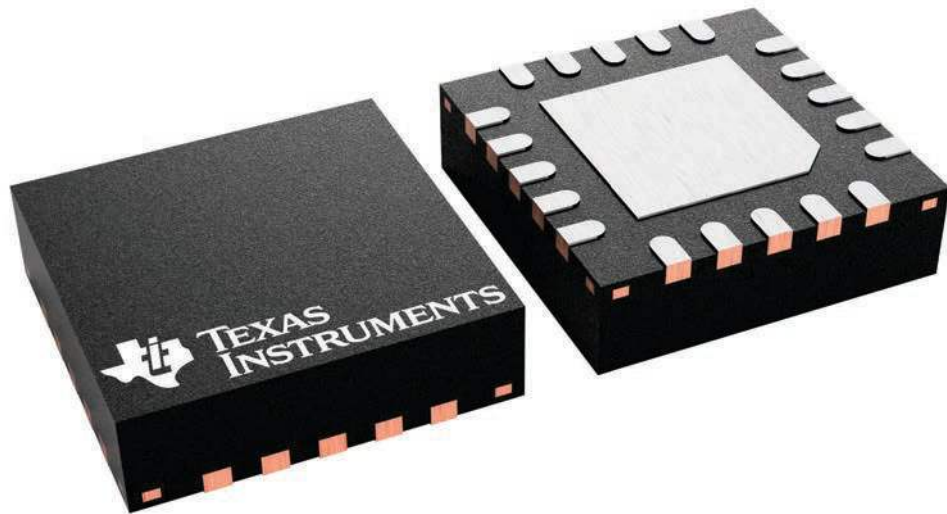

4228482/A

EXAMPLE BOARD LAYOUT

RGR0020A

VQFN - 1 mm max height

PLASTIC QUAD FLATPACK - NO LEAD

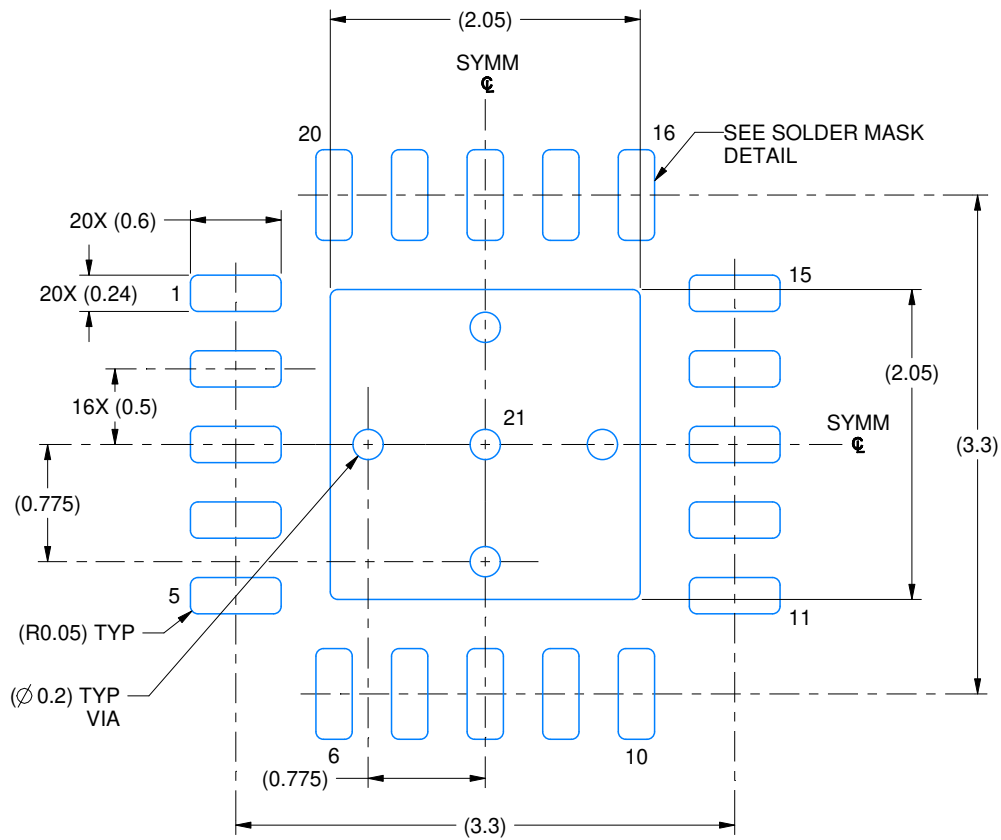

LAND PATTERN EXAMPLE
EXPOSED METAL SHOWN
SCALE: 20X

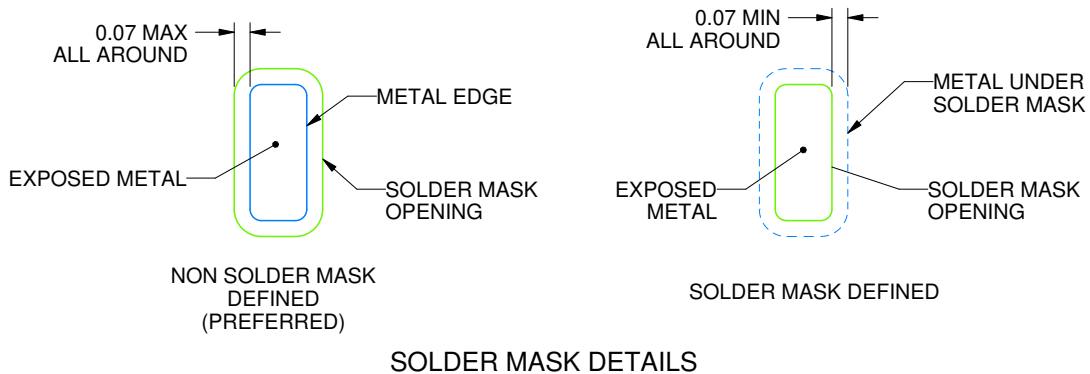

4219031/B 04/2022

NOTES: (continued)

4. This package is designed to be soldered to a thermal pad on the board. For more information, see Texas Instruments literature number SLUA271 (www.ti.com/lit/sluea271).
5. Vias are optional depending on application, refer to device data sheet. If any vias are implemented, refer to their locations shown on this view. It is recommended that vias under paste be filled, plugged or tented.

EXAMPLE STENCIL DESIGN

RGR0020A

VQFN - 1 mm max height

PLASTIC QUAD FLATPACK - NO LEAD

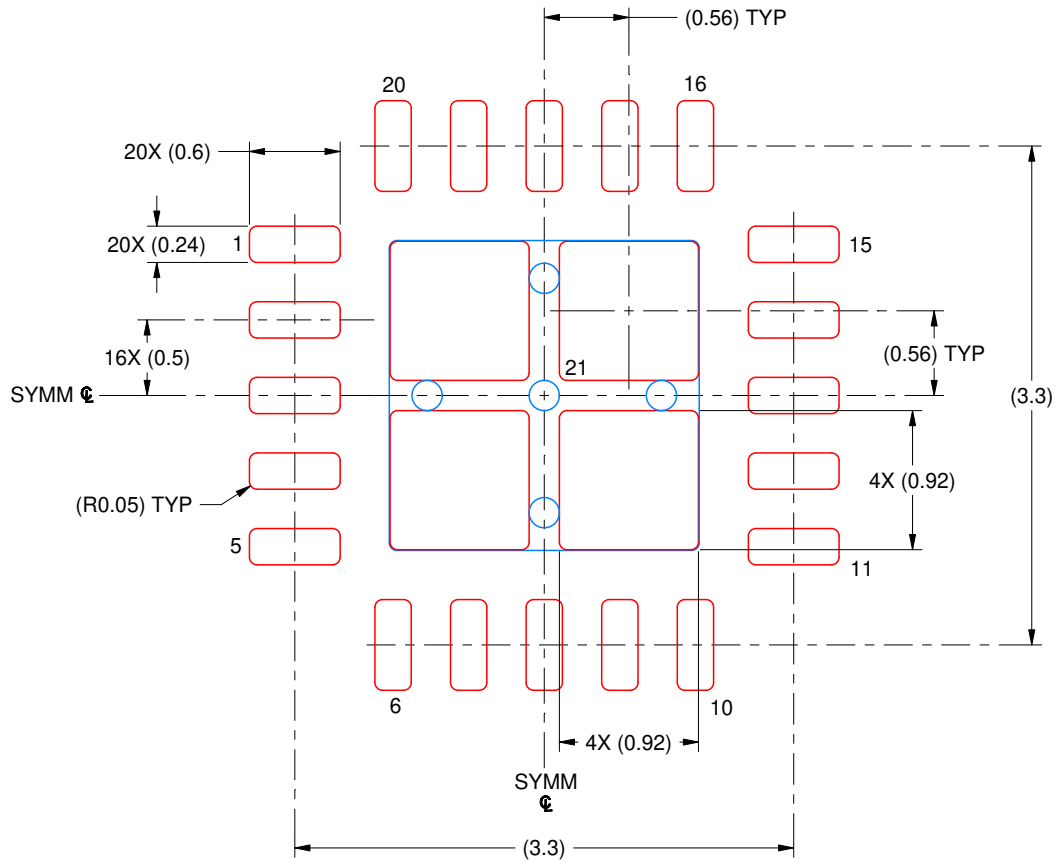

SOLDER PASTE EXAMPLE
BASED ON 0.125 MM THICK STENCIL
SCALE: 20X

EXPOSED PAD 21
81% PRINTED SOLDER COVERAGE BY AREA UNDER PACKAGE

4219031/B 04/2022

NOTES: (continued)

6. Laser cutting apertures with trapezoidal walls and rounded corners may offer better paste release. IPC-7525 may have alternate design recommendations.

IMPORTANT NOTICE AND DISCLAIMER

TI PROVIDES TECHNICAL AND RELIABILITY DATA (INCLUDING DATA SHEETS), DESIGN RESOURCES (INCLUDING REFERENCE DESIGNS), APPLICATION OR OTHER DESIGN ADVICE, WEB TOOLS, SAFETY INFORMATION, AND OTHER RESOURCES "AS IS" AND WITH ALL FAULTS, AND DISCLAIMS ALL WARRANTIES, EXPRESS AND IMPLIED, INCLUDING WITHOUT LIMITATION ANY IMPLIED WARRANTIES OF MERCHANTABILITY, FITNESS FOR A PARTICULAR PURPOSE OR NON-INFRINGEMENT OF THIRD PARTY INTELLECTUAL PROPERTY RIGHTS.

These resources are intended for skilled developers designing with TI products. You are solely responsible for (1) selecting the appropriate TI products for your application, (2) designing, validating and testing your application, and (3) ensuring your application meets applicable standards, and any other safety, security, regulatory or other requirements.

These resources are subject to change without notice. TI grants you permission to use these resources only for development of an application that uses the TI products described in the resource. Other reproduction and display of these resources is prohibited. No license is granted to any other TI intellectual property right or to any third party intellectual property right. TI disclaims responsibility for, and you will fully indemnify TI and its representatives against, any claims, damages, costs, losses, and liabilities arising out of your use of these resources.

TI's products are provided subject to [TI's Terms of Sale](#) or other applicable terms available either on [ti.com](https://www.ti.com) or provided in conjunction with such TI products. TI's provision of these resources does not expand or otherwise alter TI's applicable warranties or warranty disclaimers for TI products.

TI objects to and rejects any additional or different terms you may have proposed.

Mailing Address: Texas Instruments, Post Office Box 655303, Dallas, Texas 75265
Copyright © 2023, Texas Instruments Incorporated