

## SMT GaAs HBT MMIC x16 ACTIVE FREQUENCY MULTIPLIER, 9.9 - 11.0 GHz OUTPUT



### Typical Applications

Active Multiplier for X Band Applications:

- Fiber Optic
- Point-to-Point Radios
- Military Radar

### Features

- Output Power: +7 dBm
- Sub-Harmonic Suppression: >25 dBc
- SSB Phase Noise: -130 dBc/Hz
- Single Supply: 5V @ 78 mA
- 24 Lead 4x4 mm SMT Package: 16 mm<sup>2</sup>

### Functional Diagram

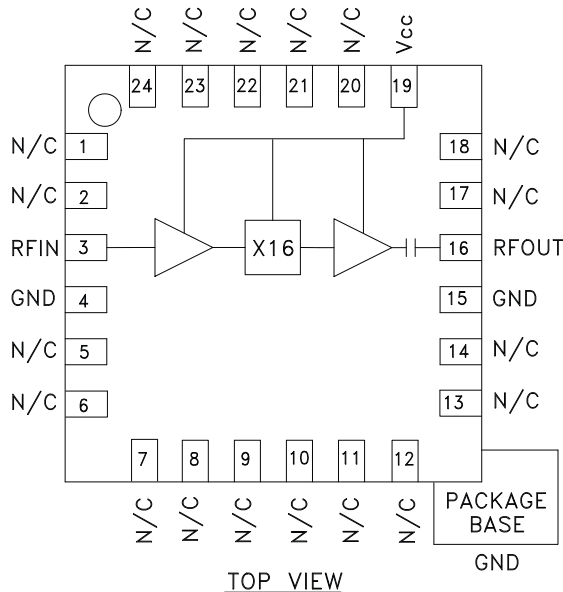

### General Description

The HMC445LP4 & HMC445LP4E are active miniature x16 frequency multipliers utilizing InGaP GaAs HBT technology in 4x4 mm leadless surface mount packages. Power output is +7 dBm typical from a 5V supply voltage and varies little vs. input power, temperature and supply voltage. Suppression of undesired fundamental and sub-harmonics is >25 dBc typical with respect to output signal level. The low additive SSB phase noise of -130 dBc/Hz at 100 kHz offset helps the user maintain good system noise performance. The HMC445LP4 & HMC445LP4E are ideal for use in LO multiplier chains allowing reduced parts count vs. traditional approaches.

### Electrical Specifications, $T_A = +25^\circ\text{C}$ , $V_{CC} = 5\text{V}$

Parameter	Min.	Typ.	Max.	Units
Frequency Range, Input	618.75 - 687.50			MHz
Frequency Range, Output	9.9 - 11.0			GHz
Input Power Range	-15		5	dBm
Output Power	4	7		dBm
Sub-Harmonic Suppression		25		dBc
Input Return Loss		28		dB
Output Return Loss		7		dB
SSB Phase Noise (100 kHz Offset)	Pin= 0 dBm		-130	dBc/Hz
Supply Current (I <sub>CC</sub> )		78	104	mA

**SMT GaAs HBT MMIC x16 ACTIVE  
FREQUENCY MULTIPLIER, 9.9 - 11.0 GHz OUTPUT**



**Output Power vs. Temperature @ -10 dBm Drive Level**

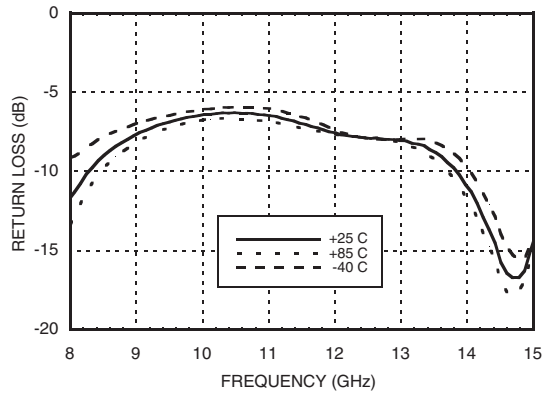

**Output Power vs. Drive Level**

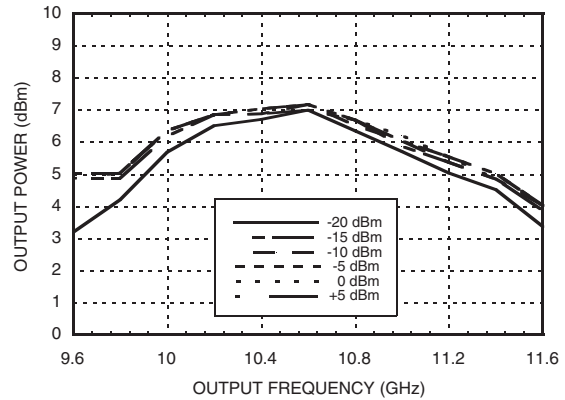

**Output Power vs. Supply Voltage @ -10 dBm Drive Level**

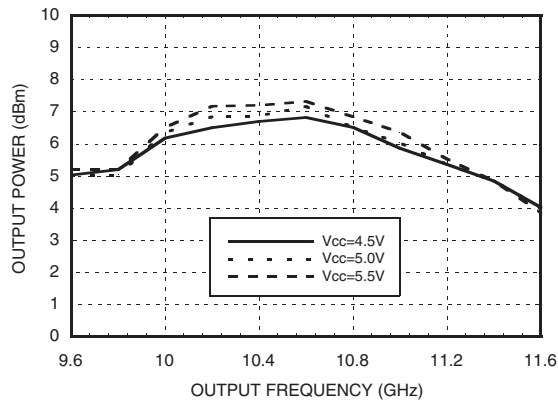

**Input Return Loss vs. Temperature**

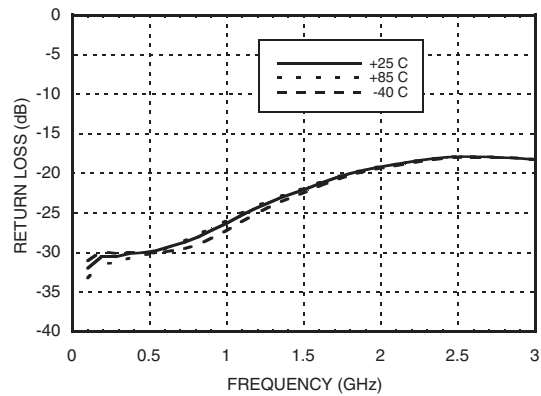

**Output Return Loss vs. Temperature**

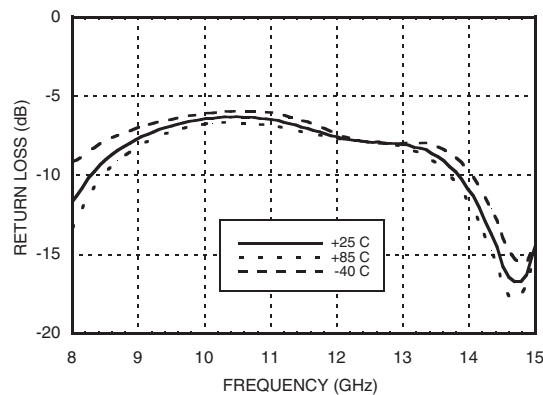

Information furnished by Analog Devices is believed to be accurate and reliable. However, no responsibility is assumed by Analog Devices for its use, nor for any infringements of patents or other rights of third parties that may result from its use. Specifications subject to change without notice. No license is granted by implication or otherwise under any patent or patent rights of Analog Devices. Trademarks and registered trademarks are the property of their respective owners.

For price, delivery, and to place orders: Analog Devices, Inc., One Technology Way, P.O. Box 9106, Norwood, MA 02062-9106 Phone: 781-329-4700 • Order online at [www.analog.com](http://www.analog.com) Application Support: Phone: 1-800-ANALOG-D

**SMT GaAs HBT MMIC x16 ACTIVE  
FREQUENCY MULTIPLIER, 9.9 - 11.0 GHz OUTPUT**



**Output Spectrum**

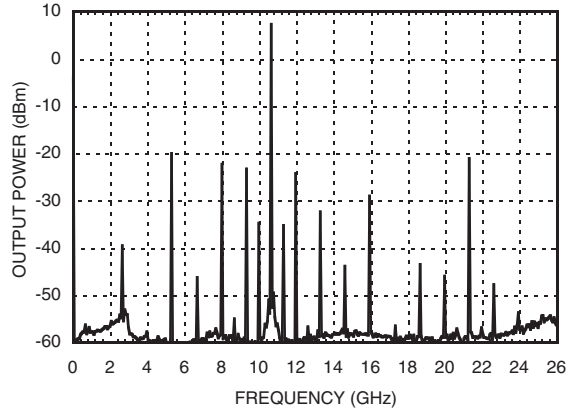

**SSB Phase Noise  
Performance,  $F_{out} = 10.5$  GHz**

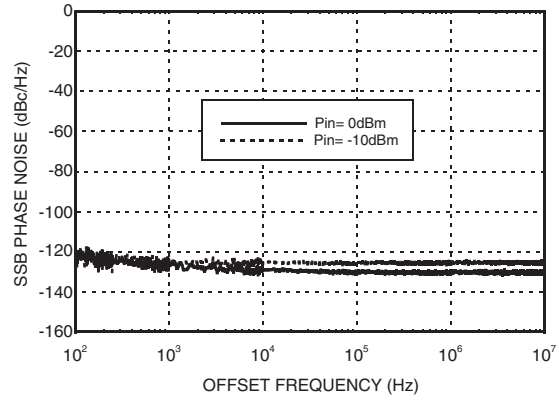

Information furnished by Analog Devices is believed to be accurate and reliable. However, no responsibility is assumed by Analog Devices for its use, nor for any infringements of patents or other rights of third parties that may result from its use. Specifications subject to change without notice. No license is granted by implication or otherwise under any patent or patent rights of Analog Devices. Trademarks and registered trademarks are the property of their respective owners.

For price, delivery, and to place orders: Analog Devices, Inc., One Technology Way, P.O. Box 9106, Norwood, MA 02062-9106 Phone: 781-329-4700 • Order online at [www.analog.com](http://www.analog.com) Application Support: Phone: 1-800-ANALOG-D

## SMT GaAs HBT MMIC x16 ACTIVE FREQUENCY MULTIPLIER, 9.9 - 11.0 GHz OUTPUT



### Absolute Maximum Ratings

RF Input (Vcc = +5V)	+20 dBm
Vcc	+5.5V
Channel Temperature	135 °C
Continuous Pdiss (T=85 °C) (derate 11.5 mW/°C above 85 °C)	750 mW
Thermal Resistance (R <sub>thj</sub> ) (junction to ground paddle)	87.2 °C/W
Storage Temperature	-65 to +150 °C
Operating Temperature	-40 to +85 °C

### Typical Supply Current vs. Vcc

Vcc (V)	Icc (mA)
4.5	75
5.0	78
5.5	80

Note: Multiplier will operate over full voltage range shown above.



ELECTROSTATIC SENSITIVE DEVICE  
OBSERVE HANDLING PRECAUTIONS

5

### Outline Drawing

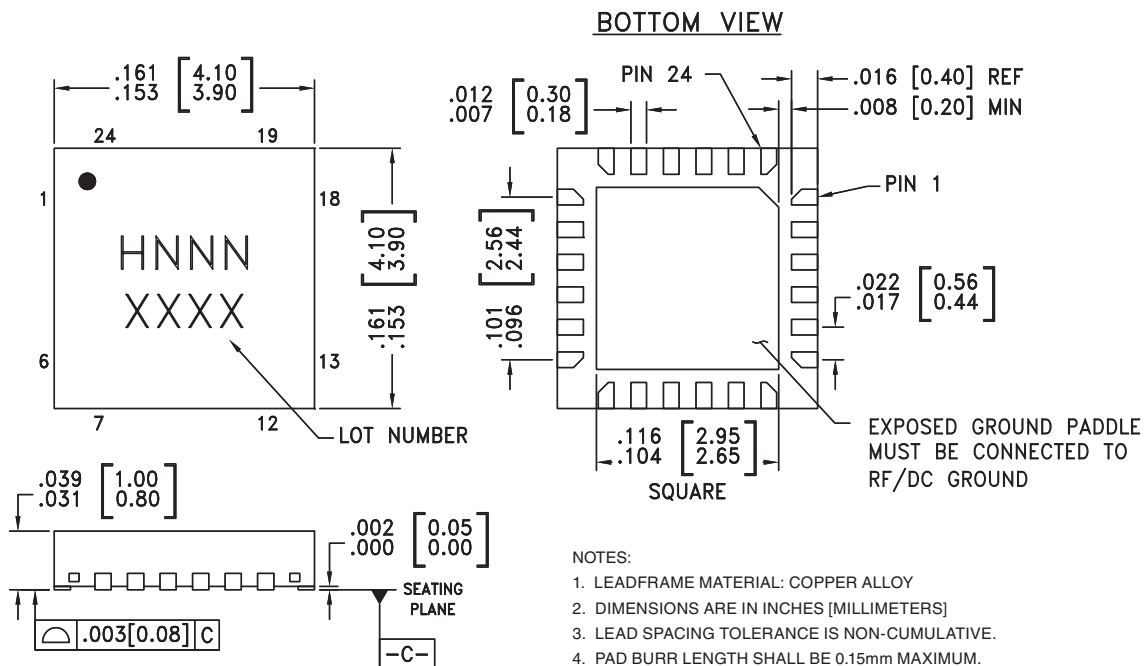

### Package Information



Part Number	Package Body Material	Lead Finish	MSL Rating	Package Marking <sup>[3]</sup>
HMC445LP4	Low Stress Injection Molded Plastic	Sn/Pb Solder	MSL1 <sup>[1]</sup>	H445 XXXX
HMC445LP4E	RoHS-compliant Low Stress Injection Molded Plastic	100% matte Sn	MSL1 <sup>[2]</sup>	H445 XXXX

[1] Max peak reflow temperature of 235 °C

[2] Max peak reflow temperature of 260 °C

[3] 4-Digit lot number XXXX

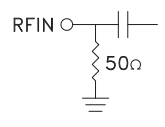

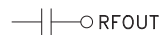
**SMT GaAs HBT MMIC x16 ACTIVE  
FREQUENCY MULTIPLIER, 9.9 - 11.0 GHz OUTPUT**
**Pin Description**

Pin Number	Function	Description	Interface Schematic
1, 2, 5 - 14, 17, 18, 20 - 24	N/C	The pins are not connected internally; however, all data shown herein was measured with these pins connected to RF/DC ground externally.	
3	RFIN	RF input needs to be DC blocked only if there is an external DC voltage applied to RF IN.	
4, 15	GND	All ground leads and ground paddle must be soldered to PCB RF/DC ground.	
16	RFOUT	Multiplied Output. AC coupled. No external DC blocks necessary.	
19	Vcc	Supply voltage 5V ± 0.5V.	

## SMT GaAs HBT MMIC x16 ACTIVE FREQUENCY MULTIPLIER, 9.9 - 11.0 GHz OUTPUT

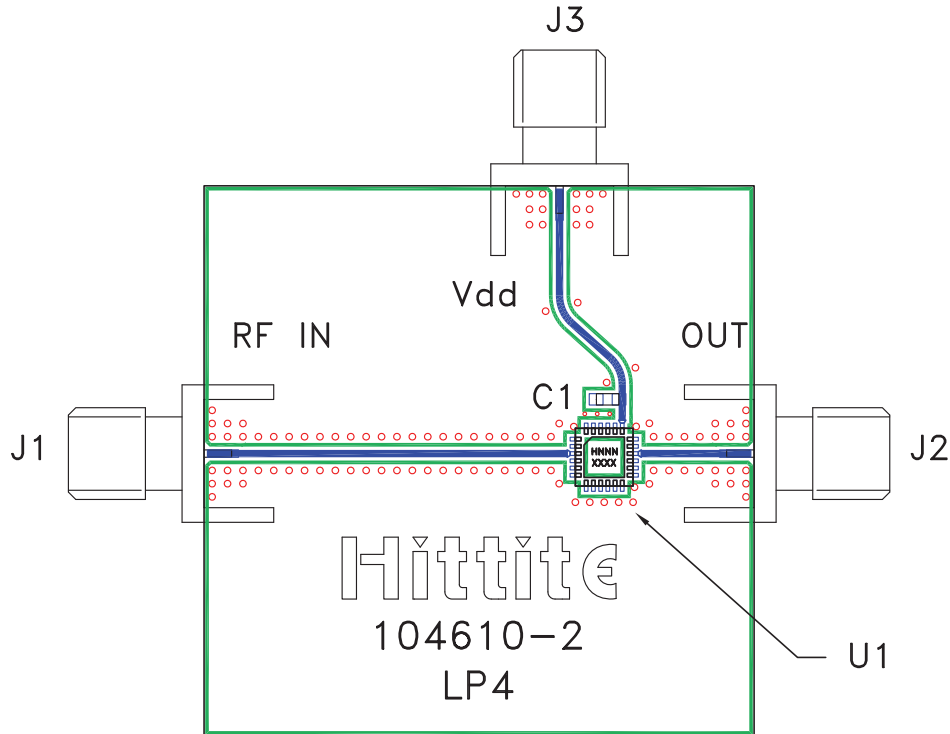

### Evaluation PCB



### List of Materials for Evaluation PCB 106137 [1]

Item	Description
J1 - J3	PCB Mount SMA Connector
C1	1,000 pF Capacitor, 0603 Pkg.
U1	HMC445LP4 / HMC445LP4E x16 Active Multiplier
PCB [2]	104610 Eval Board

[1] Reference this number when ordering complete evaluation PCB

[2] Circuit Board Material: Rogers 4350

The circuit board used in the final application should be generated with proper RF circuit design techniques. Signal lines should have 50 ohm impedance while the package ground leads and exposed paddle should be connected directly to the ground plane similar to that shown. The evaluation circuit board shown is available from Hittite upon request.