

Evaluating the **AD5600** High Temperature, 16-Bit, Unbuffered Voltage Output DAC, SPI Interface

FEATURES

Full featured evaluation board for the [AD5600](#)
On-board references
Various link options
PC control in conjunction with the Analog Devices, Inc., [SDP](#)

EVALUATION KIT CONTENTS

EVAL-AD5600PMDZ
[SDP-PMD-IB1Z](#)

HARDWARE REQUIRED

[EVAL-SDP-CB1Z \(SDP-B\)](#) board, must be purchased separately

SOFTWARE REQUIRED

[Analysis, control, evaluation \(ACE\) software](#), available for download from the [EVAL-AD5600PMDZ product page](#)

GENERAL DESCRIPTION

This user guide details the operation of the EVAL-AD5600PMDZ for the [AD5600](#) voltage output, digital-to-analog converter (DAC).

The EVAL-AD5600PMDZ is designed to help users quickly prototype [AD5600](#) circuits and reduce design time. The [AD5600](#) operates from a single 2.7 V to 5.5 V supply. The EVAL-AD5600PMDZ also incorporates high temperature [ADR225](#) voltage reference and [AD8634](#) buffer.

The EVAL-AD5600PMDZ interfaces to the USB port of a PC via a system demonstration platform ([SDP](#)) board and the [SDP-PMD-IB1Z](#) board. The [ACE](#) software is available for download from the EVAL-AD5600PMDZ product page to use with the evaluation board to allow the user to program the [AD5600](#). A peripheral module (PMOD) connection is also available to allow the connection of microcontrollers to the evaluation board without the [SDP](#) board. Note that when a microcontroller is used through the PMOD connection, the [SDP](#) board must be disconnected, and the user is unable to operate the [ACE](#) software.

The EVAL-AD5600PMDZ is compatible with any Analog Devices [SDP](#) board, which can be purchased separately. A typical connection between the EVAL-AD5600PMDZ, the [EVAL-SDP-CB1Z](#) board ([SDP-B](#) controller board), and the [SDP-PMD-IB1Z](#) is shown in Figure 1.

For full details, see the [AD5600](#) data sheet, which must be used in conjunction with this user guide when using the EVAL-AD5600PMDZ.

EVAL-AD5600PMDZ CONNECTED TO THE [SDP-B](#) BOARD AND [SDP-PMD-IB1Z](#) BOARD

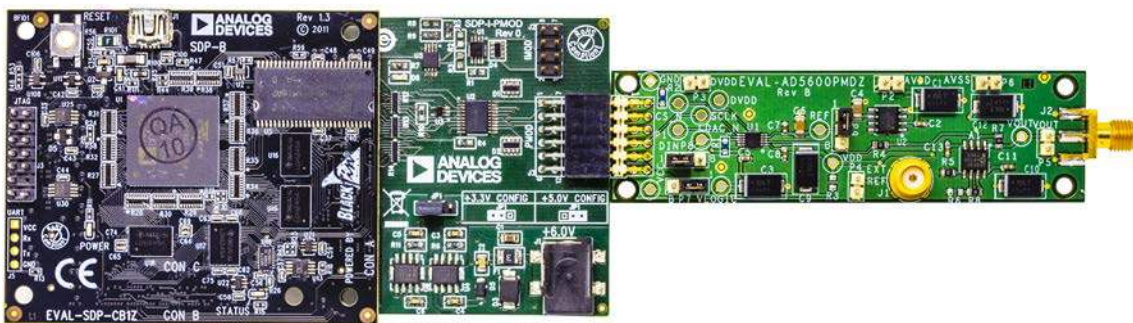

Figure 1.

20797-001

TABLE OF CONTENTS

Features	1	Block Diagram and Description.....	4
Evaluation Kit Contents.....	1	Evaluation Board Hardware.....	5
Hardware Required	1	Power Supplies.....	5
Software Required	1	Test Points	5
General Description	1	Voltage References.....	5
EVAL-AD5600PMDZ Connected to the SDP-B Board and SDP- PMD-IB1Z Board	1	Link Options	5
Revision History	2	Evaluation Board Schematics and Artwork.....	6
Evaluation Board Software Quick Start Procedures	3	Ordering Information.....	8
Installing the Software	3	Bill of Materials.....	8
Initial Setup	3		

REVISION HISTORY

10/2019—Revision 0: Initial Version

EVALUATION BOARD SOFTWARE QUICK START PROCEDURES

INSTALLING THE SOFTWARE

The EVAL-AD5600PMDZ uses the [ACE](#) evaluation software, a desktop software application that allows the evaluation and control of multiple evaluation systems.

The [ACE](#) installer installs the necessary [SDP](#) drivers and the Microsoft® .NET Framework 4 by default. The [ACE](#) software is available for download from the EVAL-AD5600PMDZ product page, and must be installed before connecting the [SDP](#) board to the USB port of the PC to ensure that the [SDP](#) board is recognized when it connects to the PC. For full instructions on how to install and use this software, see the [ACE](#) software page on the Analog Devices website.

After the installation is finished, the EVAL-AD5600PMDZ icon appears when the [ACE](#) software is opened.

INITIAL SETUP

To set up the EVAL-AD5600PMDZ, take the following steps:

1. Connect the evaluation boards as shown in Figure 1, and then connect the USB cable between the [SDP-B](#) board and the PC.
2. Run the [ACE](#) application. The EVAL-AD5600PMDZ icon appear in the attached hardware pane of the **Start** tab.
3. Double click the board icon to open the board view shown in Figure 2.
4. Double click the **AD5600** icon in Figure 2 to access the chip block diagram. This view provides a basic representation of the functionality of the board. The main function blocks of the board are labeled in Figure 3.

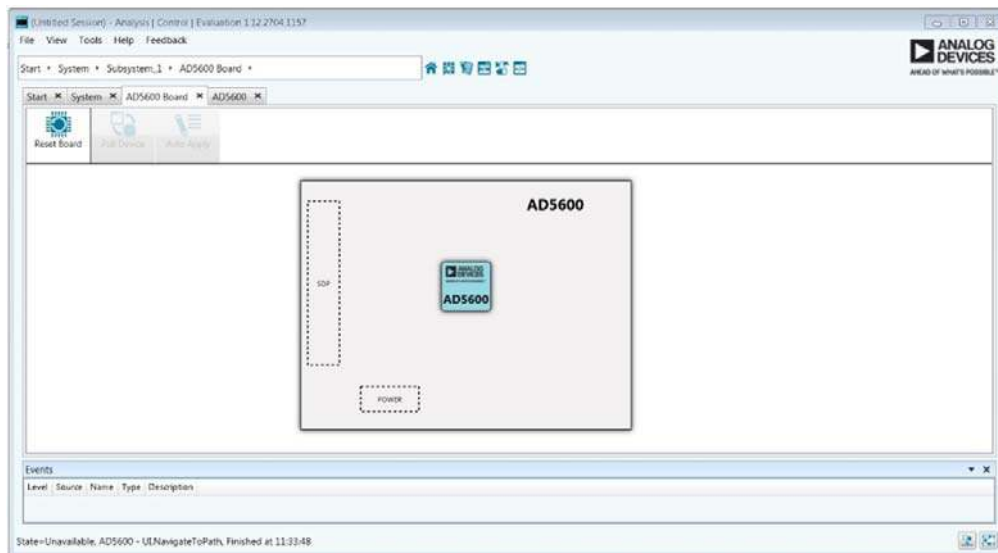

Figure 2. Board View of the EVAL-AD5600PMDZ

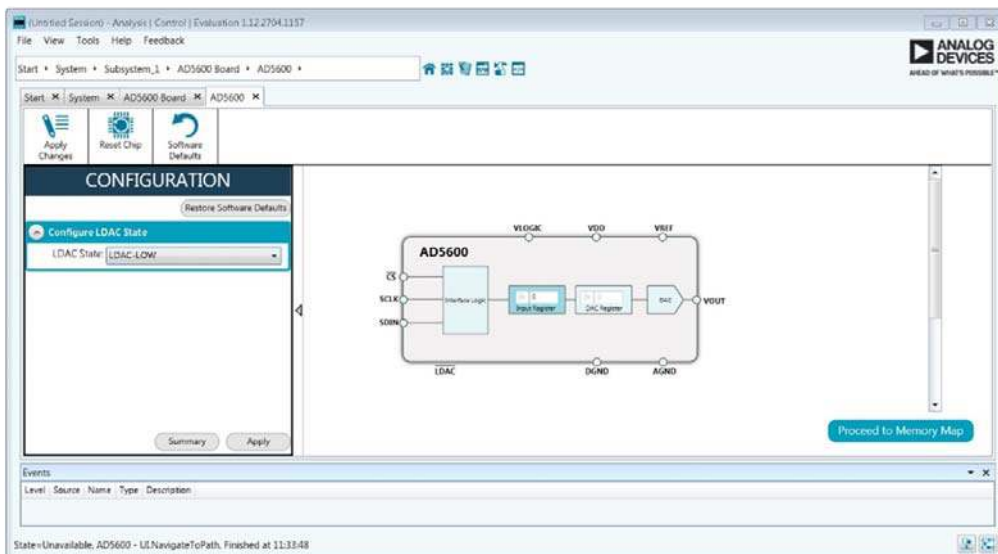

Figure 3. Chip Block Diagram of the AD5600

BLOCK DIAGRAM AND DESCRIPTION

The EVAL-AD5600PMDZ software is organized to appear similar to the functional block diagram shown in the [AD5600](#) data sheet. Therefore, correlating the functions on the EVAL-AD5600PMDZ with the descriptions in the [AD5600](#) data sheet is simplified.

For a full description of each block, register, and its settings, see the [AD5600](#) data sheet.

Some of the blocks and their functions are described in this section as they pertain to the evaluation board. The block diagram is shown in Figure 4. Table 1 describes the functionality of each block.

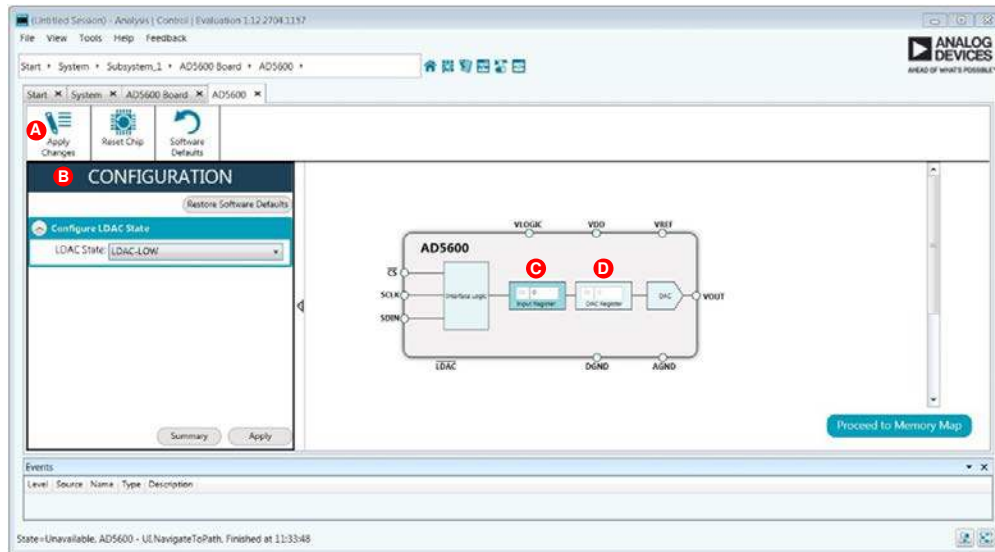

Figure 4. [AD5600](#) Block Diagram with Labels

Table 1. Block Diagram Functions (See Figure 4 for Labels)

Label	Button/Function Name	Function
A	Apply Changes	Applies all modified values to the device. Note that if an evaluation board is not connected, values entered into the input registers are not transferred to the DAC registers.
B	CONFIGURATION Wizard	Used to set the initial configuration for the EVAL-AD5600PMDZ. Select the LDAC pin configuration from the LDAC State dropdown box. A gain of 1 is the default. After setting up the initial configuration, click Apply to apply the values. These settings can be modified at any stage while evaluating the EVAL-AD5600PMDZ.
C	Input Register	16-bit data word to be transferred to the device. Click Apply Changes (Label A) to transfer this 16-bit dataword to the device.
D	DAC Register	Displays the value that is currently present in the DAC register on the device. Update the DAC registers by selecting LDAC-LOW from the LDAC State dropdown box.

EVALUATION BOARD HARDWARE

POWER SUPPLIES

The EVAL-AD5600PMDZ requires an external source for the analog and digital supply. See Table 2 for more details.

Both AGND and DGND inputs are provided on the EVAL-AD5600PMDZ. The AGND and DGND planes are connected at one location close to the AD5600. To avoid ground loop problems, it is recommended that AGND and DGND not be connected elsewhere in the system.

All supplies are decoupled to ground with 10 μ F tantalum and 0.1 μ F ceramic capacitors.

TEST POINTS

The EVAL-AD5600PMDZ has various test points for debugging and monitoring purposes. These test points are described in Table 3.

VOLTAGE REFERENCES

The EVAL-AD5600PMDZ has an on-board voltage reference with a value of 2.5 V. Note that the ADR225 requires the use of an external supply through the AVDD connector (see Table 2).

LINK OPTIONS

A number of link options are incorporated on the EVAL-AD5600PMDZ and must be set for the required operating conditions before using the board. The functions of these link options are described in Table 4.

Table 2. Power Supply Connectors

Connector No.	Label	External Voltage Supplies Description
P2-1	AVDD	Positive analog supply. Connect 5.0 V to this terminal.
P6-1	AVSS	Negative analog supply. Connect -5.0 V to this terminal.
P2-2, P6-2	AGND	Analog ground.
P3-1	DVDD	Digital supply. Connect 5.0 V to this terminal.
P3-2	DGND	Digital ground.

Table 3. Test Point Descriptions¹

Test Point	Description
GND	Board ground.
VCC	PMOD digital supply.
DVDD	External digital supply.
VLOGIC	IOVDD digital supply.
VDD	VDD analog supply.
CS_N	Chip select.
DIN	Serial data input signal.
SCLK	Serial clock input signal.
LDAC_N	LDAC input signal.
VOUT	Buffered DAC output voltage.

¹ These test points are not populated on the evaluation board, but the user can use the copper pads to solder the test points.

Table 4. Link Options Setup for SDP Control

Link	Position	Description
P7	A (default)	VLOGIC test point is connected to DVDD.
	B	VLOGIC test point is connected to the VCC test point on PMOD.
P8	A (default)	LDAC is connected to PMOD.
	B	LDAC is connected to ground.
P9	A (default)	VREF is connected to ADR225 output.
	B	VREF is connected to J1. Connect an external reference voltage to J1.

EVALUATION BOARD SCHEMATICS AND ARTWORK

20797.005

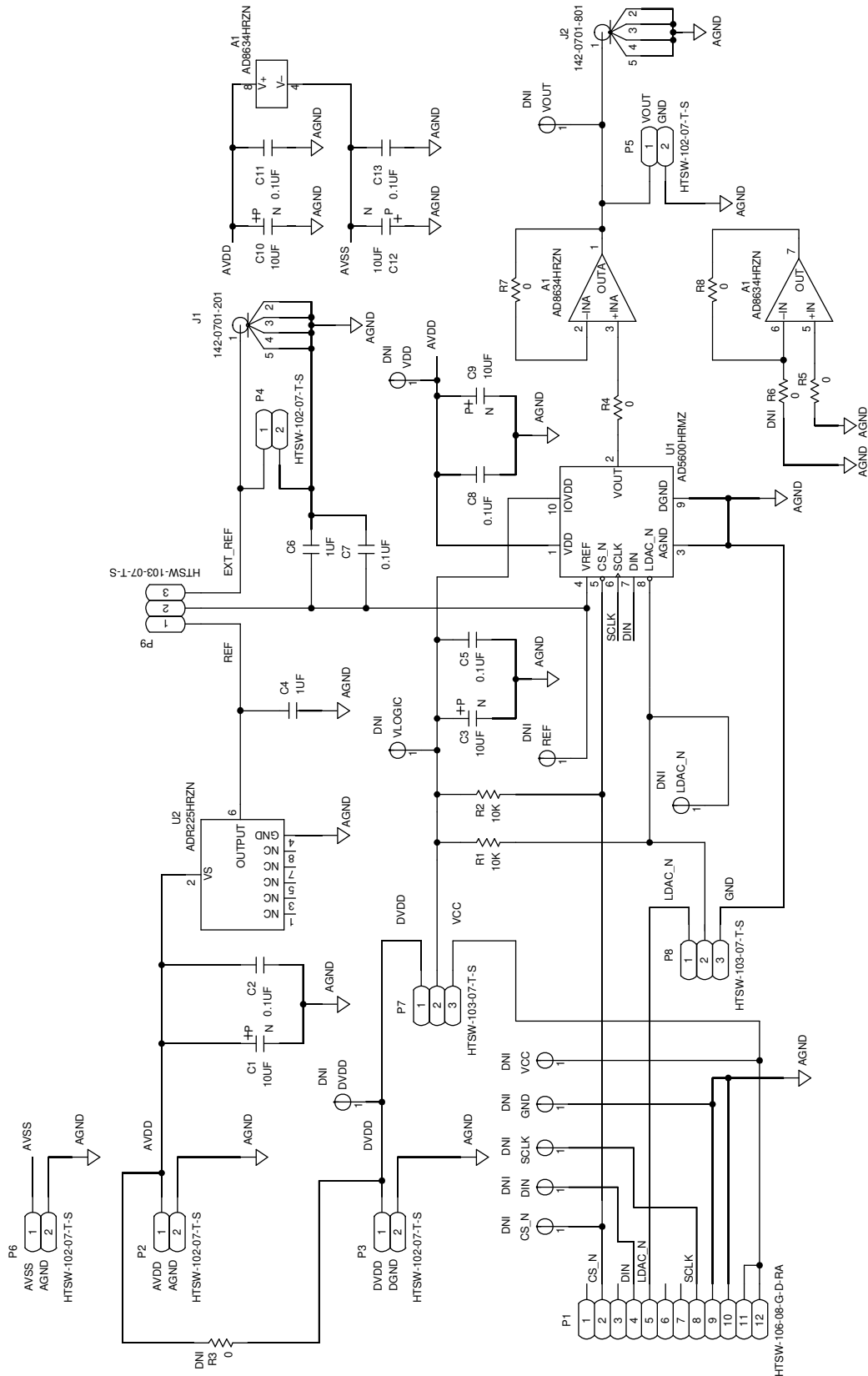

Figure 5. EVAL-AD5600PMDZ Schematic: Power Supply and Signal Routes

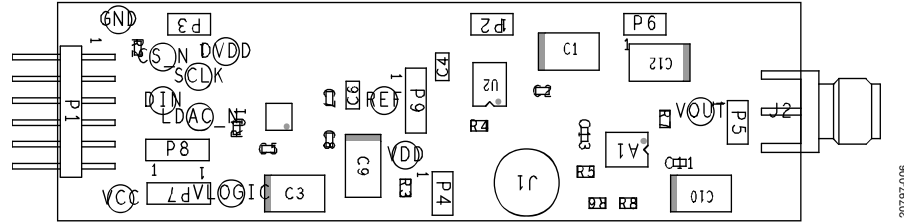

Figure 6. EVAL-AD5600PMDZ Component Placement

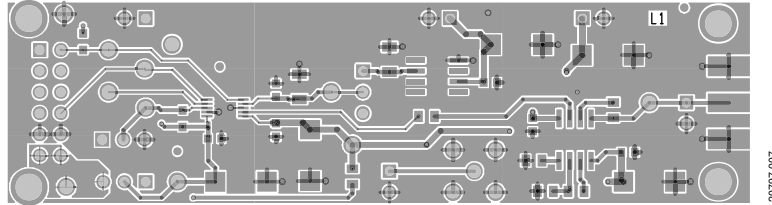

Figure 7. EVAL-AD5600PMDZ Top Side Routing

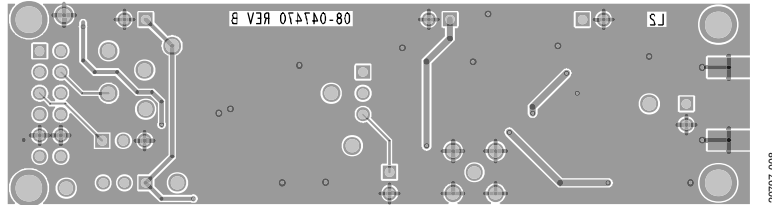

Figure 8. EVAL-AD5600PMDZ Bottom Side Routing

ORDERING INFORMATION

BILL OF MATERIALS

Table 5.

Qty	Reference Designator	Description	Supplier/Part Number	Manufacturing Part Number
5	C1, C3, C9, C10, C12	Capacitors, 10 μ F, 50 V	AVX	THJD106K050RJN
6	C2, C5, C7, C8, C11, C13	Capacitors, 0.1 μ F, 25 V, 0603	KEMET	C0603C104K3RACTU
2	C4, C6	Capacitors, 1 μ F, 25 V, 1206	KEMET	C1206R105K3RAC7800
1	J1	Surface-mount type A (SMA) connector straight	CINCH Connectivity Solutions	142-0701-201
1	J2	SMA connector end launch	CINCH Connectivity Solutions	142-0701-801
1	P1	12-pin PMOD connector	SAMTEC	HTSW-106-08-G-D-RA
5	P2, P3, P4, P5, P6	2-pin header, 1 position link/jumper	SAMTEC Inc.	HTSW-102-07-T-S
3	P7, P8, P9	3-pin header, 2 position link/jumper	SAMTEC Inc.	HTSW-103-07-T-S
2	R1, R2	Resistors, 10 k Ω , 1%, 1/8W, 0603	Vishay	CHPHT0603K1002FGT
4	R4, R5, R7, R8	Resistors, 0 Ω , 1%, 1/8W, 0805	Panasonic	ERJ-6GEY0R00V
2	R3, R6	Resistors, 0 Ω , 1%, 1/8W, 0805	Panasonic	Not Inserted
1	U1	High temperature, 16-bit, unbuffered voltage output DAC	Analog Devices	AD5600HRMZ
1	U2	High temperature, low drift, micropower 2.5 V reference	Analog Devices	ADR225HRZN
1	A1	High temperature, low power op amp	Analog Devices	AD8634HRZN

**ESD Caution**

ESD (electrostatic discharge) sensitive device. Charged devices and circuit boards can discharge without detection. Although this product features patented or proprietary protection circuitry, damage may occur on devices subjected to high energy ESD. Therefore, proper ESD precautions should be taken to avoid performance degradation or loss of functionality.

Legal Terms and Conditions

By using the evaluation board discussed herein (together with any tools, components documentation or support materials, the "Evaluation Board"), you are agreeing to be bound by the terms and conditions set forth below ("Agreement") unless you have purchased the Evaluation Board, in which case the Analog Devices Standard Terms and Conditions of Sale shall govern. Do not use the Evaluation Board until you have read and agreed to the Agreement. Your use of the Evaluation Board shall signify your acceptance of the Agreement. This Agreement is made by and between you ("Customer") and Analog Devices, Inc. ("ADI"), with its principal place of business at One Technology Way, Norwood, MA 02062, USA. Subject to the terms and conditions of the Agreement, ADI hereby grants to Customer a free, limited, personal, temporary, non-exclusive, non-sublicensable, non-transferable license to use the Evaluation Board FOR EVALUATION PURPOSES ONLY. Customer understands and agrees that the Evaluation Board is provided for the sole and exclusive purpose referenced above, and agrees not to use the Evaluation Board for any other purpose. Furthermore, the license granted is expressly made subject to the following additional limitations: Customer shall not (i) rent, lease, display, sell, transfer, assign, sublicense, or distribute the Evaluation Board; and (ii) permit any Third Party to access the Evaluation Board. As used herein, the term "Third Party" includes any entity other than ADI, Customer, their employees, affiliates and in-house consultants. The Evaluation Board is NOT sold to Customer; all rights not expressly granted herein, including ownership of the Evaluation Board, are reserved by ADI. CONFIDENTIALITY. This Agreement and the Evaluation Board shall all be considered the confidential and proprietary information of ADI. Customer may not disclose or transfer any portion of the Evaluation Board to any other party for any reason. Upon discontinuation of use of the Evaluation Board or termination of this Agreement, Customer agrees to promptly return the Evaluation Board to ADI. ADDITIONAL RESTRICTIONS. Customer may not disassemble, decompile or reverse engineer chips on the Evaluation Board. Customer shall inform ADI of any occurred damages or any modifications or alterations it makes to the Evaluation Board, including but not limited to soldering or any other activity that affects the material content of the Evaluation Board. Modifications to the Evaluation Board must comply with applicable law, including but not limited to the RoHS Directive. TERMINATION. ADI may terminate this Agreement at any time upon giving written notice to Customer. Customer agrees to return to ADI the Evaluation Board at that time. LIMITATION OF LIABILITY. THE EVALUATION BOARD PROVIDED HEREUNDER IS PROVIDED "AS IS" AND ADI MAKES NO WARRANTIES OR REPRESENTATIONS OF ANY KIND WITH RESPECT TO IT. ADI SPECIFICALLY DISCLAIMS ANY REPRESENTATIONS, ENDORSEMENTS, GUARANTEES, OR WARRANTIES, EXPRESS OR IMPLIED, RELATED TO THE EVALUATION BOARD INCLUDING, BUT NOT LIMITED TO, THE IMPLIED WARRANTY OF MERCHANTABILITY, TITLE, FITNESS FOR A PARTICULAR PURPOSE OR NON-INFRINGEMENT OF INTELLECTUAL PROPERTY RIGHTS. IN NO EVENT WILL ADI AND ITS LICENSORS BE LIABLE FOR ANY INCIDENTAL, SPECIAL, INDIRECT, OR CONSEQUENTIAL DAMAGES RESULTING FROM CUSTOMER'S POSSESSION OR USE OF THE EVALUATION BOARD, INCLUDING BUT NOT LIMITED TO LOST PROFITS, DELAY COSTS, LABOR COSTS OR LOSS OF GOODWILL. ADI'S TOTAL LIABILITY FROM ANY AND ALL CAUSES SHALL BE LIMITED TO THE AMOUNT OF ONE HUNDRED US DOLLARS (\$100.00). EXPORT. Customer agrees that it will not directly or indirectly export the Evaluation Board to another country, and that it will comply with all applicable United States federal laws and regulations relating to exports. GOVERNING LAW. This Agreement shall be governed by and construed in accordance with the substantive laws of the Commonwealth of Massachusetts (excluding conflict of law rules). Any legal action regarding this Agreement will be heard in the state or federal courts having jurisdiction in Suffolk County, Massachusetts, and Customer hereby submits to the personal jurisdiction and venue of such courts. The United Nations Convention on Contracts for the International Sale of Goods shall not apply to this Agreement and is expressly disclaimed.