



Crystal Clock Oscillator Specification

IQD Part No. + Packaging: LFSPX0018871Reel

Würth Part No. 831018871



Description

- Standard 7 x 5mm crystal oscillator in a ceramic package with a seam sealed metal lid, hermetically sealed.
- Model CFPS-72
- Model Issue number 13

Frequency Parameters

- Frequency 48.0MHz
- Frequency Stability ± 100.00 ppm
- Operating Temperature Range -40.00 to 85.00°C
- Ageing ± 3 ppm per year max

Electrical Parameters

- Supply Voltage $5.0\text{V} \pm 10\%$
- Current Draw 50.000mA
- Note: parameters are referenced to 15pF load

Output Details

- Output Compatibility HCMOS/TTL
- Drive Capability 15pF std, 50pF max
- Rise and Fall Time 6.0ns max
- Duty Cycle 45/55%

Output Control

- Standby Operation:
Logic '1' ($>70\%$ Vs) to pad 1 enables oscillator output.
Logic '0' ($<30\%$ Vs) to pad 1 disables oscillator output; the oscillator output goes to the high impedance state.
No connection to pad 1 enables oscillator output.
Standby Current: $10\mu\text{A}$ max

Noise Parameters

- RMS Phase Jitter: 350fs typical

Environmental Parameters

- Shock: MIL-STD-202, Method 213, Condition E.
- Vibration: MIL-STD-883, Method 2007, Condition A.
- Storage Temperature Range: -55 to 125°

Manufacturing Details

- RoHS Terminations NiAu
- RoHS Reflow Temp 260degC 10s

Compliance

- RoHS Status (2011/65/EU) Compliant
- REACH Status Compliant
- MSL Rating (JDEC-STD-033): Not Applicable

Packaging Details

- Pack Style: Reel Tape & reel in accordance with EIA-481-D
- Pack Size: 1,000



Outline (mm)

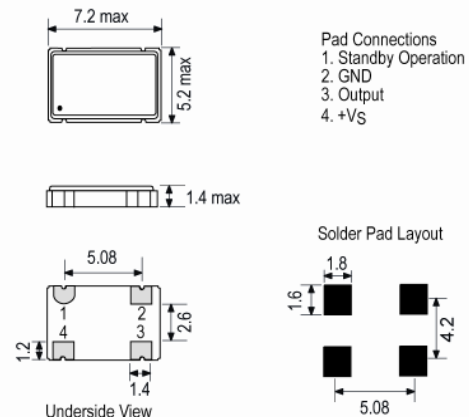

Test Circuit

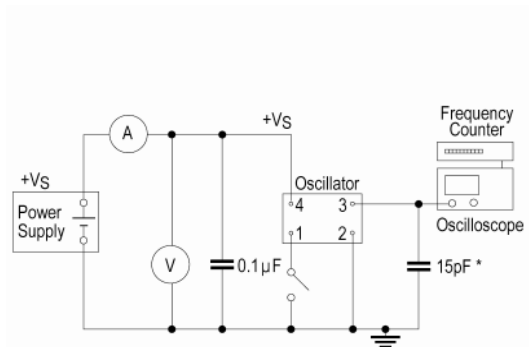

* Inclusive of jigging and equipment capacitance

CONTACT INFORMATION:

Würth Elektronik eiSos GmbH & Co. KG
Max-Eyth-Str. 1, 74638 Waldenburg, Germany
Tel: +49(0) 7942 945-0

Email: eiSos@we-online.de
Web: www.we-online.com



Crystal Clock Oscillator Specification

IQD Part No. + Packaging: LFSPX0018871Reel

Würth Part No. 831018871



- Alternative packing option available

USEFUL LINKS

Toolbox:

www.we-online.com/toolbox

Product Catalog:

www.we-online.com/products

Wave Form

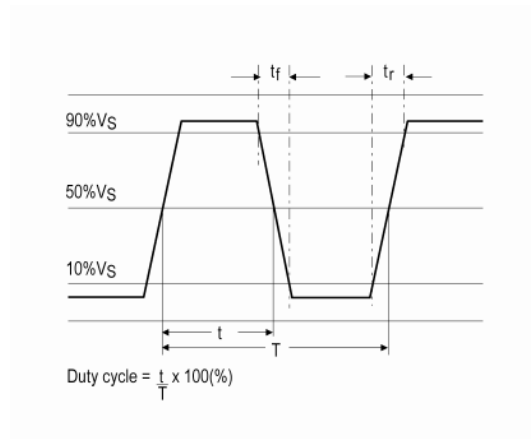

CONTACT INFORMATION:

Würth Elektronik eiSos GmbH & Co. KG
Max-Eyth-Str. 1, 74638 Waldenburg, Germany
Tel: +49(0) 7942 945-0

Email: eiSos@we-online.de
Web: www.we-online.com