

NOTES:

1. ROHS COMPLIANT
2. HEADER: PHENOLIC WITH FLAMMABILITY RATING UL 94V-0 OR BETTER.
3. STORAGE TEMPERATURE: -50°C TO +125°C
4. COMPLIANCE TO J-STD:
 - A. J-STD-002: SOLDERABILITY AT 245°C REFLOW PROFILE
 - B. J-STD-020: LEVEL 1, NO MOISTURE SENSITIVE
 - C. J-STD-075: R7, 245°C MAXIMUM THROUGH REFLOW SOLDER
5. TO ORDER TAPE & REEL PACKAGING ADD A "T" SUFFIX TO THE PART NUMBER(i.e TX1544FNL BECOMES TX1544FNLT).

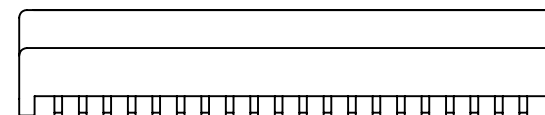
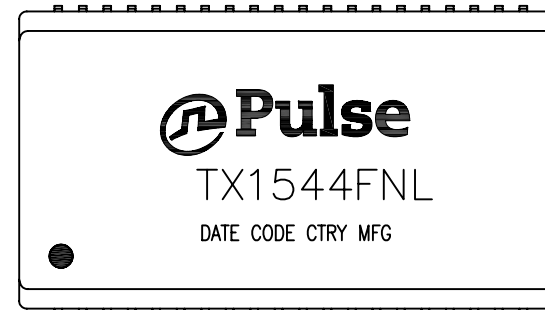

FINAL OUTLINE

© Copyright, 2014. Pulse Electronics Corp. All rights reserved. Pulse confidential & proprietary. (06/17/14)

PRODUCT DESCRIPTION	TLA DRAWING	PS DRAWING	SHEET	PART NO.	DATASHEET REV.
XFMR/CHK,OCT,T1/E1,QTERA,1:1CT:2,1:2 OH	TX1544FNL-10	PS-2743.001-A	1 OF 3	TX1544FNL	A

ELECTRICAL CHARACTERISTICS AT +25°C UNLESS OTHER SPECIFIED

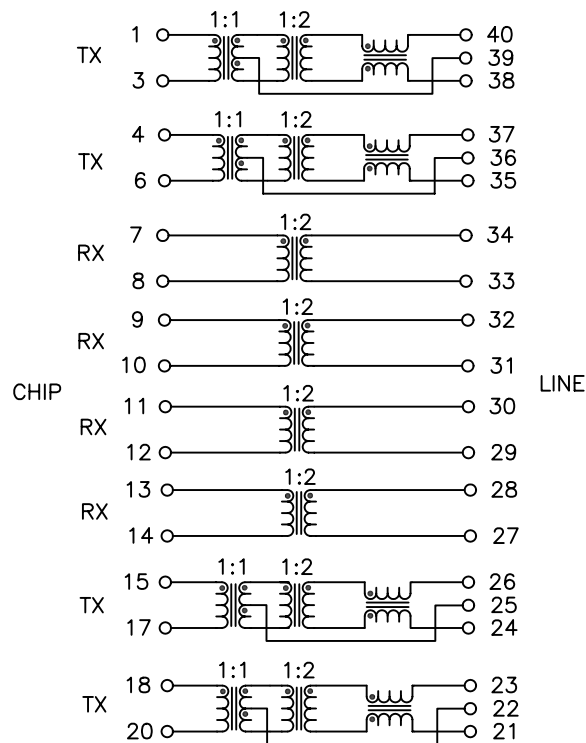

SCHMATIC

PARAMETER	SPECIFICATIONS
OPERATING TEMPERATURE	-40°C ~ +85°C
POLARITY	PER SCHEMATIC
TURNS RATIO @ 100 KHZ, 0.1 VRMS	$\frac{(40-38)}{(1-3)} = \frac{(37-35)}{(4-6)} = \frac{(26-24)}{(15-17)} = \frac{(23-21)}{(18-20)} = 2.0 \pm 2\%$ $\frac{(34-33)}{(7-8)} = \frac{(32-31)}{(9-10)} = \frac{(30-29)}{(11-12)} = \frac{(28-27)}{(13-14)} = 2.0 \pm 2\%$
INDUCTANCE (OCL) @ 100 KHZ, 0.02 VRMS	$(1-3) = (4-6) = (15-17) = (18-20) = 0.4 \text{ mH MINIMUM}$ $(7-8) = (9-10) = (11-12) = (13-14) = 0.4 \text{ mH MINIMUM}$
LEAKAGE INDUCTANCE @ 100 KHZ, 0.02 VRMS	$(1-3) \text{ WITH } (40-38) \text{ SHORTED} = 0.6 \text{ } \mu\text{H MAXIMUM}$ $(4-6) \text{ WITH } (37-35) \text{ SHORTED} = 0.6 \text{ } \mu\text{H MAXIMUM}$ $(15-17) \text{ WITH } (26-24) \text{ SHORTED} = 0.6 \text{ } \mu\text{H MAXIMUM}$ $(18-20) \text{ WITH } (23-21) \text{ SHORTED} = 0.6 \text{ } \mu\text{H MAXIMUM}$ $(7-8) \text{ WITH } (34-33) \text{ SHORTED} = 0.6 \text{ } \mu\text{H MAXIMUM}$ $(9-10) \text{ WITH } (32-31) \text{ SHORTED} = 0.6 \text{ } \mu\text{H MAXIMUM}$ $(11-12) \text{ WITH } (30-29) \text{ SHORTED} = 0.6 \text{ } \mu\text{H MAXIMUM}$ $(13-14) \text{ WITH } (28-27) \text{ SHORTED} = 0.6 \text{ } \mu\text{H MAXIMUM}$
CWW @ 100 KHZ, 1 VRMS	$(1-3) \text{ TO } (40-38) = 35\text{pF MAXIMUM}$ $(4-6) \text{ TO } (37-35) = 35\text{pF MAXIMUM}$ $(15-17) \text{ TO } (26-24) = 35\text{pF MAXIMUM}$ $(18-20) \text{ TO } (23-21) = 35\text{pF MAXIMUM}$ $(7-8) \text{ TO } (34-33) = 35\text{pF MAXIMUM}$ $(9-10) \text{ TO } (32-31) = 35\text{pF MAXIMUM}$ $(11-12) \text{ TO } (30-29) = 35\text{pF MAXIMUM}$ $(13-14) \text{ TO } (28-27) = 35\text{pF MAXIMUM}$
DC RESISTANCE	$(40-38) = (37-35) = (26-24) = (23-21) = 1.3 \text{ OHMS MAXIMUM}$ $(34-33) = (32-31) = (30-29) = (28-27) = 1.0 \text{ OHMS MAXIMUM}$ $(1-3) = (4-6) = (15-17) = (18-20) = 0.8 \text{ OHMS MAXIMUM}$ $(7-8) = (9-10) = (11-12) = (13-14) = 0.8 \text{ OHMS MAXIMUM}$
HIPOT	1500 VRMS FOR 60 SECONDS

© Copyright, 2014. Pulse Electronics Corp. All rights reserved. Pulse confidential & proprietary. (06/17/14)

PRODUCT DESCRIPTION	TLA DRAWING	PS DRAWING	SHEET	PART NO.	DATASHEET REV.
XFMR/CHK,OCT,T1/E1,QTERA,1:1CT:2,1:2 OH	TX1544FNL-10	PS-2743.001-A	2 OF 3	TX1544FNL	A

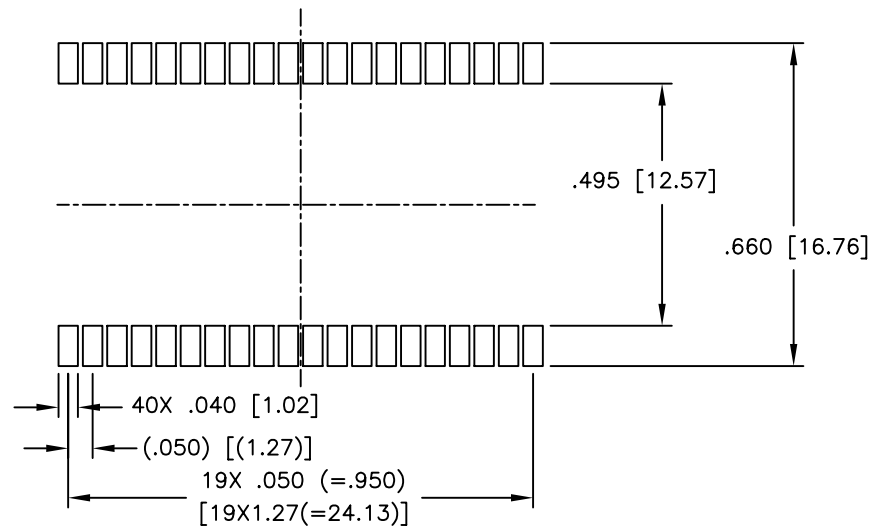
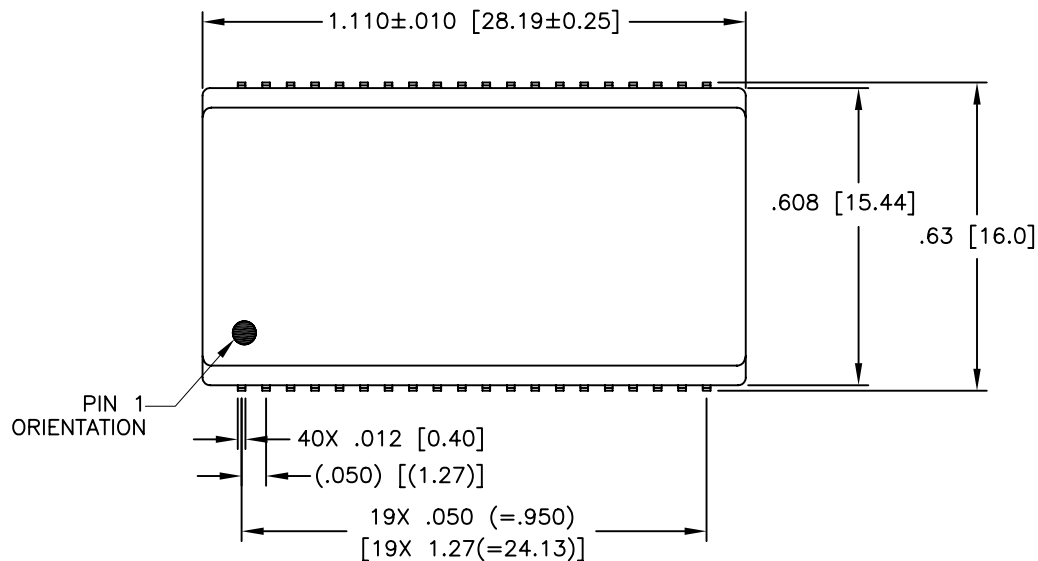

SUGGESTED PAD LAYOUT

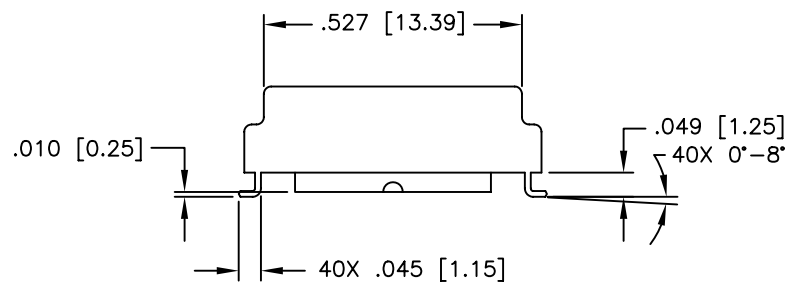
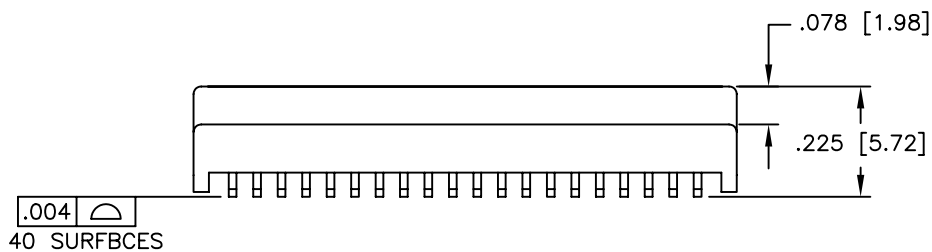

DIMENSIONS ARE IN INCHES [MILLIMETERS] WITH THE FOLLOWING TOLERANCES: [MILLIMETERS] ARE FOR REFERENCE ONLY.
 .XX= ±.01 [±0.25]
 .XXX= ±.005 [±0.13]

© Copyright, 2014. Pulse Electronics Corp. All rights reserved. Pulse confidential & proprietary. (06/17/14)

PRODUCT DESCRIPTION	TLA DRAWING	PS DRAWING	SHEET	PART NO.	DATASHEET REV.
XFMR/CHK,OCT,T1/E1,QTERA,1:1CT:2,1:2 OH	TX1544FNL-10	PS-2743.001-A	3 OF 3	TX1544FNL	A