

Photoelectrics Through-beam, Transistor Output Type PE12CNT15..

CARLO GAVAZZI



- Elevators, Escalators and Entrance control
- Range 15 m
- ESPE-Type 2, PL C.
- Modulated, infrared light
- Supply voltage: 10 to 30 VDC
- Output: 100 mA, NPN or PNP type
- Make or break switching
- LED for output indication or power supply
- Protection: reverse polarity, short circuit, transients
- Cable versions with or without connector
- Emitter mute and power adjustment
- CE, UL325 and UL508 approved



Product Description

The PE12CNT. is a family of general purpose Photoelectric sensors. They are specially designed for Elevators, Escalators, Entrance control to meet the requirements in the door market. The "snap-on"

housing can be mounted with a wall thickness from 0.6 mm to 2.25 mm. The emitter has a mute input to turn it off for evaluation of the sensor function. Available in 10-30 VDC version.

Ordering Key

PE12CNT15NO-C2

Type	_____
Housing style	_____
Housing size	_____
Housing material	_____
Sensor code	_____
Detection principle	_____
Sensing distance	_____
Output type	_____
Output configuration	_____
Connection type	_____
Cable connector	_____

Type Selection

Housing diameter	Range S _n	Con-nec-tor	Ordering no. Receiver NPN, NO	Ordering no. Receiver NPN, NC	Ordering no. Receiver PNP, NO	Ordering no. Receiver PNP, NC	Ordering no. Emitter
Ø 12 mm	15 m	NO	PE12CNT15NO	PE12CNT15NC	PE12CNT15PO	PE12CNT15PC	PE12CNT15
Ø 12 mm	15 m	YES	PE12CNT15NO-C2	PE12CNT15NC-C2	PE12CNT15PO-C2	PE12CNT15PC-C2	PE12CNT15-C2

Note: Please order emitter and receiver separately

Specifications Emitter

Rated operational volt. (U _B)	10 to 30 VDC	Light type	Infrared, modulated
Ripple (U _{rip})	≤ 10%	Light spot	940 mm @ 9 m
Supply current	≤ 20 mA	Emitter angle	± 3° @ 9 m
Protection	Reverse polarity, transients	Indication function	Power supply ON Mute input ON
Power ON delay (t _v)	≤ 100 ms	Power adjustment	R _x ~ 3 kΩ -10 kΩ
Control input			
Normal oper.	> 1.5 VDC		
Mute	< 1.2 VDC		
Light source	LED, 890 nm		

Specifications Receiver

Rated operating dist. (S_n)	15 m	Utility category	DC12	Control of resistive loads and solid state loads with optical isolation
Blind zone	None		DC13	Control of electromagnets
Temperature drift	≤ 0.4 %/°C	Ambient light	3,000 ... 3,200 K	> 80,000 LUX (EN60947-5-2)
Hysteresis (H)	3 - 20 %	Detection angle		± 2.5° @ 9 m
Rated operational volt. (U_B)	10 to 30 VDC (ripple included)	Operating frequency (f)		100 Hz
Ripple (U_{rrp})	≤ 10 %	Response time	OFF-ON (t _{ON})	≈ 6.5 ms
No load supply current (I_o)	≤ 16 mA		ON-OFF (t _{OFF})	≈ 3.5 ms
Output current		Power ON delay (t_v)		≤ 100 ms
Continuous (I _a)	≤ 100 mA	Output function	NPN or PNP	Make or break (NO or NC)
Short-time (I)	≤ 100 mA, (max. load capacity 100 nF)	Indication function	Output ON	LED, yellow
Minimum operational current (I_m)	0.5 mA			
OFF-state current (I_r)	≤ 100 μA			
Voltage drop (U_d)	≤ 1.6 VDC @ 100 mA			
Protection	Short-circuit, reverse polarity, transients			

General Specifications

Environment		Surge (EN 61000-4-5)	
Overvoltage category	III (IEC 60664/60664A, 60947-1)	Power-supply	> 1 kV (with 500 Ω)
Pollution degree	3 (IEC 60664/60664A, 60947-1)	Sensor output	> 1 kV (with 500 Ω)
Degree of protection	IP67 (IEC 60529; EN60947-1) 1, 2, 12 (NEMA types)	Wire conducted disturbances (EN 61000-4-6)	> 10 Vrms
Temperature		Power-frequency magnetic fields (EN 61000-4-8)	
Operating	-20° to +50°C (-4° to +122°F)	Continuous	> 30 A/m, 38 μ tesla
Storage	-25° to +80°C (-13° to +176°F)	Short-time	> 300 A/m, 380 μ tesla
Rated insulation voltage	75 VDC	Vibration (IEC 60068-2-6)	10 to 150 Hz, 1 mm / 15 g
Dielectric test voltage	500 Vac rms (EN60947-1)	Shock (IEC 60068-2-27)	30 g / 11 ms, 6 pos, 6 neg per axis
Rated impulse withstand test	800 V (1.2 / 50 μs) (EN60947-1)	Free fall (IEC 60068-2-31)	2 times from 1 m, 100 times from 0.5 m
ESPE	Type 2	Pig-tail connector (-C2)	3-pol micro MATE-N-LOK Series, AMP/TE
PFH_d	6 x 10 ⁻⁸ failure per hour (worst case SRP for CS)	Housing material	
Diagnostic coverage	99 % (EN13849-1: 2008)	Body PE12	PC black
Performance level	C (EN13849-1: 2008)	Front glass	PC black
MTTF_d (worst case full sensor)	298 Years (worst case full receiver) EN ISO 13849-1, SN 29500 368 Years (worst case full emitter) EN ISO 13849-1, SN 29500	Connection	
Electrostatic discharge (EN61000-4-2)		Cable	PVC, Emitter: grey / Receiver: black, 5 m, 3 x 0.14 mm ² , Ø 2.9 mm
Contact discharge	> 12 kV	Weight	
Air discharge	> 8 kV	Emitter	80 g
Radiated RF electromagnetic fields (EN 61000-4-3)	> 10 V/m	Receiver	80 g
Electrical fast transients/burst (EN 61000-4-4)	± 4 kV	CE-marking	EN12445, EN12453, EN12978, EN 60947-5-2
		UL-Approval	UL325 UL508, CSA-C22.2 No.247

Operation Diagram

tv = Power ON delay

Power supply

Target emitter present

Object present

Break (NC) Output ON

Make (NO) Output ON

Mute active ≤ 1.2 VDC

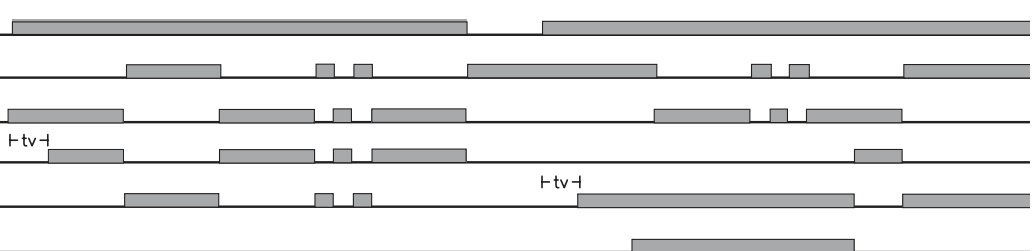

Dimensions (mm)

PE12.....

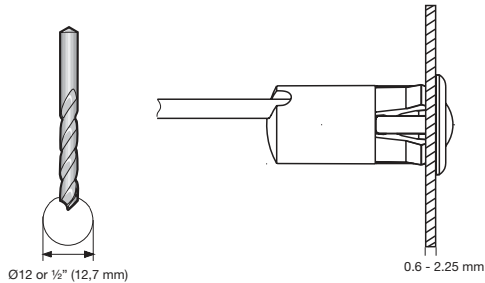
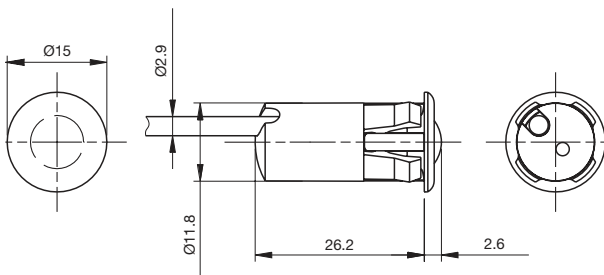

PE12.....-C2 with connector

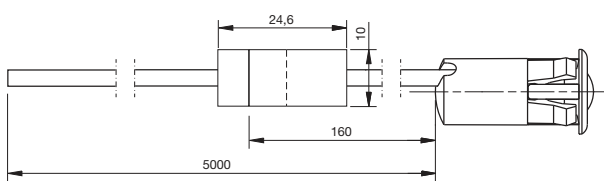

To be mounted in material with a thickness of 0.6 - 2.25 mm

Detection Diagram

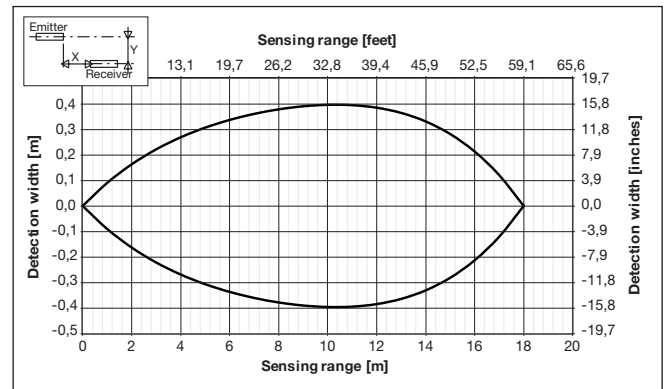

Excess Gain

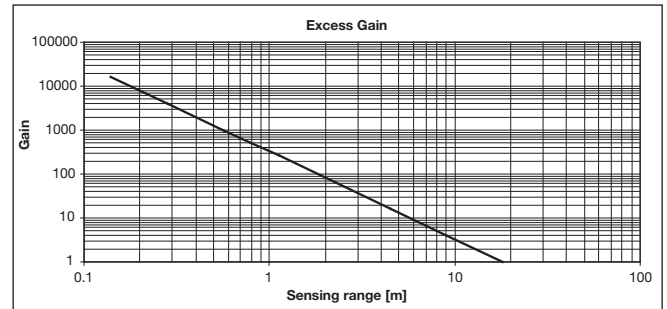

Power adjustment curve

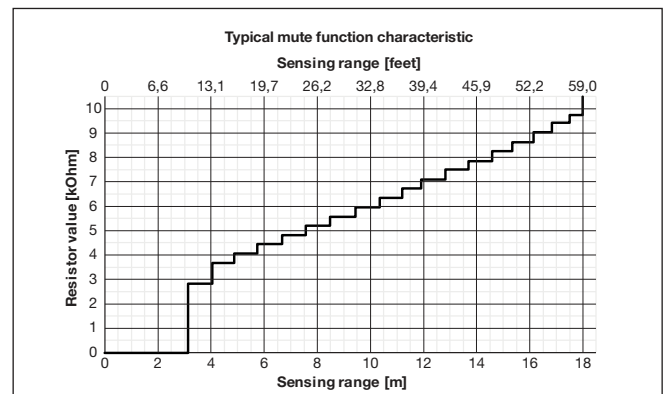

Wiring Diagram

Delivery Contents

- PE12...
- **Packaging:** plastic bag

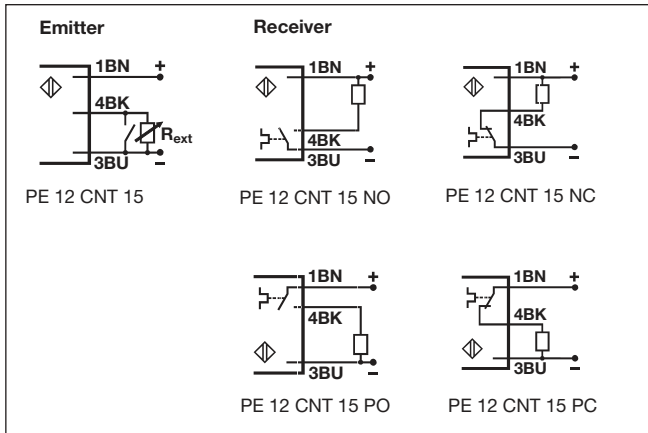

Installation Hints

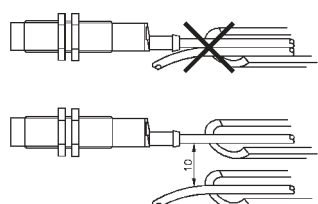
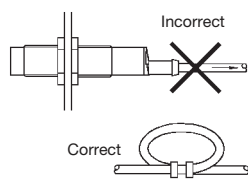
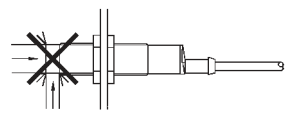
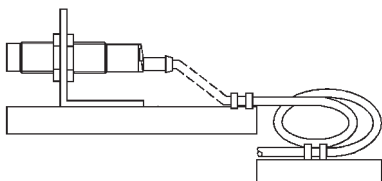
<p>To avoid interference from inductive voltage/current peaks, separate the prox. switch power cables from any other power cables, e.g. motor, contactor or solenoid cables</p> 	<p>Relief of cable strain</p>  <p>The cable should not be pulled</p>	<p>Protection of the sensing face</p>  <p>A proximity switch should not serve as mechanical stop</p>	<p>Switch mounted on mobile carrier</p>  <p>Any repetitive flexing of the cable should be avoided</p>
---	--	--	---