

SSQE48T13050

Sixteenth-Brick DC-DC Converter

The new SSQE48T13050 DC-DC converter is an open frame sixteenth-brick DC-DC converter that conforms to the Distributed Open Standards Architecture (DOSA) specifications. The converter operates over an input voltage range of 36 to 75 VDC, and provides a tightly regulated output voltage with an output current up to 13 A. The output is fully isolated from the input and the converter meets Basic Insulation requirements permitting a positive or negative output configuration.

The converter is constructed using a single-board approach with both planar and discrete magnetics. The standard feature set includes remote On/Off (positive or negative logic), input undervoltage lockout, output overvoltage, overcurrent, and short circuit protections, output voltage trim, and overtemperature shutdown with hysteresis.

With standard pinout and trim equations and excellent thermal performance, the SSQE48T13050 converters can replace in most cases existing eighth-brick converters. Inclusion of this converter in a new design can result in significant board space and cost savings.

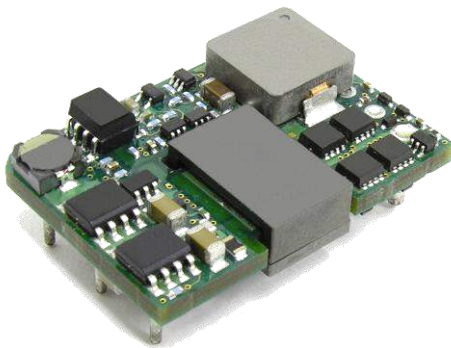

Key Features & Benefits

- 36-75 VDC Input; 5 VDC @ 13 A, 65 W Output
- Industry-standard DOSA pinout
- On-board input differential LC-filter
- Start-up into pre-biased load
- No minimum load required
- Withstands 100 V input transient for 100 ms
- Fixed-frequency operation
- Hiccup overcurrent protection
- Fully protected (OTP, OCP, OVP, UVLO)
- Remote sense
- Remote ON/OFF positive or negative logic option
- Output voltage trim range: +10% / -20% with industry-standard trim equations
- Designed to meet Class B conducted emissions per FCC and EN55022 when used with external filter
- All materials meet UL94, V-0 flammability rating
- Approved to the latest edition and amendment of ITE Safety standards, UL/CSA 60950-1 and IEC60950-1
- RoHS lead free solder and lead-solder-exempted products are available

SSQE48T13050

1. ELECTRICAL SPECIFICATIONS

Conditions: $T_A = 25^\circ\text{C}$, Airflow = 300 LFM (1.5 m/s), $V_{in} = 48\text{ VDC}$, $C_{in} = 33\ \mu\text{F}$, unless otherwise specified.

PARAMETER	CONDITIONS / DESCRIPTION	MIN	TYP	MAX	UNITS
Absolute Maximum Ratings					
Input Voltage	Continuous	0		80	VDC
Operating Ambient Temperature		-40		85	$^\circ\text{C}$
Storage Temperature		-55		125	$^\circ\text{C}$
Isolation Characteristics					
I/O Isolation		2250			VDC
Isolation Capacitance			150		pF
Isolation Resistance		10			M Ω
Feature Characteristics					
Switching Frequency		411	440	469	kHz
Output Voltage Trim Range ¹	Industry-standard equations (5.0 V)	-20		+10	%
Remote Sense Compensation ¹	Percent of $V_{OUT(NOM)}$			+10	%
Output Overvoltage Protection	Non-latching	120	130	140	%
Overtemperature Shutdown (PCB)	Non-latching		125		$^\circ\text{C}$
Peak Back-drive Output Current during startup into pre-biased output	Sinking current from external voltage source equal $V_{OUT(NOM)} - 0.6\text{ V}$ and connected to output via 1 Ohm resistor			50	mADC
Back-drive Output Current in OFF state	Converter is OFF; External voltage = 5 VDC		10		mADC
Auto-Restart Period	Applies to all protection features		200		ms
Turn-On Time	See Figures E, F, and G		5		ms
ON/OFF Control (Positive Logic)	Converter Off (logic low)	-20		0.8	VDC
	Converter On (logic high)	2.4		20	VDC
ON/OFF Control (Negative Logic)	Converter Off (logic high)	2.4		20	VDC
	Converter On (logic low)	-20		0.8	VDC
Mechanical					
Dimension			0.9 x 1.3 x 0.374		in
Weight			12.3		g
Reliability					
MTBF	Telcordia SR-332, Method I Case 1 50% electrical stress, 40 $^\circ\text{C}$ ambient	16.23			MHrs

¹ V_{out} can be increased up to 10% via the sense leads or 10% via the trim function. However, the total output voltage trim from all sources shall not exceed 10% of $V_{OUT(NOM)}$ in order to ensure specified operation of overvoltage protection circuitry.

SSQE48T13050

PARAMETER	CONDITIONS / DESCRIPTION	MIN	TYP	MAX	UNITS
Input Characteristics					
Operating Input Voltage Range		36	48	75	VDC
Input Under-voltage Lockout					
Turn-on Threshold		34	35	36	VDC
Turn-off Threshold		32	33	34	VDC
Input Voltage Transient	100 ms			100	VDC
Maximum Input Current	$V_{IN} = 36 \text{ VDC}$, $I_{OUT} = 13 \text{ ADC}$			2.1	ADC
Input Stand-by Current	$V_{in} = 48 \text{ V}$, converter disabled		10		mA
Input No Load Current (0 load on the output)	$V_{in} = 48 \text{ V}$, converter enabled		32		mA
Input Reflected-Ripple Current, i_s	$V_{in} = 48 \text{ V}$, 25 MHz bandwidth		10		mA _{PK-PK}
Input Voltage Ripple Rejection	120 Hz		90		dB
Output Characteristics					
External Load Capacitance	Plus full resistive load			10,000	μF
Output Current Range	5.0 VDC	0		13	ADC
Current Limit Inception	Non-latching, for 5.0 VDC	14.3		18.2	ADC
Peak Short-Circuit Current	Non-latching, Short = 10 m Ω		18.2		A
RMS Short-Circuit Current	Non-latching		1.1		Arms
Output Voltage Setpoint Accuracy (no load)		-1.6		+1.6	% V_{OUT}
Output Regulation	Over Line		± 2	± 5	mV
	Over Load		± 2	± 5	mV
Overall Output Voltage Regulation	Over line, load and temperature ²	-3		+3	% V_{out}
Output Ripple and Noise – 25 MHz bandwidth	Full load + 10 μF tantalum + 1 μF ceramic		50	100	mV _{PK-PK}
Dynamic Response					
Load Change 50%-75%-50% of $I_{out \text{ Max}}$, $di/dt = 0.1 \text{ A}/\mu\text{s}$	$C_o = 1 \mu\text{F}$ ceramic + 10 μF tantalum Figure 8		80		mV
Settling Time to 1% of V_{out}			80		μs
Load Change 50%-75%-50% of $I_{out \text{ Max}}$, $di/dt = 5 \text{ A}/\mu\text{s}$	$C_o = 470 \mu\text{F}$ POS + 1 μF ceramic Figure 9		100		mV
Settling Time to 1% of V_{out}			40		μs
Efficiency					
100% Load	$V_{OUT} = 5.0 \text{ VDC}$		90		%
50% Load	$V_{OUT} = 5.0 \text{ VDC}$		90.7		%

² Operating ambient temperature range is -40°C to 85°C

SSQE48T13050

2. OPERATIONS

2.1 INPUT AND OUTPUT IMPEDANCE

These power converters have been designed to be stable with no external capacitors when used in low inductance input and output circuits.

However, in some applications, the inductance associated with the distribution from the power source to the input of the converter can affect the stability of the converter. A 33 μF electrolytic capacitor with an ESR $< 1\Omega$ across the input is recommended to ensure stability of the converter over the wide range of input source impedance.

In many applications, the user has to use decoupling capacitance at the load. The power converter will exhibit stable operation with external load capacitance up to 10,000 μF .

2.2 ON/OFF (Pin 2)

The ON/OFF pin is used to turn the power converter on or off remotely via a system signal. There are two remote control options available, positive and negative logic, both referenced to $V_{in(-)}$. A typical connection is shown in Fig. A.

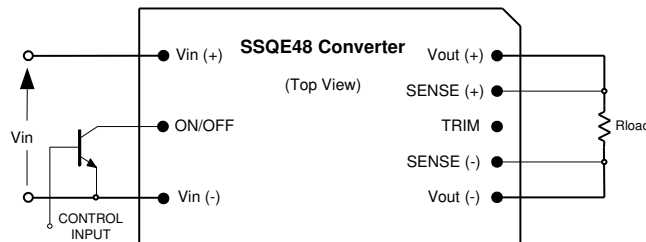

Figure A. Circuit configuration for ON/OFF function.

The positive logic version turns on when the ON/OFF pin is at a logic high and turns off when the pin is at a logic low. The converter is on when the ON/OFF pin is left open. See the Electrical Specifications for logic high/low definitions.

The negative logic version turns on when the pin is at a logic low and turns off when the pin is at a logic high. The ON/OFF pin can be hard wired directly to $V_{in(-)}$ to enable automatic power up of the converter without the need of an external control signal.

The ON/OFF pin is internally pulled up to 5 V through a resistor. A properly de-bounced mechanical switch, open-collector transistor, or FET can be used to drive the input of the ON/OFF pin. The device must be capable of sinking up to 0.2 mA at a low level voltage of ≤ 0.8 V. An external voltage source (± 20 V maximum) may be connected directly to the ON/OFF input, in which case it must be capable of sourcing or sinking up to 1 mA depending on the signal polarity. See the Startup Information section for system timing waveforms associated with use of the ON/OFF pin.

2.3 REMOTE SENSE (PINS 5 AND 7)

The remote sense feature of the converter compensates for voltage drops occurring between the output pins of the converter and the load. The SENSE(-) (Pin 5) and SENSE(+) (Pin 7) pins should be connected at the load or at the point where regulation is required (see Fig. B).

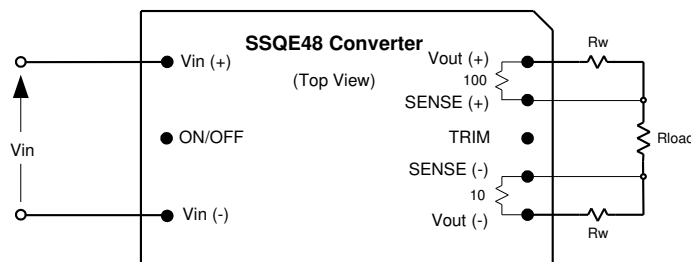

Figure B. Remote sense circuit configuration.

SSQE48T13050

CAUTION

If remote sensing is not utilized, the SENSE(-) pin must be connected to the Vout(-) pin (Pin 4), and the SENSE(+) pin must be connected to the Vout(+) pin (Pin 8) to ensure the converter will regulate at the specified output voltage. If these connections are not made, the converter will deliver an output voltage that is higher than the specified data sheet value.

Because the sense leads carry minimal current, large traces on the end-user board are not required. However, sense traces should be run side by side and located close to a ground plane to minimize system noise and ensure optimum performance. The converter's output overvoltage protection (OVP) senses the voltage across Vout(+) and Vout(-), and not across the sense lines, so the resistance (and resulting voltage drop) between the output pins of the converter and the load should be minimized to prevent unwanted triggering of the OVP.

When utilizing the remote sense feature, care must be taken not to exceed the maximum allowable output power capability of the converter, which is equal to the product of the nominal output voltage and the allowable output current for the given conditions.

When using remote sense, the output voltage at the converter can be increased by as much as 10% above the nominal rating in order to maintain the required voltage across the load. Therefore, the designer must, if necessary, decrease the maximum current (originally obtained from the derating curves) by the same percentage to ensure the converter's actual output power remains at or below the maximum allowable output power.

2.4 OUTPUT VOLTAGE ADJUST /TRIM (PIN 6)

The output voltage can be adjusted up 10% or down 20%. Trim up to 10% is guaranteed only at $V_{in} \geq 40V$, and it is approximately 8% to 10% at $V_{in} = 36V$.

The TRIM pin should be left open if trimming is not being used. To minimize noise pickup, a 0.1 μF capacitor is connected internally between the TRIM and SENSE(-) pins.

To increase the output voltage, refer to Fig. C. A trim resistor, R_{T-INCR} , should be connected between the TRIM (Pin 6) and SENSE(+) (Pin 7), with a value of:

$$R_{T-INCR} = \frac{5.11(100 + \Delta)V_{O-NOM} - 626}{1.225\Delta} - 10.22 \quad [k\Omega],$$

where,

R_{T-INCR} = Required value of trim-up resistor [k Ω]

V_{O-NOM} = Nominal value of output voltage [V]

$$\Delta = \left| \frac{(V_{O-REQ} - V_{O-NOM})}{V_{O-NOM}} \right| \times 100 \quad [\%]$$

V_{O-REQ} = Desired (trimmed) output voltage [V].

When trimming up, care must be taken not to exceed the converter's maximum allowable output power. See the previous section for a complete discussion of this requirement.

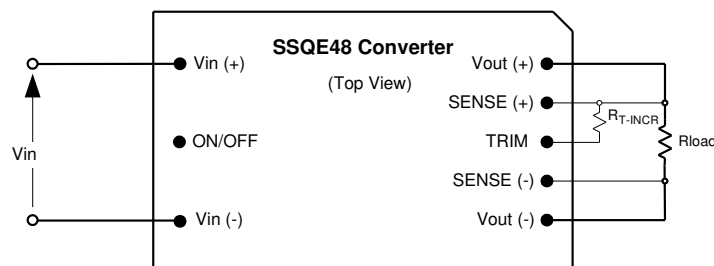

Figure C. Configuration for increasing output voltage.

To decrease the output voltage (Fig. D), a trim resistor, R_{T-DECR} , should be connected between the TRIM (Pin 6) and SENSE(-) (Pin 5), with a value of:

SSQE48T13050

$$R_{T-DECR} = \frac{511}{|\Delta|} - 10.22 \quad [\text{k}\Omega]$$

where,

R_{T-DECR} = Required value of trim-down resistor [kΩ]

and Δ is defined above.

Note:

The above equations for calculation of trim resistor values match those typically used in conventional industry-standard quarter-bricks, eighth-bricks and sixteenth-bricks.

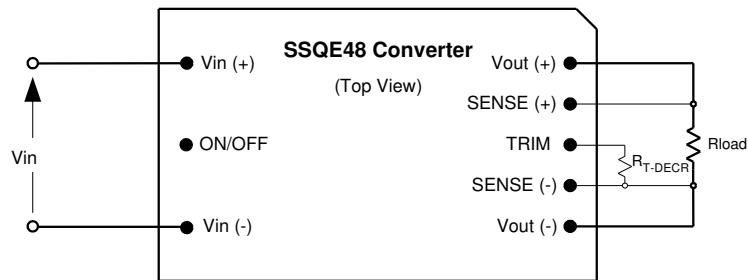

Figure D. Configuration for decreasing output voltage.

Trimming/sensing beyond 110% of the rated output voltage is not an acceptable design practice, as this condition could cause unwanted triggering of the output overvoltage protection (OVP) circuit. The designer should ensure that the difference between the voltages across the converter's output pins and its sense pins does not exceed 10% of $V_{out(nom)}$, or:

$$[V_{OUT(+)} - V_{OUT(-)}] - [V_{SENSE(+)} - V_{SENSE(-)}] \leq V_{O-NOM} \times 10\% \quad [V]$$

This equation is applicable for any condition of output sensing and/or output trim.

3. PROTECTION FEATURES

3.1 INPUT UNDERVOLTAGE LOCKOUT

Input undervoltage lockout is standard with this converter. The converter will shut down when the input voltage drops below a pre-determined voltage.

The input voltage must be typically 35 V for the converter to turn on. Once the converter has been turned on, it will shut off when the input voltage drops typically below 33 V. This feature is beneficial in preventing deep discharging of batteries used in telecom applications.

3.2 OUTPUT OVERCURRENT PROTECTION (OCP)

The converter is protected against overcurrent or short circuit conditions. Upon sensing an overcurrent condition, the converter will switch to constant current operation and thereby begin to reduce output voltage. During short circuit, when the output voltage drops significantly below 50% its nominal value, the converter will shut down.

Once the converter has shut down, it will attempt to restart nominally every 200 ms with a very low duty cycle. The attempted restart will continue indefinitely until the overload or short circuit conditions are removed.

Once the output current is brought back into its specified range, the converter automatically exits the hiccup mode and continues normal operation.

SSQE48T13050

3.3 OUTPUT OVERVOLTAGE PROTECTION (OVP)

The converter will shut down if the output voltage across Vout(+) (Pin 8) and Vout(-) (Pin 4) exceeds the threshold of the OVP circuitry. The OVP circuitry contains its own reference, independent of the output voltage regulation loop. Once the converter has shut down, it will attempt to restart every 200 ms until the OVP condition is removed.

3.4 OVERTEMPERATURE PROTECTION (OTP)

The converter will shut down under an overtemperature condition to protect itself from overheating caused by operation outside the thermal derating curves, or operation in abnormal conditions such as system fan failure. Converter will automatically restart after it has cooled to a safe operating temperature.

3.5 SAFETY REQUIREMENTS

The converters are safety approved to UL/CSA60950-1, EN60950-1, and IEC60950-1. Basic Insulation is provided between input and output.

The converters have no internal fuse. If required, the external fuse needs to be provided to protect the converter from catastrophic failure. Refer to the “Input Fuse Selection for DC/DC converters” application note on belpowersolutions.com for proper selection of the input fuse. Both input traces and the chassis ground trace (if applicable) must be capable of conducting a current of 1.5 times the value of the fuse without opening. The fuse must not be placed in the grounded input line.

Abnormal and component failure tests were conducted with the input protected by a 5A fuse. If a fuse rated greater than 5A is used, additional testing may be required. To protect a group of converters with a single fuse, the rating can be increased from the recommended value above.

3.6 ELECTROMAGNETIC COMPATIBILITY (EMC)

EMC requirements must be met at the end-product system level, as no specific standards dedicated to EMC characteristics of board mounted component DC-DC converters exist. However, Bel Power Solutions tests its converters to several system level standards, primary of which is the more stringent EN55022, *Information technology equipment - Radio disturbance characteristics-Limits and methods of measurement*.

An effective internal LC differential filter significantly reduces input reflected ripple current, and improves EMC.

With the addition of a simple external filter, all versions of the SSQE48T13050 converters pass the requirements of Class B conducted emissions per EN55022 and FCC requirements. Please contact Bel Power Solutions Applications Engineering for details of this testing.

3.7 STARTUP INFORMATION (USING NEGATIVE ON/OFF)

Scenario #1: Initial Startup From Bulk Supply

ON/OFF function enabled, converter started via application of V_{IN}. See Figure E.

Time	Comments
t ₀	ON/OFF pin is ON; system front-end power is toggled on, V _{IN} to converter begins to rise.
t ₁	V _{IN} crosses undervoltage Lockout protection circuit threshold; converter enabled.
t ₂	Converter begins to respond to turn-on command (converter turn-on delay).
t ₃	Converter V _{OUT} reaches 100% of nominal value.

For this example, the total converter startup time (t₃ - t₁) is typically 5 ms.

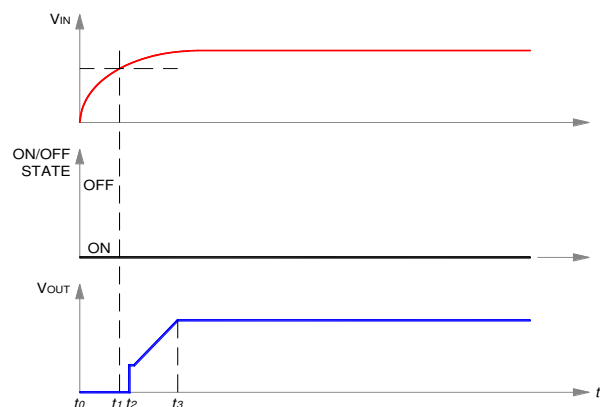

Figure E. Startup scenario #1.

SSQE48T13050

Scenario #2: Initial Startup Using ON/OFF Pin

With V_{IN} previously powered, converter started via ON/OFF pin. See Figure F.

Time	Comments
t_0	V_{INPUT} at nominal value.
t_1	Arbitrary time when ON/OFF pin is enabled (converter enabled).
t_2	End of converter turn-on delay.
t_3	Converter V_{OUT} reaches 100% of nominal value.

For this example, the total converter startup time ($t_3 - t_1$) is typically 5 ms.

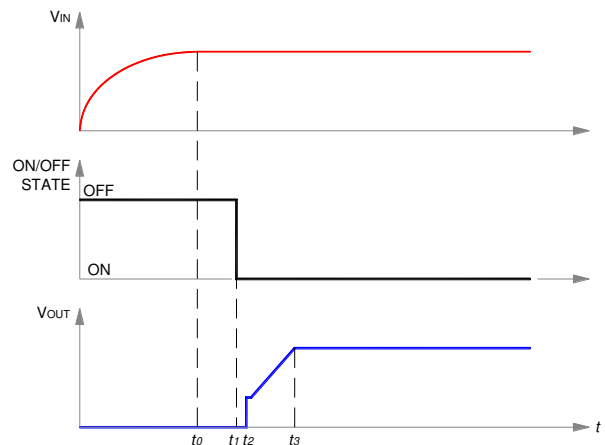

Figure F. Startup scenario #2.

Scenario #3: Turn-off and Restart Using ON/OFF Pin

With V_{IN} previously powered, converter is disabled and then enabled via ON/OFF pin. See Figure G.

Time	Comments
t_0	V_{IN} and V_{OUT} are at nominal values; ON/OFF pin ON.
t_1	ON/OFF pin arbitrarily disabled; converter output falls to zero; turn-on inhibit delay period (200 ms typical) is initiated, and ON/OFF pin action is internally inhibited.
t_2	ON/OFF pin is externally re-enabled. If $(t_2 - t_1) \leq 200$ ms, external action of ON/OFF pin is locked out by startup inhibit timer. If $(t_2 - t_1) > 200$ ms, ON/OFF pin action is internally enabled.
t_3	Turn-on inhibit delay period ends. If ON/OFF pin is ON, converter begins turn-on; if off, converter awaits ON/OFF pin ON signal; see Figure F.
t_4	End of converter turn-on delay.
t_5	Converter V_{OUT} reaches 100% of nominal value.

For the condition, $(t_2 - t_1) \leq 200$ ms, the total converter startup time ($t_5 - t_2$) is typically 205 ms. For $(t_2 - t_1) > 200$ ms, startup will be typically 5 ms after release of ON/OFF pin.

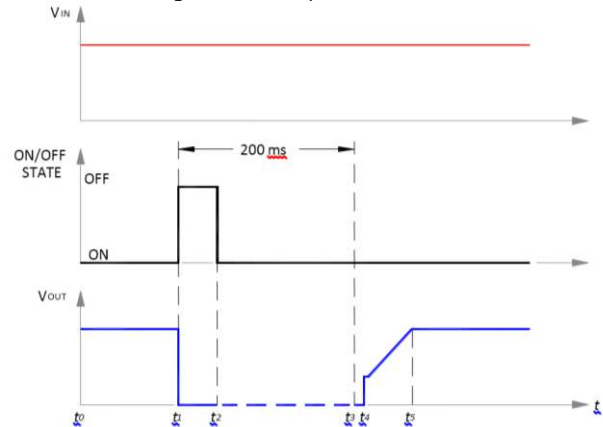

Figure G. Startup scenario #3.

4. CHARACTERIZATION

4.1 GENERAL INFORMATION

The converters have been characterized for many operational aspects, to include thermal derating (maximum load current as a function of ambient temperature and airflow) for vertical and horizontal mounting, efficiency, startup and shutdown parameters, output ripple and noise, transient response to load step-change, overload, and short circuit.

4.2 TEST CONDITIONS

All data presented were taken with the converter soldered to a test board, specifically a 0.060" thick printed wiring board (PWB) with four layers. The top and bottom layers were not metallized. The two inner layers, comprised of two-ounce copper, were used to provide traces for connectivity to the converter.

The lack of metallization on the outer layers as well as the limited thermal connection ensured that heat transfer from the converter to the PWB was minimized. This provides a worst-case but consistent scenario for thermal derating purposes.

All measurements requiring airflow were made in the vertical and horizontal wind tunnel using Infrared (IR) thermography and thermocouples for thermometry.

SSQE48T13050

Ensuring components on the converter do not exceed their ratings is important to maintaining high reliability. If one anticipates operating the converter at or close to the maximum loads specified in the derating curves, it is prudent to check actual operating temperatures in the application. Thermographic imaging is preferable; if this capability is not available, then thermocouples may be used. The use of AWG #40 gauge thermocouples is recommended to ensure measurement accuracy. Careful routing of the thermocouple leads will further minimize measurement error. Refer to Fig. H for the recommended measuring thermocouple location.

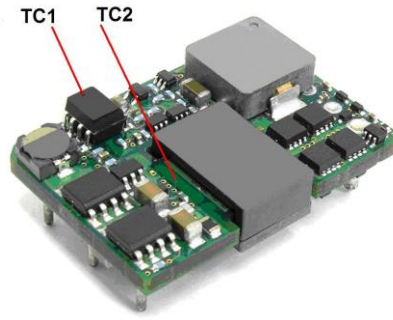

Fig. H: Location of the thermocouple for thermal testing.

4.3 THERMAL DERATING

Load current vs. ambient temperature and airflow rates are given in Figure 1. Ambient temperature was varied between 25 °C and 85 °C, with airflow rates from 30 to 500 LFM (0.15 to 2.5 m/s).

For each set of conditions, the maximum load current was defined as the lowest of:

- (i) The output current at which any FET junction temperature does not exceed a maximum specified temperature of 125°C as indicated by the thermographic image, or
- (ii) The temperature of the transformer does not exceed 125°C, or
- (iii) The nominal rating of the converter.

During normal operation, derating curves with maximum FET temperature less or equal to 125°C should not be exceeded. Temperature at thermocouple locations TC1 and TC2 shown in Fig. H should not exceed 100°C and 125°C respectively, in order to operate inside the derating curves.

4.4 EFFICIENCY

Figure 2 shows the efficiency vs. load current plot for ambient temperature of 25°C, airflow rate of 300 LFM (1.5 m/s) with vertical mounting and input voltages of 36V, 48V, 65V, and 75V. Also, a plot of efficiency vs. load current, as a function of ambient temperature with $V_{in}=48V$, airflow rate of 200 LFM (1 m/s) with vertical mounting is shown in Figure 3.

4.5 POWER DISSIPATION

Figure 4 shows the power dissipation vs. load current plot for $T_a = 25^\circ\text{C}$, airflow rate of 300 LFM (1.5 m/s) with vertical mounting and input voltages of 36 V, 48 V, 65 V, and 75 V. Also, a plot of power dissipation vs. load current, as a function of ambient temperature with $V_{in} = 48 V$, airflow rate of 200 LFM (1 m/s) with vertical mounting is shown in Figure 5.

4.6 STARTUP

Output voltage waveforms during the turn-on transient using the ON/OFF pin for full rated load currents (resistive load) are shown without and with external load capacitance in Figure 6 and Figure 7, respectively.

4.7 RIPPLE AND NOISE

Figure 10 shows the output voltage ripple waveform, measured at full rated load current with a 10 μF tantalum and 1 μF ceramic capacitor across the output. Note that all output voltage waveforms are measured across a 1 μF ceramic capacitor. The input reflected-ripple current waveforms are obtained using the test setup shown in Figure 11.

SSQE48T13050

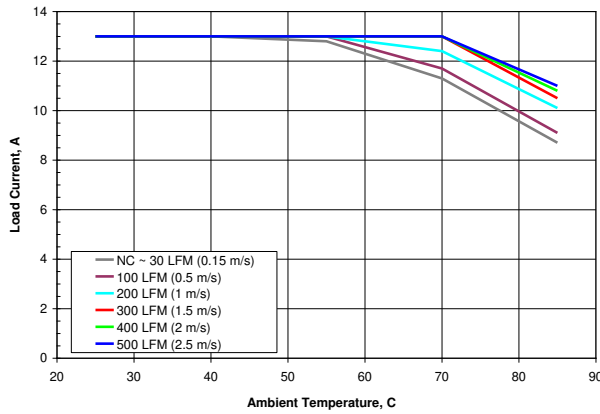

Figure 1. Available load current vs. ambient air temperature and airflow rates for SSQE48T13050 converter mounted vertically with air flowing from pin 1 to pin 3, $V_{in} = 48 V$.
Note: NC – Natural convection

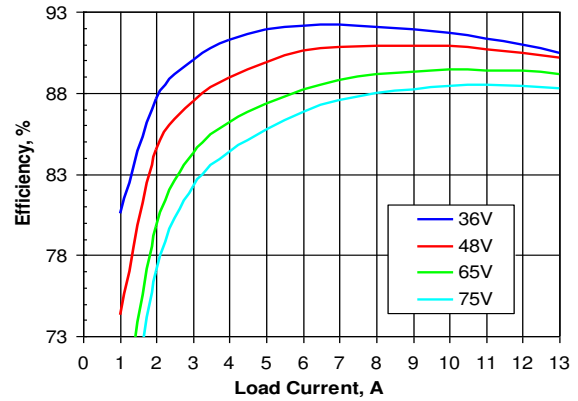

Figure 2. Efficiency vs. load current and input voltage for SSQE48T13050 converter mounted vertically with air flowing from pin 1 to pin 3 at a rate of 300 LFM (1.5 m/s) and $T_a = 25^\circ C$.

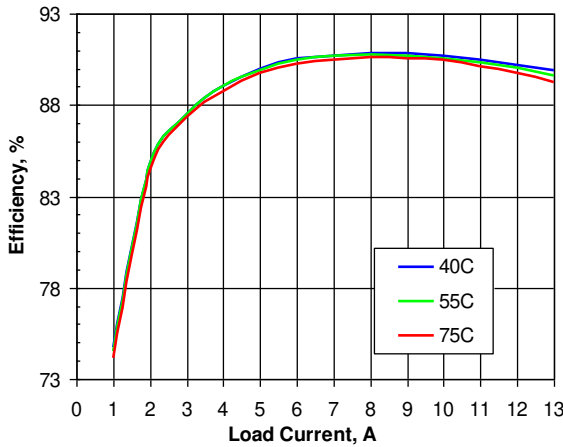

Figure 3 Efficiency vs. load current and ambient temperature for SSQE48T13050 converter mounted vertically with $V_{in} = 48 V$ and air flowing from pin 1 to pin 3 at a rate of 200 LFM (1.0 m/s).

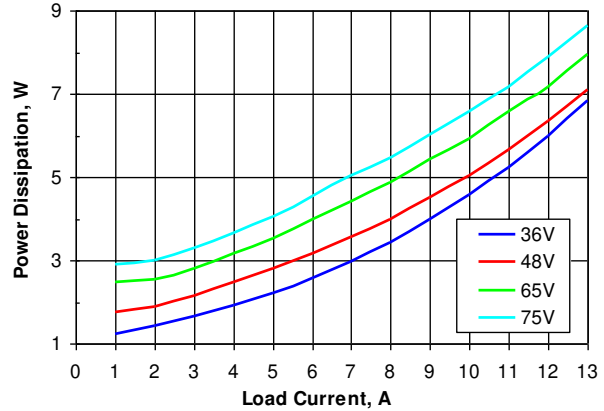

Figure 4. Power dissipation vs. load current and input voltage for SSQE48T13050 converter mounted vertically with air flowing from pin 1 to pin 3 at a rate of 300 LFM (1.5 m/s) and $T_a = 25^\circ C$

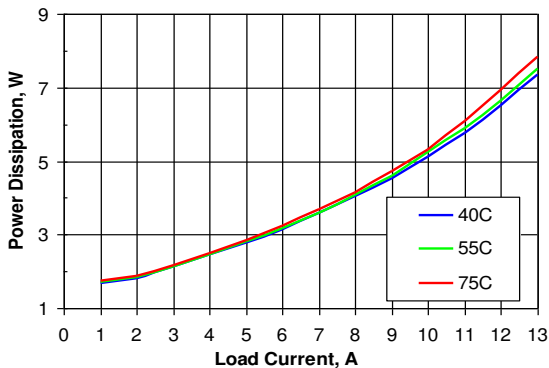

Figure 5. Power dissipation vs. load current and ambient temperature for SSQE48T13050 converter mounted vertically with $V_{in} = 48 V$ and air flowing from pin 1 to pin 3 at a rate of 200 LFM (1.0 m/s).

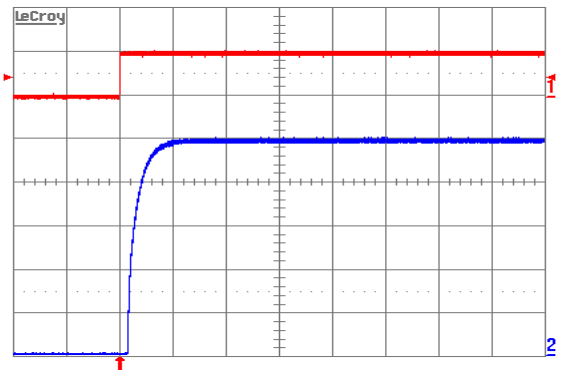

Figure 6. Turn-on transient at full rated load current (resistive) with no output capacitor at $V_{in} = 48 V$, triggered via ON/OFF pin. Top trace: ON/OFF signal (5 V/div.). Bottom trace: Output voltage (1.0 V/div.). Time scale: 5 ms/div.

SSQE48T13050

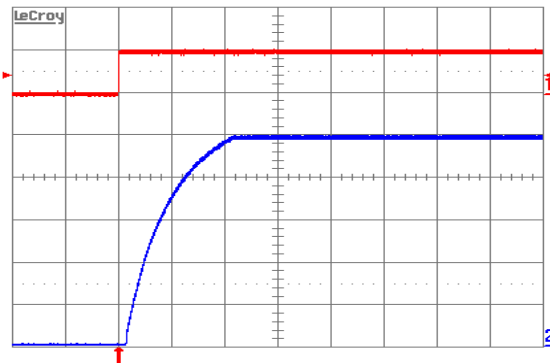

Figure 7. Turn-on transient at full rated load current (resistive) plus 10,000 μF at $V_{in} = 48\text{ V}$, triggered via ON/OFF pin. Top trace: ON/OFF signal (5 V/div.). Bottom trace: Output voltage (1 V/div.). Time scale: 5 ms/div.

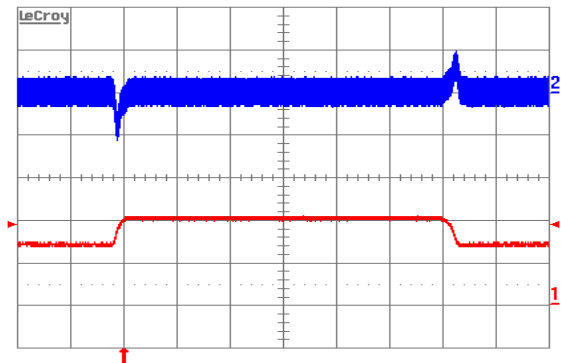

Figure 8. Output voltage response to load current step-change (6.5 A–9.75 A–6.5 A) at $V_{in} = 48\text{ V}$. Top trace: output voltage (100 mV/div.). Bottom trace: load current (5 A/div.). Current slew rate: 0.1A/ μs . $C_o = 1\mu\text{F}$ ceramic + 10 μF tantalum. Time scale: 0.2 ms/div.

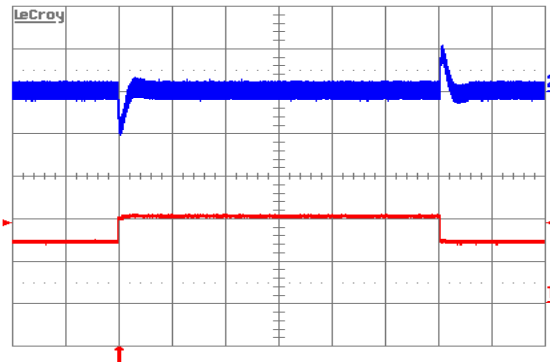

Figure 9. Output voltage response to load current step-change (6.5 A–9.75 A–6.5 A) at $V_{in} = 48\text{ V}$. Top trace: output voltage (100 mV/div.). Bottom trace: load current (5A/div.). Current slew rate: 5 A/ μs . $C_o = 470\mu\text{F}$ POS + 1 μF ceramic. Time scale: 0.2 ms/div.

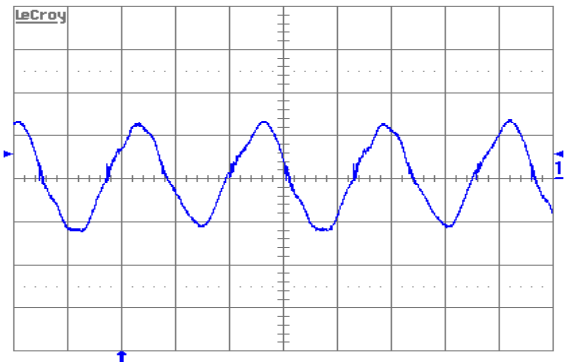

Figure 10. Output voltage ripple (20 mV/div.) at full rated load current into a resistive load with $C_o = 10\mu\text{F}$ tantalum + 1 μF ceramic and $V_{in} = 48\text{ V}$. Time scale: 1 μs /div.

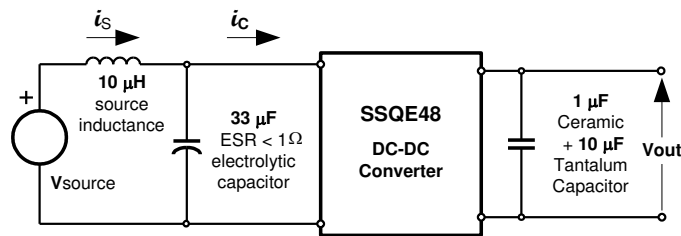

Figure 11. Test setup for measuring input reflected ripple currents, i_c and i_s .

SSQE48T13050

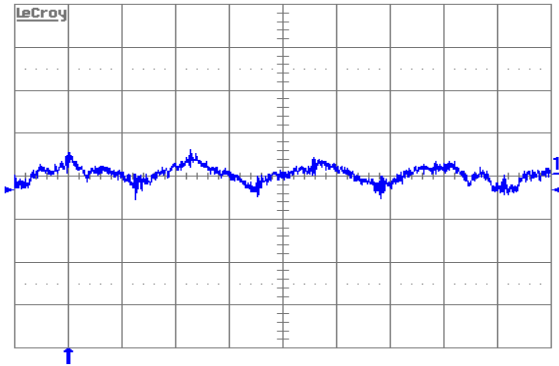

Figure 12. Input reflected-ripple current, i_s (10 mA/div.), measured through 10 μ H at the source at full rated load current and $V_{in} = 48$ V. Refer to Figure 11 for test setup. Time scale: 1 μ s/div.

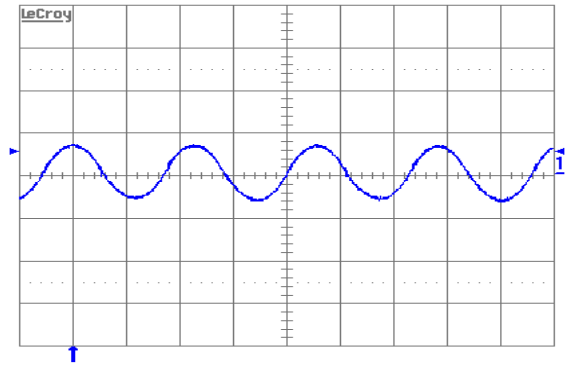

Figure 13. Input reflected ripple-current, i_c (200 mA/div.), measured at input terminals at full rated load current and $V_{in} = 48$ V. Refer to Figure 11 for test setup. Time scale: 1 μ s/div.

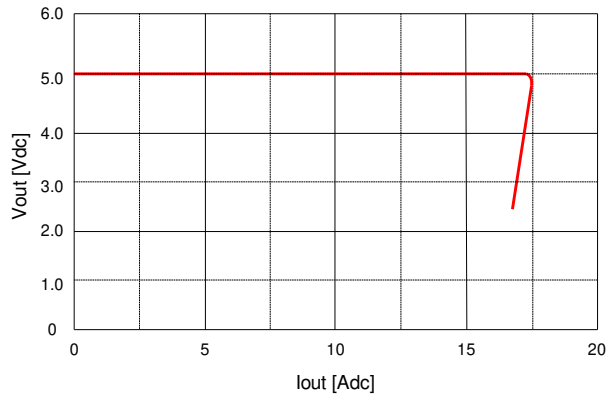

Figure 14. Output voltage vs. load current showing current limit point and converter shutdown point. Input voltage has almost no effect on current limit characteristic.

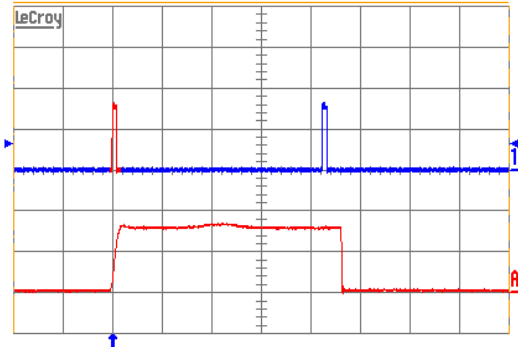
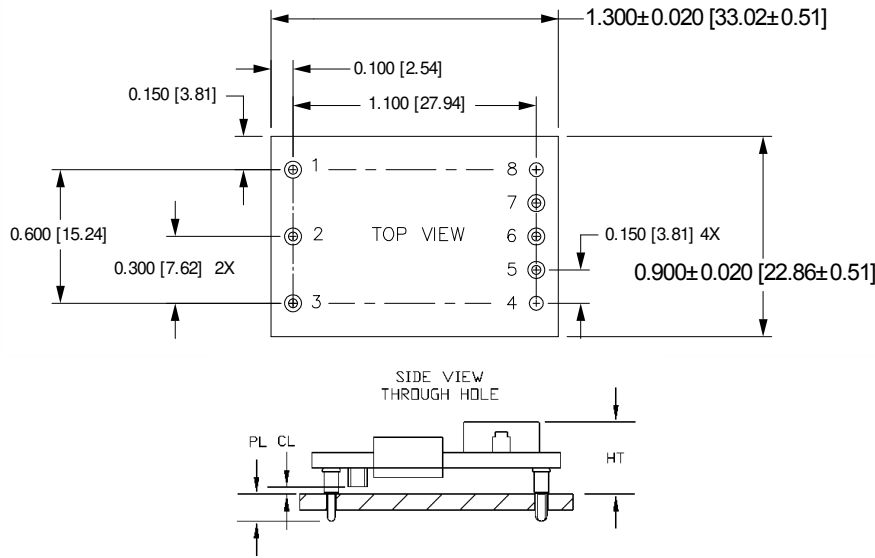

Figure 15. Load current (top trace, 10 A/div., 50 ms/div.) into a 10 m Ω short circuit during restart, at $V_{in} = 48$ V. Bottom trace (10 A/div., 1.0 ms/div.) is an expansion of the on-time portion of the top trace.

SSQE48T13050

5. MECHANICAL PARAMETERS



SSQE48T Pinout (Through-hole)

PAD / PIN CONNECTIONS	
Pad/Pin #	Function
1	Vin (+)
2	ON/OFF
3	Vin (-)
4	Vout (-)
5	SENSE(-)
6	TRIM
7	SENSE(+)
8	Vout (+)

Pin Option	PL Pin Length
	±0.005 [±0.13]
A	0.188 [4.78]
B	0.145 [3.68]
C	0.110 [2.79]

SSQE48T Platform Notes

- All dimensions are in inches [mm]
- Pins 1-3 and 5-7 are Ø 0.040" [1.02] with Ø 0.078" [1.98] shoulder
- Pins 4 and 8 are Ø 0.062" [1.57] without shoulder
- Pin material: Brass
- Pin Finish: Matte Tin over Nickel
- Converter Weight: 0.44 oz [12.3 g]

Height Option	HT (Max. Height)	CL (Min. Clearance)
	+0.000 [+0.00] -0.038 [- 0.97]	+0.016 [+0.41] -0.000 [- 0.00]
A	0.374 [9.5]	0.027 [0.7]

6. ORDERING INFORMATION

PRODUCT SERIES	INPUT VOLTAGE	MOUNTING SCHEME	RATED LOAD CURRENT	OUTPUT VOLTAGE	ON/OFF LOGIC	MAXIMUM HEIGHT [HT]	PIN LENGTH [PL]	SPECIAL FEATURES	RoHS
SSQE	48	T	13	050	-	A	B	0	G
Sixteenth Brick Format	36-75 V	T ⇒ Through-hole	13 ⇒ 13 ADC	050 ⇒ 5.0 V	N ⇒ Negative P ⇒ Positive	A ⇒ 0.374"	Through hole A ⇒ 0.188" B ⇒ 0.145" C ⇒ 0.110"	0 ⇒ No special features N ⇒ Sink current during start-up is limited to 50 mA F ⇒ 4 kV Surge capability	No Suffix ⇒ RoHS lead-solder-exemption compliant G ⇒ RoHS compliant for all six substances

The example above describes P/N SSQE48T13050-NAB0G: 36-75 V input, through-hole, 13 A @ 5.0 V output, negative enable (ON/OFF logic), pin length of 0.145", maximum height of 0.374", standard feature set, and RoHS compliant for all 6 substances. Consult factory for availability of other options.

For more information on these products consult: tech.support@psbel.com

NUCLEAR AND MEDICAL APPLICATIONS - Products are not designed or intended for use as critical components in life support systems, equipment used in hazardous environments, or nuclear control systems.

TECHNICAL REVISIONS - The appearance of products, including safety agency certifications pictured on labels, may change depending on the date manufactured. Specifications are subject to change without notice.