

# PowerMOS transistor TOPFET high side switch

PIP3201-A

## DESCRIPTION

Monolithic single channel high side protected power switch in **TOPFET2** technology assembled in a 5 pin plastic package.

## APPLICATIONS

General controller for driving lamps, motors, solenoids, heaters.

## FEATURES

- Vertical power TrenchMOS
- Low on-state resistance
- CMOS logic compatible
- Very low quiescent current
- Overtemperature protection
- Load current limiting
- Latched overload and short circuit protection
- Overvoltage and undervoltage shutdown with hysteresis
- On-state open circuit load detection
- Diagnostic status indication
- Voltage clamping for turn off of inductive loads
- ESD protection on all pins
- Reverse battery, overvoltage and transient protection

## QUICK REFERENCE DATA

SYMBOL	PARAMETER	MIN.	UNIT
$I_L$	Nominal load current (ISO)	9	A
SYMBOL	PARAMETER	MAX.	UNIT
$V_{BG}$	Continuous off-state supply voltage	50	V
$I_L$	Continuous load current	20	A
$T_j$	Continuous junction temperature	150	°C
$R_{ON}$	On-state resistance $T_j = 25^\circ\text{C}$	38	mΩ

## FUNCTIONAL BLOCK DIAGRAM

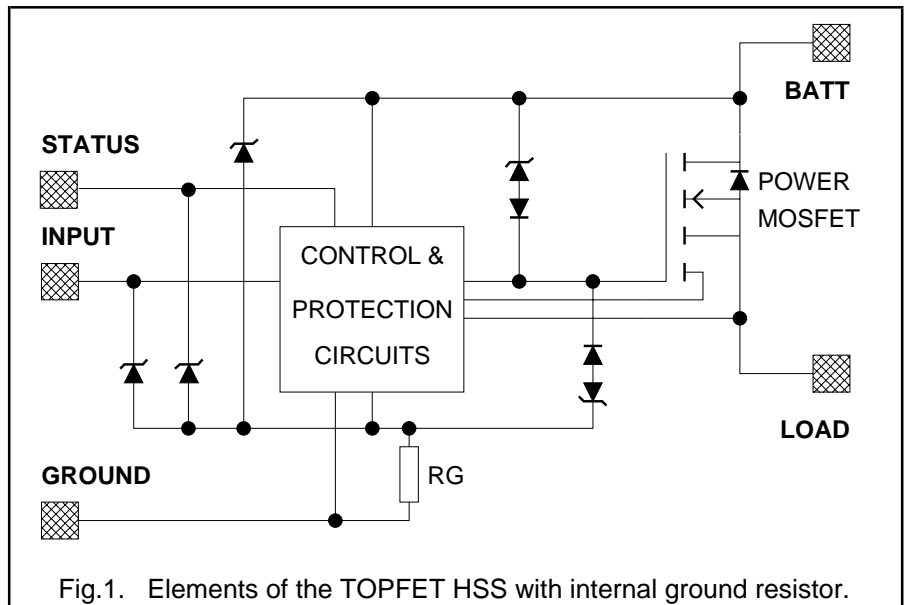

## PINNING - SOT263B-01

PIN	DESCRIPTION
1	Ground
2	Input
3	Battery (+ve supply)
4	Status
5	Load
tab	connected to pin 3

## PIN CONFIGURATION

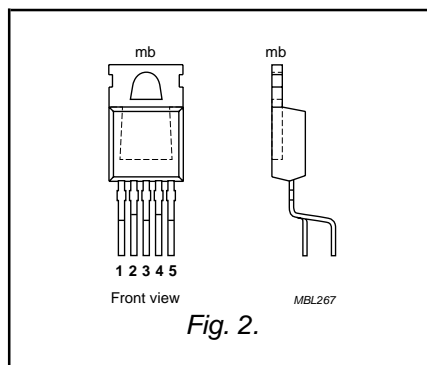

## SYMBOL

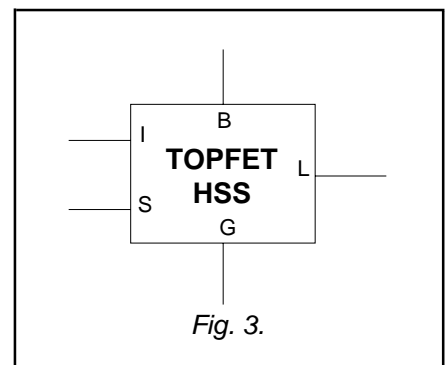

# PowerMOS transistor TOPFET high side switch

PIP3201-A

## LIMITING VALUES

Limiting values in accordance with the Absolute Maximum System (IEC 134)

SYMBOL	PARAMETER	CONDITIONS	MIN.	MAX.	UNIT
$V_{BG}$	Continuous supply voltage		0	50	V
$I_L$	Continuous load current	$T_{mb} \leq 95^\circ\text{C}$	-	20	A
$P_D$	Total power dissipation	$T_{mb} \leq 25^\circ\text{C}$	-	67	W
$T_{stg}$	Storage temperature		-55	175	$^\circ\text{C}$
$T_j$	Continuous junction temperature <sup>1</sup>		-	150	$^\circ\text{C}$
$T_{sold}$	Lead temperature	during soldering	-	260	$^\circ\text{C}$
	<b>Reverse battery voltages<sup>2</sup></b>				
$-V_{BG}$	Continuous reverse voltage		-	16	V
$-V_{BG}$	Peak reverse voltage		-	32	V
	<b>Application information</b>				
$R_I, R_S$	External resistors <sup>3</sup>	to limit input, status currents	3.2	-	k $\Omega$
	<b>Input and status</b>				
$I_I, I_S$	Continuous currents		-5	5	mA
$I_I, I_S$	Repetitive peak currents	$\delta \leq 0.1, t_p = 300 \mu\text{s}$	-50	50	mA
	<b>Inductive load clamping</b>				
$E_{BL}$	Non-repetitive clamping energy	$I_L = 10 \text{ A}, V_{BG} = 16 \text{ V}$ $T_j = 150^\circ\text{C}$ prior to turn-off	-	150	mJ

## ESD LIMITING VALUE

SYMBOL	PARAMETER	CONDITIONS	MIN.	MAX.	UNIT
$V_C$	Electrostatic discharge capacitor voltage	Human body model; $C = 250 \text{ pF}; R = 1.5 \text{ k}\Omega$	-	2	kV

## THERMAL CHARACTERISTICS

SYMBOL	PARAMETER	CONDITIONS	MIN.	TYP.	MAX.	UNIT
	<b>Thermal resistance<sup>4</sup></b>					
$R_{th\ j-mb}$	Junction to mounting base	-	-	1.52	1.86	K/W
$R_{th\ j-a}$	Junction to ambient	in free air	-	60	75	K/W

1 For normal continuous operation. A higher  $T_j$  is allowed as an overload condition but at the threshold  $T_{j(TO)}$  the over temperature trip operates to protect the switch.

2 Reverse battery voltage is allowed only with external resistors to limit the input and status currents to a safe value. The connected load must limit the reverse load current. The internal ground resistor limits the reverse battery ground current. Power is dissipated and the  $T_j$  rating must be observed.

3 To limit currents during reverse battery and transient overvoltages (positive or negative).

4 Of the output power MOS transistor.

# PowerMOS transistor TOPFET high side switch

PIP3201-A

## STATIC CHARACTERISTICS

Limits are at  $-40^{\circ}\text{C} \leq T_{\text{mb}} \leq 150^{\circ}\text{C}$  and typicals at  $T_{\text{mb}} = 25^{\circ}\text{C}$  unless otherwise stated.

SYMBOL	PARAMETER	CONDITIONS	MIN.	TYP.	MAX.	UNIT			
<b>Clamping voltages</b>									
$V_{\text{BG}}$	Battery to ground	$I_{\text{G}} = 1 \text{ mA}$	50	55	65	V			
$V_{\text{BL}}$	Battery to load	$I_{\text{L}} = I_{\text{G}} = 1 \text{ mA}$	50	55	65	V			
$-V_{\text{LG}}$	Negative load to ground	$I_{\text{L}} = 10 \text{ mA}$	18	23	28	V			
$-V_{\text{LG}}$	Negative load voltage <sup>1</sup>	$I_{\text{L}} = 10 \text{ A}; t_{\text{p}} = 300 \mu\text{s}$	20	25	30	V			
<b>Supply voltage</b>									
$V_{\text{BG}}$	Operating range <sup>2</sup>	battery to ground	5.5	-	35	V			
<b>Currents</b>									
$I_{\text{B}}$	Quiescent current <sup>3</sup>	$9 \text{ V} \leq V_{\text{BG}} \leq 16 \text{ V}$ $V_{\text{LG}} = 0 \text{ V}$ $T_{\text{mb}} = 25^{\circ}\text{C}$	-	-	20	$\mu\text{A}$			
$I_{\text{L}}$	Off-state load current <sup>4</sup>	$V_{\text{BL}} = V_{\text{BG}}$ $T_{\text{mb}} = 25^{\circ}\text{C}$	-	-	20	$\mu\text{A}$			
$I_{\text{G}}$	Operating current <sup>5</sup>	$I_{\text{L}} = 0 \text{ A}$ $T_{\text{mb}} = 25^{\circ}\text{C}$	-	2	4	mA			
$I_{\text{L}}$	Nominal load current <sup>6</sup>	$V_{\text{BL}} = 0.5 \text{ V}$ $T_{\text{mb}} = 85^{\circ}\text{C}$	9	-	-	A			
<b>Resistances</b>									
$R_{\text{ON}}$	On-state resistance	$V_{\text{BG}}$	$I_{\text{L}}$	$t_{\text{p}}^7$	$T_{\text{mb}}$				
		9 to 35 V							
$R_{\text{ON}}$	On-state resistance	6 V	10 A	300 $\mu\text{s}$	25 $^{\circ}\text{C}$				
$R_{\text{ON}}$	On-state resistance	6 V	10 A	300 $\mu\text{s}$	150 $^{\circ}\text{C}$				
$R_{\text{G}}$	Internal ground resistance	$I_{\text{G}} = 10 \text{ mA}$				95	150	190	$\Omega$

<sup>1</sup> For a high side switch, the load pin voltage goes negative with respect to ground during the turn-off of an inductive load.

<sup>2</sup> On-state resistance is increased if the supply voltage is less than 9 V.

<sup>3</sup> This is the continuous current drawn from the supply when the input is low and includes leakage current to the load.

<sup>4</sup> The measured current is in the load pin only.

<sup>5</sup> This is the continuous current drawn from the supply with no load connected, but with the input high.

<sup>6</sup> Defined as in ISO 10483-1. For comparison purposes only.

<sup>7</sup> The supply and input voltage for the  $R_{\text{ON}}$  tests are continuous. The specified pulse duration  $t_{\text{p}}$  refers only to the applied load current.

## PowerMOS transistor TOPFET high side switch

PIP3201-A

### INPUT CHARACTERISTICS

$9\text{ V} \leq V_{\text{BG}} \leq 16\text{ V}$ . Limits are at  $-40^\circ\text{C} \leq T_{\text{mb}} \leq 150^\circ\text{C}$  and typicals at  $T_{\text{mb}} = 25^\circ\text{C}$  unless otherwise stated.

SYMBOL	PARAMETER	CONDITIONS	MIN.	TYP.	MAX.	UNIT
$I_{\text{I}}$	Input current	$V_{\text{IG}} = 5\text{ V}$	20	90	160	$\mu\text{A}$
$V_{\text{IG}}$	Input clamping voltage	$I_{\text{I}} = 200\ \mu\text{A}$	5.5	7	8.5	V
$V_{\text{IG(ON)}}$	Input turn-on threshold voltage		-	2.4	3	V
$V_{\text{IG(OFF)}}$	Input turn-off threshold voltage		1.5	2.1	-	V
$\Delta V_{\text{IG}}$	Input turn-on hysteresis		-	0.3	-	V
$I_{\text{I(ON)}}$	Input turn-on current	$V_{\text{IG}} = 3\text{ V}$	-	-	100	$\mu\text{A}$
$I_{\text{I(OFF)}}$	Input turn-off current	$V_{\text{IG}} = 1.5\text{ V}$	10	-	-	$\mu\text{A}$

### STATUS CHARACTERISTICS

The status output is an open drain transistor, and requires an external pull-up circuit to indicate a logic high. Limits are at  $-40^\circ\text{C} \leq T_{\text{mb}} \leq 150^\circ\text{C}$  and typicals at  $T_{\text{mb}} = 25^\circ\text{C}$  unless otherwise stated. Refer to TRUTH TABLE.

SYMBOL	PARAMETER	CONDITIONS	MIN.	TYP.	MAX.	UNIT
$V_{\text{SG}}$	Status clamping voltage	$I_{\text{S}} = 100\ \mu\text{A}$	5.5	7	8.5	V
$V_{\text{SG}}$	Status low voltage	$I_{\text{S}} = 100\ \mu\text{A}$	-	-	1	V
		$T_{\text{mb}} = 25^\circ\text{C}$	-	0.7	0.8	V
$I_{\text{S}}$	Status leakage current	$V_{\text{SG}} = 5\text{ V}$	-	-	15	$\mu\text{A}$
		$T_{\text{mb}} = 25^\circ\text{C}$	-	0.1	1	$\mu\text{A}$
$I_{\text{S}}$	Status saturation current <sup>1</sup>	$V_{\text{SG}} = 5\text{ V}$	2	7	12	mA
$R_{\text{S}}$	<b>Application information</b> External pull-up resistor		-	47	-	k $\Omega$

### OPEN CIRCUIT DETECTION CHARACTERISTICS

An open circuit load can be detected in the on-state. Refer to TRUTH TABLE. Limits are at  $-40^\circ\text{C} \leq T_{\text{mb}} \leq 150^\circ\text{C}$  and typical is at  $T_{\text{mb}} = 25^\circ\text{C}$ .

SYMBOL	PARAMETER	CONDITIONS	MIN.	TYP.	MAX.	UNIT
	<b>Open circuit detection</b>	$9\text{ V} \leq V_{\text{BG}} \leq 35\text{ V}$				
$I_{\text{L(TO)}}$	Low current detect threshold		0.24	-	1.6	A
		$T_{\text{j}} = 25^\circ\text{C}$	0.4	0.8	1.2	A
$\Delta I_{\text{L(TO)}}$	Hysteresis		-	0.16	-	A

<sup>1</sup> In a fault condition with the pull-up resistor short circuited while the status transistor is conducting. This condition should be avoided in order to prevent possible interference with normal operation of the device.

# PowerMOS transistor TOPFET high side switch

PIP3201-A

## UNDERVOLTAGE & OVERVOLTAGE CHARACTERISTICS

Limits are at  $-40^{\circ}\text{C} \leq T_{\text{mb}} \leq 150^{\circ}\text{C}$  and typicals at  $T_{\text{mb}} = 25^{\circ}\text{C}$ . Refer to TRUTH TABLE.

SYMBOL	PARAMETER	CONDITIONS	MIN.	TYP.	MAX.	UNIT
	<b>Undervoltage</b>					
$V_{\text{BG(UV)}}$	Low supply threshold voltage <sup>1</sup>		2	4.2	5.5	V
$\Delta V_{\text{BG(UV)}}$	Hysteresis		-	0.5	-	V
	<b>Overvoltage</b>					
$V_{\text{BG(OV)}}$	High supply threshold voltage <sup>2</sup>		40	45	50	V
$\Delta V_{\text{BG(OV)}}$	Hysteresis		-	1	-	V

## TRUTH TABLE

INPUT	ABNORMAL CONDITIONS DETECTED					LOAD OUTPUT	STATUS	DESCRIPTION
	SUPPLY		LOAD					
	UV	OV	LC	SC	OT			
L	X	X	X	X	X	OFF	H	off
H	0	0	0	0	0	ON	H	on & normal
H	0	0	1	0	0	ON	L	on & low current detect
H	1	0	X	X	X	OFF	H	supply undervoltage lockout
H	0	1	X	0	0	OFF	H	supply overvoltage shutdown
H	0	0	0	1	X	OFF	L	SC tripped
H	0	0	0	0	1	OFF	L	OT shutdown <sup>3</sup>

## KEY TO ABBREVIATIONS

L	logic low	UV	undervoltage
H	logic high	OV	overvoltage
X	don't care	LC	low current or open circuit load
0	condition not present	SC	short circuit
1	condition present	OT	overtemperature

<sup>1</sup> Undervoltage sensor causes the device to switch off and reset.

<sup>2</sup> Overvoltage sensor causes the device to switch off to protect its load.

<sup>3</sup> The status will continue to indicate OT (even if the input goes low) until the device cools below the reset threshold. Refer to OVERLOAD PROTECTION CHARACTERISTICS.

## PowerMOS transistor TOPFET high side switch

PIP3201-A

### OVERLOAD PROTECTION CHARACTERISTICS

$5.5 \text{ V} \leq V_{\text{BG}} \leq 35 \text{ V}$ , limits are at  $-40^\circ\text{C} \leq T_{\text{mb}} \leq 150^\circ\text{C}$  and typicals at  $T_{\text{mb}} = 25^\circ\text{C}$  unless otherwise stated.  
Refer to TRUTH TABLE.

SYMBOL	PARAMETER	CONDITIONS	MIN.	TYP.	MAX.	UNIT
$I_{\text{L(lim)}}$	<b>Overload protection</b> Load current limiting	$V_{\text{BL}} = V_{\text{BG}}$ $V_{\text{BG}} \geq 9 \text{ V}$	34	45	64	A
$V_{\text{BL(TO)}}$	<b>Short circuit load protection</b> Battery load threshold voltage <sup>1</sup>	$V_{\text{BG}} = 16 \text{ V}$ $V_{\text{BG}} = 35 \text{ V}$	8 15	10 20	12 25	V V
$t_{\text{d sc}}$	Response time <sup>2</sup>	$V_{\text{BL}} > V_{\text{BL(TO)}}$	-	180	250	$\mu\text{s}$
$T_{\text{j(TO)}}$	<b>Overtemperature protection</b> Threshold junction temperature <sup>3</sup>		150	170	190	$^\circ\text{C}$
$\Delta T_{\text{j(TO)}}$	Hysteresis		-	10	-	$^\circ\text{C}$

### SWITCHING CHARACTERISTICS

$T_{\text{mb}} = 25^\circ\text{C}$ ,  $V_{\text{BG}} = 13 \text{ V}$ , for resistive load  $R_{\text{L}} = 13 \Omega$ .

SYMBOL	PARAMETER	CONDITIONS	MIN.	TYP.	MAX.	UNIT
$t_{\text{d on}}$	<b>During turn-on</b> Delay time	from input going high to 10% $V_{\text{L}}$	-	40	60	$\mu\text{s}$
$dV/dt_{\text{on}}$	Rate of rise of load voltage	30% to 70% $V_{\text{L}}$	-	0.35	1	V/ $\mu\text{s}$
$t_{\text{on}}$	Total switching time	to 90% $V_{\text{L}}$	-	140	200	$\mu\text{s}$
$t_{\text{d off}}$	<b>During turn-off</b> Delay time	from input going low to 90% $V_{\text{L}}$	-	55	80	$\mu\text{s}$
$dV/dt_{\text{off}}$	Rate of fall of load voltage	70% to 30% $V_{\text{L}}$	-	0.6	1	V/ $\mu\text{s}$
$t_{\text{off}}$	Total switching time	to 10% $V_{\text{L}}$	-	85	120	$\mu\text{s}$

### CAPACITANCES

$T_{\text{mb}} = 25^\circ\text{C}$ ;  $f = 1 \text{ MHz}$ ;  $V_{\text{IG}} = 0 \text{ V}$ . *designed in parameters.*

SYMBOL	PARAMETER	CONDITIONS	MIN.	TYP.	MAX.	UNIT
$C_{\text{ig}}$	Input capacitance	$V_{\text{BG}} = 13 \text{ V}$	-	15	20	pF
$C_{\text{bl}}$	Output capacitance	$V_{\text{BL}} = 13 \text{ V}$	-	250	350	pF
$C_{\text{sg}}$	Status capacitance	$V_{\text{SG}} = 5 \text{ V}$	-	11	15	pF

1 The battery to load threshold voltage for short circuit protection is proportional to the battery supply voltage. After short circuit protection has operated, the input voltage must be toggled low for the switch to resume normal operation.

2 Measured from when the input goes high.

3 After cooling below the reset temperature the switch will resume normal operation.

PowerMOS transistor  
TOPFET high side switch

PIP3201-A

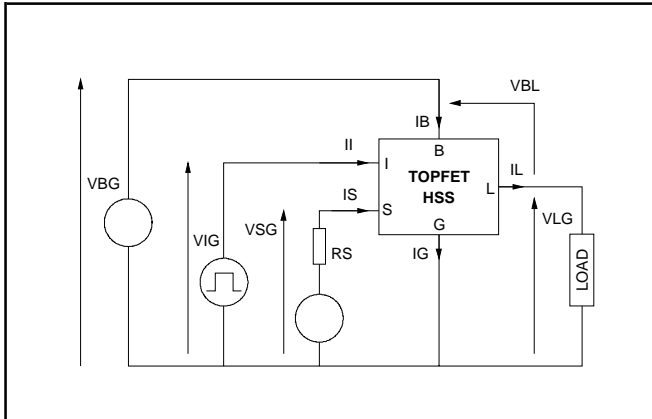

Fig.4. High side switch measurements schematic. (current and voltage conventions)

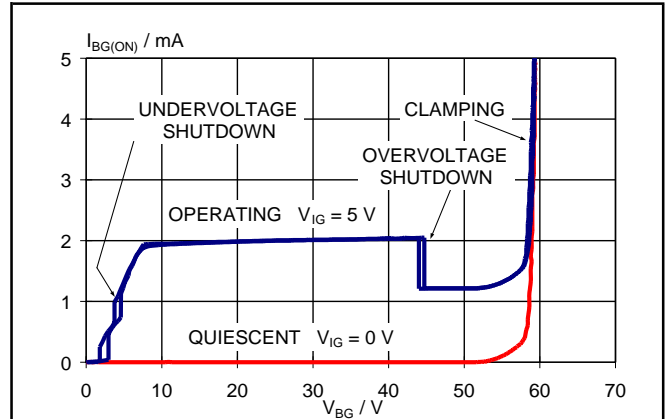

Fig.7. Typical supply characteristics, 25 °C.  
 $I_G = f(V_{BG})$ ; parameter  $V_{IG}$

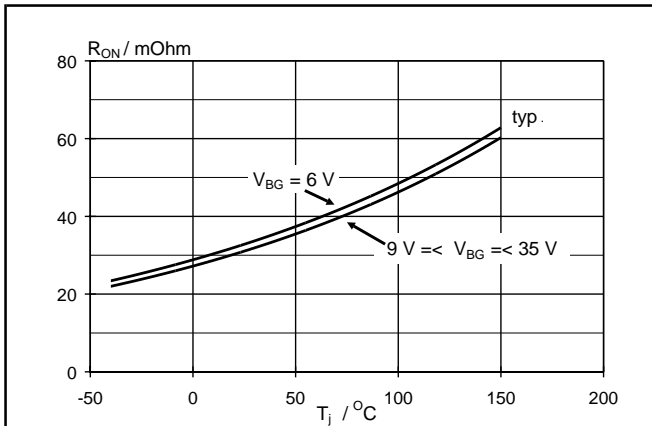

Fig.5. Typical on-state resistance,  $t_p = 300 \mu s$ .  
 $R_{ON} = f(T_j)$ ; parameter  $V_{BG}$ ; condition  $I_L = 10 A$

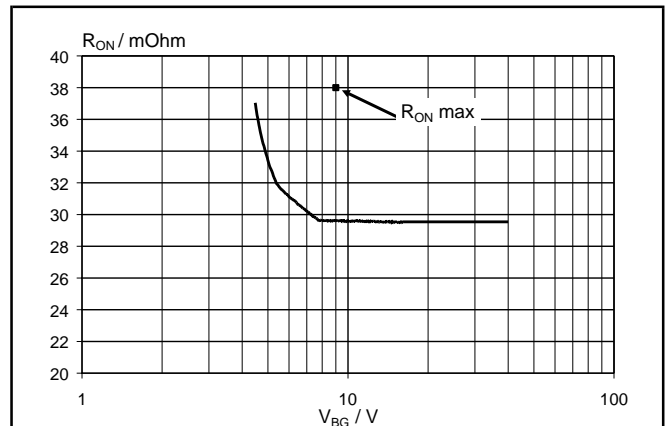

Fig.8. Typical on-state resistance,  $T_j = 25 \text{ }^\circ\text{C}$ .  
 $R_{ON} = f(V_{BG})$ ; condition  $I_L = 10 A$ ;  $t_p = 300 \mu s$

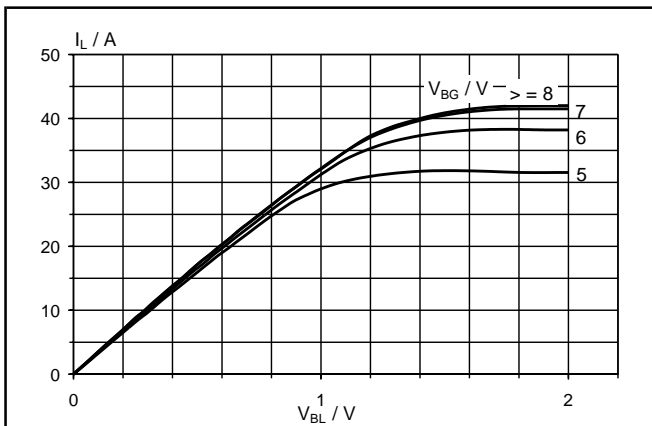

Fig.6. Typical on-state characteristics,  $T_j = 25 \text{ }^\circ\text{C}$ .  
 $I_L = f(T_j)$ ; parameter  $V_{BG}$ ;  $t_p = 250 \mu s$

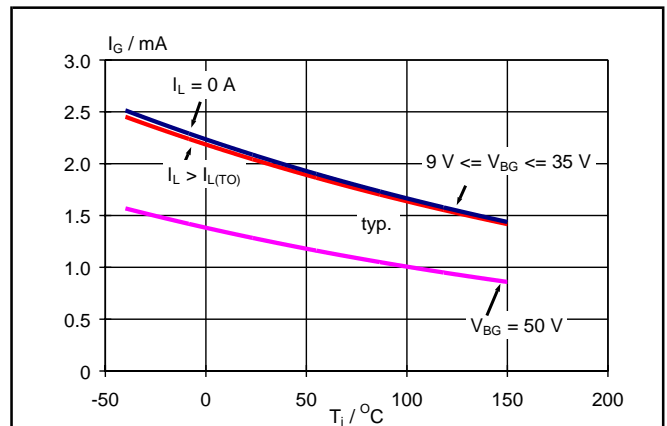

Fig.9. Typical operating supply current.  
 $I_G = f(T_j)$ ; parameters  $I_L$ ,  $V_{BG}$ ; condition  $V_{IG} = 5 V$

PowerMOS transistor  
TOPFET high side switch

PIP3201-A

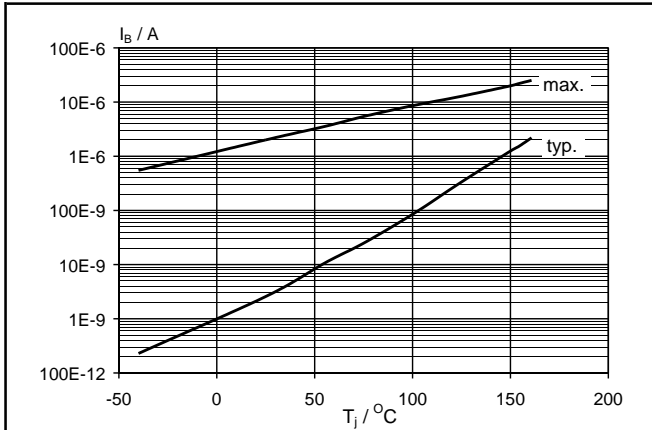

Fig. 10. Typical supply quiescent current.  
 $I_B = f(T_j)$ ; condition  $V_{BG} = 16\text{ V}$ ,  $V_{IG} = 0\text{ V}$ ,  $V_{LG} = 0\text{ V}$

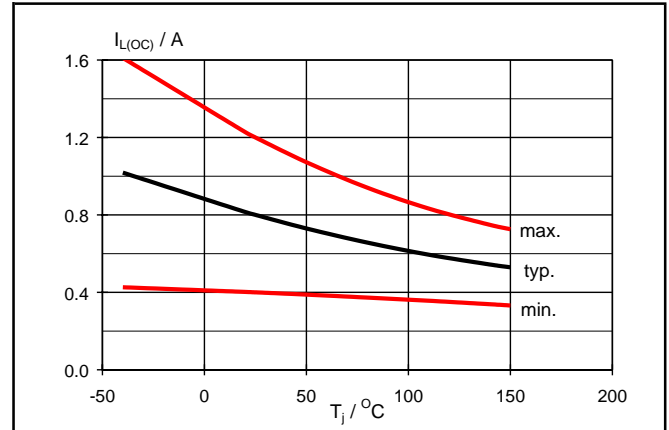

Fig. 13. Low load current detection threshold.  
 $I_{L(OC)} = f(T_j)$ ; conditions  $V_{IG} = 5\text{ V}$ ;  $V_{BG} \geq 9\text{ V}$

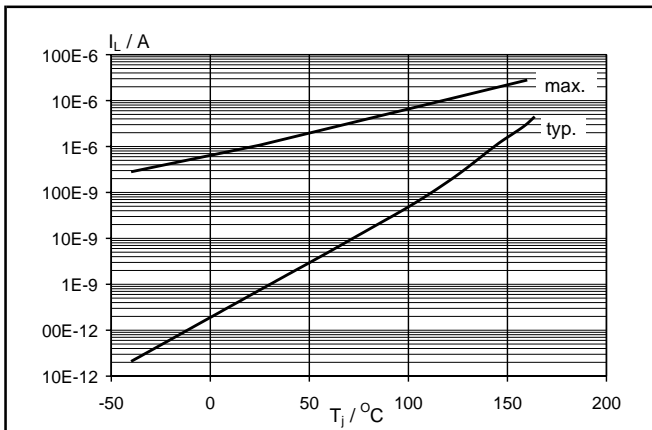

Fig. 11. Typical off-state leakage current.  
 $I_L = f(T_j)$ ; conditions  $V_{BL} = 16\text{ V} = V_{BG}$ ,  $V_{IG} = 0\text{ V}$ .

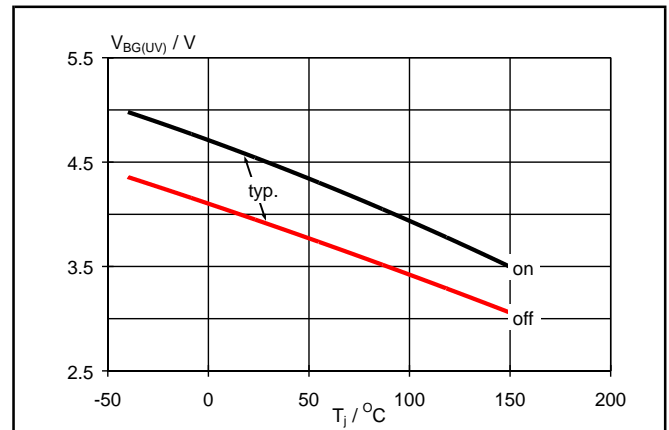

Fig. 14. Supply undervoltage thresholds.  
 $V_{BG(UV)} = f(T_j)$ ; conditions  $V_{IG} = 5\text{ V}$ ;  $V_{BL} \leq 2\text{ V}$

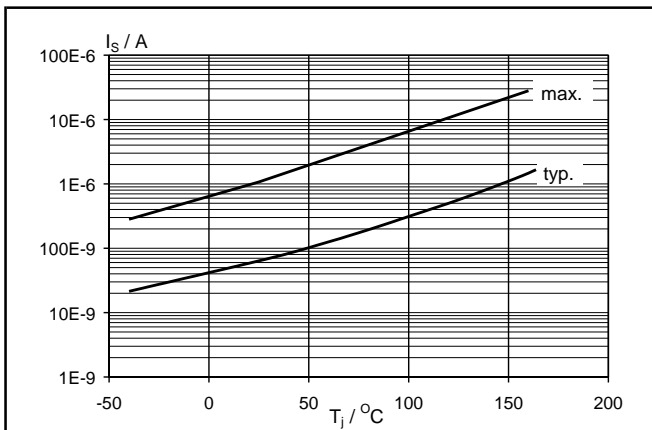

Fig. 12. Status leakage current.  
 $I_S = f(T_j)$ ; conditions  $V_{SG} = 5\text{ V}$ ,  $V_{IG} = V_{BG} = 0\text{ V}$

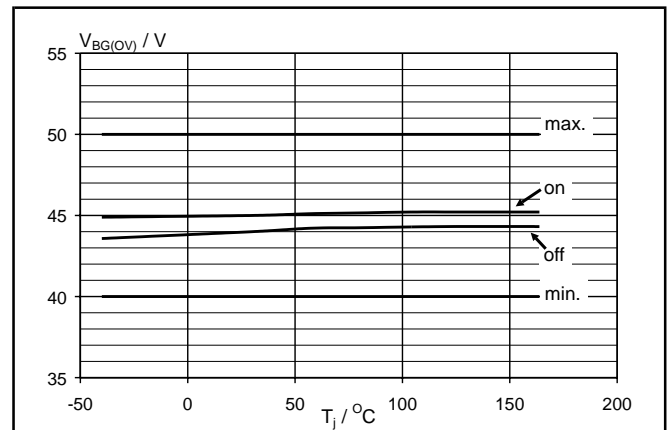
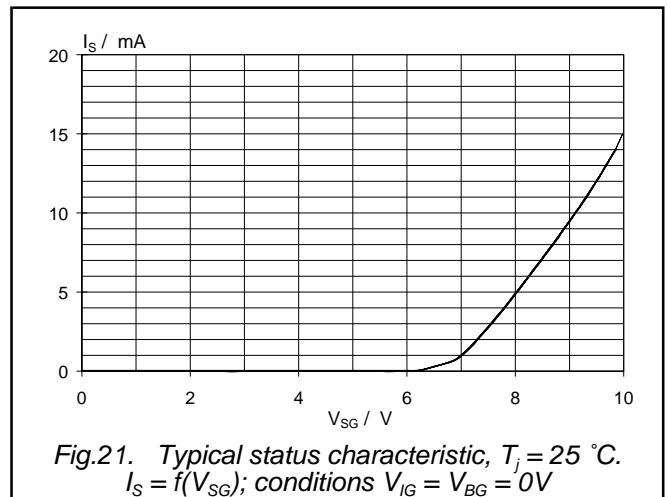
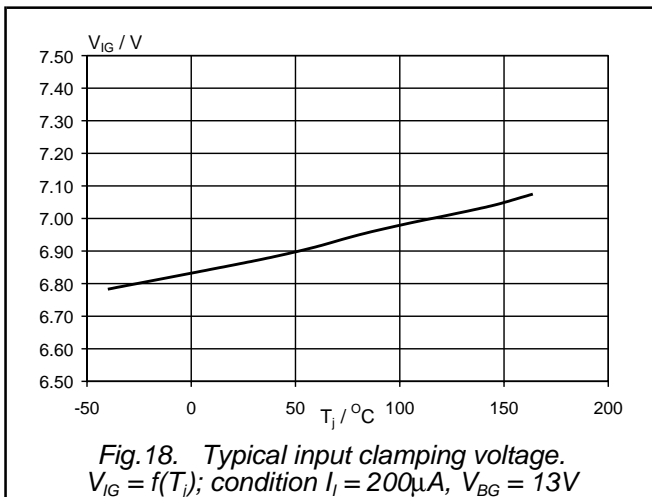
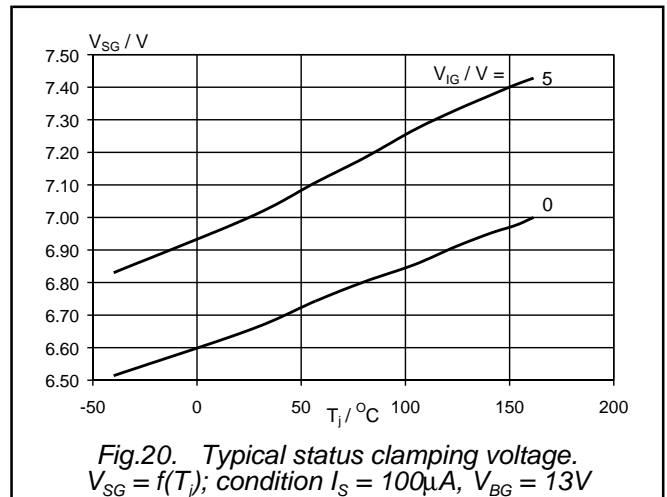
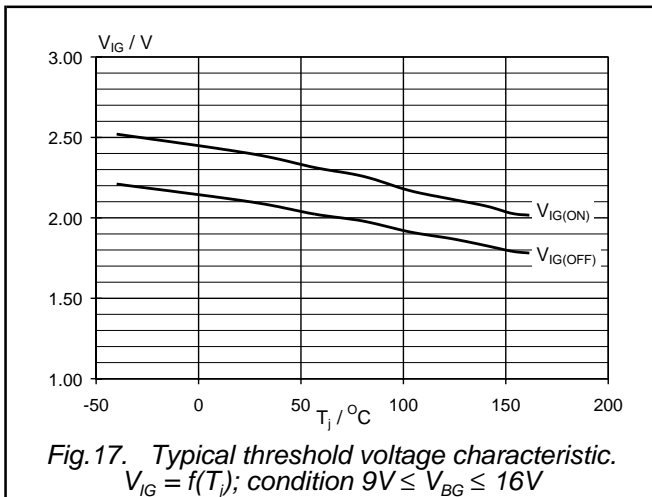
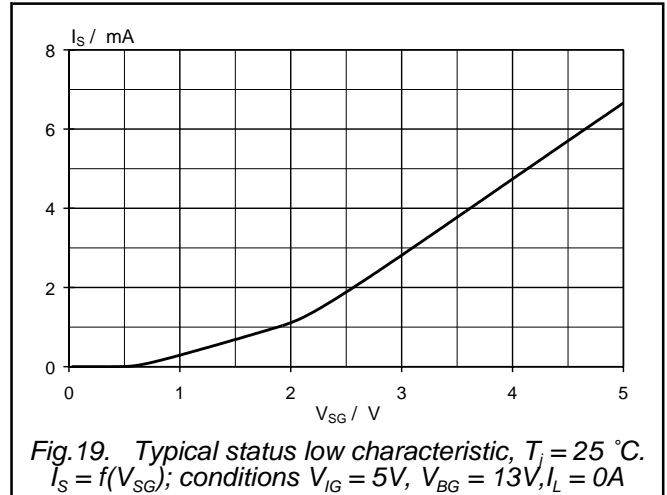
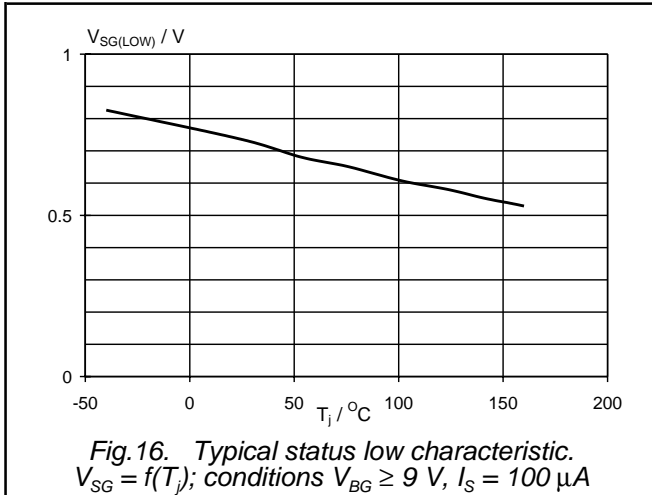

Fig. 15. Supply overvoltage thresholds.  
 $V_{BG(OV)} = f(T_j)$ ; conditions  $V_{IG} = 5\text{ V}$ ;  $I_L = 100\text{ mA}$



PowerMOS transistor  
TOPFET high side switch

PIP3201-A



PowerMOS transistor  
TOPFET high side switch

PIP3201-A

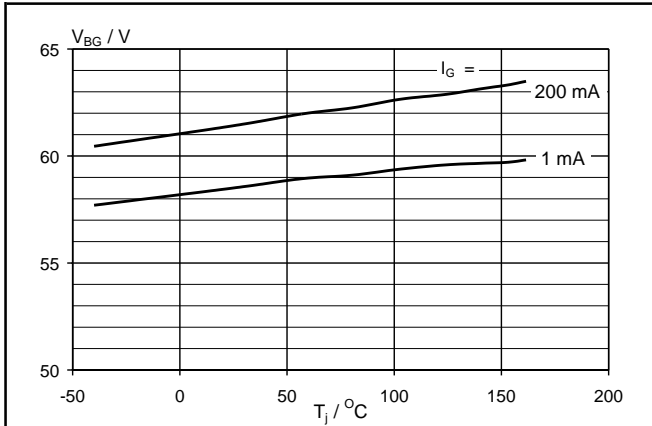

Fig.22. Typical battery to ground clamping voltage.  
 $V_{BG} = f(T_j)$ ; parameter  $I_G$

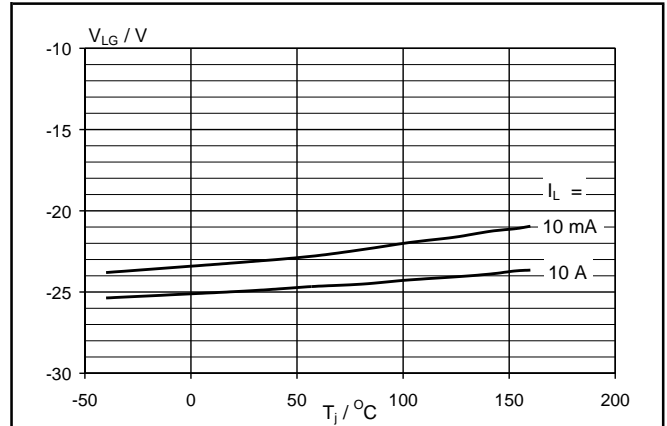

Fig.25. Typical negative load clamping voltage.  
 $V_{LG} = f(T_j)$ ; parameter  $I_L$ ; condition  $V_{IG} = 0V$

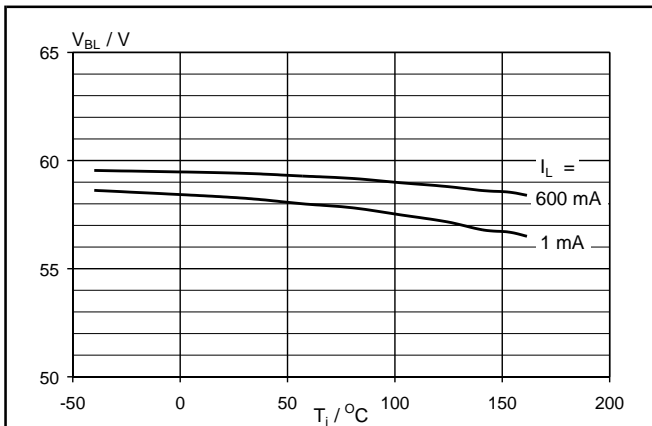

Fig.23. Typical battery to load clamping voltage.  
 $V_{BL} = f(T_j)$ ; parameter  $I_L$ ; condition  $I_G = 10mA$

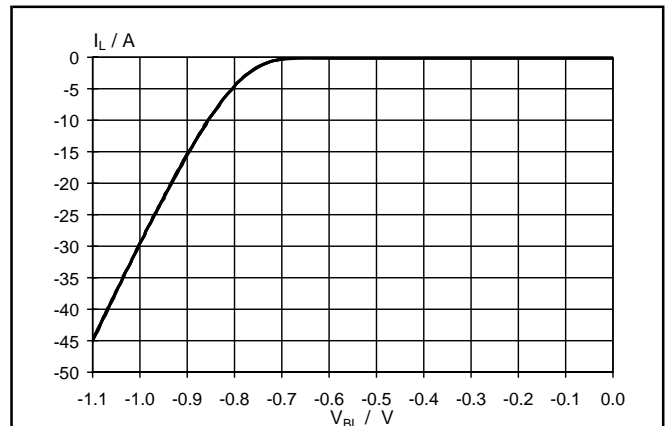

Fig.26. Typical reverse diode characteristic.  
 $I_L = f(V_{BL})$ ; conditions  $V_{IG} = 0V$ ,  $T_j = 25^{\circ}C$

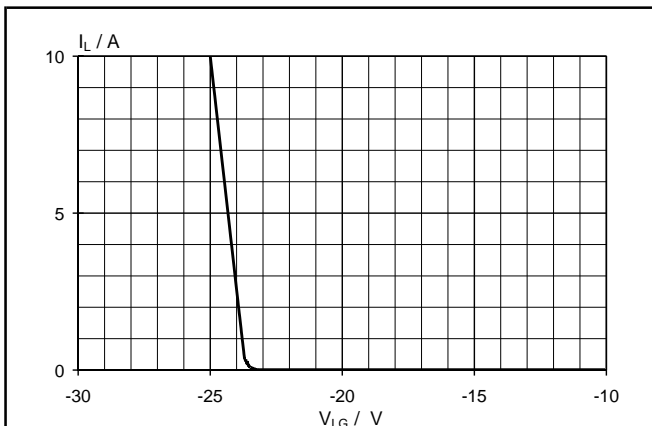

Fig.24. Typical negative load clamping.  
 $I_L = f(V_{LG})$ ; conditions  $V_{IG} = 0V$ ,  $T_j = 25^{\circ}C$

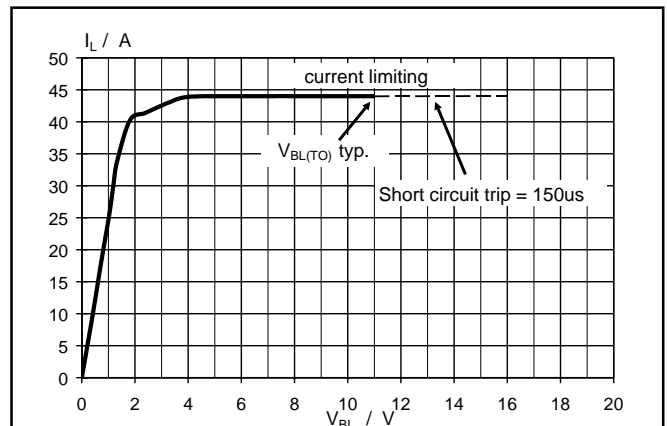
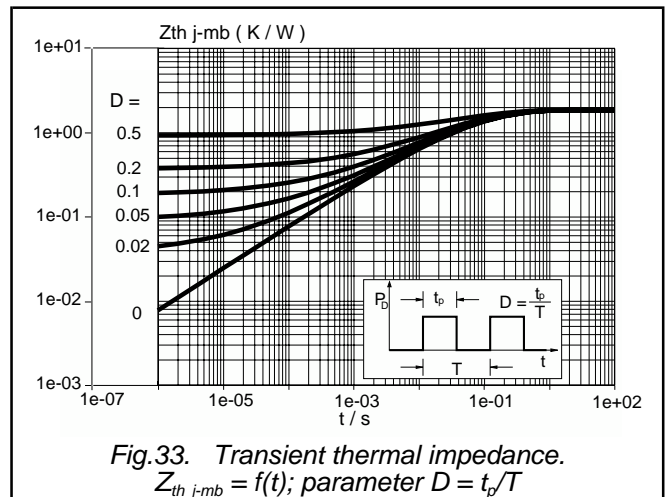
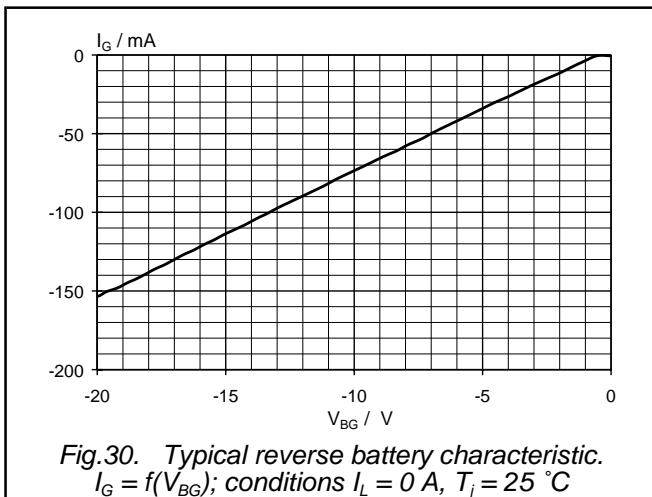
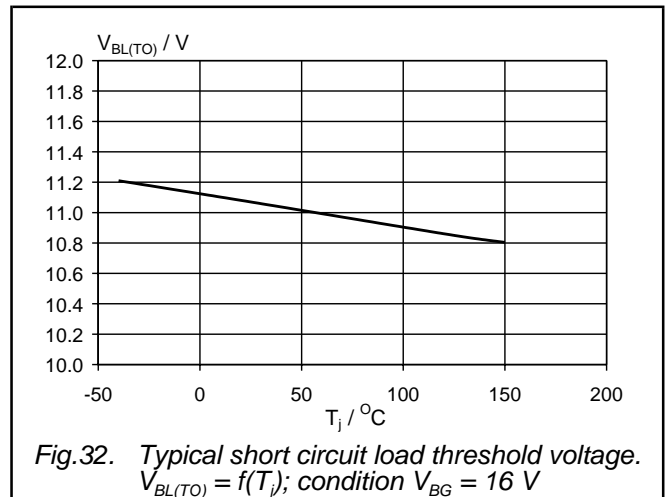
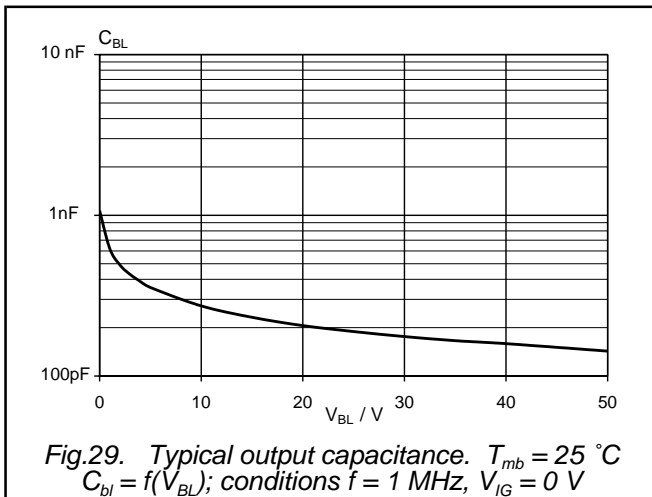
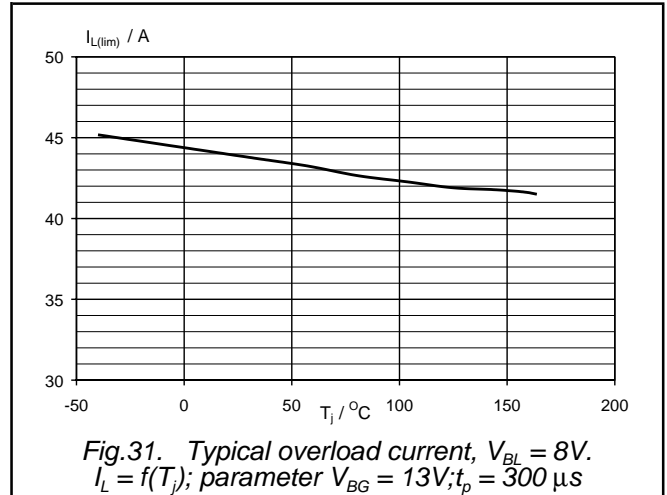
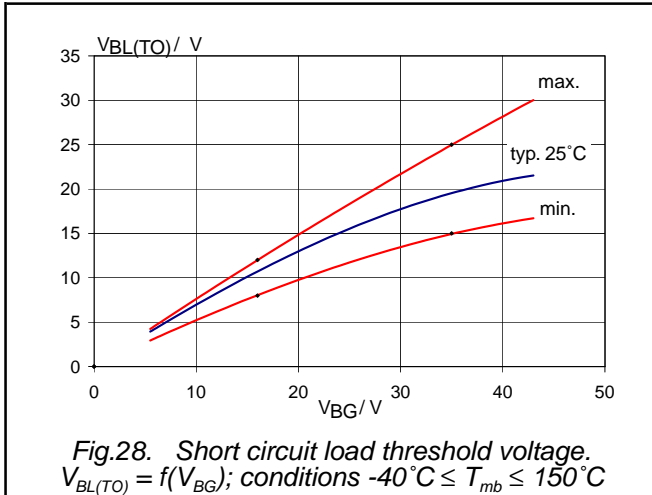

Fig.27. Typical overload characteristic,  $T_{mb} = 25^{\circ}C$ .  
 $I_L = f(V_{BL})$ ; condition  $V_{BG} = 16V$ ; parameter  $t_p$

PowerMOS transistor  
TOPFET high side switch

PIP3201-A



PowerMOS transistor  
TOPFET high side switch

PIP3201-A

MECHANICAL DATA

Plastic single-ended package; heatsink mounted; 1 mounting hole;  
5-lead TO-220 lead form option

SOT263B-01

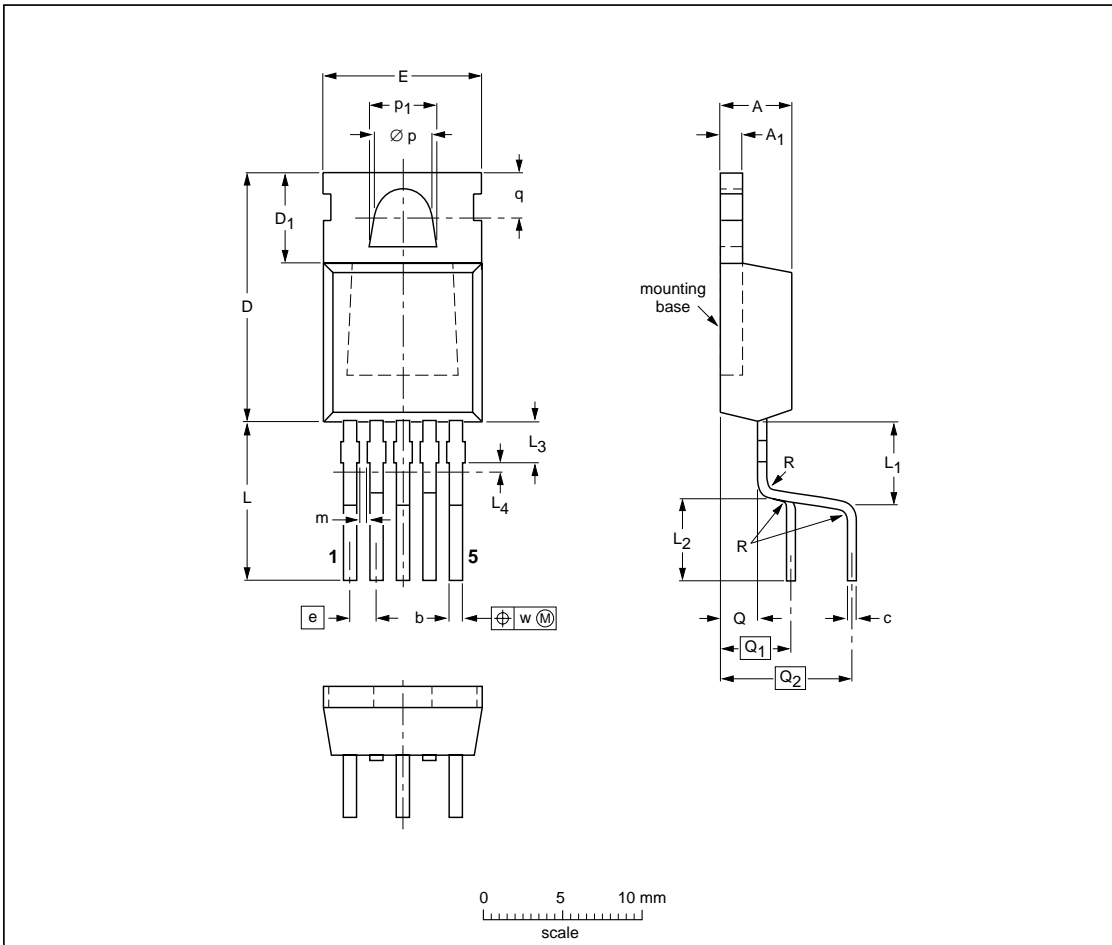

DIMENSIONS (mm are the original dimensions)

UNIT	A	A <sub>1</sub>	b	c	D	D <sub>1</sub>	E	e	L	L <sub>1</sub>	L <sub>2</sub>	L <sub>3</sub> ( <sup>1</sup> )	L <sub>4</sub> ( <sup>2</sup> ) max.	m	∅ p	p <sub>1</sub>	q	Q	Q <sub>1</sub>	Q <sub>2</sub>	R	w
mm	4.5 4.1	1.39 1.27	0.85 0.70	0.7 0.4	15.8 15.2	6.4 5.9	10.3 9.7	1.7	9.8 9.7	5.9 5.3	5.2 5.0	2.4 1.6	0.5	0.8 0.6	3.8 3.6	4.3 4.1	3.0 2.7	2.0	4.5	8.2	0.5	0.4

Notes

1. Terminal dimensions are uncontrolled in this zone.
2. Positional accuracy of the terminals is controlled in this zone.

OUTLINE VERSION	REFERENCES			EUROPEAN PROJECTION	ISSUE DATE
	IEC	JEDEC	EIAJ		
SOT263B-01		5-lead (option) TO-220			01-01-11

Fig.34. SOT263B package<sup>1</sup> leadform 263B-01, pin 3 connected to mounting base.

<sup>1</sup> Refer to mounting instructions for TO220 envelopes. Epoxy meets UL94 VO at 1/8". Net mass: 2 g

# PowerMOS transistor TOPFET high side switch

PIP3201-A

## DEFINITIONS

DATA SHEET STATUS		
DATA SHEET STATUS <sup>1</sup>	PRODUCT STATUS <sup>2</sup>	DEFINITIONS
Objective data	Development	This data sheet contains data from the objective specification for product development. Philips Semiconductors reserves the right to change the specification in any manner without notice
Preliminary data	Qualification	This data sheet contains data from the preliminary specification. Supplementary data will be published at a later date. Philips Semiconductors reserves the right to change the specification without notice, in order to improve the design and supply the best possible product
Product data	Production	This data sheet contains data from the product specification. Philips Semiconductors reserves the right to make changes at any time in order to improve the design, manufacturing and supply. Changes will be communicated according to the Customer Product/Process Change Notification (CPCN) procedure SNW-SQ-650A
<b>Limiting values</b>		
Limiting values are given in accordance with the Absolute Maximum Rating System (IEC 134). Stress above one or more of the limiting values may cause permanent damage to the device. These are stress ratings only and operation of the device at these or at any other conditions above those given in the Characteristics sections of this specification is not implied. Exposure to limiting values for extended periods may affect device reliability.		
<b>Application information</b>		
Where application information is given, it is advisory and does not form part of the specification.		
© Philips Electronics N.V. 2001		
All rights are reserved. Reproduction in whole or in part is prohibited without the prior written consent of the copyright owner.		
The information presented in this document does not form part of any quotation or contract, it is believed to be accurate and reliable and may be changed without notice. No liability will be accepted by the publisher for any consequence of its use. Publication thereof does not convey nor imply any license under patent or other industrial or intellectual property rights.		

## LIFE SUPPORT APPLICATIONS

These products are not designed for use in life support appliances, devices or systems where malfunction of these products can be reasonably expected to result in personal injury. Philips customers using or selling these products for use in such applications do so at their own risk and agree to fully indemnify Philips for any damages resulting from such improper use or sale.

<sup>1</sup> Please consult the most recently issued datasheet before initiating or completing a design.

<sup>2</sup> The product status of the device(s) described in this datasheet may have changed since this datasheet was published. The latest information is available on the Internet at URL <http://www.semiconductors.philips.com>.