

CMXSH2-4LS

**SURFACE MOUNT SILICON
DUAL PAIR, IN-SERIES
LOW V_F SCHOTTKY DIODE**



www.centrasemi.com

DESCRIPTION:

The CENTRAL SEMICONDUCTOR CMXSH2-4LS consists of dual, in-series pairs of low V_F silicon Schottky diodes, and is manufactured in an SOT-26 surface mount package. This device can be configured as a bridge rectifier using the optional mounting pad configuration on the following page.

MARKING CODE: CXS4L**MAXIMUM RATINGS:** ($T_A=25^\circ\text{C}$)

Peak Repetitive Reverse Voltage
Continuous Forward Current
Peak Repetitive Forward Current
Peak Forward Surge Current, $t_p=10\text{ms}$
Power Dissipation
Operating and Storage Junction Temperature
Thermal Resistance

SYMBOL		UNITS
V_{RRM}	40	V
I_F	200	mA
I_{FRM}	350	mA
I_{FSM}	1.0	A
P_D	350	mW
T_J, T_{stg}	-65 to +150	$^\circ\text{C}$
θ_{JA}	357	$^\circ\text{C/W}$

ELECTRICAL CHARACTERISTICS PER DIODE: ($T_A=25^\circ\text{C}$ unless otherwise noted)

SYMBOL	TEST CONDITIONS	MIN	TYP	MAX	UNIT
I_R	$V_R=20\text{V}$		11	50	μA
BV_R	$I_R=100\mu\text{A}$	40	53		V
V_F	$I_F=10\text{mA}$		0.24	0.325	V
V_F	$I_F=100\text{mA}$		0.35	0.4	V
V_F	$I_F=200\text{mA}$		0.42	0.5	V
C_J	$V_R=4.0\text{V}, f=1.0\text{MHz}$		8.5	10	pF
t_{rr}	$I_F=I_R=30\text{mA}, I_{rr}=3.0\text{mA}, R_L=100\Omega$		4.0	5.0	ns

CMXSH2-4LS
SURFACE MOUNT SILICON
DUAL PAIR, IN-SERIES
LOW V_F SCHOTTKY DIODE



SOT 26 CASE - MECHANICAL OUTLINE

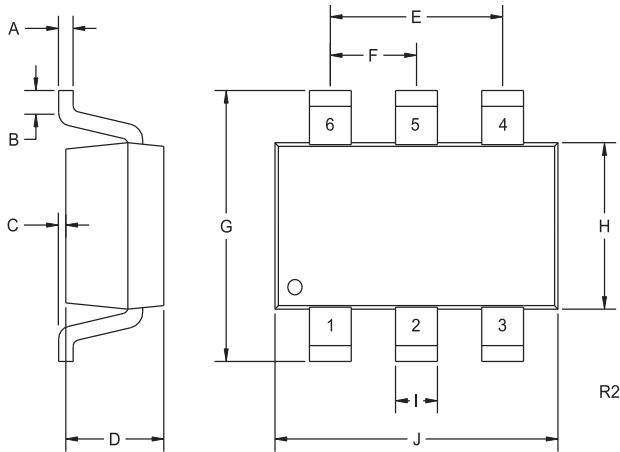

SYMBOL	DIMENSIONS			
	INCHES		MILLIMETERS	
	MIN	MAX	MIN	MAX
A	0.004	0.007	0.11	0.19
B	0.016	-	0.40	-
C	-	0.004	-	0.10
D	0.039	0.047	1.00	1.20
E	0.074	0.075	1.88	1.92
F	0.037	0.038	0.93	0.97
G	0.102	0.118	2.60	3.00
H	0.059	0.067	1.50	1.70
I	0.016		0.41	
J	0.110	0.118	2.80	3.00

SOT-26 (REV: R2)

PIN CONFIGURATION

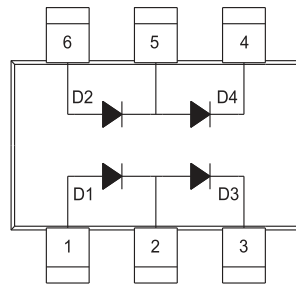

LEAD CODE:

- 1) Anode D1
- 2) Cathode D1, Anode D3
- 3) Cathode D3
- 4) Cathode D4
- 5) Anode D4, Cathode D2
- 6) Anode D2

MARKING CODE: CXS4L

OPTIONAL MOUNTING PADS
For Bridge Rectifier Configuration
 (Dimensions in mm)

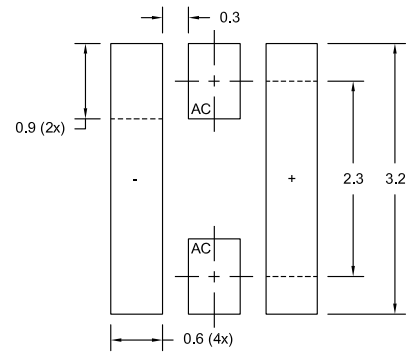

R3 (13-November 2015)

CMXSH2-4LS

SURFACE MOUNT SILICON
DUAL PAIR, IN-SERIES
LOW V_F SCHOTTKY DIODE



TYPICAL ELECTRICAL CHARACTERISTICS

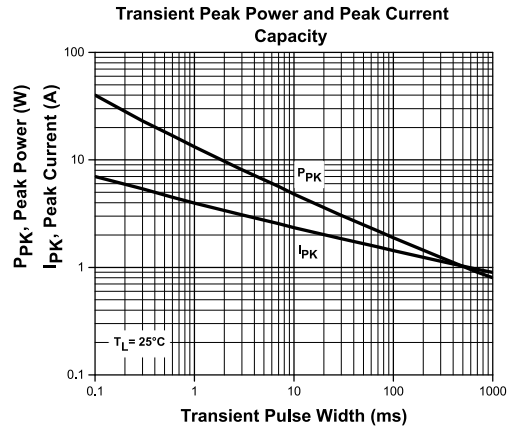
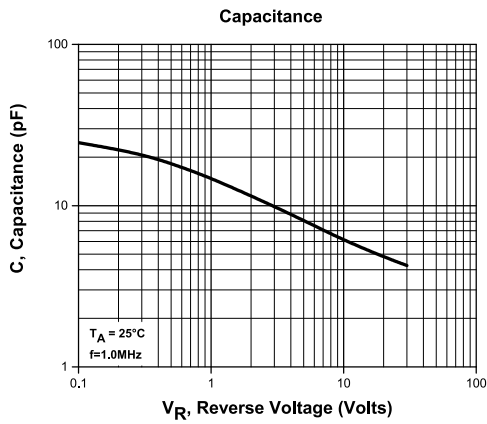
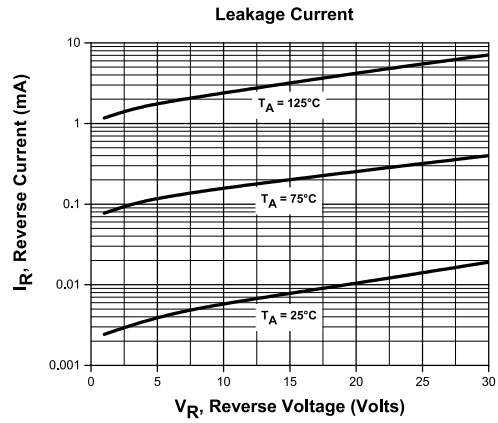
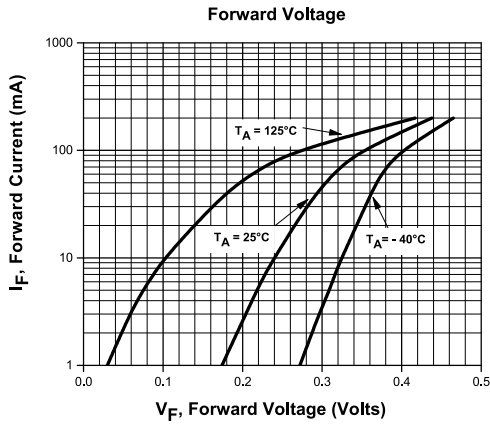

R3 (13-November 2015)

CMXSH2-4LS

SURFACE MOUNT SILICON
DUAL PAIR, IN-SERIES
LOW V_F SCHOTTKY DIODE



TYPICAL ELECTRICAL CHARACTERISTICS

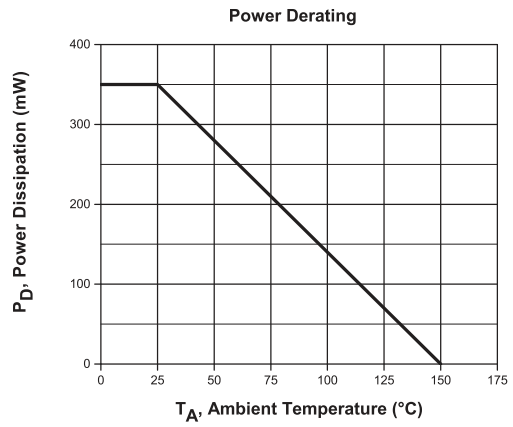
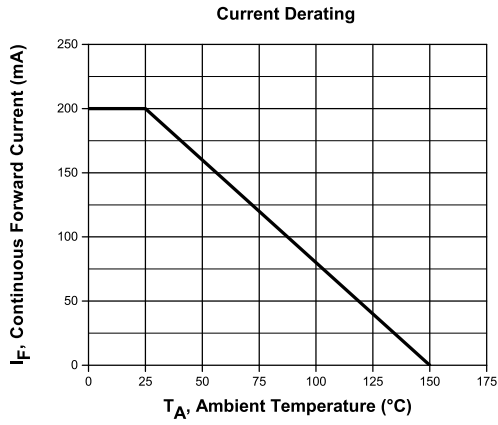

R3 (13-November 2015)

OUTSTANDING SUPPORT AND SUPERIOR SERVICES



PRODUCT SUPPORT

Central's operations team provides the highest level of support to insure product is delivered on-time.

- Supply management (Customer portals)
- Inventory bonding
- Consolidated shipping options
- Custom bar coding for shipments
- Custom product packing

DESIGNER SUPPORT/SERVICES

Central's applications engineering team is ready to discuss your design challenges. Just ask.

- Free quick ship samples (2nd day air)
- Online technical data and parametric search
- SPICE models
- Custom electrical curves
- Environmental regulation compliance
- Customer specific screening
- Up-screening capabilities
- Special wafer diffusions
- PbSn plating options
- Package details
- Application notes
- Application and design sample kits
- Custom product and package development

REQUESTING PRODUCT PLATING

1. If requesting Tin/Lead plated devices, add the suffix "TIN/LEAD" to the part number when ordering (example: 2N2222A TIN/LEAD).
2. If requesting Lead (Pb) Free plated devices, add the suffix "PBFREE" to the part number when ordering (example: 2N2222A PBFREE).

CONTACT US

Corporate Headquarters & Customer Support Team

Central Semiconductor Corp.
145 Adams Avenue
Hauppauge, NY 11788 USA
Main Tel: (631) 435-1110
Main Fax: (631) 435-1824
Support Team Fax: (631) 435-3388
www.centrasemi.com

Worldwide Field Representatives:
www.centrasemi.com/wwreps

Worldwide Distributors:
www.centrasemi.com/wwdistributors

For the latest version of Central Semiconductor's **LIMITATIONS AND DAMAGES DISCLAIMER**, which is part of Central's Standard Terms and Conditions of sale, visit: www.centrasemi.com/terms

Product End of Life Notification

PDN ID:	PDN01164
Notification Date:	2/05/21
Last Buy Date:	8/05/21
Last Shipment Date	2/05/22

Summary: The following devices manufactured in the SOT-26 case are discontinued and now classified as End of Life (EOL).

Although Central Semiconductor Corp. makes every effort to continue to produce devices that have been proclaimed EOL (End of Life) by other manufacturers, it is an accepted industry practice to discontinue certain devices when customer demand falls below a minimum level of sustainability. Accordingly, the following product(s) have been transitioned to End of Life status as part of Central's ongoing Product Management Process. Any replacement products are noted below. The effective date for placing last purchase orders will be six (6) months from the date of this notice and twelve (12) months from the notice date for final shipments, and minimum order quantities may apply. The last purchase and shipment dates may be extended if inventory is available.

*** All Plating types (PBFREE, TIN/LEAD) for each item listed are included in this notice.**

<u>Central Part Number</u>	<u>Replacement</u>
CMXDM7002A BK	N/A, Stock Only
CMXDM7002A TR	N/A, Stock Only
CMXD2004S BK	N/A, Stock Only
CMXD2004S TR	N/A, Stock Only
CMXSH2-4LS BK	N/A, Stock Only
CMXSH2-4LS TR	N/A, Stock Only
CMXSTB300 BK	N/A, Stock Only
CMXSTB300 TR	N/A, Stock Only
CMXSTB400 BK	N/A, Stock Only
CMXSTB400 TR	N/A, Stock Only
CMXT2207 BK	N/A, Stock Only
CMXT2207 TR	N/A, Stock Only
CMXT2907A BK	N/A, Stock Only
CMXT2907A TR	N/A, Stock Only

Central would be happy to assist you by providing additional information or technical data to help locate an alternate source if we have no replacement available. Please email your requests to engineering@centrasemi.com.

DISCLAIMER: This End of Life (EOL) notification is in accordance with JEDEC standard JESD48 - Product Discontinuance. Central Semiconductor Corp. will make every effort to offer life-time buy (LTB) opportunities and/or offer replacement devices to existing customers for discontinued devices, however, one or both may not be possible for all devices. Please contact your local Central Semiconductor sales representative for LTB opportunities/additional information.