

# CD4093B-Q1 CMOS QUAD 2-INPUT NAND SCHMITT TRIGGER

SCLS608A – MARCH 2005 – REVISED APRIL 2008

- Qualified for Automotive Applications
- Schmitt-Trigger Action on Each Input With No External Components
- Hysteresis Voltage Typically 0.9 V at  $V_{DD} = 5\text{ V}$  and 2.3 V at  $V_{DD} = 10\text{ V}$
- Noise Immunity Greater Than 50%
- No Limit on Input Rise and Fall Times
- Standardized, Symmetrical Output Characteristics
- 100% Tested for Quiescent Current at 20 V
- Maximum Input Current of  $1\mu\text{A}$  at 18 V Over Full Package Temperature Range, 100 nA at 18 V and  $25^\circ\text{C}$
- 5-V, 10-V, and 15-V Parametric Ratings
- ESD Protection Level Per AEC-Q100 Classification
  - 2000-V (H2) Human-Body Model
  - 200-V (M3) Machine-Model
  - 1000-V (C5) Charge-Device Model
- Applications
  - Wave and Pulse Shapers
  - High-Noise-Environment Systems
  - Monostable Multivibrators
  - Astable Multivibrators
  - NAND Logic

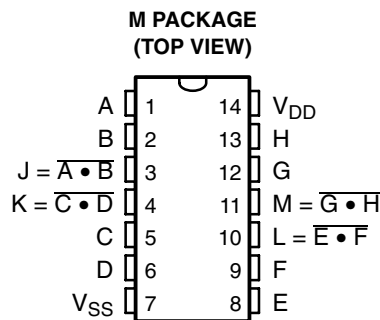

## description/ordering information

The CD4093B consists of four Schmitt-trigger circuits. Each circuit functions as a two-input NAND gate, with Schmitt-trigger action on both inputs. The gate switches at different points for positive- and negative-going signals. The difference between the positive voltage ( $V_P$ ) and the negative voltage ( $V_N$ ) is defined as hysteresis voltage ( $V_H$ ) (see Figure 2).

The CD4093B is available in 14-lead small-outline plastic package (M96) and 14-lead thin shrink small-outline packages (PWR suffixes).

## ORDERING INFORMATION<sup>†</sup>

$T_A$	PACKAGE <sup>‡</sup>		ORDERABLE PART NUMBER	TOP-SIDE MARKING
$-40^\circ\text{C}$ to $125^\circ\text{C}$	SOIC (M)	Reel of 2000	CD4093BQM96Q1	CD4093BQ

<sup>†</sup> For the most current package and ordering information, see the Package Option Addendum at the end of this document, or see the TI web site at <http://www.ti.com>.

<sup>‡</sup> Package drawings, thermal data, and symbolization are available at <http://www.ti.com/packaging>.



Please be aware that an important notice concerning availability, standard warranty, and use in critical applications of Texas Instruments semiconductor products and disclaimers thereto appears at the end of this data sheet.

PRODUCTION DATA information is current as of publication date. Products conform to specifications per the terms of Texas Instruments standard warranty. Production processing does not necessarily include testing of all parameters.

 **TEXAS  
INSTRUMENTS**

POST OFFICE BOX 655303 • DALLAS, TEXAS 75265

Copyright © 2008, Texas Instruments Incorporated

# CD4093B-Q1 CMOS QUAD 2-INPUT NAND SCHMITT TRIGGER

SCLS608A – MARCH 2005 – REVISED APRIL 2008

## functional block diagram

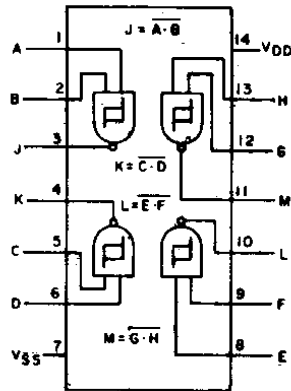

## logic diagram

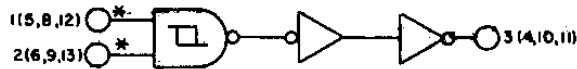

\* ALL INPUTS PROTECTED BY CMOS PROTECTION NETWORK

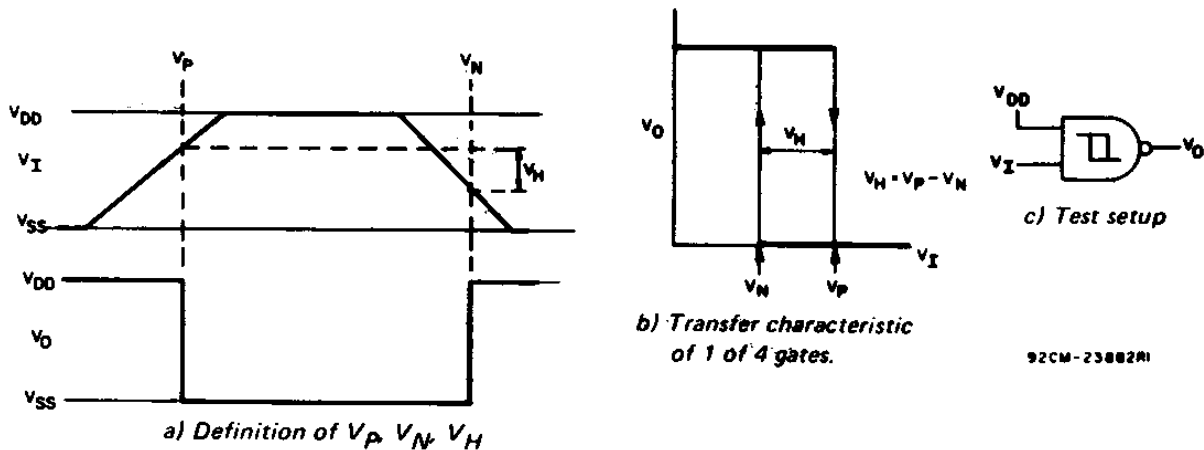
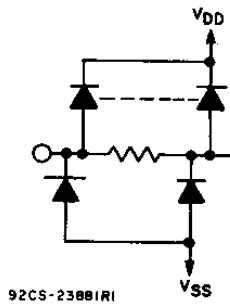

Figure 1. Hysteresis Definition, Characteristic, and Test Setup

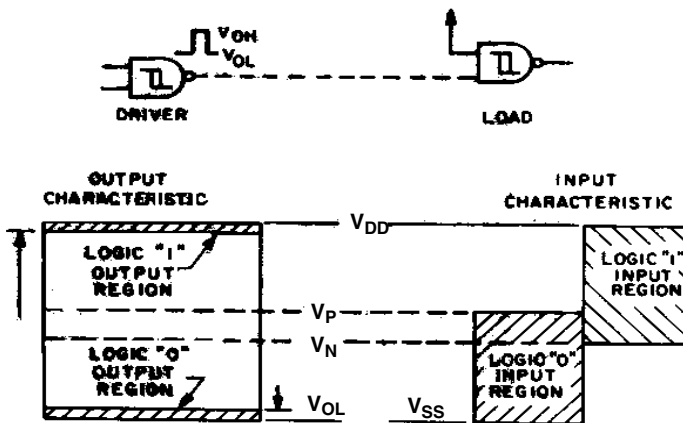

Figure 2. Input and Output Characteristics

## TYPICAL CHARACTERISTICS

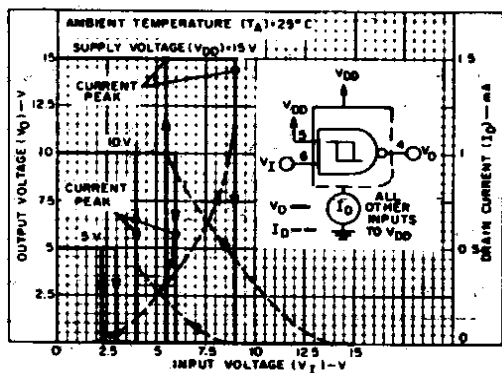

Figure 3. Typical Current and Voltage Transfer Characteristics

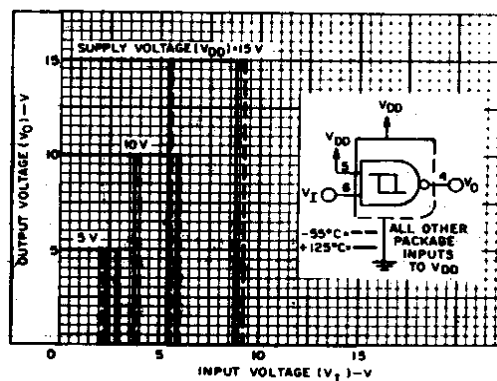

Figure 4. Typical Voltage Transfer Characteristics as a Function of Temperature

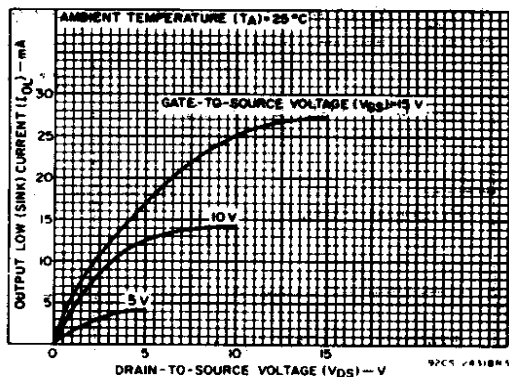

Figure 5. Typical Output Low (Sink) Current Characteristics

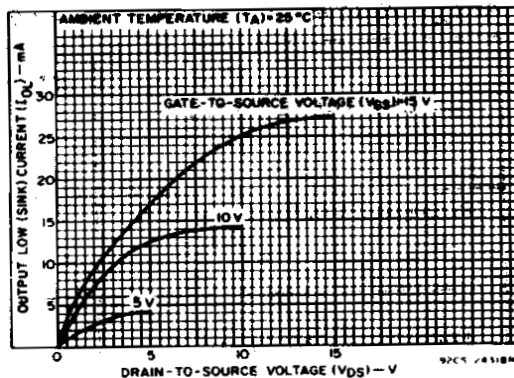

Figure 6. Minimum Output Low (Sink) Current Characteristics

# CD4093B-Q1 CMOS QUAD 2-INPUT NAND SCHMITT TRIGGER

SCLS608A – MARCH 2005 – REVISED APRIL 2008

## TYPICAL CHARACTERISTICS

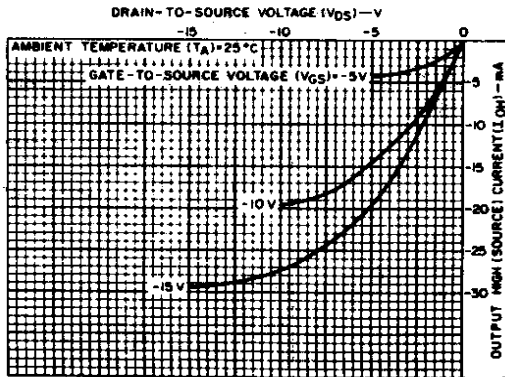

Figure 7. Typical Output High (Source) Current Characteristics

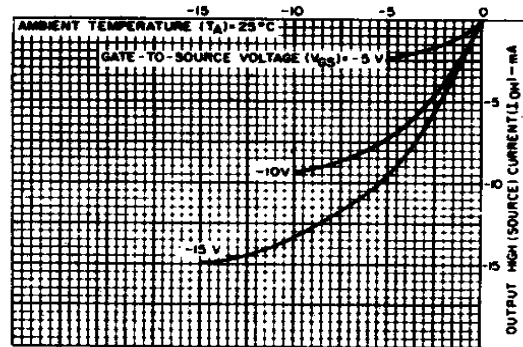

Figure 8. Minimum Output High (Source) Current Characteristics

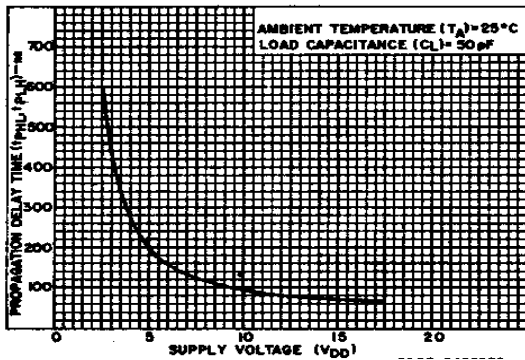

Figure 9. Typical Propagation Delay Time vs Supply Voltage

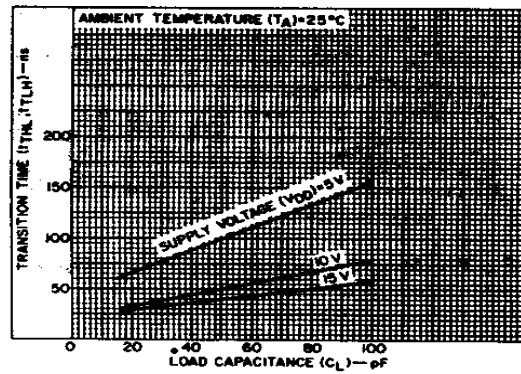

Figure 10. Typical Transition Time vs Load Capacitance

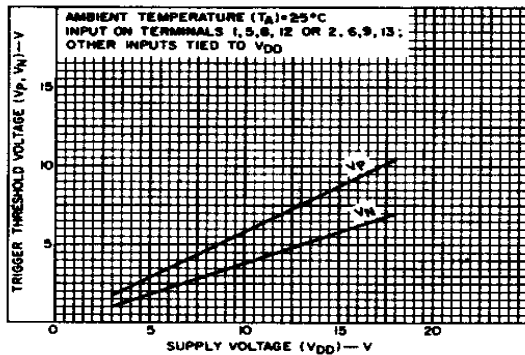

Figure 11. Typical Trigger Threshold Voltage vs  $V_{DD}$

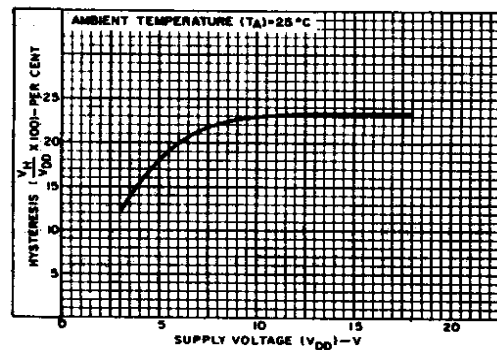

Figure 12. Typical Percent Hysteresis vs Supply Voltage

TYPICAL CHARACTERISTICS

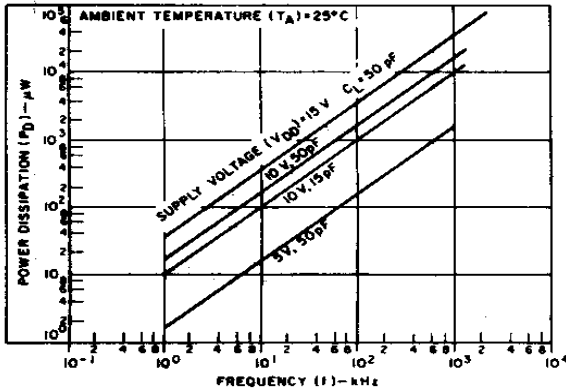

Figure 13. Typical Power Dissipation vs Frequency Characteristics

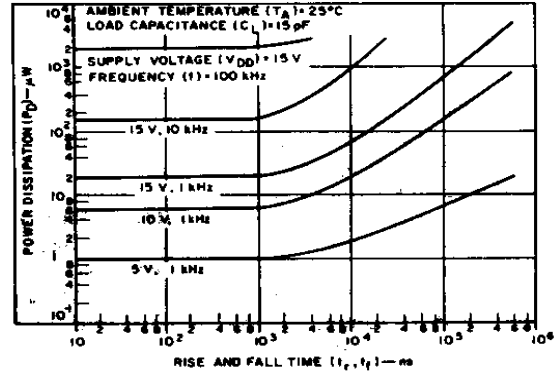
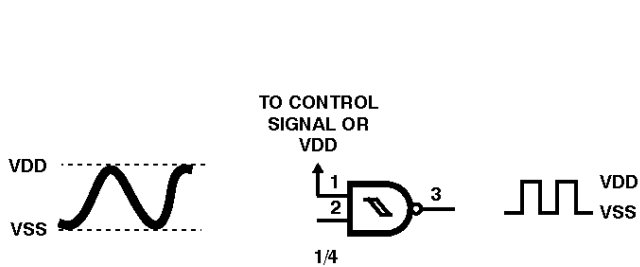

Figure 14. Typical Power Dissipation vs Rise and Fall Times

APPLICATION INFORMATION



FREQUENCY RANGE OF WAVE SHAPE IS FROM DC TO 1MHz

Figure 15. Wave Shaper

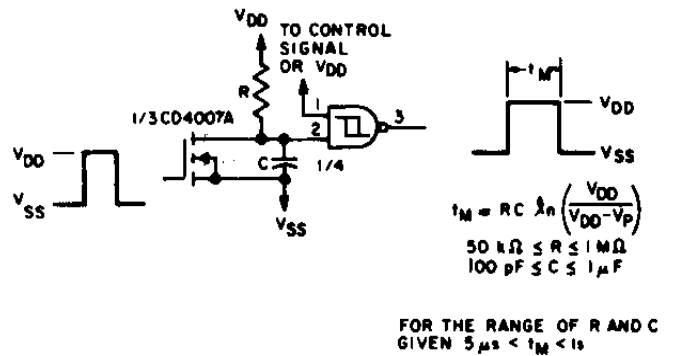

FOR THE RANGE OF R AND C GIVEN  $5\mu s < t_M < 1s$

Figure 16. Monostable Multivibrator

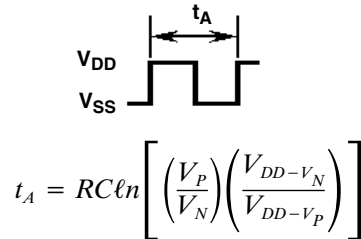
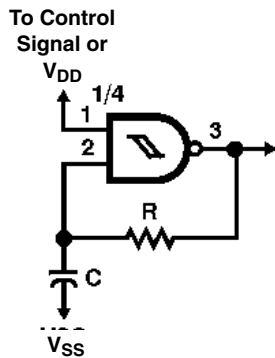

50 kΩ ≤ R ≤ 1 MΩ  
100 pF ≤ C ≤ 1 μF  
For the Range of R and C  
Given 2 ms < t<sub>A</sub> < 0.4 s

Figure 17. Astable Multivibrator

# CD4093B-Q1

## CMOS QUAD 2-INPUT NAND SCHMITT TRIGGER

SCLS608A – MARCH 2005 – REVISED APRIL 2008

### absolute maximum ratings over operating free-air temperature range (unless otherwise noted)<sup>†</sup>

DC supply voltage range, $V_{DD}$	–0.5 V to 20 V
Input voltage range, $V_I$ , all inputs	–0.5 V to $V_{DD} + 0.5$ V
DC input current, any one input	±10 mA
Package thermal impedance, $\theta_{JA}$ (see Note 1)	86°C/W
Device dissipation per output transistor for $T_A$ , all package types	100 mW
Operating temperature range, $T_A$	–40°C to 125°C
Storage temperature range, $T_{stg}$	–65°C to 150°C

<sup>†</sup> Stresses beyond those listed under “absolute maximum ratings” may cause permanent damage to the device. These are stress ratings only, and functional operation of the device at these or any other conditions beyond those indicated under “recommended operating conditions” is not implied. Exposure to absolute-maximum-rated conditions for extended periods may affect device reliability.

NOTE 1: The package thermal impedance is calculated in accordance with JESD 51-7.

### recommended operating conditions<sup>‡</sup>

	MIN	MAX	UNIT
$V_{CC}$ Supply voltage range ( $T_A$ = full package temperature range)	3	18	V

<sup>‡</sup> For maximum reliability, nominal operating conditions should be selected so that operation is always within the given range.



# CD4093B-Q1

## CMOS QUAD 2-INPUT NAND SCHMITT TRIGGER

SCLS608A – MARCH 2005 – REVISED APRIL 2008

### static electrical characteristics

CHARACTERISTIC	CONDITIONS			LIMITS AT INDICATED TEMPERATURES (°C)					UNIT
	V <sub>O</sub> (V)	V <sub>I</sub> (V)	V <sub>DD</sub> (V)	-40	85	125	25		
							MIN	TYP†	
Quiescent device current, I <sub>DD</sub> max		0,5	5	1	30	30	0.02	1	μA
		0,10	10	2	60	60	0.02	2	
		0,15	15	4	120	120	0.02	4	
		0,20	20	20	600	600	0.04	20	
Positive trigger threshold voltage, V <sub>P</sub> min		A	5	2.2	2.2	2.2	2.2	2.9	V
		A	10	4.6	4.6	4.6	4.6	5.9	
		A	15	6.8	6.8	6.8	6.8	8.8	
		B	5	2.6	2.6	2.6	2.6	3.3	
		B	10	5.6	5.6	5.6	5.6	7	
		B	15	6.3	6.3	6.3	6.3	9.4	
V <sub>P</sub> max		A	5	3.6	3.6	3.6	2.9	3.6	V
		A	10	7.1	7.1	7.1	5.9	7.1	
		A	15	10.8	10.8	10.8	8.8	10.8	
		B	5	4	4	4	3.3	4	
		B	10	8.2	8.2	8.2	7	8.2	
		B	15	12.7	12.7	12.7	9.4	12.7	
Negative trigger threshold voltage, V <sub>N</sub> min		A	5	0.9	0.9	0.9	0.9	1.9	V
		A	10	2.5	2.5	2.5	2.5	3.9	
		A	15	4	4	4	4	5.8	
		B	5	1.4	1.4	1.4	1.4	2.3	
		B	10	3.4	3.4	3.4	3.4	5.1	
		B	15	4.8	4.8	4.8	4.8	7.3	
V <sub>N</sub> max		A	5	2.8	2.8	2.8	1.9	2.8	V
		A	10	5.2	5.2	5.2	3.9	5.2	
		A	15	7.4	7.4	7.4	5.8	7.4	
		B	5	3.2	3.2	3.2	2.3	3.2	
		B	10	6.6	6.6	6.6	5.1	6.6	
		B	15	9.6	9.6	9.6	7.3	9.6	
Hysteresis voltage, V <sub>H</sub> min		A	5	0.3	0.3	0.3	0.3	0.9	V
		A	10	1.2	1.2	1.2	1.2	2.3	
		A	15	1.6	1.6	1.6	1.6	3.5	
		B	5	0.3	0.3	0.3	0.3	0.9	
		B	10	1.2	1.2	1.2	1.2	2.3	
		B	15	1.6	1.6	1.6	1.6	3.5	
V <sub>H</sub> max		A	5	1.6	1.6	1.6	0.9	1.6	V
		A	10	3.4	3.4	3.4	2.3	3.4	
		A	15	5	5	5	3.5	5	
		B	5	1.6	1.6	1.6	0.9	1.6	
		B	10	3.4	3.4	3.4	2.3	3.4	
		B	15	5	5	5	3.5	5	

NOTES: A. Inputs on terminals 1, 5, 8, 12 or 2, 6, 9, 13; other inputs to V<sub>DD</sub>.  
 B. Inputs on terminals 1 and 2, 5 and 6, 8 and 9, or 12 and 13; other inputs to V<sub>DD</sub>.



# CD4093B-Q1 CMOS QUAD 2-INPUT NAND SCHMITT TRIGGER

SCLS608A – MARCH 2005 – REVISED APRIL 2008

## static electrical characteristics (continued)

CHARACTERISTIC	CONDITIONS			LIMITS AT INDICATED TEMPERATURES (°C)					UNIT	
	V <sub>O</sub> (V)	V <sub>I</sub> (V)	V <sub>DD</sub> (V)	-40	85	125	25			
							MIN	TYP†		MAX
Output low (sink) current, I <sub>OL</sub> min	0.4	0,5	5	0.61	0.42	0.36	0.51	1	mA	
	0.5	0,10	10	1.5	1.1	0.9	1.3	2.6		
	1.5	0,15	15	4	2.8	2.4	3.4	6.8		
Output high (source) current, I <sub>OH</sub> min	4.6	0,5	5	-0.61	-0.42	-0.36	-0.51	-1	mA	
	2.5	0,5	5	-1.8	-1.3	-1.15	-1.6	-3.2		
	9.5	0,10	10	-1.5	-1.1	-0.9	-1.3	-2.6		
Output voltage low level, V <sub>OL</sub> max		0,5	5	0.05	0.05	0.05	0	0.05	V	
		0,10	10	0.05	0.05	0.05	0	0.05		
		0,15	15	0.05	0.05	0.05	0	0.05		
Output voltage high level, V <sub>OH</sub> min		0,5	5	4.95	4.95	4.95	4.95	5	V	
		0,10	10	9.95	9.95	9.95	9.95	10		
		0,15	15	14.95	14.95	14.95	14.95			
Input current, I <sub>IN</sub> max		0,18	18	±0.1	±1	±1	±10 <sup>-5</sup>	±0.1	µA	

## dynamic electrical characteristics

T<sub>A</sub> = 25°C, input t<sub>r</sub>, t<sub>f</sub> = 20 ns, C<sub>L</sub> = 50 pF, R<sub>L</sub> = 200 kΩ

CHARACTERISTIC	TEST CONDITIONS	V <sub>DD</sub> (V)	LIMITS			UNIT
			MIN	TYP	MAX	
Propagation delay time, t <sub>PHL</sub> , t <sub>PLH</sub>		5		190	380	ns
		10		90	180	
		15		65	130	
Transition time, t <sub>THL</sub> , t <sub>TLH</sub>		5		100	200	ns
		10		50	100	
		15		40	80	
Input capacitance, C <sub>IN</sub>	Any Input			5	7.5	pF





**PACKAGING INFORMATION**

Orderable Device	Status (1)	Package Type	Package Drawing	Pins	Package Qty	Eco Plan (2)	Lead finish/ Ball material (6)	MSL Peak Temp (3)	Op Temp (°C)	Device Marking (4/5)	Samples
CD4093BQM96G4Q1	ACTIVE	SOIC	D	14	2500	RoHS & Green	NIPDAU	Level-1-260C-UNLIM	-40 to 125	CD4093BQ	<a href="#">Samples</a>
CD4093BQM96Q1	ACTIVE	SOIC	D	14	2500	RoHS & Green	NIPDAU	Level-1-260C-UNLIM	-40 to 125	CD4093BQ	<a href="#">Samples</a>

(1) The marketing status values are defined as follows:

**ACTIVE:** Product device recommended for new designs.

**LIFEBUY:** TI has announced that the device will be discontinued, and a lifetime-buy period is in effect.

**NRND:** Not recommended for new designs. Device is in production to support existing customers, but TI does not recommend using this part in a new design.

**PREVIEW:** Device has been announced but is not in production. Samples may or may not be available.

**OBSOLETE:** TI has discontinued the production of the device.

(2) **RoHS:** TI defines "RoHS" to mean semiconductor products that are compliant with the current EU RoHS requirements for all 10 RoHS substances, including the requirement that RoHS substance do not exceed 0.1% by weight in homogeneous materials. Where designed to be soldered at high temperatures, "RoHS" products are suitable for use in specified lead-free processes. TI may reference these types of products as "Pb-Free".

**RoHS Exempt:** TI defines "RoHS Exempt" to mean products that contain lead but are compliant with EU RoHS pursuant to a specific EU RoHS exemption.

**Green:** TI defines "Green" to mean the content of Chlorine (Cl) and Bromine (Br) based flame retardants meet JS709B low halogen requirements of <=1000ppm threshold. Antimony trioxide based flame retardants must also meet the <=1000ppm threshold requirement.

(3) MSL, Peak Temp. - The Moisture Sensitivity Level rating according to the JEDEC industry standard classifications, and peak solder temperature.

(4) There may be additional marking, which relates to the logo, the lot trace code information, or the environmental category on the device.

(5) Multiple Device Markings will be inside parentheses. Only one Device Marking contained in parentheses and separated by a "~" will appear on a device. If a line is indented then it is a continuation of the previous line and the two combined represent the entire Device Marking for that device.

(6) Lead finish/Ball material - Orderable Devices may have multiple material finish options. Finish options are separated by a vertical ruled line. Lead finish/Ball material values may wrap to two lines if the finish value exceeds the maximum column width.

**Important Information and Disclaimer:**The information provided on this page represents TI's knowledge and belief as of the date that it is provided. TI bases its knowledge and belief on information provided by third parties, and makes no representation or warranty as to the accuracy of such information. Efforts are underway to better integrate information from third parties. TI has taken and continues to take reasonable steps to provide representative and accurate information but may not have conducted destructive testing or chemical analysis on incoming materials and chemicals. TI and TI suppliers consider certain information to be proprietary, and thus CAS numbers and other limited information may not be available for release.

In no event shall TI's liability arising out of such information exceed the total purchase price of the TI part(s) at issue in this document sold by TI to Customer on an annual basis.

**OTHER QUALIFIED VERSIONS OF CD4093B-Q1 :**

- Catalog: [CD4093B](#)
- Military: [CD4093B-MIL](#)

## NOTE: Qualified Version Definitions:



- Catalog - TI's standard catalog product
- Military - QML certified for Military and Defense Applications

D (R-PDSO-G14)

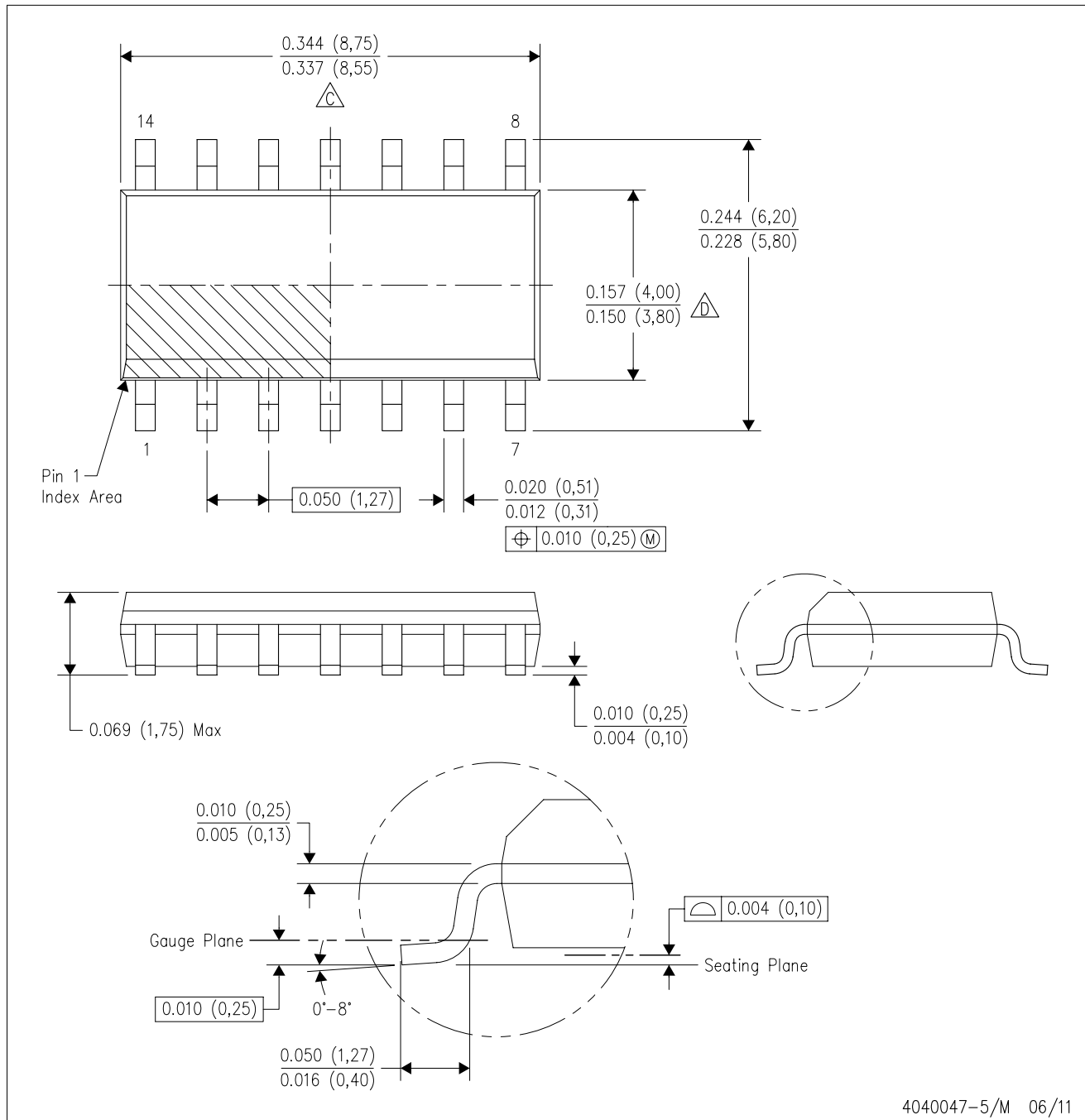
PLASTIC SMALL OUTLINE



4040047-5/M 06/11

- NOTES:
- A. All linear dimensions are in inches (millimeters).
  - B. This drawing is subject to change without notice.
  -  Body length does not include mold flash, protrusions, or gate burrs. Mold flash, protrusions, or gate burrs shall not exceed 0.006 (0,15) each side.
  -  Body width does not include interlead flash. Interlead flash shall not exceed 0.017 (0,43) each side.
  - E. Reference JEDEC MS-012 variation AB.

## IMPORTANT NOTICE AND DISCLAIMER

TI PROVIDES TECHNICAL AND RELIABILITY DATA (INCLUDING DATA SHEETS), DESIGN RESOURCES (INCLUDING REFERENCE DESIGNS), APPLICATION OR OTHER DESIGN ADVICE, WEB TOOLS, SAFETY INFORMATION, AND OTHER RESOURCES "AS IS" AND WITH ALL FAULTS, AND DISCLAIMS ALL WARRANTIES, EXPRESS AND IMPLIED, INCLUDING WITHOUT LIMITATION ANY IMPLIED WARRANTIES OF MERCHANTABILITY, FITNESS FOR A PARTICULAR PURPOSE OR NON-INFRINGEMENT OF THIRD PARTY INTELLECTUAL PROPERTY RIGHTS.

These resources are intended for skilled developers designing with TI products. You are solely responsible for (1) selecting the appropriate TI products for your application, (2) designing, validating and testing your application, and (3) ensuring your application meets applicable standards, and any other safety, security, regulatory or other requirements.

These resources are subject to change without notice. TI grants you permission to use these resources only for development of an application that uses the TI products described in the resource. Other reproduction and display of these resources is prohibited. No license is granted to any other TI intellectual property right or to any third party intellectual property right. TI disclaims responsibility for, and you will fully indemnify TI and its representatives against, any claims, damages, costs, losses, and liabilities arising out of your use of these resources.

TI's products are provided subject to [TI's Terms of Sale](#) or other applicable terms available either on [ti.com](https://www.ti.com) or provided in conjunction with such TI products. TI's provision of these resources does not expand or otherwise alter TI's applicable warranties or warranty disclaimers for TI products.

TI objects to and rejects any additional or different terms you may have proposed.

Mailing Address: Texas Instruments, Post Office Box 655303, Dallas, Texas 75265  
Copyright © 2023, Texas Instruments Incorporated