



Dynamic Series | Dynamic 3000 Series

TE Internal #: 175216-3

Connector Contact, Receptacle, Component-to-Wire, 28 – 24 AWG
 Wire Size, .08 – .24 mm² Wire Size, Gold, Bag & Box, Wire & Cable,
 Dynamic 3000 Series

[View on TE.com >](#)

Connectors > PCB Connectors > Wire-to-Board Connectors > Wire-to-Board Connector Contacts >

Contact: Component To Wire; 15A, 28-14 wire size

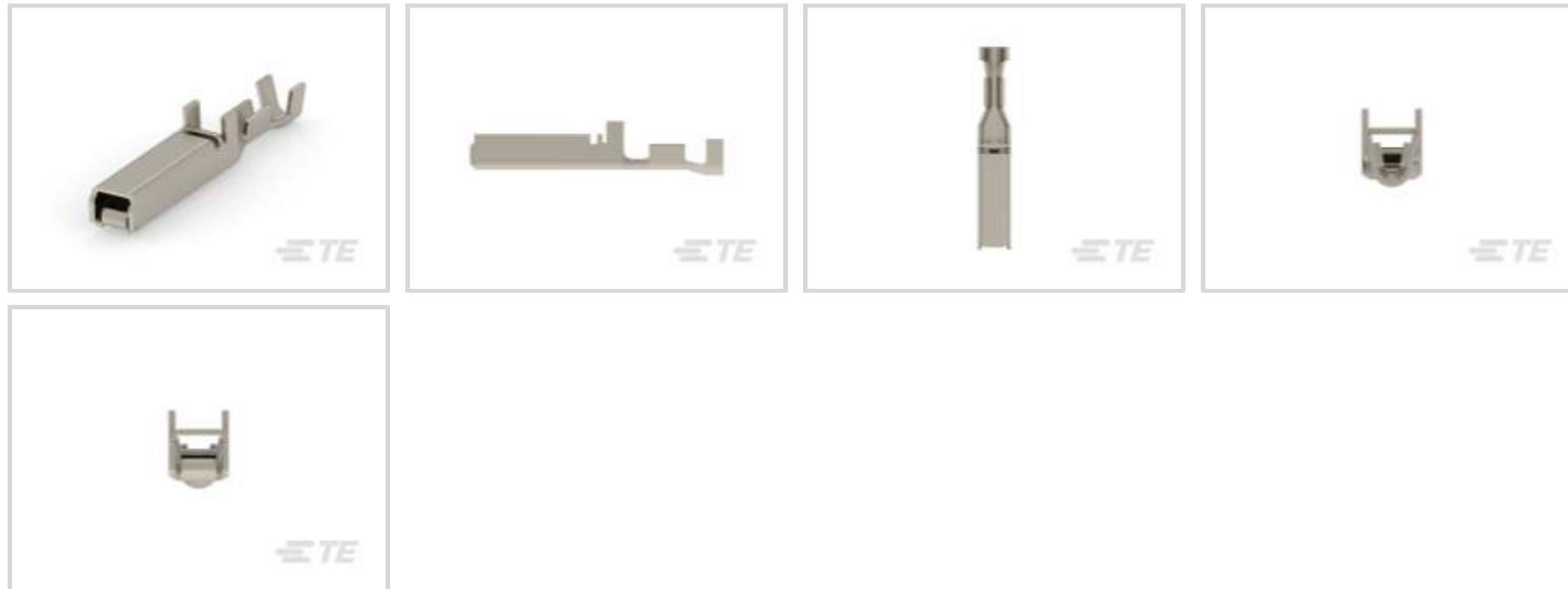

Contact Type: **Receptacle**

Connector System: **Component-to-Wire**

Wire Size: **.08 – .24 mm²**

Contact Mating Area Plating Material: **Gold**

[All Contact: Component To Wire; 15A, 28-14 wire size \(91\)](#)

Features

Product Type Features

Connector System	Component-to-Wire
Connector & Contact Terminates To	Wire & Cable

Contact Features

Mating Tab Width	2 mm[.08 in]
Mating Tab Thickness	.64 mm[.025 in]
Contact Type	Receptacle
Contact Mating Area Plating Material	Gold
Contact Current Rating (Max)	15 A

Dimensions

Wire Size	.08 – .24 mm ²
-----------	---------------------------

Usage Conditions

Operating Temperature Range	-55 – 105 °C[-67 – 221 °F]
-----------------------------	----------------------------

Operation/Application

Circuit Application

Power & Signal

Packaging Features

Packaging Method

Bag & Box

Product Compliance

For compliance documentation, visit the product page on [TE.com](https://www.te.com)>

EU RoHS Directive 2011/65/EU

Compliant

EU ELV Directive 2000/53/EC

Compliant

China RoHS 2 Directive MIIT Order No 32, 2016

No Restricted Materials Above Threshold

EU REACH Regulation (EC) No. 1907/2006

Current ECHA Candidate List: JUNE 2023 (235)
Candidate List Declared Against: JUNE 2023 (235)
Does not contain REACH SVHC

Halogen Content

Low Halogen - Br, Cl, F, I < 900 ppm per homogenous material. Also BFR/CFR/PVC Free

Solder Process Capability

Not applicable for solder process capability

Product Compliance Disclaimer

This information is provided based on reasonable inquiry of our suppliers and represents our current actual knowledge based on the information they provided. This information is subject to change. The part numbers that TE has identified as EU RoHS compliant have a maximum concentration of 0.1% by weight in homogenous materials for lead, hexavalent chromium, mercury, PBB, PBDE, DBP, BBP, DEHP, DIBP, and 0.01% for cadmium, or qualify for an exemption to these limits as defined in the Annexes of Directive 2011/65/EU (RoHS2). Finished electrical and electronic equipment products will be CE marked as required by Directive 2011/65/EU. Components may not be CE marked. Additionally, the part numbers that TE has identified as EU ELV compliant have a maximum concentration of 0.1% by weight in homogenous materials for lead, hexavalent chromium, and mercury, and 0.01% for cadmium, or qualify for an exemption to these limits as defined in the Annexes of Directive 2000/53/EC (ELV). Regarding the REACH Regulation, the information TE provides on SVHC in articles for this part number is based on the latest European Chemicals Agency (ECHA) 'Guidance on requirements for substances in articles' posted at this URL: <https://echa.europa.eu/guidance-documents/guidance-on-reach>

Compatible Parts



TE Part # CAT-D9934-A75B
Receptacle and Tab Housing: 5.08 mm Pitch, 250-600V



TE Part # CAT-D9934-A75A
Receptacle and Tab Housing: 3.81 mm pitch, 250V



TE Part # CAT-D9934-A75C
Receptacle and Tab Housing: 5.08 mm pitch, 600V



TE Part # 234168-1
EXTRACTION TOOL(DYNAMIC D-3)

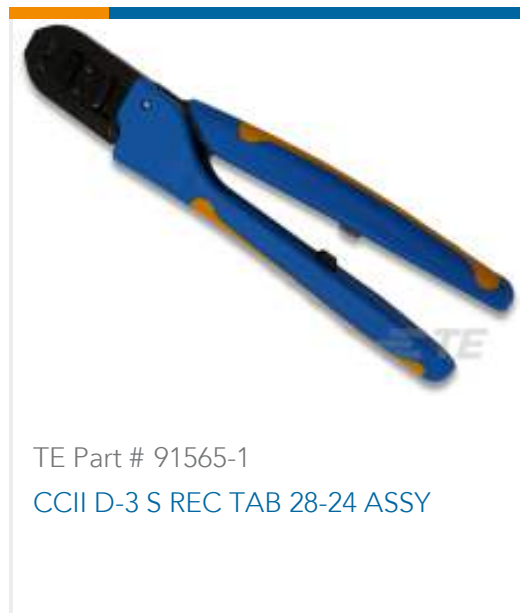

Also in the Series | Dynamic 3000 Series

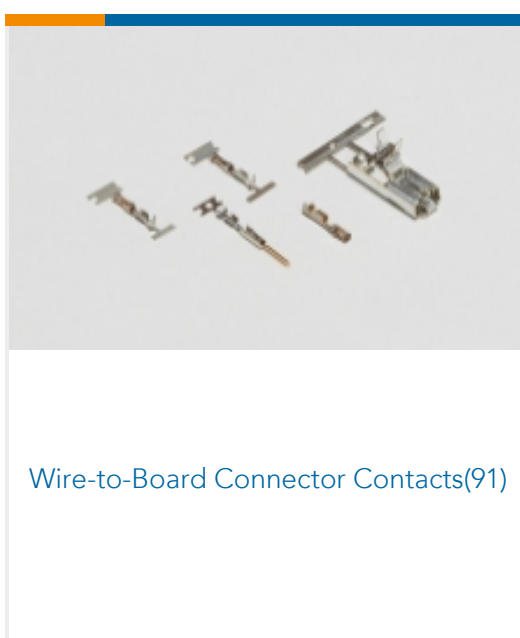
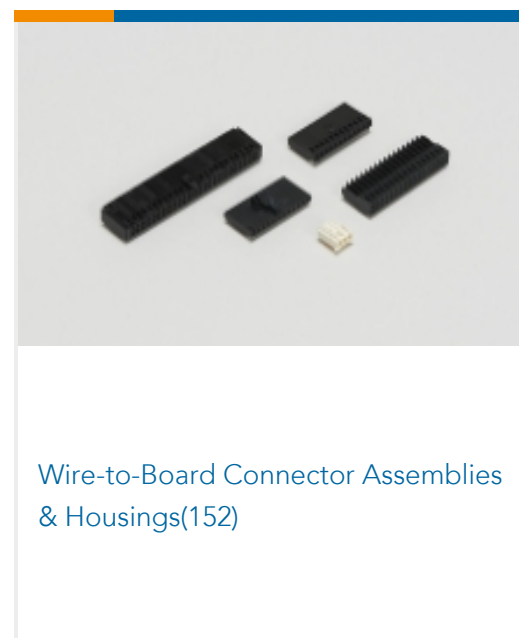
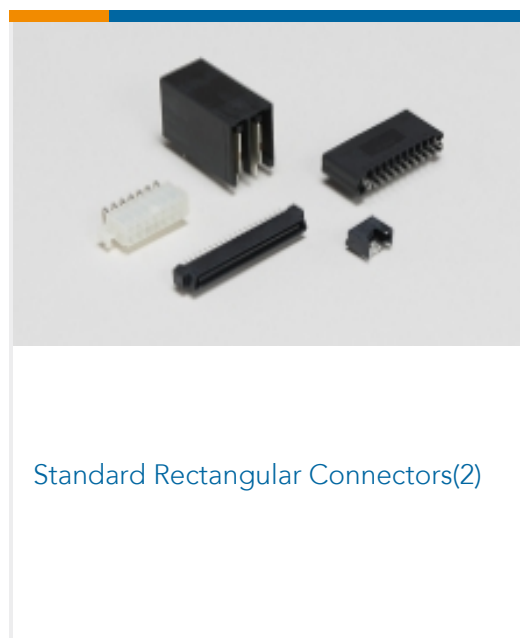
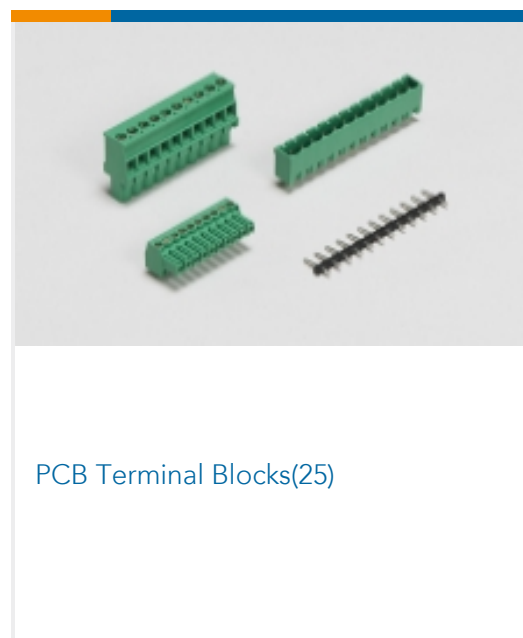
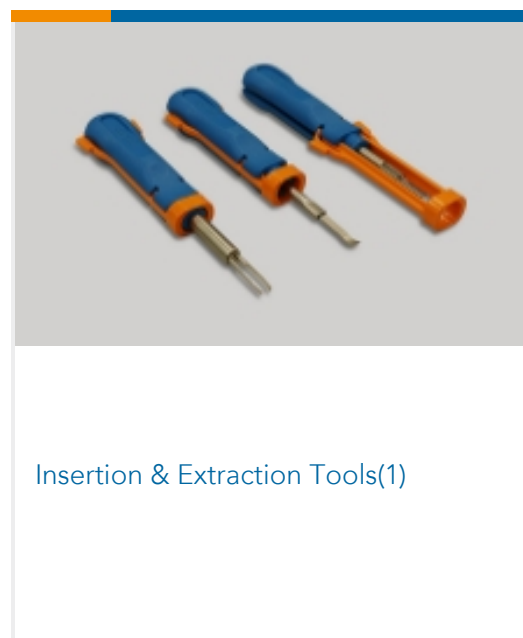
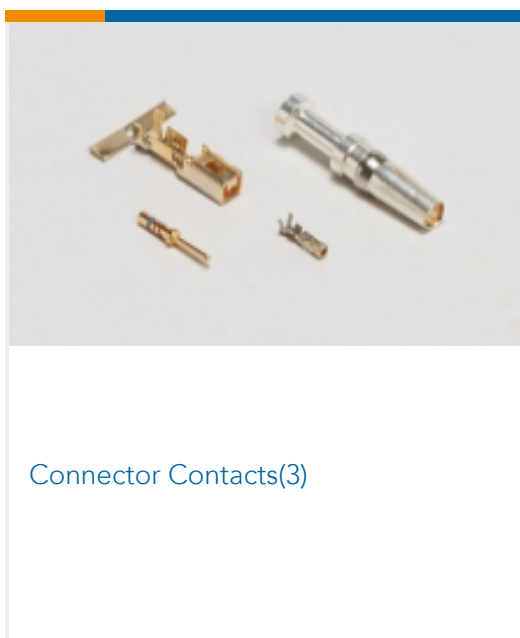

Customers Also Bought



TE Part #917805-2
DYNAMIC D-5 TAB CONT. M L/P



TE Part #175288-3
Contact: Component To Wire; 15A, 28-14 wire size

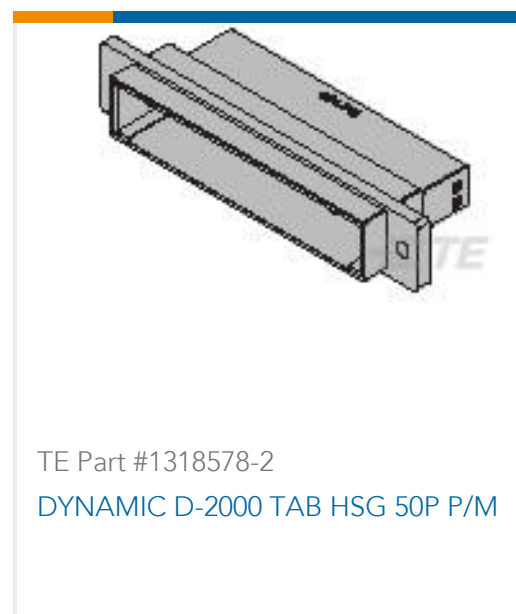

TE Part #1318578-2
DYNAMIC D-2000 TAB HSG 50P P/M



TE Part #1623730-1
BCHE 4 W 100R 5%



TE Part #A49199-000
B-155-3809



TE Part #1376059-1
FIXED HEAD SCREW FOR DYNAMIC

Documents

Product Drawings

[DYNAMIC REC CONT. S L/P](#)

English

CAD Files

[3D PDF](#)

English

[Customer View Model](#)

[ENG_CVM_175216-3_A2.3d_igs.zip](#)

English

[Customer View Model](#)

[ENG_CVM_175216-3_A2.3d_stp.zip](#)

English

[Customer View Model](#)

[ENG_CVM_175216-3_A2.2d_dxf.zip](#)

English

By downloading the CAD file I accept and agree to the [Terms and Conditions](#) of use.

Datasheets & Catalog Pages

[1-1773732-4_DYNAMIC_SERIES_CATALOG_ENGLISH](#)

Japanese

[1-1773732-4_DYNAMIC_SERIES_CATALOG_ENGLISH](#)

English

Product Specifications

[Application Specification](#)

English



Product Environmental Compliance

Product Compliance

English

Product Compliance

English

Instruction Sheets

Instruction Sheet (non U.S.)

Japanese

Instruction Sheet (non U.S.)

English

Agency Approvals

TUV Certificate

English