

XS9D111A2L2

Inductive proximity sensors XS, inductive sensor XS9 80x80x26, PBT, Sn40mm, 24 VDC, cable 2 m



Main

| | |
|------------------------------------|--|
| Range of Product | Telemecanique Inductive proximity sensors XS |
| Series name | Application |
| Sensor Type | Inductive proximity sensor |
| Device Application | - |
| Sensor name | XS9 |
| Sensor design | Flat form 80 x 80 x 26 |
| Size | 26 mm |
| Body type | Fixed |
| Detector flush mounting acceptance | Flush mountable |
| Material | Plastic |
| Enclosure Material | PBT |
| Type of output signal | Analogue |
| Wiring Technique | 2-wire |
| [Sn] nominal sensing distance | 1.57 in (40 mm) |
| Output circuit type | DC |
| Analogue output range | 4...20 mA |
| Electrical connection | Cable |
| Cable length | 6.56 ft (2 m) |
| [Us] rated supply voltage | 24 V DC |
| IP degree of protection | IP68 double insulation conforming to IEC 60529 |

Complementary

| | |
|------------------------------|----------------------------|
| Detection face | Frontal |
| Front material | PBT |
| Operating zone | 0.20...1.57 in (5...40 mm) |
| Repeat accuracy | <= 3% of Sr |
| Linearity error | +/- 2 mA |
| Cable composition | 3 x 0.34 mm ² |
| Wire insulation material | PvR |
| Status LED | without |
| Supply voltage limits | 15...36 V DC |
| Switching frequency | <= 100 Hz |
| Current consumption | 0...4 mA no-load |
| Maximum output current drift | 10 % |
| Marking | CE |
| Depth | 1.02 in (26 mm) |
| Height | 3.15 in (80 mm) |
| Width | 3.15 in (80 mm) |

The information provided in this documentation contains general descriptions and/or technical characteristics of the performance of the products contained herein. This documentation is not intended as a substitute for and is not to be used for determining suitability or reliability of these products for specific user applications. It is the duty of any such user or integrator to perform the appropriate and complete risk analysis, evaluation and testing of the products with respect to the relevant specific application or use thereof. Neither Schneider Electric Industries SAS nor any of its affiliates or subsidiaries shall be responsible or liable for misuse of the information contained herein.

Environment

| | |
|---------------------------------------|---|
| Product Certifications | UL CSA Ecolab |
| Ambient Air Temperature for Operation | -13...158 °F (-25...70 °C) |
| Ambient Air Temperature for Storage | -40...185 °F (-40...85 °C) |
| Vibration resistance | 25 gn +/- 2 mm 10...55 Hz)IEC 60068-2-6 |
| Shock resistance | 50 gn 11 ms IEC 60068-2-27 |



Ordering and shipping details

| | |
|-----------------------|--------------------------|
| Category | 22486-SENSORS, PROXIMITY |
| Discount Schedule | DS2 |
| GTIN | 3389110356090 |
| Nbr. of units in pkg. | 1 |
| Package weight(Lbs) | 15.27 oz (433.0 g) |
| Returnability | No |
| Country of origin | FR |

Packing Units

| | |
|------------------------------|------------------------|
| Unit Type of Package 1 | PCE |
| Package 1 Height | 5.20 in (13.2 cm) |
| Package 1 width | 2.60 in (6.6 cm) |
| Package 1 Length | 3.74 in (9.5 cm) |
| Unit Type of Package 2 | S01 |
| Number of Units in Package 2 | 7 |
| Package 2 Weight | 7.07 lb(US) (3.208 kg) |
| Package 2 Height | 5.91 in (15 cm) |
| Package 2 width | 5.91 in (15 cm) |
| Package 2 Length | 15.75 in (40 cm) |

Offer Sustainability

| | |
|----------------------------|---|
| California proposition 65 | WARNING: This product can expose you to chemicals including: Diisononyl phthalate (DINP), which is known to the State of California to cause cancer, and Di-isodecyl phthalate (DIDP), which is known to the State of California to cause birth defects or other reproductive harm. For more information go to www.P65Warnings.ca.gov |
| REACH Regulation |  REACH Declaration |
| EU RoHS Directive | Pro-active compliance (Product out of EU RoHS legal scope)  EU RoHS Declaration |
| Mercury free | Yes |
| RoHS exemption information |  Yes |

Contractual warranty

| | |
|----------|-----------|
| Warranty | 18 months |
|----------|-----------|

Dimensions

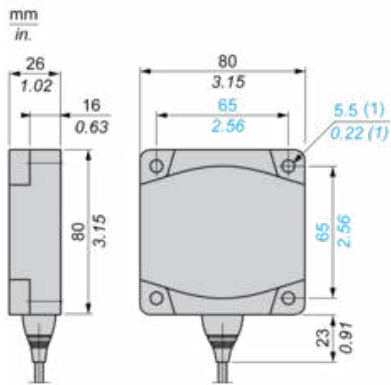

(1) For CHC type screws

Setting-up

Minimum Mounting Distances (mm)

Side by Side



$e (1) \geq 120$

Face to Face

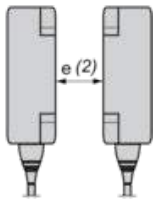

$e (2) \geq 300$

Facing a Metal Object



$e (3) \geq 120$

Wiring Schemes

2-Wire Connection

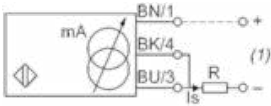

BU : Blue

BN : Brown

BK : Black

(1) Output current

Ensure a minimum of 10 V between the + (terminal 1) and - (terminal 3) of the sensor

| | Output current | Load impedance value |
|------|----------------|----------------------|
| 12 V | 4...20 mA | $R \leq 8.2 \Omega$ |
| 24 V | 4...20 mA | $R \leq 470 \Omega$ |

Output Curves

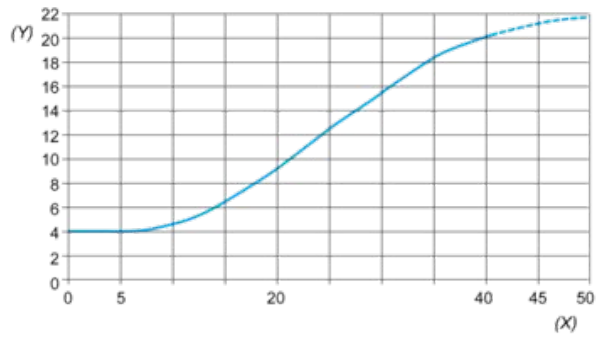

(Y) Is (mA)

(X) Sensors - object distance (mm)