



Jan. 2022 Ver.2.0a
TDK Corporation

Multilayer Diplexer

For 704-1610MHz / 2400-5950MHz

DPX Series 1.6x0.8mm [EIA 0603] TYPE

P/N: **DPX165950DT-8044A1**

DPX165950DT-8044A1

■ SHAPES AND DIMENSIONS

[Top View]

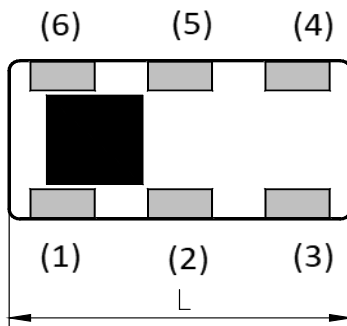

[Bottom View]

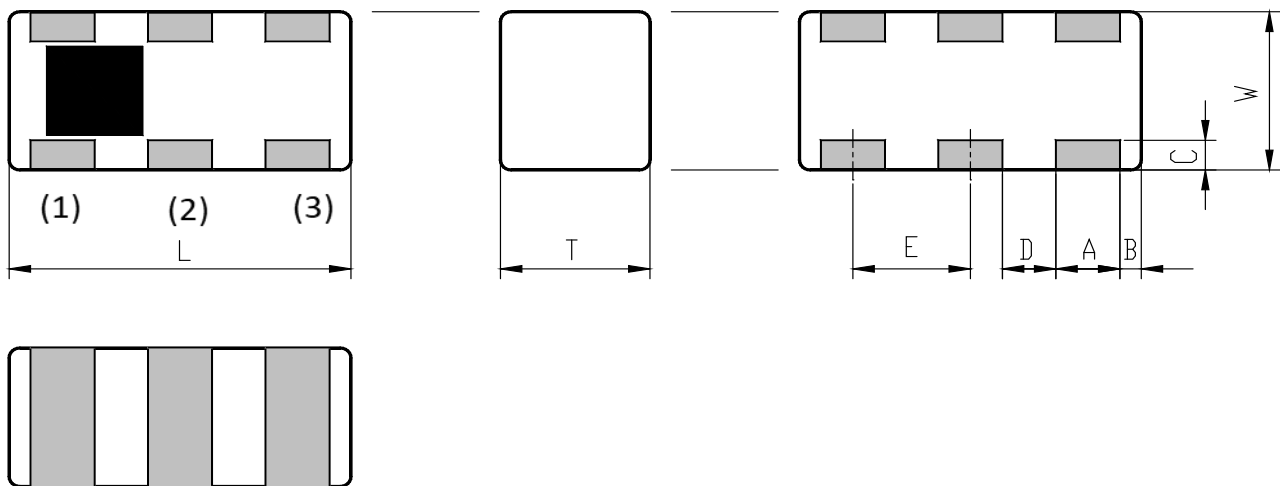

Dimensions (mm)

L	W	T	A	B	C	D	E
1.60	0.80	0.60	0.30	0.10	0.15	0.25	0.55
+/-0.15	+/-0.15	+/-0.10	+/-0.15	+0.15 /-0.10	+/-0.15	+/-0.15	+/-0.10

Terminal functions

(1)	GND
(2)	Common Port
(3)	GND

(4)	High-Band Port
(5)	GND
(6)	Low-Band Port

■ TERMINATION FINISH

Material
Sn plate

DPX165950DT-8044A1**ELECTRICAL CHARACTERISTICS**

(Measurement)

Low-Band

Parameter	Frequency (MHz)	TDK Spec		
		Min.	Typ.	Max.
Insertion Loss (dB)	704 to 960	-	0.29	0.40
	1572 to 1578	-	0.35	0.40
	1570 to 1610	-	0.37	0.45
Insertion Loss (dB) (-40 to +85 °C)	704 to 960	-	-	0.60
	1572 to 1578	-	-	0.60
	1570 to 1610	-	-	0.65
VSWR (Low-Band Port)	704 to 960	-	1.11	1.92
	1572 to 1578	-	1.19	1.92
	1570 to 1610	-	1.20	1.92
Attenuation (dB)	2400 to 2500	15	19	-
	2500 to 2690	10	14	-
	4900 to 5150	17	29	-
	5150 to 5850	17	21	-
	5850 to 5950	16	20	-
Characteristic Impedance (ohm)		50 (Nominal)		

Ta = +25+/-5°C

High-Band

Parameter	Frequency (MHz)	TDK Spec		
		Min.	Typ.	Max.
Insertion Loss (dB)	2400 to 2500	-	0.39	0.55
	2500 to 2690	-	0.48	0.55
	4900 to 5150	-	0.24	0.50
	5150 to 5850	-	0.23	0.50
	5850 to 5950	-	0.25	0.50
Insertion Loss (dB) (-40 to +85 °C)	2400 to 2500	-	-	0.75
	2500 to 2690	-	-	0.75
	4900 to 5150	-	-	0.70
	5150 to 5850	-	-	0.70
	5850 to 5950	-	-	0.70
VSWR (High-Band Port)	2400 to 2500	-	1.12	1.92
	2500 to 2690	-	1.26	1.92
	4900 to 5150	-	1.47	1.92
	5150 to 5850	-	1.37	1.92
	5850 to 5950	-	1.19	1.92
Attenuation (dB)	704 to 960	12	14	-
	1572 to 1578	20	23	-
	1570 to 1610	20	23	-
Characteristic Impedance (ohm)		50 (Nominal)		

Ta = +25+/-5°C

DPX165950DT-8044A1

■ MAXIMUM RATINGS

Parameter	TDK Spec	Conditions
Operating temperature (°C)	-40 to +85 °C	
Storage temperature (°C)	-40 to +85 °C	
Power Handling (W) *1	4	Duty 50%
Human Body Model : HBM @Each Port (V)	+/-1000	100pF / 1500ohm
Machine Model : MM @Each Port (V)	+/-150	200pF / 0ohm
Charged Device Model : CDM @Each Port (V)	+/-500	Humidity : 60%RH max

*1 : Refer to 3GPP TS 38.101-1 V15.2.0

DPX165950DT-8044A1

FREQUENCY CHARACTERISTICS

Low-Band Port Insertion Loss

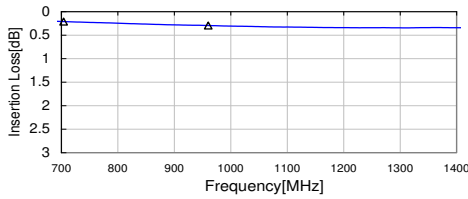

High-Band Port Insertion Loss

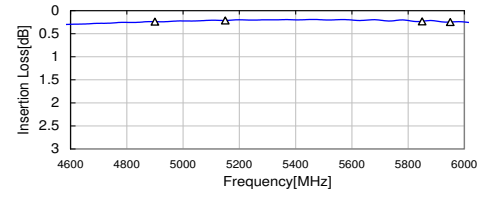
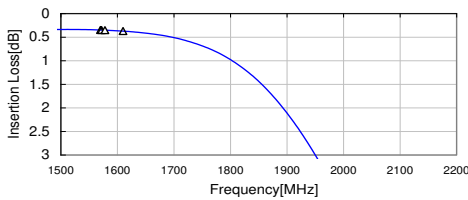
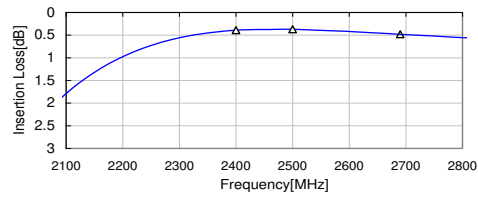

Low-Band Port Attenuation

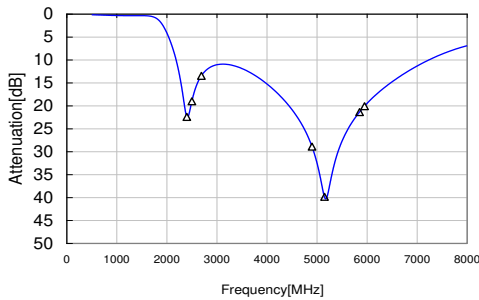

High-Band Port Attenuation

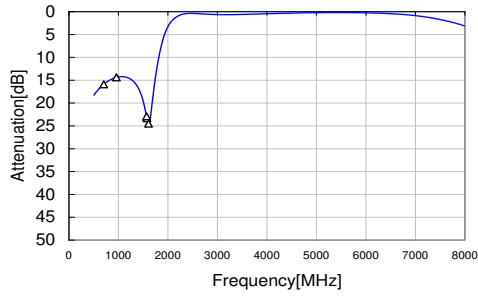

Low-Band Port VSWR

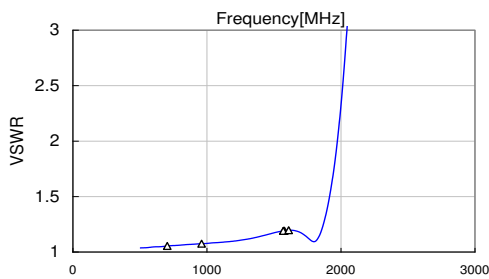

High-Band Port VSWR

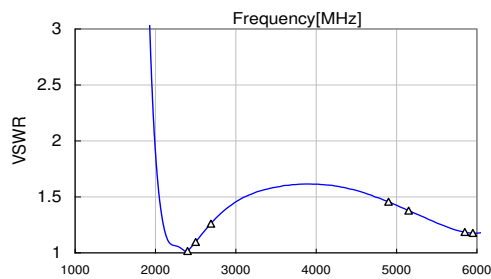

Common Port VSWR

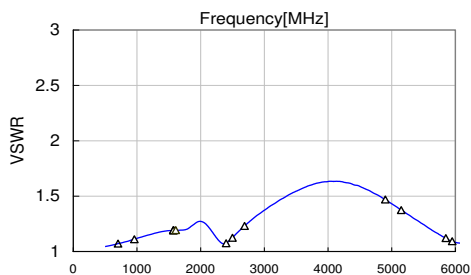

Isolation (Low - High)

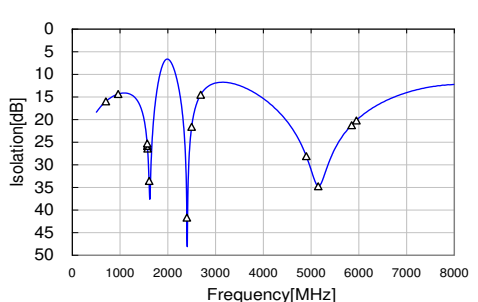

DPX165950DT-8044A1

RECOMMENDED LAND PATTERN

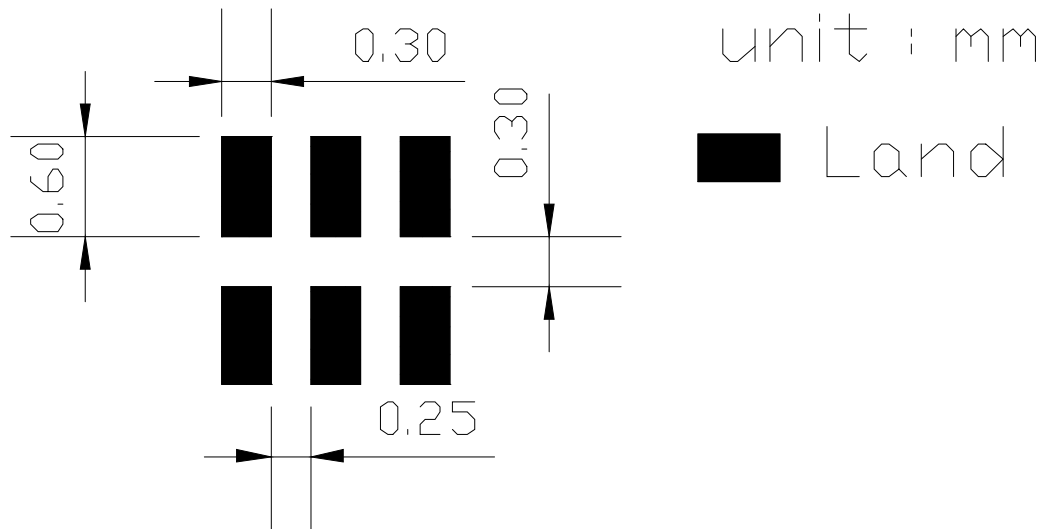

ENVIRONMENT INFORMATION

RoHS Statement
RoHS Compliance

DPX165950DT-8044A1

RECOMMENDED REFLOW PROFILE

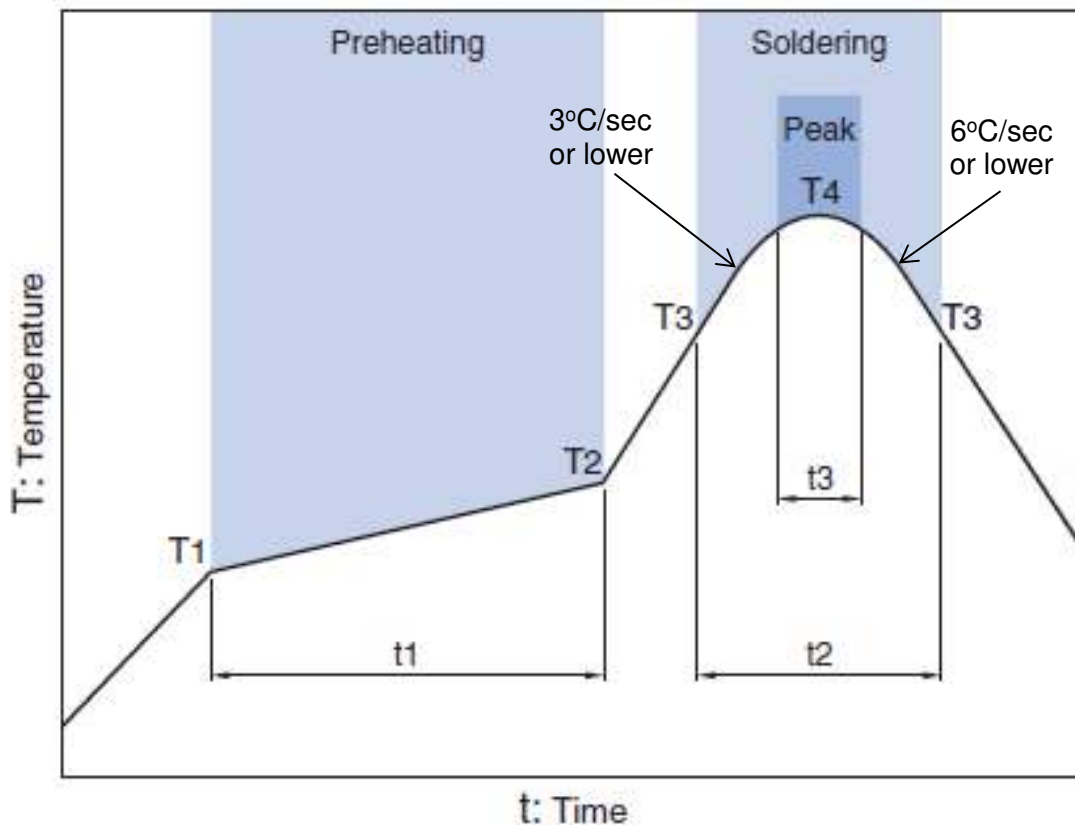

Preheating			Soldering			
			Critical zone (T3 to T4)		Peak	
Temp.		Time	Temp.	Time	Temp.	Time
T1	T2	t1	T3	t2	T4	t3 *
150°C	200°C	60 to 120sec	217°C	60 to 120sec	240 to 260°C	30 sec Max

* t3 : Time within 5°C of actual peak temperature

The maximum number of reflow is 3.

Note: Lead free solder is recommended.
Recommended solder is Sn-3.0Ag-0.5Cu. (M705 by Senju Metal Industry)

DPX165950DT-8044A1**PACKAGING STYLE**

Reel Dimensions

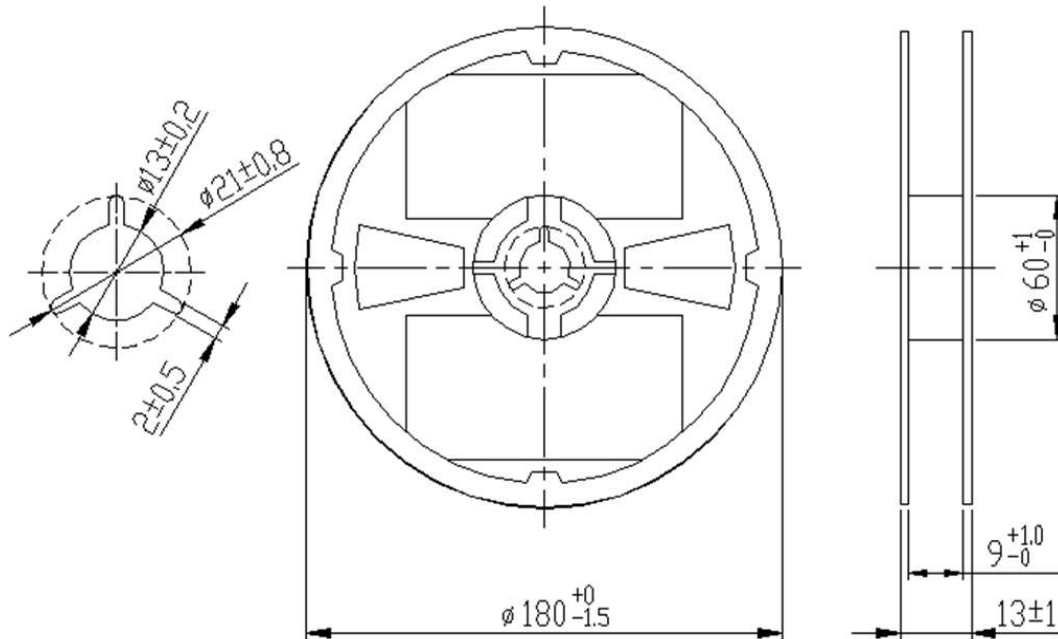

Dimensions in mm

Carrier Tape

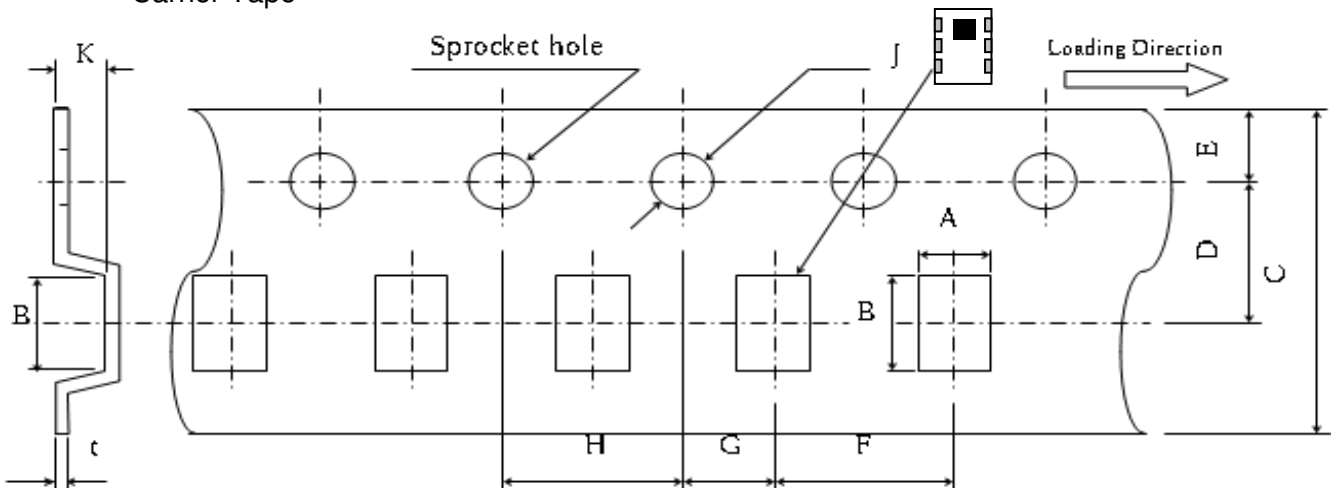

Dimensions (mm)

A	B	C	D	E	F	G	H	J	K	t
0.97	1.8	8.0	3.5	1.75	4.0	2.0	4.0	1.5	0.8	0.25
+/-0.05	+/-0.05	+/-0.2	+/-0.05	+/-0.1	+/-0.1	+/-0.05	+/-0.1	+0.1/-0	MAX	+/-0.05

STANDARD PACKAGE QUANTITY
(pieces/reel)

4,000

REMINDERS FOR USING THESE PRODUCTS

Before using these products, be sure to request the delivery specifications.

SAFETY REMINDERS

Please pay sufficient attention to the warnings for safe designing when using these products.

REMINDERS

The products listed on this catalog are intended for use in general electronic equipment (AV equipment, telecommunications equipment, home appliances, amusement equipment, computer equipment, personal equipment, office equipment, measurement equipment, industrial robots) under a normal operation and use condition.

The products are not designed or warranted to meet the requirements of the applications listed below, whose performance and/or quality require a more stringent level of safety or reliability, or whose failure, malfunction or trouble could cause serious damage to society, person or property.

Please understand that we are not responsible for any damage or liability caused by use of the products in any of the applications below or for any other use exceeding the range or conditions set forth in this catalog.

- | | |
|---|--|
| (1) Aerospace/Aviation equipment | (8) Public information-processing equipment |
| (2) Transportation equipment (cars, electric trains, ships, etc.) | (9) Military equipment |
| (3) Medical equipment | (10) Electric heating apparatus, burning equipment |
| (4) Power-generation control equipment | (11) Disaster prevention/crime prevention equipment |
| (5) Atomic energy-related equipment | (12) Safety equipment |
| (6) Seabed equipment | (13) Other applications that are not considered general-purpose applications |
| (7) Transportation control equipment | |

When using this product in general-purpose applications, you are kindly requested to take into consideration securing protection circuit/equipment or providing backup circuits, etc., to ensure higher safety.