

# GM1BD78140A

## High Brightness Chip LED (White)



### ■ Features

1. High brightness (24 lm @ 150 mA)
2. White Color (achieved via InGaN Blue LED chips in combination with Yellow Phosphor)
3. Four-chip light source
4. Compact Package
5. Size: 2.64 × 1.64 × 0.7 mm

### ■ Agency Approvals/Compliance

1. RoHS compliant

### ■ Applications

1. General indoor Illumination
2. Lighting
  - a. Commercial
  - b. Industrial
  - c. Architectural
  - d. Portable and Personal
3. Backlighting
4. Reading Lamps

Notice The content of this data sheet is subject to change without prior notice.  
In the absence of confirmation by device specification sheets, SHARP takes no responsibility for any defects that may occur in equipment using any SHARP devices shown in catalogs, data books, etc. Contact SHARP in order to obtain the latest device specification sheets before using any SHARP device.

**External Dimensions**

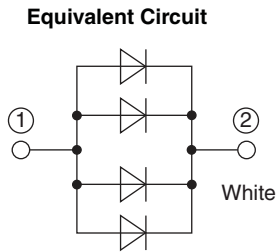
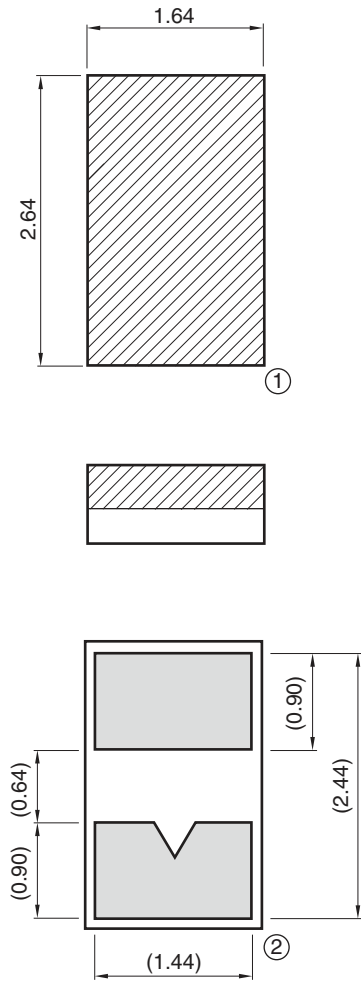

**Pin Arrangement**

No.	Name
①	Anode
②	Cathode

**NOTES:**

- 1. Units: mm
- 2. Unspecified tolerance:  $\pm 0.2$  mm
- 3. ( ): Reference dimensions

GM1BD78140A-1

**■ Absolute Maximum Ratings**

(Tc = 25°C)

Parameter	Symbol	Rating	Unit
Power dissipation	P	840	mW
Forward current *1	I <sub>F</sub>	200	mA
Reverse voltage	V <sub>R</sub>	-5	V
Operating temperature *2	T <sub>c</sub>	-30 to +85	°C
Storage temperature	T <sub>stg</sub>	-40 to +100	°C
Soldering temperature	T <sub>sol</sub>	250	°C

\*1 Operating Current values follow the Derating Curves.  
 \*2 Cathode temperature is measured on the back of the chip pad.  
 \*3 This device uses the solder pads for heat sinking, therefore the Operating Temperature range is prescribed by Tc.

**■ Electro-optical Characteristics**

(Tc = 25°C)

Parameter	Symbol	Conditions	MIN.	TYP.	MAX.	Unit
Forward voltage	V <sub>F</sub>	I <sub>F</sub> = 150 mA		3.5	4.2	V
Luminous intensity *1	I <sub>v</sub>		3.1	5.8		cd
Luminous flux	φ <sub>v</sub>		(13)	(24)		lm
Chromaticity coordinates *2	x			0.45		
	y		0.41			
Reverse current	I <sub>R</sub>	V <sub>R</sub> = 4 V			100	μA

\*1 Measured by EG&G Model 550 (Radiometer/Photometer) after 20 ms drive (Tolerance: ±15%). Also see *Luminous Intensity Ranking*.  
 \*2 Measured by Otsuka Electronics Model MCPD-2000 after 20 ms drive (Tolerance: x, y: ±0.02). Also see *Chromaticity Ranking*.  
 \*3 Parenthesis indicates reference values.

**■ Derating Curve**

**Fig. 1 Forward Current vs. Cathode Temperature**

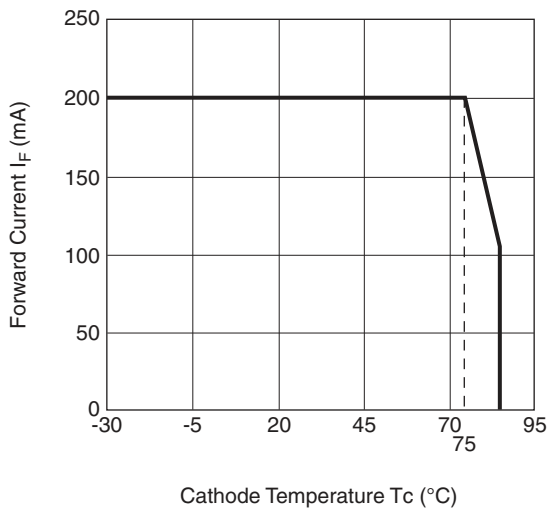

GM1BD78140A-3

**Fig. 2 Thermal Resistance**

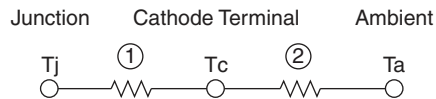

**NOTES:**

- ① Junction to Cathode: 25°C/W (Reference)
- ② Cathode to Ambient: Thermal resistance will vary depending on substrate structure

GM1BD78140A-4

**Characteristic Diagrams (TYP.\*)**

\*Characteristics data are typical data and are not guaranteed data.

**Fig. 3 Luminous Flux vs. Forward Current**

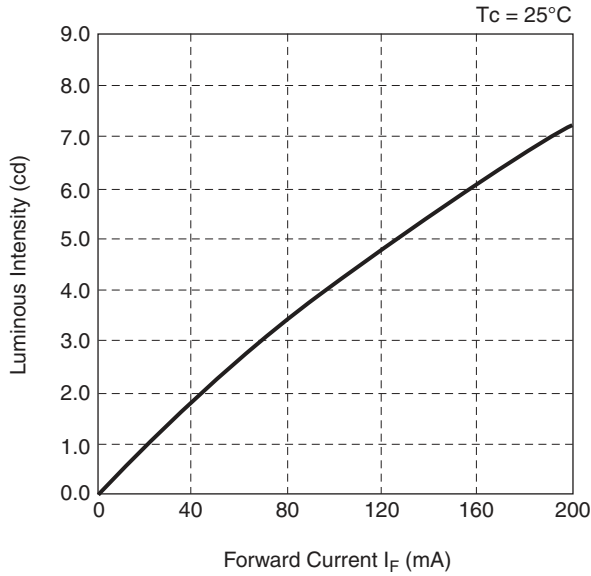

GM1BD78140A-5

**Fig. 4 Forward Current vs. Forward Voltage**

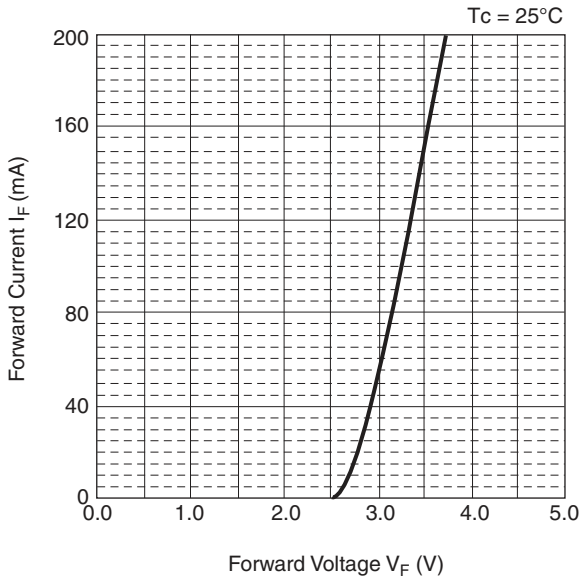

GM1BD78140A-6

**Fig. 5 Relative Luminous Intensity vs. Cathode Temperature**

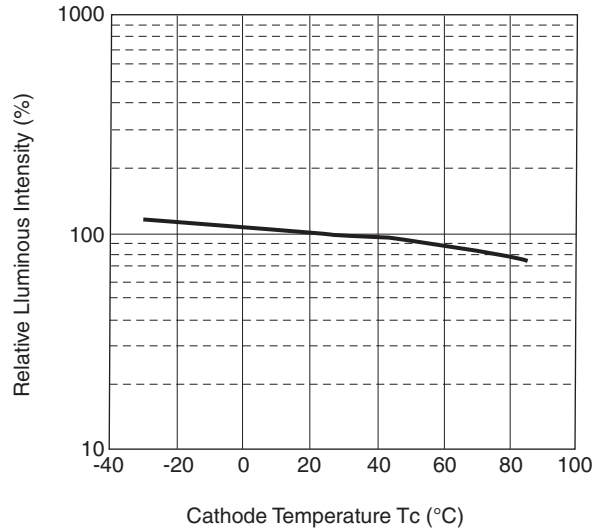

GM1BD78140A-7

**Fig. 6 Forward Voltage vs. Cathode Temperature**

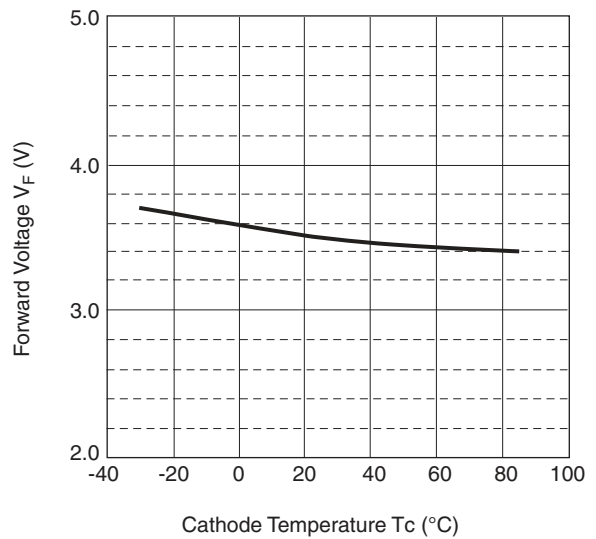

GM1BD78140A-8

**Fig. 7 Chromaticity vs. Cathode Temperature**

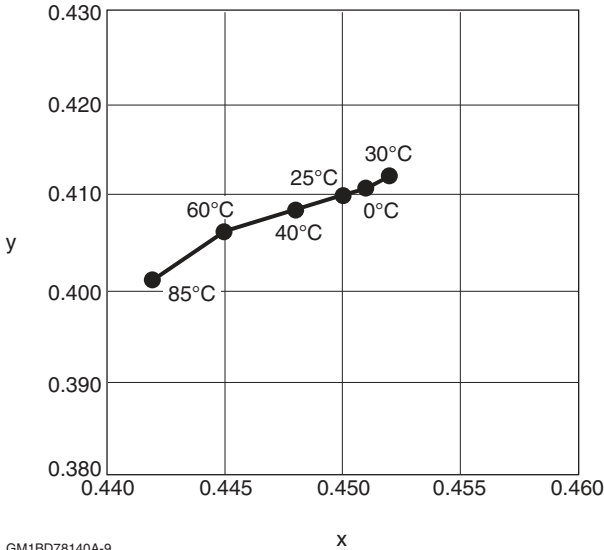

GM1BD78140A-9

**Fig. 8 Relative Intensity vs. Viewing Angle**

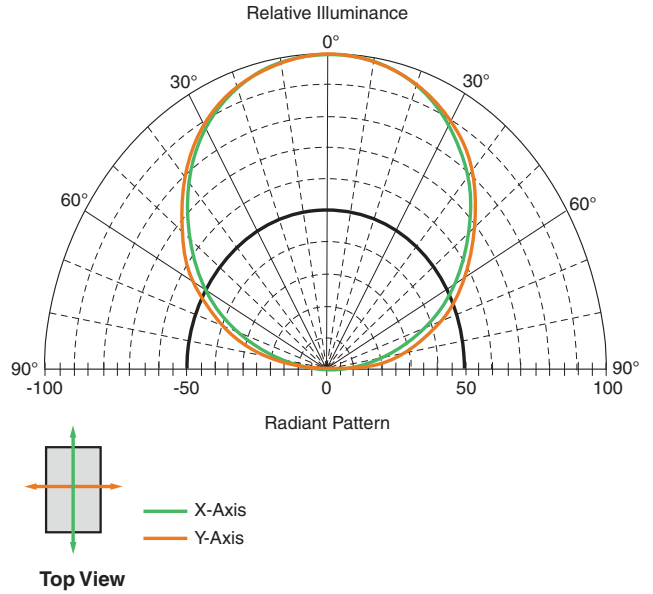

GM1BD78140A-10

**● Luminous Intensity Ranking**

Rank	Luminous Intensity	Unit	Condition
A	3.1 to 6.7	cd	$I_F = 150 \text{ mA}$
B	5.0 and up		

NOTE: Quantities in each ranking are decided by Sharp. Tolerance  $\pm 15\%$ .

**● Chromaticity Ranking**

Rank	Point 1		Point 2		Point 3		Point 4	
	x	y	x	y	x	y	x	y
a	0.432	0.433	0.417	0.396	0.403	0.389	0.415	0.425
b	0.451	0.441	0.433	0.403	0.417	0.396	0.432	0.433
c	0.473	0.448	0.452	0.409	0.433	0.403	0.451	0.441
d	0.496	0.453	0.473	0.413	0.452	0.409	0.473	0.448
e	0.522	0.455	0.496	0.415	0.473	0.413	0.496	0.453
f	0.417	0.396	0.403	0.363	0.391	0.358	0.403	0.389
g	0.433	0.403	0.417	0.369	0.403	0.363	0.417	0.396
h	0.452	0.409	0.433	0.374	0.417	0.369	0.433	0.403
j	0.473	0.413	0.452	0.378	0.433	0.374	0.452	0.409
k	0.496	0.415	0.472	0.380	0.452	0.378	0.473	0.413

NOTE: Quantities in each ranking are decided by Sharp. Tolerance  $\pm 0.02$

**Fig. 9 Chromaticity Diagram**

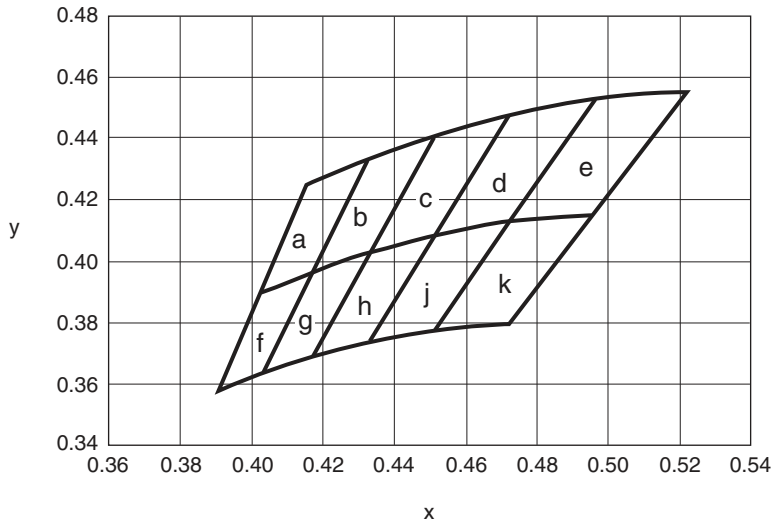

GM1BD78140A-2

**■ Tape Specifications**

**Fig. 10 Tape Shape and Dimensions**

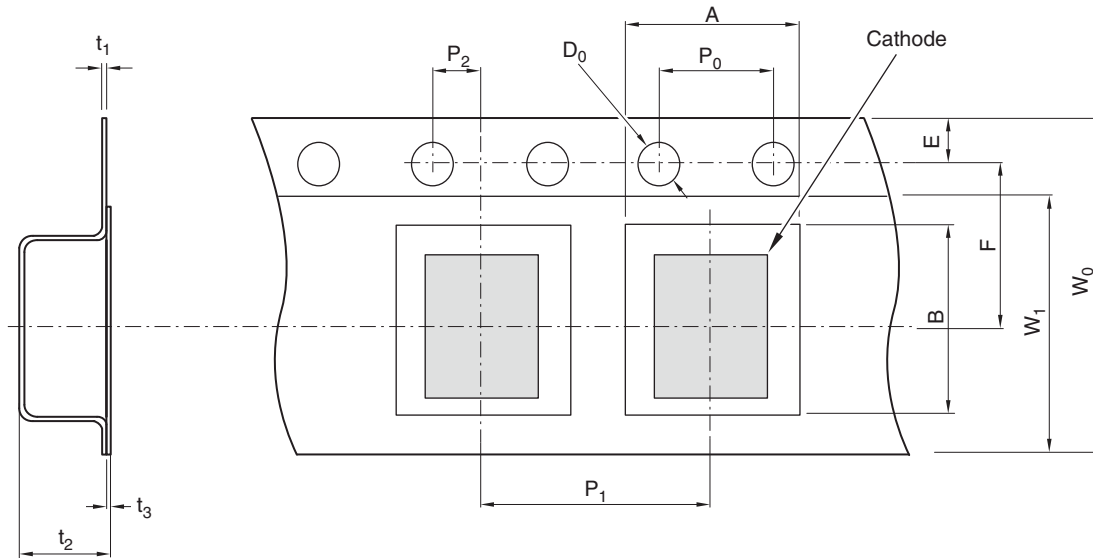

GM1BD78140A-13

**■ Tape Dimension Specifications**

Parameter	Symbol	Dimension (mm)	Remarks	
Concave rectangular pocket for parts insertion	Vertical	A	1.85	Dimension excludes corner R at the bottom inside
	Horizontal	B	2.85	
	Pitch	P <sub>1</sub>	4.0	
Sprocket hole	Diameter	D <sub>0</sub>	1.5	
	Pitch	P <sub>0</sub>	4.0	Accumulated error ±0.5 mm/10 pitch
	Position	E	1.75	Distance between the edge of the tape and center of the hole
Center to center distance	Vertical	P <sub>2</sub>	2.0	Distance between center line of the concave square hole and round sprocket hole
	Horizontal	F	3.5	
Cover tape	Width	W <sub>1</sub>	5.5	
	Thickness	t <sub>3</sub>	0.1	
Carrier tape	Width	W <sub>0</sub>	8.0	
	Thickness	t <sub>1</sub>	0.25	
Overall thickness	t <sub>2</sub>	1.3	Combines cover tape and carrier tape	

■ Reel Specifications

Fig. 11 Reel Shape and Dimensions

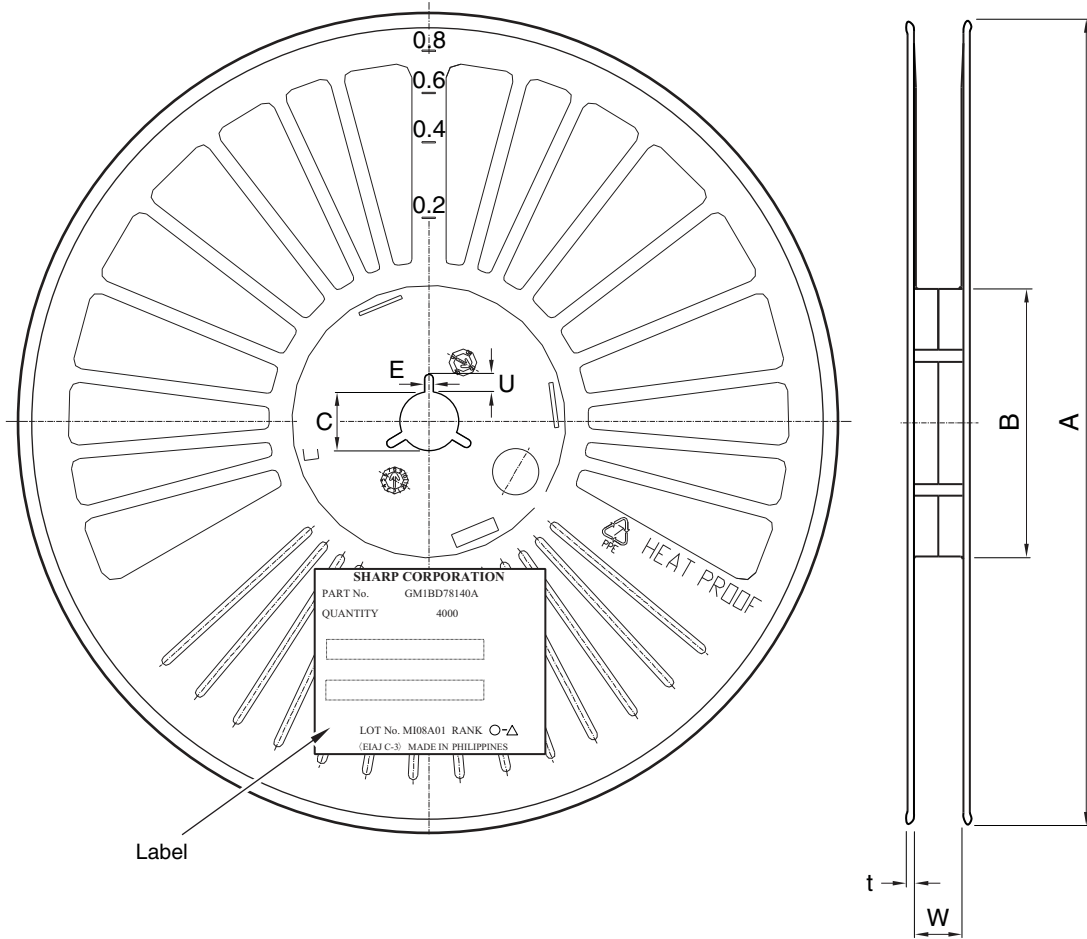

GM1BD78140A-14

■ Reel Dimension Specifications

	Parameter	Symbol	Dimension (mm)	Remarks
Flange	Diameter	A	180	
	Thickness	t	1.3	
	Flange spacing	W	9.5	Dimension of shaft core
Hub	External diameter	B	60	
	Spindle hole diameter	C	φ13	
	Key slit width	E	2.0	
	Key slit depth	U	4.0	

\*1 Label on side of flange: part name, quantity, lot number.

\*2 Material: described on flange.



**■ Taping Specifications**

1. Leader tape standard: JIS C0806

**Fig. 12 Leader Tape**

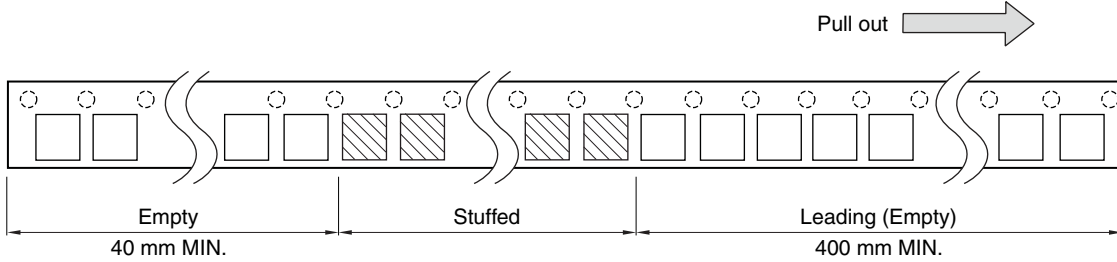

GM1BD78140A-15

2. Cover tape peel resistance:  $F = 0.1$  to  $1.0$  N ( $\theta = 10^\circ$  or less). See Fig. 10.

**Fig. 13 Tape Separation**

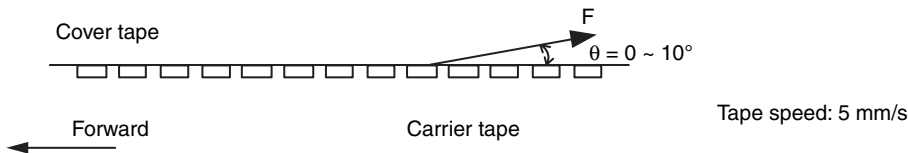

GM1BD78140A-16

3. Tape bending resistance: Cover tape will remain in place on radii of 30 mm or more. Under 30 mm radii, the cover may separate.
4. Joints are not allowed in the cover tape.
5. Parts are packed with an average quantity of 4000 pieces per reel.
6. Product mass: 8 mg (approximately)
7. Sharp guarantees the following:
  - a. No contiguous empty spaces in the tape
  - b. Missing parts will not make up more than 0.1% of the total quantity.
  - c. Parts will be easily removed from the packing.
8. Parts will not stick to the cover tape as it is peeled.

■ **Label and Marking Information**

**Fig. 14 Label Contents**

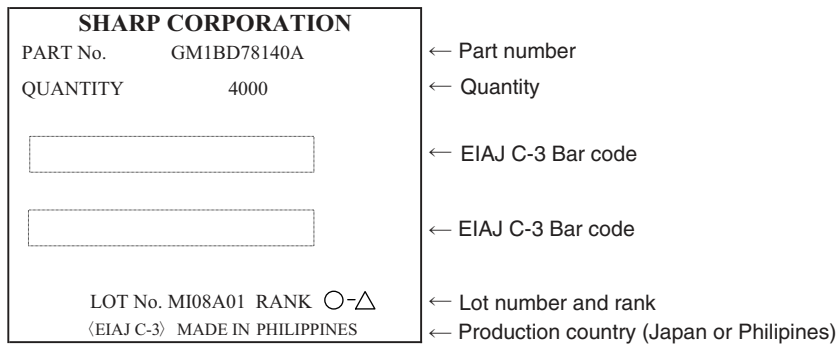

LOT Number

MI 08 A 01

① ② ③ ④

- ① Production plant code (alphabetically)
- ② Production year (the last two digits of the year)
- ③ Production month (alphabetically with January corresponding to A)
- ④ Production date (01 ~ 31)

Rank ○ △: ○: Luminous intensity rank

△: Chromaticity rank

GM1BD78140A-17

## ■ Design Notes

1. This product is not designed to resist electromagnetic and ionized-particle radiation. Moreover, it is not designed to directly resist excessive moisture, such as dew or condensation; or corrosive (salt) air or corrosive gases, such as Cl, H<sub>2</sub>S, NH<sub>3</sub>, SO<sub>2</sub>, NO<sub>x</sub>.
2. Do not allow the circuit design to apply any reverse voltage to the LEDs at any time, operating or not. Do not bias this part in any manner when it is not operating.
3. Sharp recommends using a constant-current supply to drive this part, as a constant-voltage supply may overdrive the part due to the lowering of V<sub>F</sub> as the part's temperature rises. If current beyond this part's maximum rating is allowed to flow through it, it may short-circuit; causing excess heat, smoke, or even fire. An overcurrent circuit is recommended to avoid this, as well as overvoltage protection. Always follow safety standards and regulations where this device will be applied.
4. This part can be easily damaged by external stress. Make sure it is not mechanically stressed during or after assembly. The emitting area is sealed with a silicone resin, which is particularly vulnerable to pressure from pick-and-place equipment. Excessive pressure applied to the sealing resin can cause the underlying structure of the part to debond or break entirely. Sharp recommends the use of a plastic collet (Teflon preferred) to protect parts from excess stress.
5. This product uses a blue LED chip in combination with yellow phosphor to achieve its color. There may be some color change caused by afterglow of the phosphor when driving this part with pulsed power. Heating and level of current when in operation may also change the color slightly. Verify this part's performance before use.
6. This part has exposed metal in bands along the side. See Fig. 15. Avoid touching this area when mounting it to the substrate, and do not allow other conductive elements from the design to contact it.

**Fig. 15 Non-contact Areas**

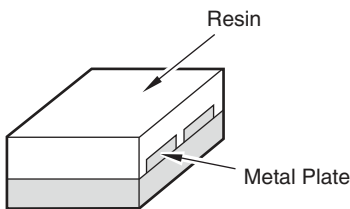

GM1BD78140A-19

7. This part has a very high light output. Looking directly at it during full power output can cause injury.
8. Sharp recommends taking proper personal and environmental static control precautions when handling this part.
9. Materials of high thermal conductivity are incorporated in this device to allow generated heat to be effectively transferred from it to the circuit board. For best reliability, Sharp recommends against locating other sources of heat near the LED, and to incorporate good thermal design practices and verification to maximize the part's life.
10. Sharp recommends handling these parts in a clean, non-dusty environment since surface dust may be difficult to remove and can affect the optical performance of the part.
11. Sharp recommends confirming the part's performance, reliability, and resistance to any of these conditions, if it is to be used in any of these environments:
  - Direct sunlight, outdoor exposure, dusty conditions
  - In water, oil, medical fluids, and organic solvents
  - Excessive moisture, such as dew or condensation
  - Corrosive (salt) air or corrosive gases, such as Cl, H<sub>2</sub>S, NH<sub>3</sub>, SO<sub>2</sub>, NO<sub>x</sub>

## ■ Manufacturing Guidelines

### ● Storage and Handling

1. Moisture-proofing: These parts are shipped in vacuum-sealed packaging to keep them dry and ready for use. See Fig. 16.

**Fig. 16 Factory Moisture-proof Packaging**

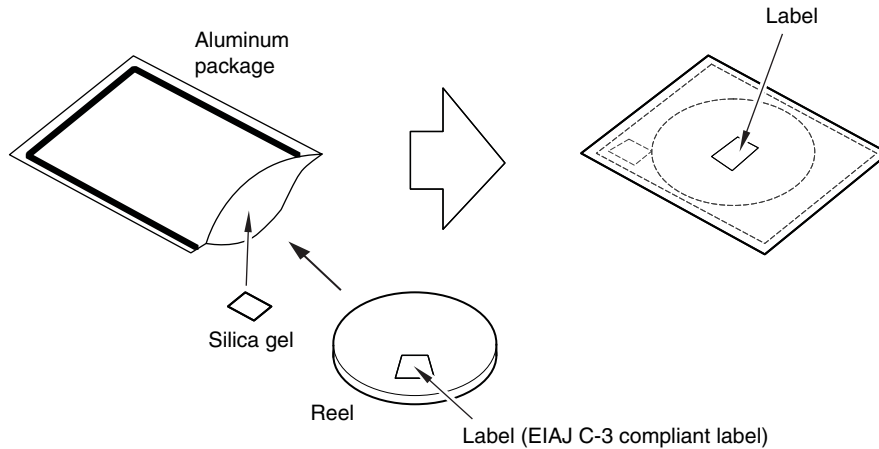

GM1BD78140A-18

2. Store these parts between 5°C and 30°C, at a relative humidity of less than 70%; for no longer than 1 year after the manufacture date.
3. After breaking the package seal, maintain the environment within 5°C to 30°C, at a relative humidity of less than 60%. Solder the parts within 3 days.
4. If the parts will not be used immediately, repack them in a dry box, or re-vacuum-seal them with a desiccant. Parts may be stored up to one year under these conditions.
5. If the parts are exposed to air for more than 3 days, or if the silica gel telltale indicates moisture contamination, bake the parts:
  - When in the tape carrier, bake them at a temperature of 60°C to 65°C, for 36 to 48 hours.
  - When loose or on a PCB, bake them at a temperature of 100°C to 120°C, for at least 12 hours.
  - Note that the reels may become distorted if they are in a stack when baking. Confirm that the parts have cooled to room temperature after baking.

## ● Cleaning Instructions

1. Sharp does not recommend cleaning printed circuit boards containing this device. Process chemicals will affect the structural and optical characteristics of this device.
2. Use solder paste that does not require cleaning.

## ● Soldering Instructions

1. When soldering with reflow methods, Sharp recommends following the soldering profile in Fig. 17.
2. Do not subject the package to excessive mechanical force during soldering as it may cause deformation or defects in plated connections. Internal connections may be severed due to mechanical force placed on the package due to the PCB flexing during the soldering process.
3. When using a second reflow, the second process should be carried out as soon as possible after the first, and within three days.
4. Electrodes on this part are silver-plated. If the part is exposed to a corrosive environment, the plating may be damaged, thereby affecting solderability.
5. The Reflow Profile shown in Fig. 17 should be considered as a set of maximum parameters. Since this part uses the leads for heatsinking, the peak temperature should be kept as cool as possible and the cooldown period lengthened as much as possible. Thermal conduction into the LED will be affected by the performance of the reflow process, so verification of the reflow process is recommended.
6. These parts may be used in a nitrogen reflow process, but may not be dip-soldered.

**Fig. 17 Temperature Profile**

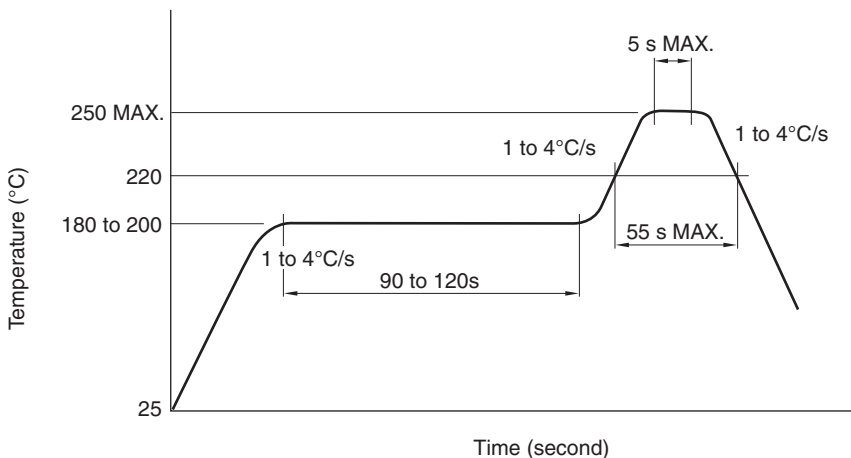

GM1BD78140A-20

7. When repairing boards containing this part, preheat it from room temperature at such a rate that it reaches 100°C after 90 s,  $\pm 30$  s; then solder at a temperature between 250°C and 260°C; and within 10 seconds.

### ● Recommended Solder Pad Design

1. Solderability depends on reflow conditions, solder paste, and circuit board materials. Check the entire process before production commences.
2. Fig. 18 shows the recommended solder pad design for this part.
3. When using a second reflow, Sharp recommends checking the process carefully: board warping from heat can cause mechanical failure in these parts, in addition to the high heat conducted into the part through the connections.

**Fig. 18 Recommended Solder Pad Design**

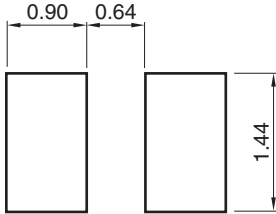

**NOTE:** Units: mm

GM1BD78140A-21

### ● Presence of ODCs

This product shall not contain the following materials, and they are not used in the production process for this product:

- Regulated substances: CFCs, Halon, Carbon tetrachloride, and 1,1,1-Trichloroethane (Methylchloroform). Specific brominated flame retardants such as the PBBOs and PBBs are not used in this product at all.

This product shall not contain the following materials banned in the RoHS Directive (2002/95/EC).

- Lead, Mercury, Cadmium, Hexavalent chromium, Polybrominated biphenyls (PBB), Polybrominated diphenyl ethers (PBDE).

## ■ Important Notices

· The circuit application examples in this publication are provided to explain representative applications of SHARP devices and are not intended to guarantee any circuit design or license any intellectual property rights. SHARP takes no responsibility for any problems related to any intellectual property right of a third party resulting from the use of SHARP's devices.

· Contact SHARP in order to obtain the latest device specification sheets before using any SHARP device. SHARP reserves the right to make changes in the specifications, characteristics, data materials, structure, and other contents described herein at any time without notice in order to improve design or reliability. Manufacturing locations are also subject to change without notice.

· Observe the following points when using any devices in this publication. SHARP takes no responsibility for damage caused by improper use of the devices which does not meet the conditions and absolute maximum ratings to be used specified in the relevant specification sheet nor meet the following conditions:

(i) The devices in this publication are designed for use in general electronic equipment designs such as:

- Personal computers
- Office automation equipment
- Telecommunication equipment (terminal)
- Test and measurement equipment
- Industrial control
- Audio visual equipment
- Consumer electronics

(ii) Measures such as fail-safe function and redundant design should be taken to ensure reliability and safety when SHARP devices are used for or in connection with equipment that requires higher reliability such as:

- Transportation control and safety equipment (i.e., aircraft, trains, automobiles, etc.)
- Traffic signals
- Gas leakage sensor breakers
- Alarm equipment
- Various safety devices, etc.

(iii) SHARP devices shall not be used for or in connection with equipment that requires an extremely high level of reliability and safety such as:

- Space applications
- Telecommunication equipment (trunk lines)
- Nuclear power control equipment
- Medical and other life support equipment (e.g. scuba)

· If the SHARP devices listed in this publication fall within the scope of strategic products described in the Foreign Exchange and Foreign Trade Law of Japan, it is necessary to obtain approval to export such SHARP devices.

· This publication is the proprietary product of SHARP and is copyrighted, with all rights reserved. Under the copyright laws, no part of this publication may be reproduced or transmitted in any form or by any means, electronic or mechanical, for any purpose, in whole or in part, without the express written permission of SHARP. Express written permission is also required before any use of this publication may be made by a third party.

· Contact and consult with a SHARP representative if there are any questions about the contents of this publication.