

MODEL: TBDR-07-25-GY | **DESCRIPTION:** DIN RAIL TERMINAL BLOCK

FEATURES

- DIN rail mount
- push-in spring
- 2.5 mm² wire size
- feed through
- UL and CE safety approvals



SPECIFICATIONS

parameter	conditions/description	min	typ	max	units
rated voltage (UL)	Use Group: B, C, D			600	V
rated current (UL)	Use Group: B, C D			20 5	A A
rated voltage (IEC)	Overvoltage Category/Pollution Degree: III/3 III/2, II/2			800 -	V
rated current (IEC)	Overvoltage Category/Pollution Degree: III/3 III/2, II/2			24 -	A
frequency voltage			2200		Vac
surge voltage				8000	V
voltage drop				3.2	mV
insulation resistance	at 500 Vdc	500			MΩ
operating temperature		-40		105	°C
safety approvals	UL 1059, IEC 60947-7-1				
flammability rating	UL94V-0				
RoHS	yes				

MECHANICAL DRAWING

units: mm
 tolerance:
 X≤6.00: ±0.25 mm
 6.00<X≤30.00: ±0.40 mm
 30.00<X≤60.00: ±0.60 mm
 60.00<X≤150.00: ±1.00 mm
 unless otherwise noted

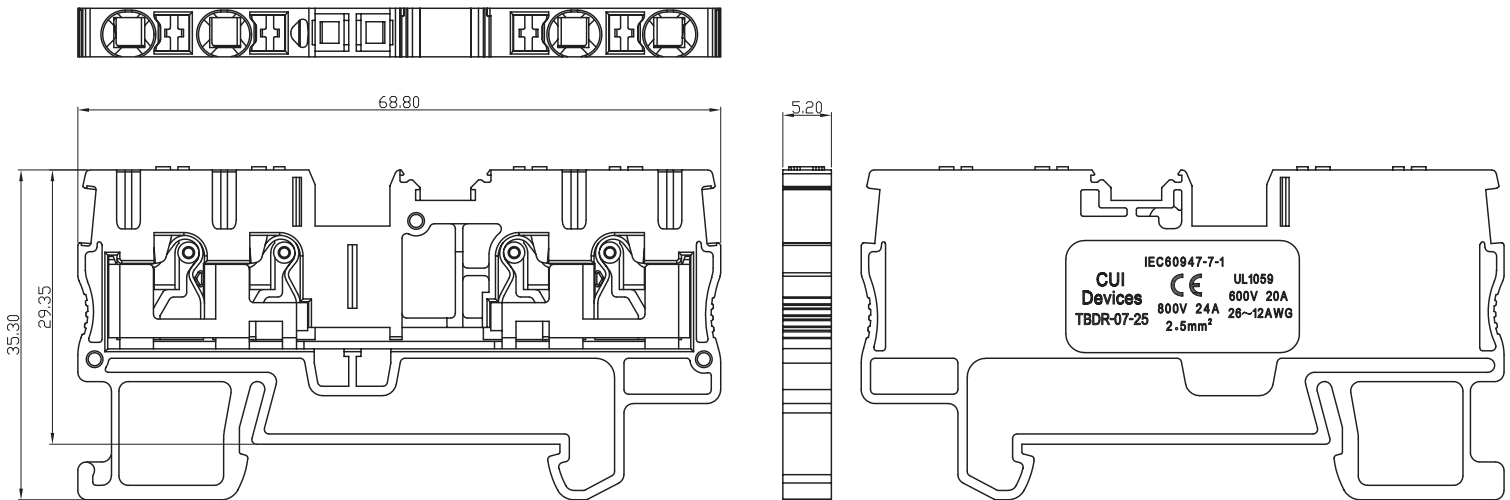
DESCRIPTION	MATERIAL	PLATING/COLOR
housing	PA66 (UL94V-0)	gray
contacts	copper alloy	tin
spring	stainless steel	



ASSEMBLY		
	UL	IEC
Wire Range	26-12 AWG	0.2-2.5 mm ²
Strip Length	10-12 mm	
Mounting Rail	TS 35/7.5, 15	

REVISION HISTORY

rev.	description	date
1.0	initial release	11/21/2022

The revision history provided is for informational purposes only and is believed to be accurate.



CUI Devices offers a one (1) year limited warranty. Complete warranty information is listed on our website.

CUI Devices reserves the right to make changes to the product at any time without notice. Information provided by CUI Devices is believed to be accurate and reliable. However, no responsibility is assumed by CUI Devices for its use, nor for any infringements of patents or other rights of third parties which may result from its use.

CUI Devices products are not authorized or warranted for use as critical components in equipment that requires an extremely high level of reliability. A critical component is any component of a life support device or system whose failure to perform can be reasonably expected to cause the failure of the life support device or system, or to affect its safety or effectiveness.

cuidevices.com