

CC2650MODA SimpleLink™ *Bluetooth*® low energy Wireless MCU Module

1 Device Overview

1.1 Features

- Microcontroller
 - Powerful ARM® Cortex®-M3
 - EEMBC CoreMark® Score: 142
 - Up to 48-MHz Clock Speed
 - 128KB of In-System Programmable Flash
 - 8KB of SRAM for Cache
 - 20KB of Ultra-Low-Leakage SRAM
 - 2-Pin cJTAG and JTAG Debugging
 - Supports Over-The-Air (OTA) Upgrade
- Ultra-Low-Power Sensor Controller
 - Can Run Autonomous From the Rest of the System
 - 16-Bit Architecture
 - 2KB of Ultra-Low-Leakage SRAM for Code and Data
- Efficient Code Size Architecture, Placing Drivers, *Bluetooth*® low energy Controller, IEEE® 802.15.4 Medium Access Control (MAC), and Bootloader in ROM
- Integrated Antenna
- Peripherals
 - All Digital Peripheral Pins Can Be Routed to Any GPIO
 - Four General-Purpose Timer Modules (8 × 16-Bit or 4 × 32-Bit Timer, PWM Each)
 - 12-Bit ADC, 200-ksamples/s, 8-Channel Analog MUX
 - Continuous Time Comparator
 - Ultra-Low-Power Analog Comparator
 - Programmable Current Source
 - UART
 - 2 × SSI (SPI, MICROWIRE, TI)
 - I²C
 - I2S
 - Real-Time Clock (RTC)
 - AES-128 Security Module
 - True Random Number Generator (TRNG)
 - 15 GPIOs
 - Support for Eight Capacitive Sensing Buttons
 - Integrated Temperature Sensor
- External System
 - On-Chip Internal DC-DC Converter
 - No External Components Needed, Only Supply Voltage
- Low Power
 - Wide Supply Voltage Range
 - Operation from 1.8 to 3.8 V
 - Active-Mode RX: 6.2 mA
 - Active-Mode TX at 0 dBm: 6.8 mA
 - Active-Mode TX at +5 dBm: 9.4 mA
 - Active-Mode MCU: 61 μA/MHz
 - Active-Mode MCU: 48.5 CoreMark/mA
 - Active-Mode Sensor Controller: 0.4 mA + 8.2 μA/MHz
 - Standby: 1 μA (RTC Running and RAM/CPU Retention)
 - Shutdown: 100 nA (Wake Up on External Events)
- RF Section
 - 2.4-GHz RF Transceiver Compatible With Bluetooth low energy (BLE) 5.1 Specification and IEEE 802.15.4 PHY and MAC
 - CC2650MODA RF-PHY Qualified (QDID: 88415)
 - Excellent Receiver Sensitivity (–97 dBm for Bluetooth low energy and –100 dBm for 802.15.4), Selectivity, and Blocking Performance
 - Programmable Output Power up to +5 dBm
 - Pre-certified for Compliance With Worldwide Radio Frequency Regulations
 - ETSI RED (Europe)
 - IC (Canada)
 - FCC (USA)
 - ARIB STD-T66 (Japan)
 - JATE (Japan)
- Tools and Development Environment
 - Full-Feature and Low-Cost Development Kits
 - Multiple Reference Designs for Different RF Configurations
 - Packet Sniffer PC Software
 - Sensor Controller Studio
 - SmartRF™ Studio
 - SmartRF Flash Programmer 2
 - IAR Embedded Workbench® for ARM
 - Code Composer Studio™



1.2 Applications

- Building Automation
- Medical and Health
- Appliances
- Industrial
- Consumer Electronics
- Proximity Tags
- Alarm and Security
- Remote Controls
- Wireless Sensor Networks

1.3 Description

The SimpleLink™ CC2650MODA device is a wireless microcontroller (MCU) module that targets *Bluetooth*® low energy applications. The CC2650MODA device can also run ZigBee® and 6LoWPAN and ZigBee RF4CE™ remote control applications.

The module is based on the SimpleLink CC2650 wireless MCU, a member of the CC26xx family of cost-effective, ultra-low-power, 2.4-GHz RF devices. Very-low active RF and MCU current and low-power mode current consumption provide excellent battery lifetime and allow for operation on small coin-cell batteries and in energy-harvesting applications.

The CC2650MODA module contains a 32-bit ARM Cortex-M3 processor that runs at 48 MHz as the main processor and a rich peripheral feature set that includes a unique ultra-low-power sensor controller. This sensor controller is good for interfacing with external sensors or for collecting analog and digital data autonomously while the rest of the system is in sleep mode. Thus, the CC2650MODA device is good for applications within a wide range of products including industrial, consumer electronics, and medical devices.

The CC2650MODA module is pre-certified for operation under the regulations of the FCC, IC, ETSI, and ARIB. These certifications save significant cost and effort for customers when integrating the module into their products.

The Bluetooth low energy controller and the IEEE 802.15.4 MAC are embedded in the ROM and are partly running on a separate ARM® Cortex®-M0 processor. This architecture improves overall system performance and power consumption and makes more flash memory available.

The Bluetooth low energy software stack ([BLE-Stack](#)) and the ZigBee software stack ([Z-Stack™](#)) are available free of charge.

Device Information⁽¹⁾

PART NUMBER	PACKAGE	BODY SIZE
CC2650MODAMOH	MOH (Module)	16.90 mm × 11.00 mm

(1) For more information, see [Section 10](#).

1.4 Functional Block Diagram

Figure 1-1 is a block diagram for the CC2650MODA device.

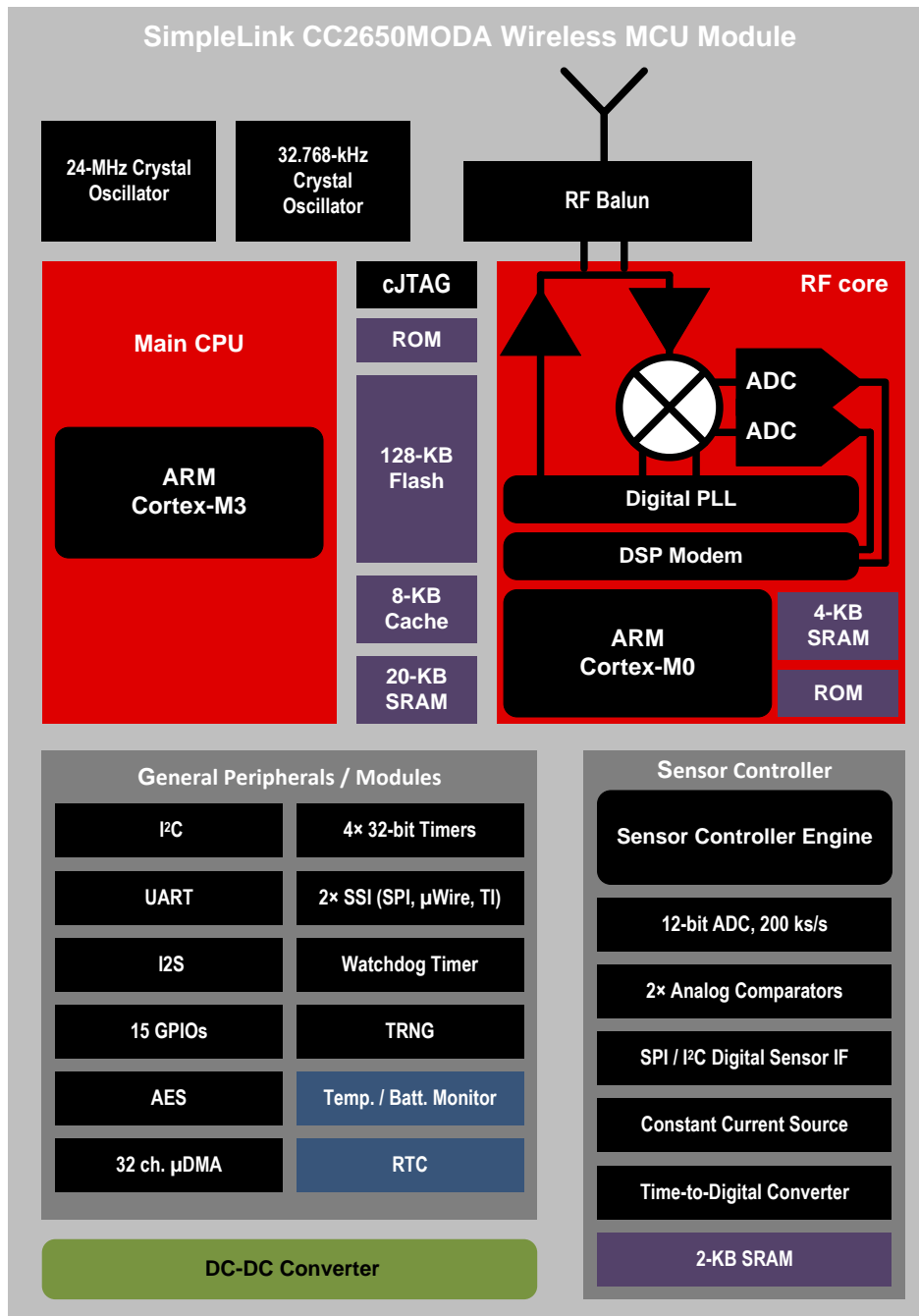

Copyright © 2017, Texas Instruments Incorporated

Figure 1-1. CC2650MODA Block Diagram

Table of Contents

1	Device Overview	1	6.2	Functional Block Diagram	24
1.1	Features	1	6.3	Main CPU	25
1.2	Applications	2	6.4	RF Core	25
1.3	Description	2	6.5	Sensor Controller	26
1.4	Functional Block Diagram	3	6.6	Memory	27
2	Revision History	5	6.7	Debug	27
3	Device Comparison	6	6.8	Power Management	28
3.1	Related Products	6	6.9	Clock Systems	29
4	Terminal Configuration and Functions	7	6.10	General Peripherals and Modules	29
4.1	Module Pin Diagram	7	6.11	System Architecture	30
4.2	Pin Functions	8	6.12	Certification	30
5	Specifications	9	6.13	End Product Labeling	32
5.1	Absolute Maximum Ratings	9	6.14	Manual Information to the End User	32
5.2	ESD Ratings	9	6.15	Module Marking	33
5.3	Recommended Operating Conditions	9	7	Application, Implementation, and Layout	34
5.4	Power Consumption Summary	10	7.1	Application Information	34
5.5	General Characteristics	10	7.2	Layout	35
5.6	Antenna	11	8	Environmental Requirements and Specifications	36
5.7	1-Mbps GFSK (Bluetooth low energy) – RX	11	8.1	PCB Bending	36
5.8	1-Mbps GFSK (Bluetooth low energy) – TX	12	8.2	Handling Environment	36
5.9	IEEE 802.15.4 (Offset Q-PSK DSSS, 250 kbps) – RX	12	8.3	Storage Condition	36
5.10	IEEE 802.15.4 (Offset Q-PSK DSSS, 250 kbps) – TX	13	8.4	Baking Conditions	36
5.11	24-MHz Crystal Oscillator (XOSC_HF)	13	8.5	Soldering and Reflow Condition	37
5.12	32.768-kHz Crystal Oscillator (XOSC_LF)	13	9	Device and Documentation Support	38
5.13	48-MHz RC Oscillator (RCOSC_HF)	13	9.1	Device Nomenclature	38
5.14	32-kHz RC Oscillator (RCOSC_LF)	13	9.2	Tools and Software	39
5.15	ADC Characteristics	14	9.3	Documentation Support	40
5.16	Temperature Sensor	15	9.4	Texas Instruments Low-Power RF Website	40
5.17	Battery Monitor	15	9.5	Low-Power RF eNewsletter	40
5.18	Continuous Time Comparator	15	9.6	Community Resources	41
5.19	Low-Power Clocked Comparator	15	9.7	Additional Information	41
5.20	Programmable Current Source	16	9.8	Trademarks	41
5.21	DC Characteristics	16	9.9	Electrostatic Discharge Caution	42
5.22	Thermal Resistance Characteristics for MOH Package	17	9.10	Export Control Notice	42
5.23	Timing Requirements	17	9.11	Glossary	42
5.24	Switching Characteristics	17	10	Mechanical, Packaging, and Orderable Information	42
5.25	Typical Characteristics	20	10.1	Packaging Information	42
6	Detailed Description	24	10.2	PACKAGE OPTION ADDENDUM	43
6.1	Overview	24	10.3	PACKAGE MATERIALS INFORMATION	44

2 Revision History

NOTE: Page numbers for previous revisions may differ from page numbers in the current version.

Changes from July 1, 2017 to July 31, 2019	Page
• Added Module Marking section.	33
• Added Environmental Requirements and Specifications section.	36

3 Device Comparison

Table 3-1. Device Family Overview

DEVICE	PHY SUPPORT	FLASH (KB)	RAM (KB)	GPIO	PACKAGE
CC2650MODAMOH	Multiprotocol ⁽¹⁾	128	20	15	MOH

(1) The CC2650 device supports all PHYs and can be reflashed to run all the supported standards.

3.1 Related Products

TI's Wireless Connectivity The wireless connectivity portfolio offers a wide selection of low-power RF solutions suitable for a broad range of applications. The offerings range from fully customized solutions to turn key offerings with pre-certified hardware and software (protocol).

TI's SimpleLink™ Sub-1 GHz Wireless MCUs Long-range, low-power wireless connectivity solutions are offered in a wide range of Sub-1 GHz ISM bands.

Companion Products Review products that are frequently purchased or used in conjunction with this product.

SimpleLink™ CC2650 Wireless MCU LaunchPad™ Development Kit The CC2650 LaunchPad™ development kit brings easy Bluetooth® low energy connectivity to the LaunchPad kit ecosystem with the SimpleLink ultra-low power CC26xx family of devices. This LaunchPad kit also supports development for multi-protocol support for the SimpleLink multi-standard CC2650 wireless MCU and the rest of CC26xx family of products: CC2630 wireless MCU for ZigBee®/6LoWPAN and CC2640 wireless MCU for Bluetooth low energy.

Reference Designs for CC2650MODA TI Designs Reference Design Library is a robust reference design library spanning analog, embedded processor and connectivity. Created by TI experts to help you jump-start your system design, all TI Designs include schematic or block diagrams, BOMs, and design files to speed your time to market. Search and download designs at ti.com/tidesigns.

4 Terminal Configuration and Functions

Section 4.1 shows pin assignments for the CC2650MODA device.

4.1 Module Pin Diagram

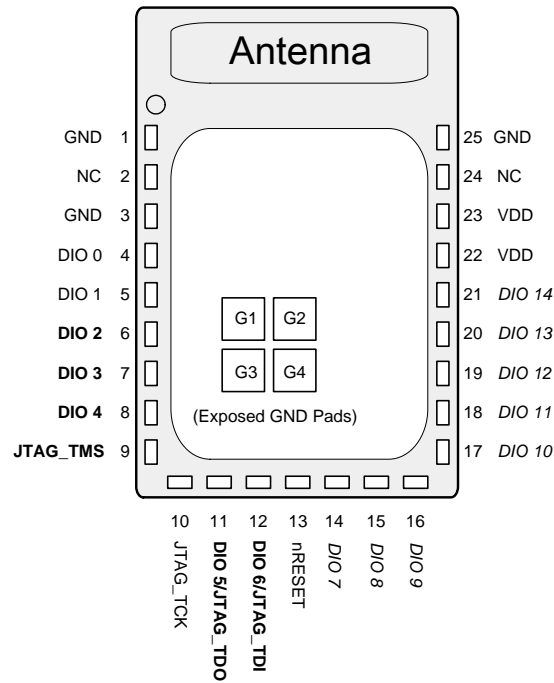

(1) The following I/O pins marked in **bold** in the pinout have high-drive capabilities:

- DIO 2
- DIO 3
- DIO 4
- JTAG_TMS
- DIO 5/JTAG_TDO
- DIO 6/JTAG_TDI

(2) The following I/O pins marked in *italics* in the pinout have analog capabilities:

- DIO 7
- DIO 8
- DIO 9
- DIO 10
- DIO 11
- DIO 12
- DIO 13
- DIO 14

**Figure 4-1. CC2650MODA MOH Package
(16.9-mm × 11-mm) Module Pinout**

4.2 Pin Functions

Table 4-1 describes the CC2650MODA pins.

Table 4-1. Signal Descriptions – MOH Package

PIN NAME	PIN NO.	PIN TYPE	DESCRIPTION
DIO_0	4	Digital I/O	GPIO, Sensor Controller
DIO_1	5	Digital I/O	GPIO, Sensor Controller
DIO_2	6	Digital I/O	GPIO, Sensor Controller, high-drive capability
DIO_3	7	Digital I/O	GPIO, Sensor Controller, high-drive capability
DIO_4	8	Digital I/O	GPIO, Sensor Controller, high-drive capability
DIO_5/JTAG_TDO	11	Digital I/O	GPIO, high-drive capability, JTAG_TDO
DIO_6/JTAG_TDI	12	Digital I/O	GPIO, high-drive capability, JTAG_TDI
DIO_7	14	Digital I/O, Analog I/O	GPIO, Sensor Controller, analog
DIO_8	15	Digital I/O, Analog I/O	GPIO, Sensor Controller, analog
DIO_9	16	Digital I/O, Analog I/O	GPIO, Sensor Controller, analog
DIO_10	17	Digital I/O, Analog I/O	GPIO, Sensor Controller, analog
DIO_11	18	Digital I/O, Analog I/O	GPIO, Sensor Controller, analog
DIO_12	19	Digital I/O, Analog I/O	GPIO, Sensor Controller, analog
DIO_13	20	Digital I/O, Analog I/O	GPIO, Sensor Controller, analog
DIO_14	21	Digital I/O, Analog I/O	GPIO, Sensor Controller, analog
EGP	G1, G2, G3, G4	Power	Ground – Exposed ground pad
GND	1, 3, 25	—	Ground
JTAG_TCK	10	Digital I/O	JTAG TCKC
JTAG_TMS	9	Digital I/O	JTAG TMSC, high-drive capability
NC	2, 24	NC	Not Connected—TI recommends leaving these pins floating
nRESET	13	Digital input	Reset, active low. No internal pullup
VDD	22, 23	Power	1.8-V to 3.8-V main chip supply

5 Specifications

5.1 Absolute Maximum Ratings

over operating free-air temperature range (unless otherwise noted)⁽¹⁾⁽²⁾

		MIN	MAX	UNIT
VDD	Supply voltage	-0.3	4.1	V
	Voltage on any digital pin ⁽³⁾	-0.3	VDD + 0.3, max 4.1	V
V _{in}	Voltage on ADC input	Voltage scaling enabled	VDD	V
		Voltage scaling disabled, internal reference	1.49	
		Voltage scaling disabled, VDD as reference	VDD / 2.9	
	Input RF level		5	dBm
T _{stg}	Storage temperature	-40	85	°C

- (1) Stresses beyond those listed under *Absolute Maximum Ratings* may cause permanent damage to the device. These are stress ratings only, and functional operation of the device at these or any other conditions beyond those indicated under *Recommended Operating Conditions* is not implied. Exposure to absolute-maximum-rated conditions for extended periods may affect device reliability.
- (2) All voltage values are with respect to ground, unless otherwise noted.
- (3) Including analog capable DIO.

5.2 ESD Ratings

			VALUE	UNIT	
V _{ESD}	Electrostatic discharge	Human body model (HBM), per ANSI/ESDA/JEDEC JS001 ⁽¹⁾	All pins	±1000	V
		Charged device model (CDM), per JESD22-C101 ⁽²⁾	RF pins	±500	
			Non-RF pins	±500	

- (1) JEDEC document JEP155 states that 500-V HBM allows safe manufacturing with a standard ESD control process.
- (2) JEDEC document JEP157 states that 250-V CDM allows safe manufacturing with a standard ESD control process.

5.3 Recommended Operating Conditions

		MIN	MAX	UNIT
Ambient temperature		-40	85	°C
Operating supply voltage (VDD)	For operation in battery-powered and 3.3-V systems (internal DC-DC can be used to minimize power consumption)	1.8	3.8	V

5.4 Power Consumption Summary

$T_c = 25^\circ\text{C}$, $V_{DD} = 3.0\text{ V}$ with internal DC-DC converter, unless otherwise noted

PARAMETER		TEST CONDITIONS	MIN	TYP	MAX	UNIT	
I_{core}	Core current consumption	Reset. RESET_N pin asserted or VDD below Power-on-Reset threshold		100		nA	
		Shutdown. No clocks running, no retention		150			
		Standby. With RTC, CPU, RAM and (partial) register retention. RCOSC_LF			1		μA
		Standby. With RTC, CPU, RAM and (partial) register retention. XOSC_LF			1.2		
		Standby. With Cache, RTC, CPU, RAM and (partial) register retention. RCOSC_LF			2.5		
		Standby. With Cache, RTC, CPU, RAM and (partial) register retention. XOSC_LF			2.7		
		Idle. Supply systems and RAM powered.			550		
		Active. Core running CoreMark			1.45 mA + 31 $\mu\text{A}/\text{MHz}$		
		Radio RX			6.2		mA
		Radio TX, 0-dBm output power			6.8		
Radio TX, 5-dBm output power			9.4				
Peripheral Current Consumption (Adds to core current I_{core} for each peripheral unit activated) ⁽¹⁾							
I_{peri}	Peripheral power domain	Delta current with domain enabled		20		μA	
	Serial power domain	Delta current with domain enabled		13			
	RF core	Delta current with power domain enabled, clock enabled, RF Core Idle		237			
	μDMA	Delta current with clock enabled, module idle		130			
	Timers	Delta current with clock enabled, module idle		113			
	$I^2\text{C}$	Delta current with clock enabled, module idle		12			
	I2S	Delta current with clock enabled, module idle		36			
	SSI	Delta current with clock enabled, module idle		93			
	UART	Delta current with clock enabled, module idle		164			

(1) I_{peri} is not supported in Standby or Shutdown.

5.5 General Characteristics

$T_c = 25^\circ\text{C}$, $V_{DD} = 3.0\text{ V}$, unless otherwise noted

PARAMETER	TEST CONDITIONS	MIN	TYP	MAX	UNIT
FLASH MEMORY					
Supported flash erase cycles before failure		100			k Cycles
Flash page/sector erase current	Average delta current		12.6		mA
Flash page/sector erase time ⁽¹⁾			8		ms
Flash page/sector size			4		KB
Flash write current	Average delta current, 4 bytes at a time		8.15		mA
Flash write time ⁽¹⁾	4 bytes at a time		8		μs

(1) This number is dependent on flash aging and will increase over time and erase cycles.

5.6 Antenna

$T_c = 25^\circ\text{C}$, $V_{DD} = 3.0\text{ V}$, unless otherwise noted.

PARAMETER	TEST CONDITIONS	MIN	TYP	MAX	UNIT
Polarization			Linear		
Peak Gain	2450 MHz		1.26		dBi
Efficiency	2450 MHz		57%		

5.7 1-Mbps GFSK (Bluetooth low energy) – RX

RF performance is specified in a single ended 50- Ω reference plane at the antenna feeding point with $T_c = 25^\circ\text{C}$, $V_{DD} = 3.0\text{ V}$, $f_{RF} = 2440\text{ MHz}$, unless otherwise noted.

PARAMETER	TEST CONDITIONS	MIN	TYP	MAX	UNIT
Receiver sensitivity	BER = 10^{-3}		-97		dBm
Receiver saturation	BER = 10^{-3}		4		dBm
Frequency error tolerance	Difference between center frequency of the received RF signal and local oscillator frequency.	-350		350	kHz
Data rate error tolerance		-750		750	ppm
Co-channel rejection ⁽¹⁾	Wanted signal at -67 dBm, modulated interferer in channel, BER = 10^{-3}		-6		dB
Selectivity, $\pm 1\text{ MHz}$ ⁽¹⁾	Wanted signal at -67 dBm, modulated interferer at $\pm 1\text{ MHz}$, BER = 10^{-3}		7 / 3 ⁽²⁾		dB
Selectivity, $\pm 2\text{ MHz}$ ⁽¹⁾	Wanted signal at -67 dBm, modulated interferer at $\pm 2\text{ MHz}$, BER = 10^{-3}		29 / 23 ⁽²⁾		dB
Selectivity, $\pm 3\text{ MHz}$ ⁽¹⁾	Wanted signal at -67 dBm, modulated interferer at $\pm 3\text{ MHz}$, BER = 10^{-3}		38 / 26 ⁽²⁾		dB
Selectivity, $\pm 4\text{ MHz}$ ⁽¹⁾	Wanted signal at -67 dBm, modulated interferer at $\pm 4\text{ MHz}$, BER = 10^{-3}		42 / 29 ⁽²⁾		dB
Selectivity, $\pm 5\text{ MHz}$ or more ⁽¹⁾	Wanted signal at -67 dBm, modulated interferer at $\geq \pm 5\text{ MHz}$, BER = 10^{-3}		32		dB
Selectivity, Image frequency ⁽¹⁾	Wanted signal at -67 dBm, modulated interferer at image frequency, BER = 10^{-3}		23		dB
Selectivity, Image frequency $\pm 1\text{ MHz}$ ⁽¹⁾	Wanted signal at -67 dBm, modulated interferer at $\pm 1\text{ MHz}$ from image frequency, BER = 10^{-3}		3 / 26 ⁽²⁾		dB
Out-of-band blocking ⁽³⁾	30 MHz to 2000 MHz		-20		dBm
Out-of-band blocking	2003 MHz to 2399 MHz		-5		dBm
Out-of-band blocking	2484 MHz to 2997 MHz		-8		dBm
Out-of-band blocking	3000 MHz to 12.75 GHz		-8		dBm
Intermodulation	Wanted signal at 2402 MHz, -64 dBm. Two interferers at 2405 and 2408 MHz respectively, at the given power level		-34		dBm
Spurious emissions, 30 MHz to 1000 MHz	Conducted measurement in a 50- Ω single-ended load. Suitable for systems targeting compliance with EN 300 328, EN 300 440 class 2, FCC CFR47, Part 15 and ARIB STD-T-66		-71		dBm
Spurious emissions, 1 GHz to 12.75 GHz	Conducted measurement in a 50- Ω single-ended load. Suitable for systems targeting compliance with EN 300 328, EN 300 440 class 2, FCC CFR47, Part 15 and ARIB STD-T-66		-62		dBm
RSSI dynamic range			70		dB
RSSI accuracy			± 4		dB

(1) Numbers given as I/C dB

(2) X / Y, where X is +N MHz and Y is -N MHz

(3) Excluding one exception at $F_{\text{wanted}} / 2$, per Bluetooth Specification

5.8 1-Mbps GFSK (Bluetooth low energy) – TX

RF performance is specified in a single ended 50- Ω reference plane at the antenna feeding point with $T_c = 25^\circ\text{C}$, $V_{DD} = 3.0\text{ V}$, $f_{RF} = 2440\text{ MHz}$, unless otherwise noted.

PARAMETER	TEST CONDITIONS	MIN	TYP	MAX	UNIT
Output power, highest setting			5		dBm
Output power, lowest setting			-21		dBm
Spurious emission conducted measurement ⁽¹⁾	f < 1 GHz, outside restricted bands		-43		dBm
	f < 1 GHz, restricted bands ETSI		-58		
	f < 1 GHz, restricted bands FCC		-57		
	f > 1 GHz, including harmonics		-45		

(1) Suitable for systems targeting compliance with worldwide radio-frequency regulations ETSI EN 300 328 and EN 300 440 Class 2 (Europe), FCC CFR47 Part 15 (US), and ARIB STD-T66 (Japan)

5.9 IEEE 802.15.4 (Offset Q-PSK DSSS, 250 kbps) – RX

RF performance is specified in a single ended 50- Ω reference plane at the antenna feeding point with $T_c = 25^\circ\text{C}$, $V_{DD} = 3.0\text{ V}$, unless otherwise noted.

PARAMETER	TEST CONDITIONS	MIN	TYP	MAX	UNIT
Receiver sensitivity	PER = 1%		-100		dBm
Receiver saturation	PER = 1%		-7		dBm
Adjacent channel rejection	Wanted signal at -82 dBm, modulated interferer at $\pm 5\text{ MHz}$, PER = 1%		35		dB
Alternate channel rejection	Wanted signal at -82 dBm, modulated interferer at $\pm 10\text{ MHz}$, PER = 1%		52		dB
Channel rejection, $\pm 15\text{ MHz}$ or more	Wanted signal at -82 dBm, undesired signal is IEEE 802.15.4 modulated channel, stepped through all channels 2405 to 2480 MHz, PER = 1%		57		dB
Blocking and desensitization, 5 MHz from upper band edge	Wanted signal at -97 dBm (3 dB above the sensitivity level), CW jammer, PER = 1%		64		dB
Blocking and desensitization, 10 MHz from upper band edge	Wanted signal at -97 dBm (3 dB above the sensitivity level), CW jammer, PER = 1%		64		dB
Blocking and desensitization, 20 MHz from upper band edge	Wanted signal at -97 dBm (3 dB above the sensitivity level), CW jammer, PER = 1%		65		dB
Blocking and desensitization, 50 MHz from upper band edge	Wanted signal at -97 dBm (3 dB above the sensitivity level), CW jammer, PER = 1%		68		dB
Blocking and desensitization, -5 MHz from lower band edge	Wanted signal at -97 dBm (3 dB above the sensitivity level), CW jammer, PER = 1%		63		dB
Blocking and desensitization, -10 MHz from lower band edge	Wanted signal at -97 dBm (3 dB above the sensitivity level), CW jammer, PER = 1%		63		dB
Blocking and desensitization, -20 MHz from lower band edge	Wanted signal at -97 dBm (3 dB above the sensitivity level), CW jammer, PER = 1%		65		dB
Blocking and desensitization, -50 MHz from lower band edge	Wanted signal at -97 dBm (3 dB above the sensitivity level), CW jammer, PER = 1%		67		dB
Spurious emissions, 30 MHz to 1000 MHz	Conducted measurement in a 50- Ω single-ended load. Suitable for systems targeting compliance with EN 300 328, EN 300 440 class 2, FCC CFR47, Part 15 and ARIB STD-T-66		-71		dBm
Spurious emissions, 1 GHz to 12.75 GHz	Conducted measurement in a 50- Ω single-ended load. Suitable for systems targeting compliance with EN 300 328, EN 300 440 class 2, FCC CFR47, Part 15 and ARIB STD-T-66		-62		dBm
Frequency error tolerance	Difference between center frequency of the received RF signal and local oscillator frequency		>200		ppm
RSSI dynamic range			100		dB
RSSI accuracy			± 4		dB

5.10 IEEE 802.15.4 (Offset Q-PSK DSSS, 250 kbps) – TX

RF performance is specified in a single ended 50-Ω reference plane at the antenna feeding point with $T_c = 25^\circ\text{C}$, $V_{DD} = 3.0\text{ V}$, unless otherwise noted.

PARAMETER	TEST CONDITIONS	MIN	TYP	MAX	UNIT
Output power, highest setting			5		dBm
Output power, lowest setting			-21		dBm
Error vector magnitude	At maximum output power		2%		
Spurious emission conducted measurement ⁽¹⁾	f < 1 GHz, outside restricted bands		-43		dBm
	f < 1 GHz, restricted bands ETSI		-58		
	f < 1 GHz, restricted bands FCC		-57		
	f > 1 GHz, including harmonics		-45		

(1) Suitable for systems targeting compliance with worldwide radio-frequency regulations ETSI EN 300 328 and EN 300 440 Class 2 (Europe), FCC CFR47 Part 15 (US), and ARIB STD-T66 (Japan)

5.11 24-MHz Crystal Oscillator (XOSC_HF)⁽¹⁾

over operating free-air temperature range (unless otherwise noted)

PARAMETER	TEST CONDITIONS	MIN	TYP	MAX	UNIT
Crystal frequency			24		MHz
Crystal frequency tolerance ⁽²⁾		-40		40	ppm
Start-up time ⁽³⁾			150		μs

(1) Probing or otherwise stopping the XTAL while the DC-DC converter is enabled may cause permanent damage to the device.

(2) Includes initial tolerance of the crystal, drift over temperature, aging and frequency pulling due to incorrect load capacitance. As per Bluetooth and IEEE 802.15.4 specification

(3) Kick-started based on a temperature and aging compensated RCOSC_HF using precharge injection

5.12 32.768-kHz Crystal Oscillator (XOSC_LF)

over operating free-air temperature range (unless otherwise noted)

PARAMETER	TEST CONDITIONS	MIN	TYP	MAX	UNIT
Crystal frequency			32.768		kHz
Initial crystal frequency tolerance, Bluetooth low energy applications	$T_c = 25^\circ\text{C}$	-20		20	ppm
Crystal aging		-3		3	ppm/year

5.13 48-MHz RC Oscillator (RCOSC_HF)

$T_c = 25^\circ\text{C}$, $V_{DD} = 3.0\text{ V}$, unless otherwise noted

PARAMETER	TEST CONDITIONS	MIN	TYP	MAX	UNIT
Frequency			48		MHz
Uncalibrated frequency accuracy			±1%		
Calibrated frequency accuracy ⁽¹⁾			±0.25%		
Start-up time			5		μs

(1) Accuracy relatively to the calibration source (XOSC_HF).

5.14 32-kHz RC Oscillator (RCOSC_LF)

$T_c = 25^\circ\text{C}$, $V_{DD} = 3.0\text{ V}$, unless otherwise noted

PARAMETER	TEST CONDITIONS	MIN	TYP	MAX	UNIT
Calibrated frequency			32.8		kHz
Temperature coefficient			50		ppm/°C

5.15 ADC Characteristics

$T_c = 25^\circ\text{C}$, $V_{DD} = 3.0\text{ V}$ and voltage scaling enabled, unless otherwise noted ⁽¹⁾

PARAMETER	TEST CONDITIONS	MIN	TYP	MAX	UNIT
Input voltage range		0		V_{DD}	V
Resolution			12		Bits
Sample rate				200	ksps
Offset	Internal 4.3-V equivalent reference ⁽²⁾		2		LSB
Gain error	Internal 4.3-V equivalent reference ⁽²⁾		2.4		LSB
DNL ⁽³⁾	Differential nonlinearity		>–1		LSB
INL ⁽⁴⁾	Integral nonlinearity		±3		LSB
ENOB	Effective number of bits	Internal 4.3-V equivalent reference ⁽²⁾ , 200 ksps, 9.6-kHz input tone		9.8	Bits
		VDD as reference, 200 ksps, 9.6-kHz input tone		10	
		Internal 1.44-V reference, voltage scaling disabled, 32 samples average, 200 ksps, 300-Hz input tone		11.1	
THD	Total harmonic distortion	Internal 4.3-V equivalent reference ⁽²⁾ , 200 ksps, 9.6-kHz input tone		–65	dB
		VDD as reference, 200 ksps, 9.6-kHz input tone		–69	
		Internal 1.44-V reference, voltage scaling disabled, 32 samples average, 200 ksps, 300-Hz input tone		–71	
SINAD and SNDR	Signal-to-noise and distortion ratio	Internal 4.3-V equivalent reference ⁽²⁾ , 200 ksps, 9.6-kHz input tone		60	dB
		VDD as reference, 200 ksps, 9.6-kHz input tone		63	
		Internal 1.44-V reference, voltage scaling disabled, 32 samples average, 200 ksps, 300-Hz input tone		69	
SFDR	Spurious-free dynamic range	Internal 4.3-V equivalent reference ⁽²⁾ , 200 ksps, 9.6-kHz input tone		67	dB
		VDD as reference, 200 ksps, 9.6-kHz input tone		72	
		Internal 1.44-V reference, voltage scaling disabled, 32 samples average, 200 ksps, 300-Hz input tone		73	
Conversion time	Serial conversion, time-to-output, 24-MHz clock		50		clock-cycles
Current consumption	Internal 4.3-V equivalent reference ⁽²⁾		0.66		mA
Current consumption	VDD as reference		0.75		mA
Reference voltage	Equivalent fixed internal reference (input voltage scaling enabled). For best accuracy, the ADC conversion should be initiated through the TI-RTOS™ API to include the gain or offset compensation factors stored in FCFG1.		4.3 ⁽²⁾⁽⁵⁾		V
Reference voltage	Fixed internal reference (input voltage scaling disabled). For best accuracy, the ADC conversion should be initiated through the TI-RTOS API to include the gain or offset compensation factors stored in FCFG1. This value is derived from the scaled value (4.3 V) as follows: $V_{ref} = 4.3\text{ V} \times 1408 / 4095$		1.48		V
Reference voltage	VDD as reference (Also known as <i>RELATIVE</i>) (input voltage scaling enabled)		VDD		V
Reference voltage	VDD as reference (Also known as <i>RELATIVE</i>) (input voltage scaling disabled)		$VDD / 2.82^{(5)}$		V
Input Impedance	200 ksps, voltage scaling enabled. Capacitive input, input impedance depends on sampling frequency and sampling time		>1		MΩ

(1) Using IEEE Std 1241™-2010 for terminology and test methods.

(2) Input signal scaled down internally before conversion, as if voltage range was 0 to 4.3 V.

(3) No missing codes. Positive DNL typically varies from +0.3 to +3.5 depending on device, see [Figure 5-24](#).

(4) For a typical example, see [Figure 5-25](#).

(5) Applied voltage must be within absolute maximum ratings (see [Section 5.1](#)) at all times.

5.16 Temperature Sensor

 $T_c = 25^\circ\text{C}$, $V_{DD} = 3.0\text{ V}$, unless otherwise noted

PARAMETER	TEST CONDITIONS	MIN	TYP	MAX	UNIT
Resolution			4		$^\circ\text{C}$
Range		-40		85	$^\circ\text{C}$
Accuracy			± 5		$^\circ\text{C}$
Supply voltage coefficient ⁽¹⁾			3.2		$^\circ\text{C}/\text{V}$

(1) Automatically compensated when using supplied driver libraries.

5.17 Battery Monitor

 $T_c = 25^\circ\text{C}$, $V_{DD} = 3.0\text{ V}$, unless otherwise noted

PARAMETER	TEST CONDITIONS	MIN	TYP	MAX	UNIT
Resolution			50		mV
Range		1.8		3.8	V
Accuracy			13		mV

5.18 Continuous Time Comparator

 $T_c = 25^\circ\text{C}$, $V_{DD} = 3.0\text{ V}$, unless otherwise noted

PARAMETER	TEST CONDITIONS	MIN	TYP	MAX	UNIT
Input voltage range		0		V_{DD}	V
External reference voltage		0		V_{DD}	V
Internal reference voltage	DCOUPPL as reference		1.27		V
Offset			3		mV
Hysteresis			<2		mV
Decision time	Step from -10 mV to +10 mV		0.72		μs
Current consumption when enabled ⁽¹⁾			8.6		μA

(1) Additionally, the bias module must be enabled when running in standby mode.

5.19 Low-Power Clocked Comparator

 $T_c = 25^\circ\text{C}$, $V_{DD} = 3.0\text{ V}$, unless otherwise noted

PARAMETER	TEST CONDITIONS	MIN	TYP	MAX	UNIT
Input voltage range		0		V_{DD}	V
Clock frequency			32		kHz
Internal reference voltage, $V_{DD} / 2$			1.49–1.51		V
Internal reference voltage, $V_{DD} / 3$			1.01–1.03		V
Internal reference voltage, $V_{DD} / 4$			0.78–0.79		V
Internal reference voltage, DCOUPL / 1			1.25–1.28		V
Internal reference voltage, DCOUPL / 2			0.63–0.65		V
Internal reference voltage, DCOUPL / 3			0.42–0.44		V
Internal reference voltage, DCOUPL / 4			0.33–0.34		V
Offset			<2		mV
Hysteresis			<5		mV
Decision time	Step from -50 mV to +50 mV		<1		clock-cycle
Current consumption when enabled			362		nA

5.20 Programmable Current Source

$T_c = 25^\circ\text{C}$, $V_{DD} = 3.0\text{ V}$, unless otherwise noted.

PARAMETER	TEST CONDITIONS	MIN	TYP	MAX	UNIT
Current source programmable output range			0.25–20		μA
Resolution			0.25		μA
Current consumption ⁽¹⁾	Including current source at maximum programmable output		23		μA

(1) Additionally, the bias module must be enabled when running in standby mode.

5.21 DC Characteristics

PARAMETER	TEST CONDITIONS	MIN	TYP	MAX	UNIT
$T_A = 25^\circ\text{C}$, $V_{DD} = 1.8\text{ V}$					
GPIO VOH at 8-mA load	IOCURR = 2, high-drive GPIOs only	1.32	1.54		V
GPIO VOL at 8-mA load	IOCURR = 2, high-drive GPIOs only		0.26	0.32	V
GPIO VOH at 4-mA load	IOCURR = 1	1.32	1.58		V
GPIO VOL at 4-mA load	IOCURR = 1		0.21	0.32	V
GPIO pullup current	Input mode, pullup enabled, $V_{pad} = 0\text{ V}$		71.7		μA
GPIO pulldown current	Input mode, pulldown enabled, $V_{pad} = V_{DD}$		21.1		μA
GPIO high/low input transition, no hysteresis	IH = 0, transition between reading 0 and reading 1		0.88		V
GPIO low-to-high input transition, with hysteresis	IH = 1, transition voltage for input read as 0 → 1		1.07		V
GPIO high-to-low input transition, with hysteresis	IH = 1, transition voltage for input read as 1 → 0		0.74		V
GPIO input hysteresis	IH = 1, difference between 0 → 1 and 1 → 0 points		0.33		V
$T_A = 25^\circ\text{C}$, $V_{DD} = 3.0\text{ V}$					
GPIO VOH at 8-mA load	IOCURR = 2, high-drive GPIOs only		2.68		V
GPIO VOL at 8-mA load	IOCURR = 2, high-drive GPIOs only		0.33		V
GPIO VOH at 4-mA load	IOCURR = 1		2.72		V
GPIO VOL at 4-mA load	IOCURR = 1		0.28		V
$T_A = 25^\circ\text{C}$, $V_{DD} = 3.8\text{ V}$					
GPIO pullup current	Input mode, pullup enabled, $V_{pad} = 0\text{ V}$		277		μA
GPIO pulldown current	Input mode, pulldown enabled, $V_{pad} = V_{DD}$		113		μA
GPIO high/low input transition, no hysteresis	IH = 0, transition between reading 0 and reading 1		1.67		V
GPIO low-to-high input transition, with hysteresis	IH = 1, transition voltage for input read as 0 → 1		1.94		V
GPIO high-to-low input transition, with hysteresis	IH = 1, transition voltage for input read as 1 → 0		1.54		V
GPIO input hysteresis	IH = 1, difference between 0 → 1 and 1 → 0 points		0.4		V
$T_A = 25^\circ\text{C}$					
VIH	Lowest GPIO input voltage reliably interpreted as a «High»			0.8	VDD
VIL	Highest GPIO input voltage reliably interpreted as a «Low»	0.2			VDD

5.22 Thermal Resistance Characteristics for MOH Package

NAME	DESCRIPTION	°C/W ^{(1) (2)}	AIR FLOW (m/s) ⁽³⁾
R _{θJC}	Junction-to-case	20.0	
R _{θJB}	Junction-to-board	15.3	
R _{θJA}	Junction-to-free air	29.6	0
R _{θJMA}	Junction-to-moving air	25.0	1
Psi _{JT}	Junction-to-package top	8.8	0
Psi _{JB}	Junction-to-board	14.8	0

(1) °C/W = degrees Celsius per watt.

(2) These values are based on a JEDEC-defined 2S2P system (with the exception of the Theta JC [R_{θJC}] value, which is based on a JEDEC-defined 1S0P system) and will change based on environment as well as application. For more information, see these EIA/JEDEC standards:

- JESD51-2, *Integrated Circuits Thermal Test Method Environmental Conditions - Natural Convection (Still Air)*
- JESD51-3, *Low Effective Thermal Conductivity Test Board for Leaded Surface Mount Packages*
- JESD51-7, *High Effective Thermal Conductivity Test Board for Leaded Surface Mount Packages*
- JESD51-9, *Test Boards for Area Array Surface Mount Package Thermal Measurements*

Power dissipation of 2 W and an ambient temperature of 70°C is assumed.

(3) m/s = meters per second.

5.23 Timing Requirements

		MIN	NOM	MAX	UNIT
Rising supply-voltage slew rate		0		100	mV/μs
Falling supply-voltage slew rate		0		20	mV/μs
Falling supply-voltage slew rate, with low-power flash settings ⁽¹⁾				3	mV/μs
Positive temperature gradient in standby ⁽²⁾		No limitation for negative temperature gradient, or outside standby mode			5 °C/s
CONTROL INPUT AC CHARACTERISTICS⁽³⁾					
RESET_N low duration		1			μs
SYNCHRONOUS SERIAL INTERFACE (SSI)⁽⁴⁾					
S1 (SLAVE) ⁽⁵⁾	t _{clk_per}	12		65024	System clocks
S2 ⁽⁵⁾	t _{clk_high}		0.5		t _{clk_per}
S3 ⁽⁵⁾	t _{clk_low}		0.5		t _{clk_per}

(1) For smaller coin cell batteries, with high worst-case end-of-life equivalent source resistance, a 22-μF VDD input capacitor (see [Section 7.1.1](#)) must be used to ensure compliance with this slew rate.

(2) Applications using RCOSC_LF as sleep timer must also consider the drift in frequency caused by a change in temperature (see [Section 5.14](#)).

(3) T_A = -40°C to +85°C, V_{DD} = 1.7 V to 3.8 V, unless otherwise noted.

(4) T_c = 25°C, V_{DD} = 3.0 V, unless otherwise noted. Device operating as slave. For SSI master operation, see [Section 5.24](#).

(5) Refer to the SSI timing diagrams [Figure 5-1](#), [Figure 5-2](#), and [Figure 5-3](#).

5.24 Switching Characteristics

Measured on the TI CC2650EM-5XD reference design with T_c = 25°C, V_{DD} = 3.0 V, unless otherwise noted.

PARAMETER	TEST CONDITIONS	MIN	TYP	MAX	UNIT
WAKEUP AND TIMING					
Idle → Active			14		μs
Standby → Active			151		μs
Shutdown → Active			1015		μs

Switching Characteristics (continued)

Measured on the TI CC2650EM-5XD reference design with $T_c = 25^\circ\text{C}$, $V_{DD} = 3.0\text{ V}$, unless otherwise noted.

PARAMETER	TEST CONDITIONS	MIN	TYP	MAX	UNIT
SYNCHRONOUS SERIAL INTERFACE (SSI) ⁽¹⁾					
S1 (TX only) ⁽²⁾ $t_{\text{clk_per}}$ (SSIClk period)	One-way communication to SLAVE	4		65024	System clocks
S1 (TX and RX) ⁽²⁾ $t_{\text{clk_per}}$ (SSIClk period)	Normal duplex operation	8		65024	System clocks
S2 ⁽²⁾ $t_{\text{clk_high}}$ (SSIClk high time)			0.5		$t_{\text{clk_per}}$
S3 ⁽²⁾ $t_{\text{clk_low}}$ (SSIClk low time)			0.5		$t_{\text{clk_per}}$

- (1) Device operating as master. For SSI slave operation, see [Section 5.23](#).
- (2) Refer to SSI timing diagrams [Figure 5-1](#), [Figure 5-2](#), and [Figure 5-3](#).

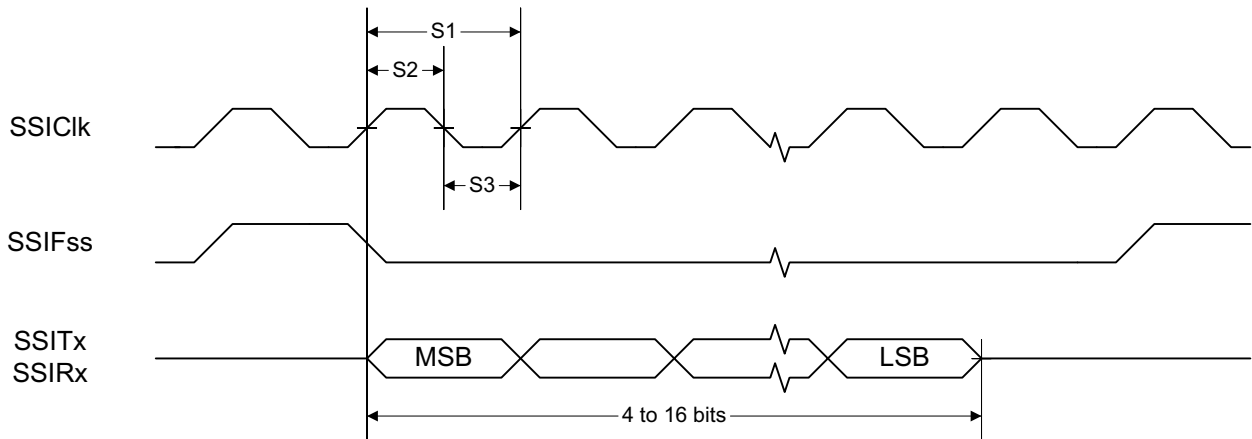

Figure 5-1. SSI Timing for TI Frame Format (FRF = 01), Single Transfer Timing Measurement

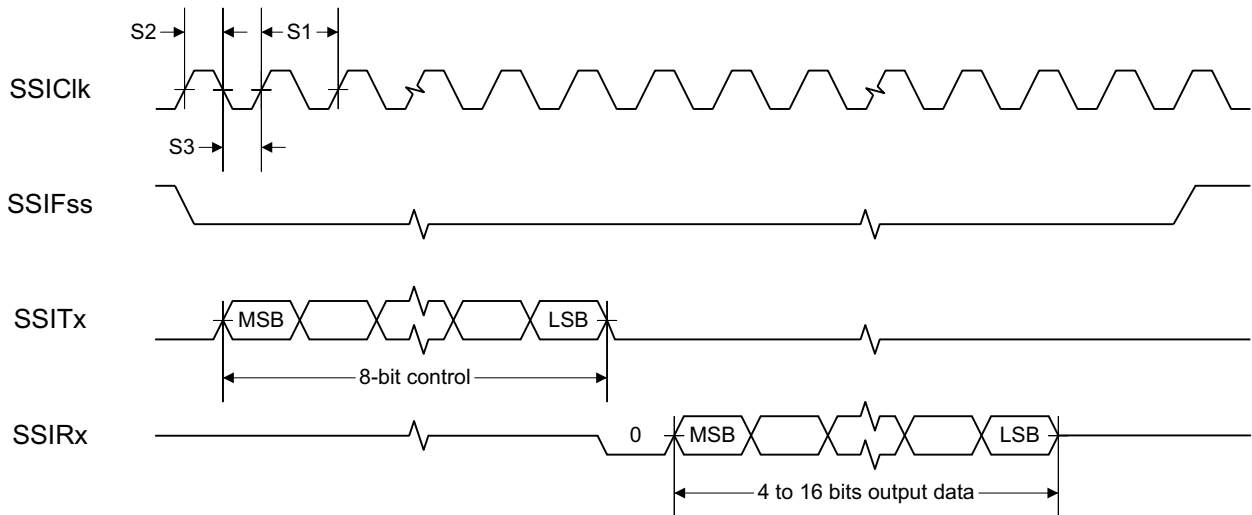

Figure 5-2. SSI Timing for MICROWIRE Frame Format (FRF = 10), Single Transfer

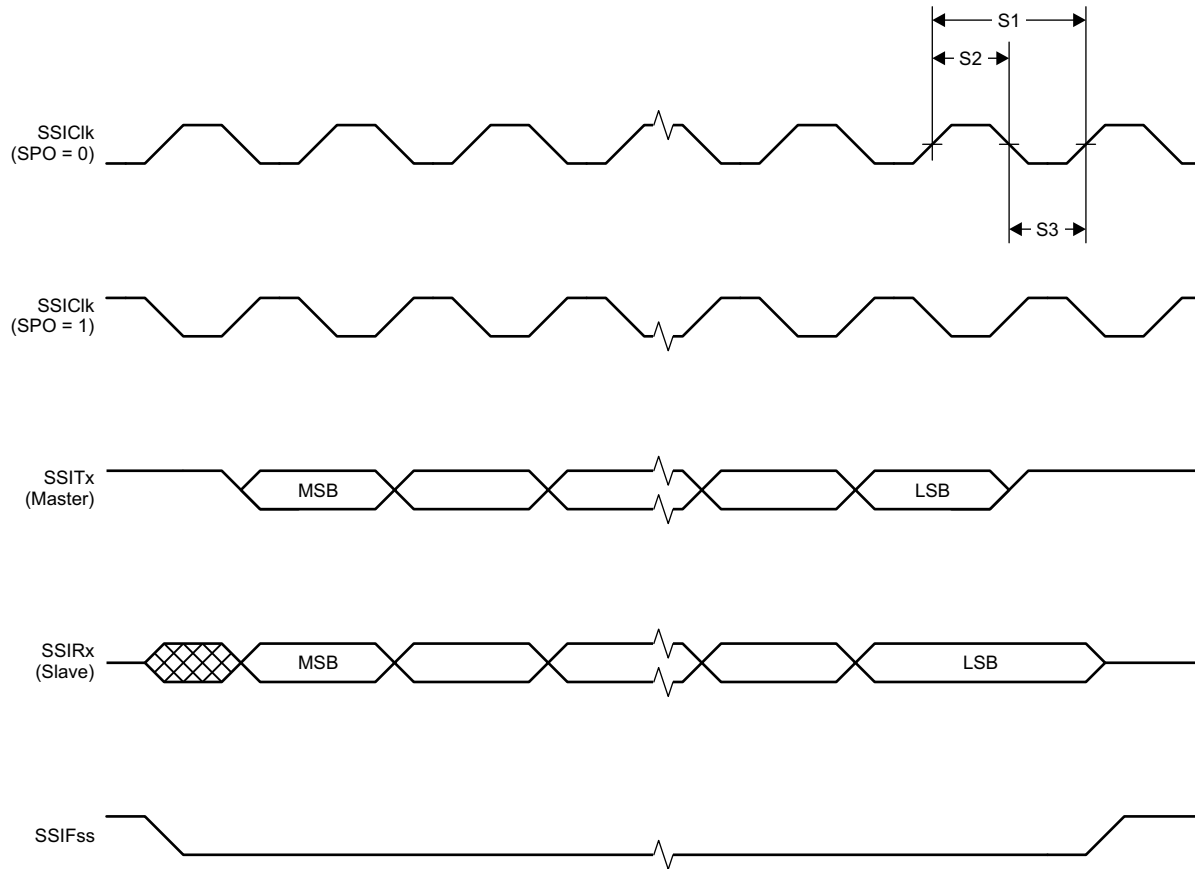

Figure 5-3. SSI Timing for SPI Frame Format (FRF = 00), With SPH = 1

5.25 Typical Characteristics

This section contains typical performance plots measured on the CC2650F128RHB device. They are published in the CC2650 data sheet, and the plots relevant for the CC2650MODA device are repeated here. RF performance is specified in a single-ended 50-Ω reference plane at the antenna feeding point with $T_c = 25^\circ\text{C}$ and $V_{DD} = 3.0\text{ V}$, unless otherwise noted.

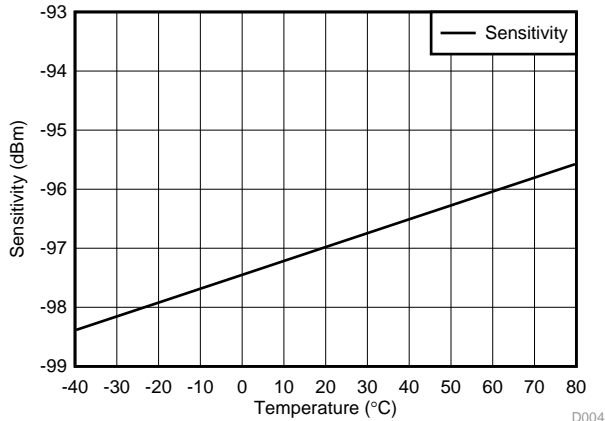

Figure 5-4. Bluetooth low energy Sensitivity vs Temperature D004

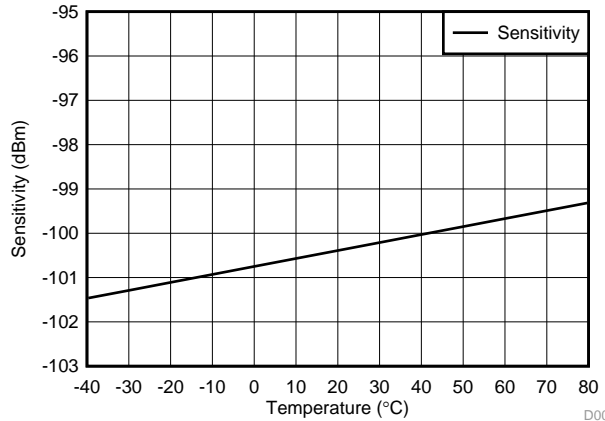

Figure 5-5. IEEE 802.15.4 Sensitivity vs Temperature D005

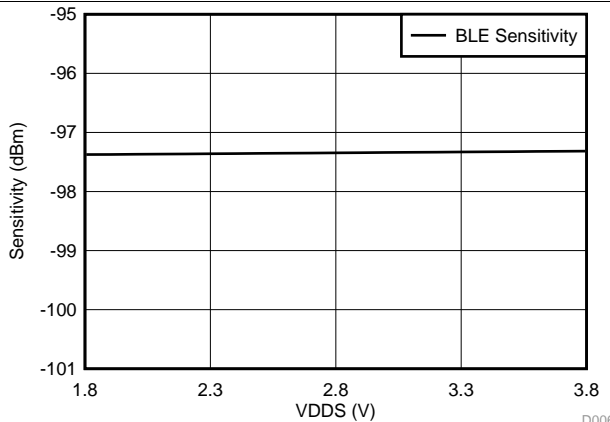

Figure 5-6. Bluetooth low energy Sensitivity vs Supply Voltage (VDD) D006

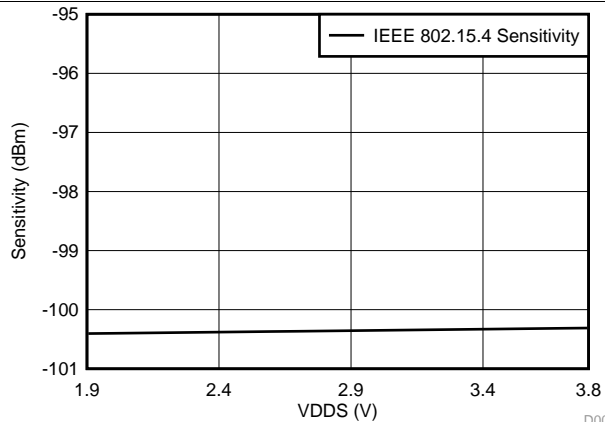

Figure 5-7. IEEE 802.15.4 Sensitivity vs Supply Voltage (VDD) D007

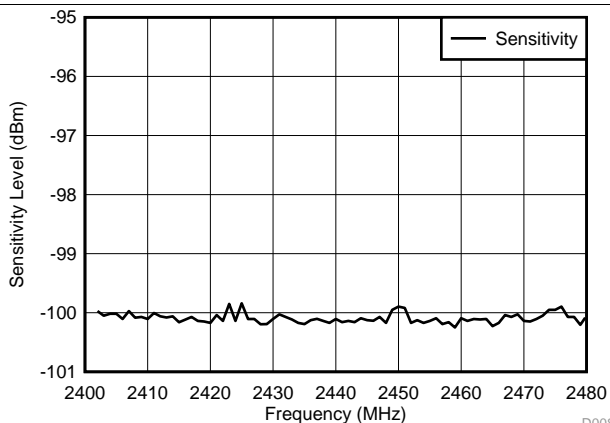

Figure 5-8. IEEE 802.15.4 Sensitivity vs Channel Frequency D008

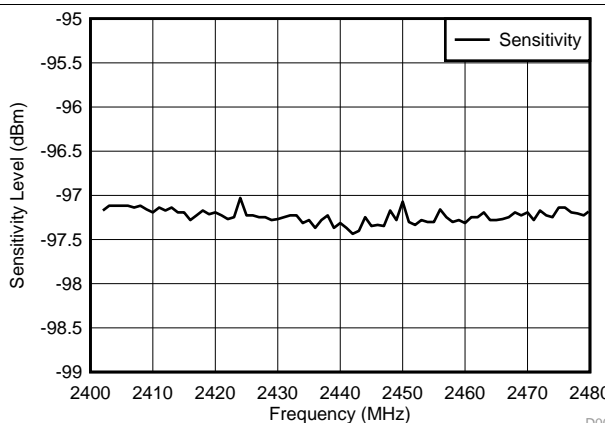
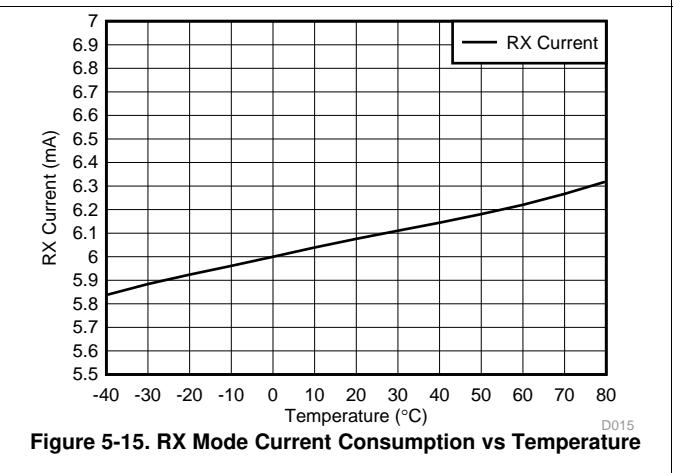
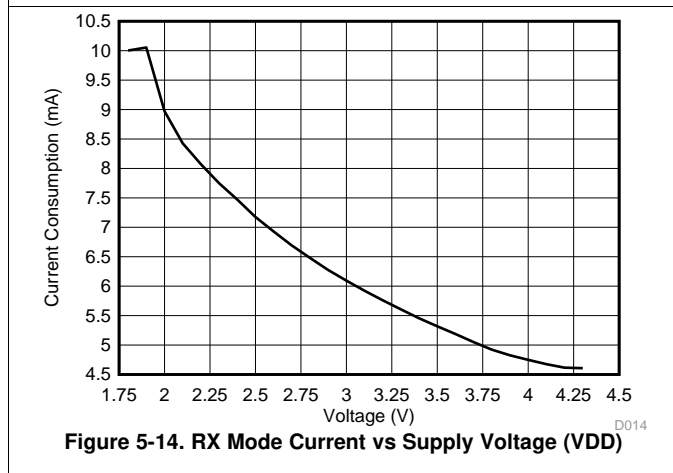
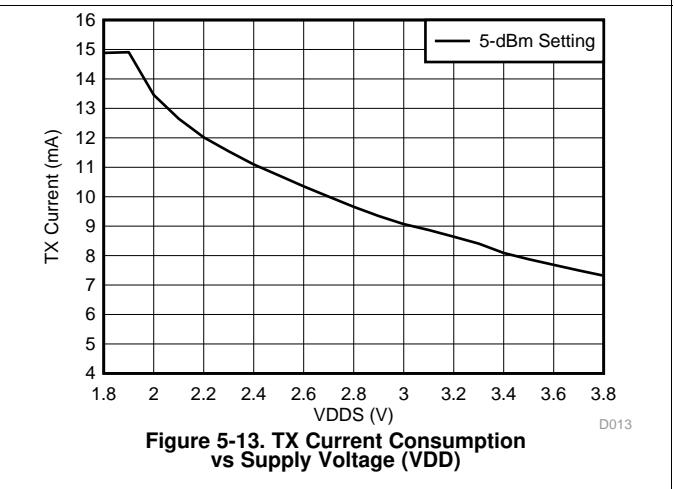
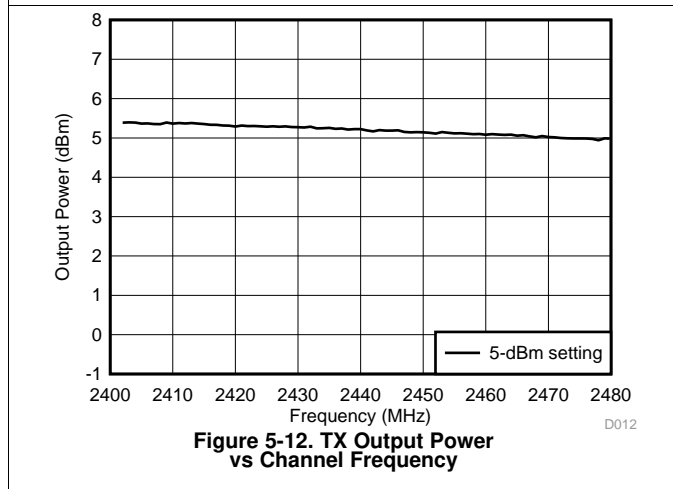
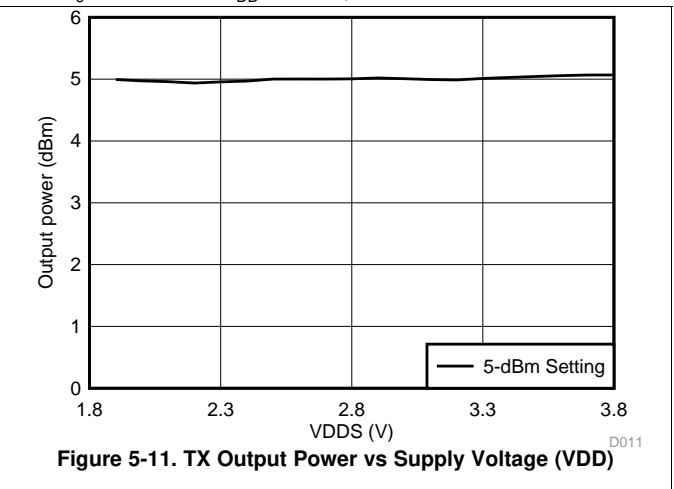
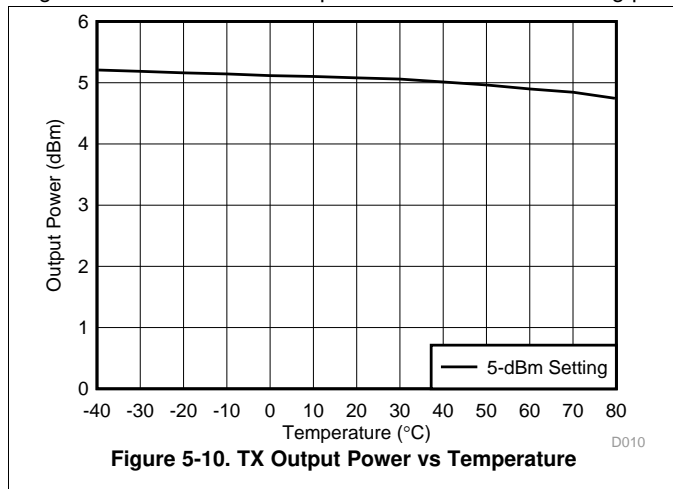

Figure 5-9. Bluetooth low energy Sensitivity vs Channel Frequency D009

Typical Characteristics (continued)

This section contains typical performance plots measured on the CC2650F128RHB device. They are published in the CC2650 data sheet, and the plots relevant for the CC2650MODA device are repeated here. RF performance is specified in a single-ended 50-Ω reference plane at the antenna feeding point with $T_c = 25^\circ\text{C}$ and $V_{DD} = 3.0\text{ V}$, unless otherwise noted.



Typical Characteristics (continued)

This section contains typical performance plots measured on the CC2650F128RHB device. They are published in the CC2650 data sheet, and the plots relevant for the CC2650MODA device are repeated here. RF performance is specified in a single-ended 50-Ω reference plane at the antenna feeding point with $T_c = 25^\circ\text{C}$ and $V_{DD} = 3.0\text{ V}$, unless otherwise noted.

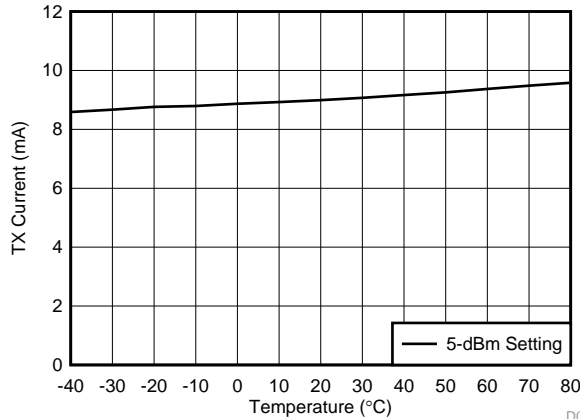

Figure 5-16. TX Mode Current Consumption vs Temperature D016

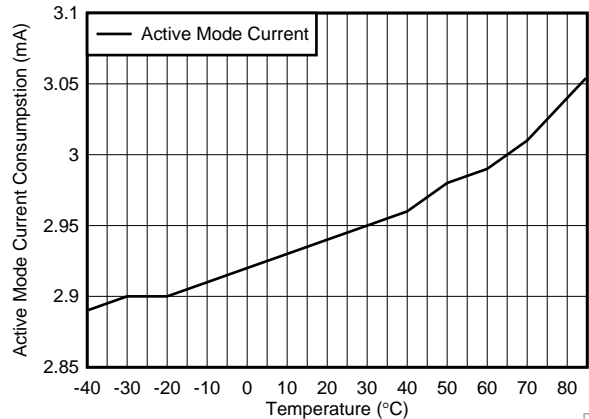

Figure 5-17. Active Mode (MCU Running, No Peripherals) Current Consumption vs Temperature D006

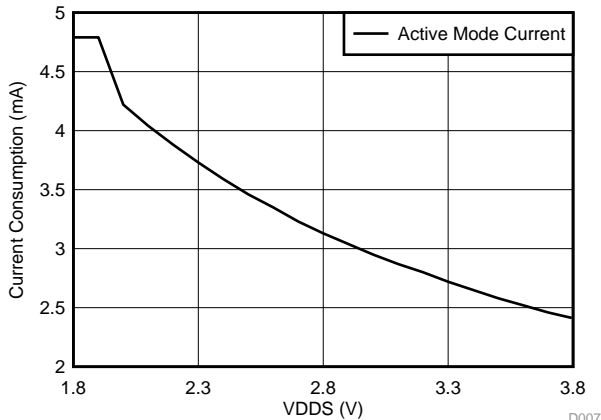

Figure 5-18. Active Mode (MCU Running, No Peripherals) Current Consumption vs Supply Voltage (VDD) D007

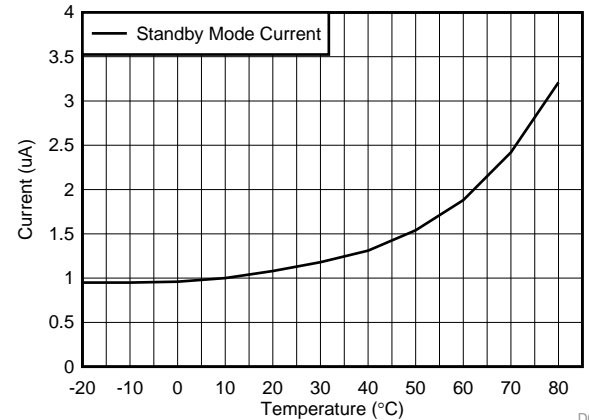

Figure 5-19. Standby Mode Current Consumption With RCOSC RTC vs Temperature D008

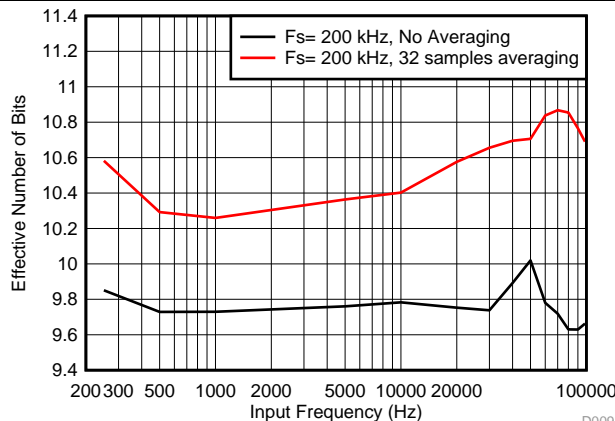

Figure 5-20. SoC ADC Effective Number of Bits vs Input Frequency (Internal Reference) D009

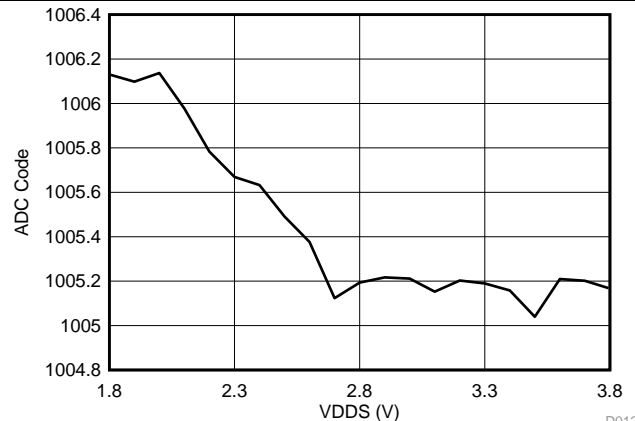
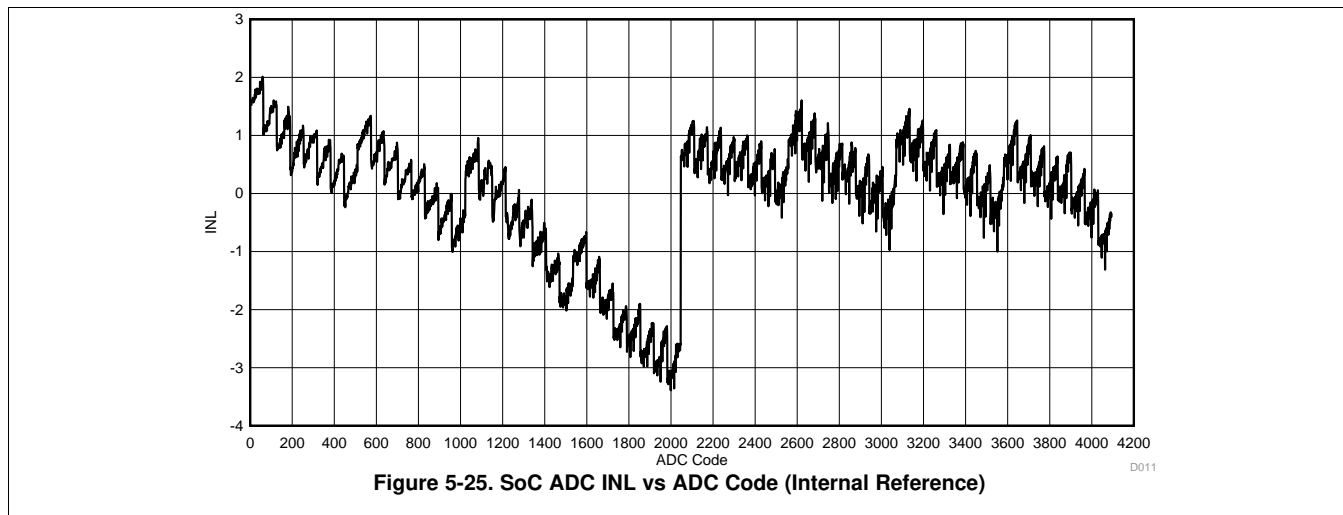
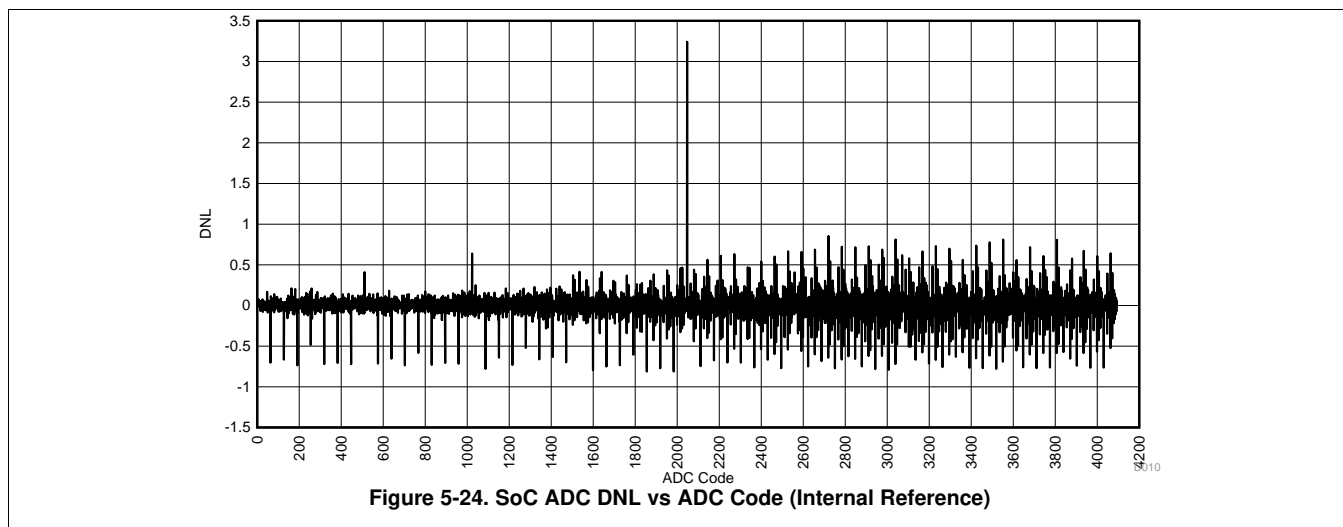
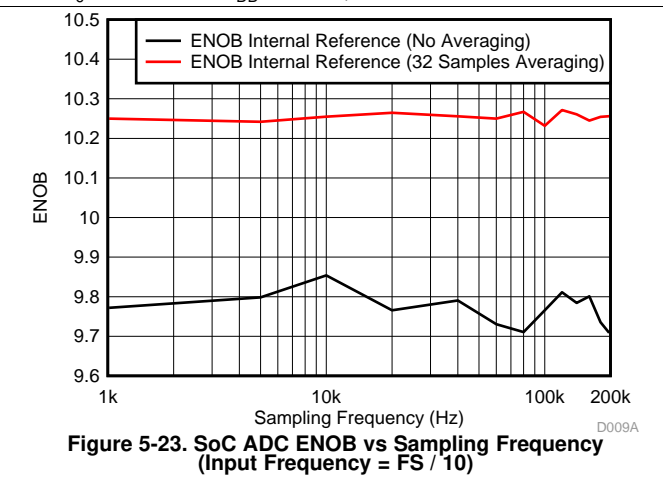
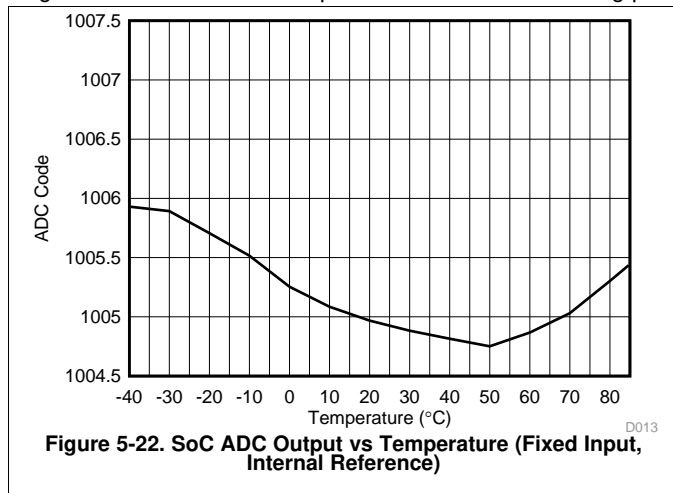

Figure 5-21. SoC ADC Output vs Supply Voltage (Fixed Input, Internal Reference) D012

Typical Characteristics (continued)

This section contains typical performance plots measured on the CC2650F128RHB device. They are published in the CC2650 data sheet, and the plots relevant for the CC2650MODA device are repeated here. RF performance is specified in a single-ended 50-Ω reference plane at the antenna feeding point with $T_c = 25^\circ\text{C}$ and $V_{DD} = 3.0\text{ V}$, unless otherwise noted.



6 Detailed Description

6.1 Overview

Figure 6-1 shows the core modules of the CC2650MODA device.

6.2 Functional Block Diagram

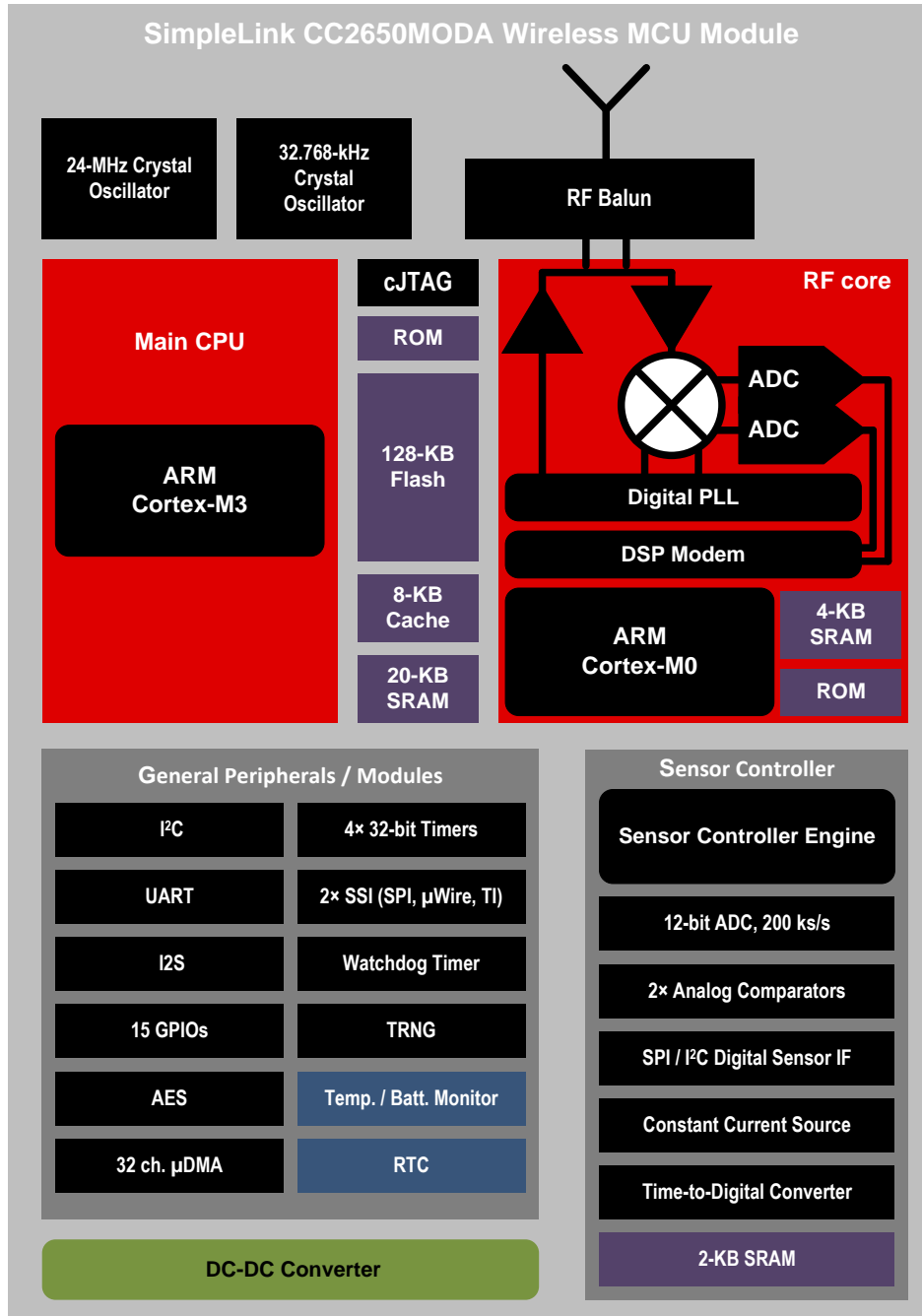

Copyright © 2017, Texas Instruments Incorporated

Figure 6-1. CC2650MODA Functional Block Diagram

6.3 Main CPU

The SimpleLink CC2650MODA wireless MCU contains an ARM Cortex-M3 32-bit CPU, which runs the application and the higher layers of the protocol stack.

The Cortex-M3 processor provides a high-performance, low-cost platform that meets the system requirements of minimal memory implementation, and low-power consumption, while delivering outstanding computational performance and exceptional system response to interrupts.

Cortex-M3 features include:

- 32-bit ARM Cortex-M3 architecture optimized for small-footprint embedded applications
- Outstanding processing performance combined with fast interrupt handling
- ARM Thumb[®]-2 mixed 16- and 32-bit instruction set delivers the high performance expected of a 32-bit ARM core in a compact memory size usually associated with 8- and 16-bit devices, typically in the range of a few kilobytes of memory for microcontroller-class applications:
 - Single-cycle multiply instruction and hardware divide
 - Atomic bit manipulation (bit-banding), delivering maximum memory use and streamlined peripheral control
 - Unaligned data access, enabling data to be efficiently packed into memory
- Fast code execution permits slower processor clock or increases sleep mode time
- Harvard architecture characterized by separate buses for instruction and data
- Efficient processor core, system, and memories
- Hardware division and fast digital-signal-processing oriented multiply accumulate
- Saturating arithmetic for signal processing
- Deterministic, high-performance interrupt handling for time-critical applications
- Enhanced system debug with extensive breakpoint and trace capabilities
- Serial wire trace reduces the number of pins required for debugging and tracing
- Migration from the ARM7[™] processor family for better performance and power efficiency
- Optimized for single-cycle flash memory use
- Ultra-low-power consumption with integrated sleep modes
- 1.25 DMIPS per MHz

6.4 RF Core

The RF core contains an ARM Cortex-M0 processor that interfaces the analog RF and base-band circuitries, handles data to and from the system side, and assembles the information bits in a given packet structure. The RF core offers a high-level, command-based API to the main CPU.

The RF core can autonomously handle the time-critical aspects of the radio protocols (802.15.4 RF4CE and ZigBee, Bluetooth low energy) thus offloading the main CPU and leaving more resources for the user application.

The RF core has a dedicated 4-KB SRAM block and runs initially from separate ROM memory. The ARM Cortex-M0 processor is not programmable by customers.

6.5 Sensor Controller

The Sensor Controller contains circuitry that can be selectively enabled in standby mode. The peripherals in this domain may be controlled by the Sensor Controller Engine, which is a proprietary power-optimized CPU. This CPU can read and monitor sensors or perform other tasks autonomously, thereby significantly reducing power consumption and offloading the main Cortex-M3 CPU.

The Sensor Controller is set up using a PC-based configuration tool, called Sensor Controller Studio, and typical use cases may be (but are not limited to):

- Analog sensors using integrated ADC
- Digital sensors using GPIOs and bit-banged I²C or SPI
- UART communication for sensor reading or debugging
- Capacitive sensing
- Waveform generation
- Pulse counting
- Keyboard scan
- Quadrature decoder for polling rotation sensors
- Oscillator calibration

The peripherals in the Sensor Controller include the following:

- The low-power clocked comparator can be used to wake the device from any state in which the comparator is active. A configurable internal reference can be used with the comparator. The output of the comparator can also be used to trigger an interrupt or the ADC.
- Capacitive sensing functionality is implemented through the use of a constant current source, a time-to-digital converter, and a comparator. The continuous time comparator in this block can also be used as a higher-accuracy alternative to the low-power clocked comparator. The Sensor Controller will take care of baseline tracking, hysteresis, filtering and other related functions.
- The ADC is a 12-bit, 200-ksamples/s ADC with eight inputs and a built-in voltage reference. The ADC can be triggered by many different sources, including timers, I/O pins, software, the analog comparator, and the RTC.
- The Sensor Controller also includes a SPI/I²C digital interface.
- The analog modules can be connected to up to eight different GPIOs.

The peripherals in the Sensor Controller can also be controlled from the main application processor.

Table 6-1 lists the GPIOs that are connected to the Sensor Controller.

Table 6-1. GPIOs Connected to the Sensor Controller⁽¹⁾

ANALOG CAPABLE	16.9 × 11 MOH DIO NUMBER
Y	14
Y	13
Y	12
Y	11
Y	9
Y	10
Y	8
Y	7
N	4
N	3
N	2
N	1
N	0

(1) Up to 13 pins can be connected to the Sensor Controller. Up to eight of these pins can be connected to analog modules

6.6 Memory

The flash memory provides nonvolatile storage for code and data. The flash memory is in-system programmable.

The SRAM (static RAM) can be used for both storage of data and execution of code and is split into two 4-KB blocks and two 6-KB blocks. Retention of the RAM contents in standby mode can be enabled or disabled individually for each block to minimize power consumption. In addition, if flash cache is disabled, the 8KB of cache can be used as a general-purpose RAM.

The ROM provides preprogrammed embedded TI-RTOS kernel, Driverlib and lower layer protocol stack software (802.15.4 MAC and Bluetooth low energy Controller). The ROM also contains a bootloader that can be used to reprogram the device using SPI or UART.

6.7 Debug

The on-chip debug support is done through a dedicated cJTAG (IEEE 1149.7) or JTAG (IEEE 1149.1) interface.

6.8 Power Management

To minimize power consumption, the CC2650MODA device supports a number of power modes and power-management features (see [Table 6-2](#)).

Table 6-2. Power Modes

MODE	SOFTWARE-CONFIGURABLE POWER MODES				RESET PIN HELD
	ACTIVE	IDLE	STANDBY	SHUTDOWN	
CPU	Active	Off	Off	Off	Off
Flash	On	Available	Off	Off	Off
SRAM	On	On	On	Off	Off
Radio	Available	Available	Off	Off	Off
Supply System	On	On	Duty Cycled	Off	Off
Current	1.45 mA + 31 µA/MHz	550 µA	1 µA	0.15 µA	0.1 µA
Wake-up time to CPU active ⁽¹⁾	–	14 µs	151 µs	1015 µs	1015 µs
Register retention	Full	Full	Partial	No	No
SRAM retention	Full	Full	Full	No	No
High-speed clock	XOSC_HF or RCOSC_HF	XOSC_HF or RCOSC_HF	Off	Off	Off
Low-speed clock	XOSC_LF or RCOSC_LF	XOSC_LF or RCOSC_LF	XOSC_LF or RCOSC_LF	Off	Off
Peripherals	Available	Available	Off	Off	Off
Sensor Controller	Available	Available	Available	Off	Off
Wake up on RTC	Available	Available	Available	Off	Off
Wake up on pin edge	Available	Available	Available	Available	Off
Wake up on reset pin	Available	Available	Available	Available	Available
Brown Out Detector (BOD)	Active	Active	Duty Cycled ⁽²⁾	Off	N/A
Power On Reset (POR)	Active	Active	Active	Active	N/A

(1) Not including RTOS overhead

(2) The Brown Out Detector is disabled between recharge periods in STANDBY. Lowering the supply voltage below the BOD threshold between two recharge periods while in STANDBY may cause the BOD to lock the device upon wake-up until a Reset or POR releases it. To avoid this, TI recommends that STANDBY mode is avoided if there is a risk that the supply voltage (VDD) may drop below the specified operating voltage range. For the same reason, it is also good practice to ensure that a power cycling operation, such as a battery replacement, triggers a Power-on-reset by ensuring that the VDD decoupling network is fully depleted before applying supply voltage again (for example, inserting new batteries).

In active mode, the application Cortex-M3 CPU is actively executing code. Active mode provides normal operation of the processor and all of the peripherals that are currently enabled. The system clock can be any available clock source (see [Table 6-2](#)).

In idle mode, all active peripherals can be clocked, but the Application CPU core and memory are not clocked and no code is executed. Any interrupt event will bring the processor back into active mode.

In standby mode, only the always-on domain (AON) is active. An external wake event, RTC event, or sensor-controller event is required to bring the device back to active mode. MCU peripherals with retention do not need to be reconfigured when waking up again, and the CPU continues execution from where it went into standby mode. All GPIOs are latched in standby mode.

In shutdown mode, the device is turned off entirely, including the AON domain and the Sensor Controller. The I/Os are latched with the value they had before entering shutdown mode. A change of state on any I/O pin, defined as a *wake from Shutdown pin*, wakes up the device and functions as a reset trigger. The CPU can differentiate between a reset in this way, a reset-by-reset pin, or a power-on-reset by reading the reset status register. The only state retained in this mode is the latched I/O state and the flash memory contents.

The Sensor Controller is an autonomous processor that can control the peripherals in the Sensor Controller independently of the main CPU, which means that the main CPU does not have to wake up, for example, to execute an ADC sample or poll a digital sensor over SPI. The main CPU saves both current and wake-up time that would otherwise be wasted. The Sensor Controller Studio enables the user to configure the sensor controller and choose which peripherals are controlled and which conditions wake up the main CPU.

6.9 Clock Systems

The CC2650MODA device supports two external and two internal clock sources.

A 24-MHz crystal is required as the frequency reference for the radio. This signal is doubled internally to create a 48-MHz clock.

The 32-kHz crystal is optional. Bluetooth low energy requires a slow-speed clock with better than ± 500 -ppm accuracy if the device is to enter any sleep mode while maintaining a connection. The internal 32-kHz RC oscillator can in some use cases be compensated to meet the requirements. The low-speed crystal oscillator is designed for use with a 32-kHz watch-type crystal.

The internal high-speed oscillator (48 MHz) can be used as a clock source for the CPU subsystem.

The internal low-speed oscillator (32.768 kHz) can be used as a reference if the low-power crystal oscillator is not used.

The 32-kHz clock source can be used as external clocking reference through GPIO.

6.10 General Peripherals and Modules

The I/O controller controls the digital I/O pins and contains multiplexer circuitry to allow a set of peripherals to be assigned to I/O pins in a flexible manner. All digital I/Os are interrupt and wake-up capable, have a programmable pullup and pulldown function and can generate an interrupt on a negative or positive edge (configurable). When configured as an output, pins can function as either push-pull or open-drain. Five GPIOs have high-drive capabilities (marked in **bold** in [Section 4](#)).

The SSIs are synchronous serial interfaces that are compatible with SPI, MICROWIRE, and TI's synchronous serial interfaces. The SSIs support both SPI master and slave up to 4 MHz.

The UART implements a universal asynchronous receiver/transmitter function. It supports flexible baud-rate generation up to a maximum of 3 Mbps.

Timer 0 is a general-purpose timer module (GPTM), which provides two 16-bit timers. The GPTM can be configured to operate as a single 32-bit timer, dual 16-bit timers or as a PWM module.

Timer 1, Timer 2, and Timer 3 are also GPTMs. Each of these timers is functionally equivalent to Timer 0.

In addition to these four timers, the RF core has its own timer to handle timing for RF protocols; the RF timer can be synchronized to the RTC.

The I²C interface is used to communicate with devices compatible with the I²C standard. The I²C interface is capable of 100-kHz and 400-kHz operation, and can serve as both I²C master and I²C slave.

The TRNG module provides a true, nondeterministic noise source for the purpose of generating keys, initialization vectors (IVs), and other random number requirements. The TRNG is built on 24 ring oscillators that create unpredictable output to feed a complex nonlinear combinatorial circuit.

The watchdog timer is used to regain control if the system fails due to a software error after an external device fails to respond as expected. The watchdog timer can generate an interrupt or a reset when a predefined time-out value is reached.

The device includes a direct memory access (μ DMA) controller. The μ DMA controller provides a way to offload data transfer tasks from the Cortex-M3 CPU, allowing for more efficient use of the processor and the available bus bandwidth. The μ DMA controller can perform transfer between memory and peripherals. The μ DMA controller has dedicated channels for each supported on-chip module and can be programmed to automatically perform transfers between peripherals and memory as the peripheral is ready to transfer more data. Some features of the μ DMA controller include the following (this is not an exhaustive list):

- Highly flexible and configurable channel operation of up to 32 channels
- Transfer modes: memory-to-memory, memory-to-peripheral, peripheral-to-memory, and peripheral-to-peripheral
- Data sizes of 8, 16, and 32 bits

The AON domain contains circuitry that is always enabled, except in Shutdown mode (where the digital supply is off). This circuitry includes the following:

- The RTC can be used to wake the device from any state where it is active. The RTC contains three compare and one capture registers. With software support, the RTC can be used for clock and calendar operation. The RTC is clocked from the 32-kHz RC oscillator or crystal. The RTC can also be compensated to tick at the correct frequency even when the internal 32-kHz RC oscillator is used instead of a crystal.
- The battery monitor and temperature sensor are accessible by software and give a battery status indication as well as a coarse temperature measure.

6.11 System Architecture

Depending on the product configuration, CC26xx can function either as a Wireless Network Processor (WNP—an IC running the wireless protocol stack, with the application running on a separate MCU), or as a System-on-Chip (SoC), with the application and protocol stack running on the ARM Cortex-M3 core inside the device.

In the first case, the external host MCU communicates with the device using SPI or UART. In the second case, the application must be written according to the application framework supplied with the wireless protocol stack.

6.12 Certification

The CC2650MODA module is certified to the standards listed in [Table 6-3](#) (with IDs where applicable).

Table 6-3. CC2650MODA List of Certifications

REGULATORY BODY	SPECIFICATION	ID (IF APPLICABLE)
FCC (USA)	Part 15C:2015 + MPE FCC 1.1307 RF Exposure (Bluetooth)	FCC ID: ZAT26M1
	Part 15C:2015 + MPE FCC 1.1307 RF Exposure (802.15.4)	
IC (Canada)	RSS-102 (MPE) and RSS-247 (Bluetooth)	ID: 451H-26M1
	RSS-102 (MPE) and RSS-247 (IEEE 802.15.4)	
ETSI/CE (Europe)	EN 300 328 V2.1.1 (Bluetooth)	
	EN 300 328 V2.1.1 (802.15.4)	
	EN 62479:2010 (MPE)	
	Draft EN 301 489-1 V2.2.0 (2017-03)	
	Draft EN 301 489-1 V3.2.0 (2017-03)	
	EN 55024:2010 + A1:2015	
	EN 55032:2015 + AC:2016-07	
	EN 60950-1:2006/A11:2009/A1:2010/A12:2011/A2:2013	
Japan MIC	ARIB STD-T66	No: 201-160413/00
	JATE	D 16 0093 201/00

6.12.1 Regulatory Information Europe

Hereby, Texas Instruments Inc. declares that the radio equipment type CC2650MODA is in compliance with Directive 2014/53/EU.

The full text of the EU Declaration of Conformity (DoC) is available on the [CC2650MODA technical documents page](#). The compliance has been verified in the operating frequency band of 2400 MHz to 2483.5 MHz. Developers and integrators that incorporate the CC2650MODA RF Module in any end products are responsible for obtaining applicable regulatory approvals for such end product.

NOTE

The CC2650MODA has been tested in the 2400-GHz to 2483.5-GHz ISM frequency band at 3.3 V with a maximum peak power of 5.056-dBm EIRP across the temperature range –40°C to +85°C and tolerance.

6.12.2 Federal Communications Commission Statement

You are cautioned that changes or modifications not expressly approved by the part responsible for compliance could void the user's authority to operate the equipment.

This device complies with Part 15 of the FCC Rules. Operation is subject to the following two conditions:

1. This device may not cause harmful interference and
2. This device must accept any interference received, including interference that may cause undesired operation of the device.

FCC RF Radiation Exposure Statement:

This equipment complies with FCC radiation exposure limits set forth for an uncontrolled environment. End users must follow the specific operating instructions for satisfying RF exposure limits. This transmitter must not be colocated or operating with any other antenna or transmitter.

6.12.3 Canada, Industry Canada (IC)

This device complies with Industry Canada licence-exempt RSS standards.

Operation is subject to the following two conditions:

1. This device may not cause interference, and
2. This device must accept any interference, including interference that may cause undesired operation of the device

Le présent appareil est conforme aux CNR d'Industrie Canada applicables aux appareils radio exempts de licence

L'exploitation est autorisée aux deux conditions suivantes:

1. l'appareil ne doit pas produire de brouillage, et
2. l'utilisateur de l'appareil doit accepter tout brouillage radioélectrique subi, même si le brouillage est susceptible d'en compromettre le fonctionnement.

IC RF Radiation Exposure Statement:

To comply with IC RF exposure requirements, this device and its antenna must not be co-located or operating in conjunction with any other antenna or transmitter.

Pour se conformer aux exigences de conformité RF canadienne l'exposition, cet appareil et son antenne ne doivent pas être co-localisés ou fonctionnant en conjonction avec une autre antenne ou transmetteur.

6.12.4 Japan (JATE ID)

JATE ID is D 16 0093 201

For units already sold and marked with JATE ID: D 16 0086 201, please publicize to users that the JATE ID: D 16 0086 201 should be read as D 16 0093 201 (for example, clients web page, by software update, or similar).

6.13 End Product Labeling

This module is designed to comply with the FCC statement, FCC ID: ZAT26M1. The host system using this module must display a visible label indicating the following text:

"Contains FCC ID: ZAT26M1"

This module is designed to comply with the IC statement, IC: 451H-26M1. The host system using this module must display a visible label indicating the following text:

"Contains IC: 451H-26M1"

6.14 Manual Information to the End User

The OEM integrator must be aware not to provide information to the end user regarding how to install or remove this RF module in the user's manual of the end product that integrates this module.

NOTE

Operation outside of test conditions as documented in this datasheet is not supported and may void TI's warranty. Should the user choose to configure the CC2650MODA to operate outside of the test conditions, the device must be operated inside a protected and controlled environment, such as an RF shielded chamber and user must ensure compliance with regulatory requirements.

The end user's manual must include all required regulatory information and warnings as shown in this document.



6.15 Module Marking

Figure 6-2 shows the marking for the SimpleLink™ CC2650MODA module.

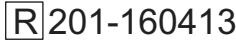

Figure 6-2. SimpleLink CC2650MODA Module Marking

Table 6-4. Module Descriptions

MARKING	DESCRIPTION
CC2650MODA	Model
YMWLLLC	LTC (lot trace code): <ul style="list-style-type: none"> • Y = Year • M = Month • WLLLLC = Reserved for internal use
ZAT26M1	FCC ID: single modular FCC grant ID
451H-26M1	IC: single modular IC grant ID
	MIC compliance mark
	JATE ID: Japan module grant ID
	ARIB STD-T66 ID: Japan modular grant ID
	Bluetooth compliance mark
CE	CE compliance mark

7 Application, Implementation, and Layout

NOTE

Information in the following applications sections is not part of the TI component specification, and TI does not warrant its accuracy or completeness. TI's customers are responsible for determining suitability of components for their purposes. Customers should validate and test their design implementation to confirm system functionality.

NOTE

TI does not recommend the use of conformal coating or similar material on the module. This coating can lead to localized stress on the solder connections inside the module and impact the module reliability. Use caution during the module assembly process to the final PCB to avoid the presence of foreign material inside the module.

7.1 Application Information

7.1.1 Typical Application Circuit

No external components are required for the operation of the CC2650MODA device. [Figure 7-1](#) shows the application circuit.

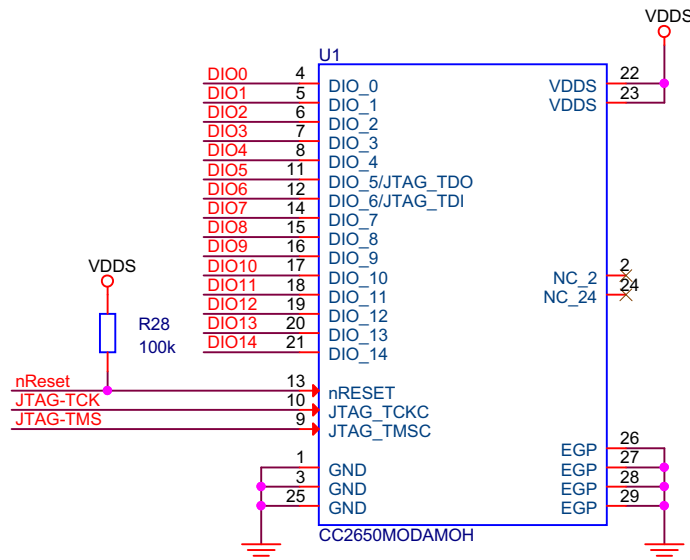

Copyright © 2016, Texas Instruments Incorporated

Figure 7-1. CC2650MODA Application Circuit

7.2 Layout

7.2.1 Layout Guidelines

Use the following guidelines to lay out the CC2650MODA device:

- The module must be placed close to the edge of the PCB.
- TI recommends leaving copper clearance on all PCB layers underneath the antenna area, as shown in [Figure 7-2](#) and [Figure 7-3](#).
- TI recommends using a generous amount of ground vias to stitch together the ground planes on different layers. Several ground vias should be placed close to the exposed ground pads of the module.
- No external decoupling is required.
- The reset line should have an external pullup resistor unless the line is actively driven. Placement of this component is not critical.
- TI recommends leaving a clearance in the top-side copper plane underneath the RF test pads.

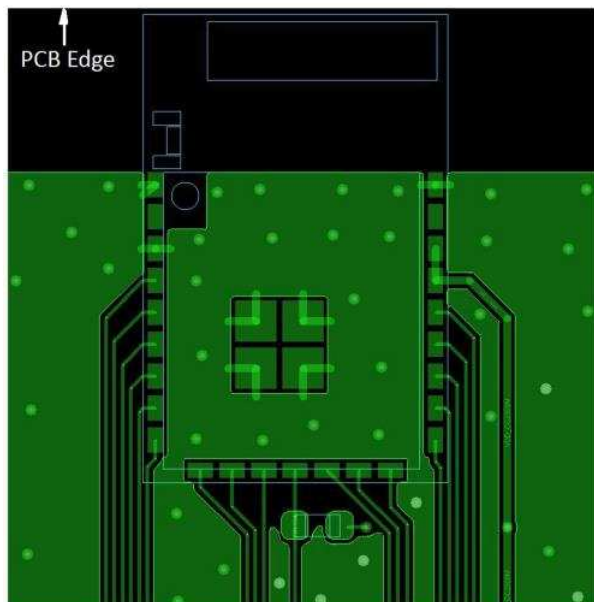

Figure 7-2. Top Layer

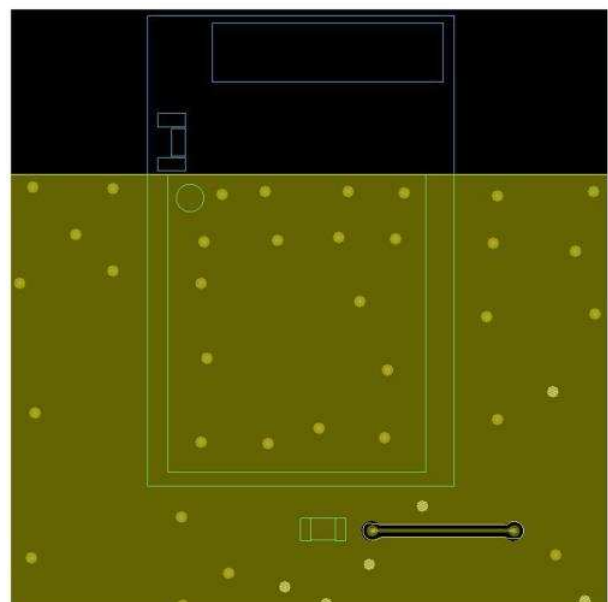

Figure 7-3. Bottom Layer

8 Environmental Requirements and Specifications

8.1 PCB Bending

The PCB follows IPC-A-600J for PCB twist and warpage < 0.75% or 7.5 mil per inch.

8.2 Handling Environment

8.2.1 Terminals

The product is mounted with motherboard through land-grid array (LGA). To prevent poor soldering, do not make skin contact with the LGA portion.

8.2.2 Falling

The mounted components will be damaged if the product falls or is dropped. Such damage may cause the product to malfunction.

8.3 Storage Condition

8.3.1 Moisture Barrier Bag Before Opened

A moisture barrier bag must be stored in a temperature of less than 30°C with humidity under 85% RH. The calculated shelf life for the dry-packed product will be 12 months from the date the bag is sealed.

8.3.2 Moisture Barrier Bag Open

Humidity indicator cards must be blue, < 30%.

8.4 Baking Conditions

Products require baking before mounting if:

- Humidity indicator cards read > 30%
- Temp < 30°C, humidity < 70% RH, over 96 hours

Baking condition: 90°C, 12 to 24 hours

Baking times: 1 time

8.5 Soldering and Reflow Condition

- Heating method: Conventional convection or IR convection
- Temperature measurement: Thermocouple d = 0.1 mm to 0.2 mm CA (K) or CC (T) at soldering portion or equivalent method
- Solder paste composition: Sn/3.0 Ag/0.5 Cu
- Allowable reflow soldering times: 2 times based on the reflow soldering profile (see [Figure 8-1](#))
- Temperature profile: Reflow soldering will be done according to the temperature profile (see [Figure 8-1](#))

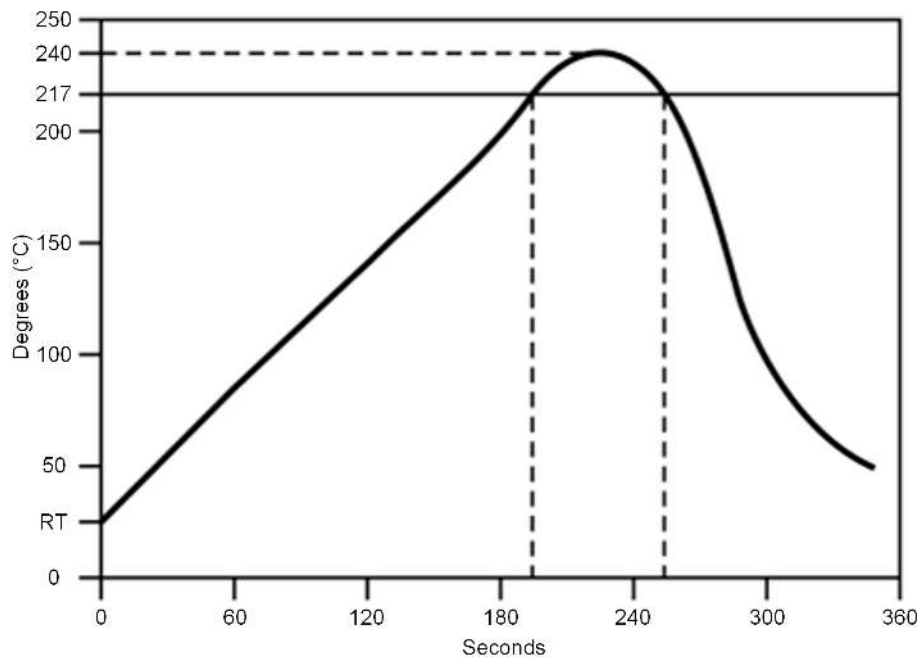

Figure 8-1. Temperature Profile for Evaluation of Solder Heat Resistance of a Component (at Solder Joint)

Table 8-1. Temperature Profile

Profile Elements	Convection or IR ⁽¹⁾
Peak temperature range	235 to 240°C typical (260°C maximum)
Pre-heat / soaking (150 to 200°C)	60 to 120 seconds
Time above melting point	60 to 90 seconds
Time with 5°C to peak	30 seconds maximum
Ramp up	< 3°C / second
Ramp down	< -6°C / second

(1) For details, refer to the solder paste manufacturer’s recommendation.

NOTE

TI does not recommend the use of conformal coating or similar material on the SimpleLink™ module. This coating can lead to localized stress on the solder connections inside the module and impact the module reliability. Use caution during the module assembly process to the final PCB to avoid the presence of foreign material inside the module.

9 Device and Documentation Support

9.1 Device Nomenclature

To designate the stages in the product development cycle, TI assigns prefixes to all part numbers and/or date-code. Each device has one of three prefixes/identifications: X, P, or null (no prefix) (for example, CC2650MODA is in production; therefore, no prefix/identification is assigned).

Device development evolutionary flow:

X Experimental device that is not necessarily representative of the final device's electrical specifications and may not use production assembly flow.

P Prototype device that is not necessarily the final silicon die and may not necessarily meet final electrical specifications.

null Production version of the silicon die that is fully qualified.

Production devices have been characterized fully, and the quality and reliability of the device have been demonstrated fully. TI's standard warranty applies.

Predictions show that prototype devices (X or P) have a greater failure rate than the standard production devices. Texas Instruments recommends that these devices not be used in any production system because their expected end-use failure rate still is undefined. Only qualified production devices are to be used.

TI device nomenclature also includes a suffix with the device family name. This suffix indicates the package type (for example, MOH).

For orderable part numbers of CC2650MODA devices in the MOH package type, see the Package Option Addendum of this document, the TI website (www.ti.com), or contact your TI sales representative.

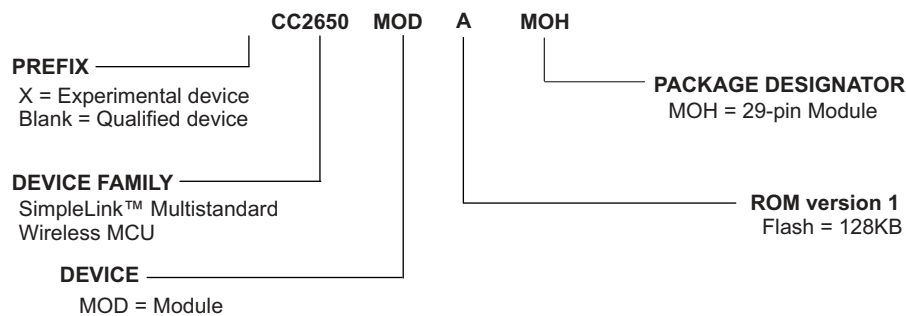

Figure 9-1. Device Nomenclature

9.2 Tools and Software

TI offers an extensive line of development tools, including tools to evaluate the performance of the processors, generate code, develop algorithm implementations, and fully integrate and debug software and hardware modules.

The following products support development of the CC2650MODA device applications:

Software Tools

SmartRF Studio 7:

SmartRF Studio is a PC application that helps designers of radio systems to easily evaluate the RF-IC at an early stage in the design process.

- Test functions for sending and receiving radio packets, continuous wave transmit and receive
- Evaluate RF performance on custom boards by wiring it to a supported evaluation board or debugger
- Can also be used without any hardware, but then only to generate, edit and export radio configuration settings
- Can be used in combination with several development kits for TI's CCxxxx RF-ICs

Sensor Controller Studio:

Sensor Controller Studio provides a development environment for the CC26xx Sensor Controller. The Sensor Controller is a proprietary, power-optimized CPU in the CC26xx, which can perform simple background tasks autonomously and independent of the System CPU state.

- Allows for Sensor Controller task algorithms to be implemented using a C-like programming language
- Outputs a Sensor Controller Interface driver, which incorporates the generated Sensor Controller machine code and associated definitions
- Allows for rapid development by using the integrated Sensor Controller task testing and debugging functionality. This allows for live visualization of sensor data and algorithm verification.

IDEs and Compilers

Code Composer Studio:

- Integrated development environment with project management tools and editor
- Code Composer Studio (CCS) 6.1 and later has built-in support for the CC26xx device family
- Best support for XDS debuggers; XDS100v3, XDS110 and XDS200
- High integration with TI-RTOS with support for TI-RTOS Object View

IAR Embedded Workbench for ARM

- Integrated development environment with project management tools and editor
- IAR EWARM 7.30.3 and later has built-in support for the CC26xx device family
- Broad debugger support, supporting XDS100v3, XDS200, IAR I-Jet and Segger J-Link
- Integrated development environment with project management tools and editor
- RTOS plugin is available for [TI-RTOS](#)

For a complete listing of development-support tools for the CC2650MODA platform, visit the Texas Instruments website at www.ti.com. For information on pricing and availability, contact the nearest TI field sales office or authorized distributor.

9.3 Documentation Support

To receive notification of documentation updates, navigate to the device product folder on ti.com. In the upper right corner, click on *Alert me* to register and receive a weekly digest of any product information that has changed. For change details, review the revision history included in any revised document.

The following documents describe the CC2650MODA device. Copies of these documents are available on the Internet at www.ti.com.

Declaration of Conformity

[CC2650MODA EU Declaration of Conformity \(DoC\)](#)

Errata

[CC2630 and CC2650 SimpleLink™ Wireless MCU Errata](#)

Technical Reference Manual

[CC13x0, CC26x0 SimpleLink™ Wireless MCU](#)

Application Reports

[Running Standalone Bluetooth® low energy Applications on CC2650 Module](#)

[How to Qualify Your Bluetooth\(R\) Low Energy Product](#)

User's Guide

[CC2650 Module BoosterPack™ Getting Started Guide](#)

White Paper

[Which TI Bluetooth® Solution Should I Choose?](#)

More Literature

[Streamline the Challenges of RF Design With Certified Wireless Modules](#)

9.4 Texas Instruments Low-Power RF Website

TI's Low-Power RF website has all the latest products, application and design notes, FAQ section, news and events updates. Go to [Wireless Connectivity: TI's SimpleLink™ Sub-1 GHz Wireless MCUs](#).

9.5 Low-Power RF eNewsletter

The Low-Power RF eNewsletter is up-to-date on new products, news releases, developers' news, and other news and events associated with low-power RF products from TI. The Low-Power RF eNewsletter articles include links to get more online information.

Sign up at: www.ti.com/lprfnewsletter

9.6 Community Resources

The following links connect to TI community resources. Linked contents are provided "AS IS" by the respective contributors. They do not constitute TI specifications and do not necessarily reflect TI's views; see TI's [Terms of Use](#).

TI E2E™ Online Community The TI engineer-to-engineer (E2E) community was created to foster collaboration among engineers. At e2e.ti.com, you can ask questions, share knowledge, explore ideas and help solve problems with fellow engineers.

Texas Instruments Embedded Processors Wiki Established to help developers get started with Embedded Processors from Texas Instruments and to foster innovation and growth of general knowledge about the hardware and software surrounding these devices.

Low-Power RF Online Community Wireless Connectivity Section of the TI E2E Support Community

- Forums, videos, and blogs
- RF design help
- E2E interaction

Join [here](#).

Low-Power RF Developer Network Texas Instruments has launched an extensive network of low-power RF development partners to help customers speed up their application development. The network consists of recommended companies, RF consultants, and independent design houses that provide a series of hardware module products and design services, including:

- RF circuit, low-power RF, and ZigBee design services
- Low-power RF and ZigBee module solutions and development tools
- RF certification services and RF circuit manufacturing

For help with modules, engineering services or development tools:

Search the [Low-Power RF Developer Network](#) to find a suitable partner.

9.7 Additional Information

Texas Instruments offers a wide selection of cost-effective, low-power RF solutions for proprietary and standard-based wireless applications for use in industrial and consumer applications. The selection includes RF transceivers, RF transmitters, RF front ends, modules, and Systems-on-Chips as well as various software solutions for the Sub-1 GHz and 2.4-GHz frequency bands.

In addition, Texas Instruments provides a large selection of support collateral such as development tools, technical documentation, reference designs, application expertise, customer support, third-party and university programs.

The Low-Power RF E2E Online Community provides technical support forums, videos and blogs, and the chance to interact with engineers from all over the world.

With a broad selection of product solutions, end-application possibilities, and a range of technical support, Texas Instruments offers the broadest low-power RF portfolio.

9.8 Trademarks

IAR Embedded Workbench is a registered trademark of IAR Systems AB.

SmartRF, Code Composer Studio, SimpleLink, Z-Stack, LaunchPad, TI-RTOS, BoosterPack, E2E are trademarks of Texas Instruments.

ARM7 is a trademark of ARM Limited (or its subsidiaries).

ARM, Cortex, Thumb are registered trademarks of ARM Limited (or its subsidiaries).

Bluetooth is a registered trademark of Bluetooth SIG, Inc.

CoreMark is a registered trademark of Embedded Microprocessor Benchmark Consortium.

IEEE Std 1241 is a trademark of The Institute of Electrical and Electronics Engineers, Inc.

IEEE is a registered trademark of The Institute of Electrical and Electronics Engineers, Inc.

ZigBee is a registered trademark of ZigBee Alliance, Inc.

ZigBee RF4CE is a trademark of Zigbee Alliance, Inc.

All other trademarks are the property of their respective owners.

9.9 Electrostatic Discharge Caution



This integrated circuit can be damaged by ESD. Texas Instruments recommends that all integrated circuits be handled with appropriate precautions. Failure to observe proper handling and installation procedures can cause damage.

ESD damage can range from subtle performance degradation to complete device failure. Precision integrated circuits may be more susceptible to damage because very small parametric changes could cause the device not to meet its published specifications.

9.10 Export Control Notice

Recipient agrees to not knowingly export or re-export, directly or indirectly, any product or technical data (as defined by the U.S., EU, and other Export Administration Regulations) including software, or any controlled product restricted by other applicable national regulations, received from Disclosing party under this Agreement, or any direct product of such technology, to any destination to which such export or re-export is restricted or prohibited by U.S. or other applicable laws, without obtaining prior authorization from U.S. Department of Commerce and other competent Government authorities to the extent required by those laws.

9.11 Glossary

[TI Glossary](#) This glossary lists and explains terms, acronyms, and definitions.

10 Mechanical, Packaging, and Orderable Information

10.1 Packaging Information

The following pages include mechanical, packaging, and orderable information. This information is the most current data available for the designated devices. This data is subject to change without notice and revision of this document. For browser-based versions of this data sheet, refer to the left-hand navigation.

10.2 PACKAGE OPTION ADDENDUM

10.2.1 PACKAGING INFORMATION

Orderable Device	Status ⁽¹⁾	Package Type	Package Drawing	Pins	Package Qty	Eco Plan ⁽²⁾	Lead/Ball Finish	MSL Peak Temp ⁽³⁾	Op Temp (°C)	Device Marking ^{(4) (5)}
CC2650MODAMOHR	ACTIVE	QFM	MOH	29	1200	Green (RoHS & no Sb/Br)	ENIG	3, 250°C	-40 to 85	CC2650MODA

- (1) The marketing status values are defined as follows:
ACTIVE: Product device recommended for new designs.
LIFEBUY: TI has announced that the device will be discontinued, and a lifetime-buy period is in effect.
NRND: Not recommended for new designs. Device is in production to support existing customers, but TI does not recommend using this part in a new design.
PRE_PROD Unannounced device, not in production, not available for mass market, nor on the web, samples not available.
PREVIEW: Device has been announced but is not in production. Samples may or may not be available.
OBSOLETE: TI has discontinued the production of the device.
- (2) Eco Plan - The planned eco-friendly classification: Pb-Free (RoHS), Pb-Free (RoHS Exempt), or Green (RoHS & no Sb/Br) - please check <http://www.ti.com/productcontent> for the latest availability information and additional product content details.
TBD: The Pb-Free/Green conversion plan has not been defined.
Pb-Free (RoHS): TI's terms "Lead-Free" or "Pb-Free" mean semiconductor products that are compatible with the current RoHS requirements for all 6 substances, including the requirement that lead not exceed 0.1% by weight in homogeneous materials. Where designed to be soldered at high temperatures, TI Pb-Free products are suitable for use in specified lead-free processes.
Pb-Free (RoHS Exempt): This component has a RoHS exemption for either 1) lead-based flip-chip solder bumps used between the die and package, or 2) lead-based die adhesive used between the die and leadframe. The component is otherwise considered Pb-Free (RoHS compatible) as defined above.
Green (RoHS & no Sb/Br): TI defines "Green" to mean Pb-Free (RoHS compatible), and free of Bromine (Br) and Antimony (Sb) based flame retardants (Br or Sb do not exceed 0.1% by weight in homogeneous material)
- (3) MSL, Peak Temp. -- The Moisture Sensitivity Level rating according to the JEDEC industry standard classifications, and peak solder temperature.
- (4) There may be additional marking, which relates to the logo, the lot trace code information, or the environmental category on the device
- (5) Multiple Device markings will be inside parentheses. Only on Device Marking contained in parentheses and separated by a "~" will appear on a device. If a line is indented then it is a continuation of the previous line and the two combined represent the entire Device Marking for that device.

Important Information and Disclaimer: The information provided on this page represents TI's knowledge and belief as of the date that it is provided. TI bases its knowledge and belief on information provided by third parties, and makes no representation or warranty as to the accuracy of such information. Efforts are underway to better integrate information from third parties. TI has taken and continues to take reasonable steps to provide representative and accurate information but may not have conducted destructive testing or chemical analysis on incoming materials and chemicals. TI and TI suppliers consider certain information to be proprietary, and thus CAS numbers and other limited information may not be available for release. In no event shall TI's liability arising out of such information exceed the total purchase price of the TI part(s) at issue in this document sold by TI to Customer on an annual basis.

10.3 PACKAGE MATERIALS INFORMATION

10.3.1 TAPE AND REEL INFORMATION

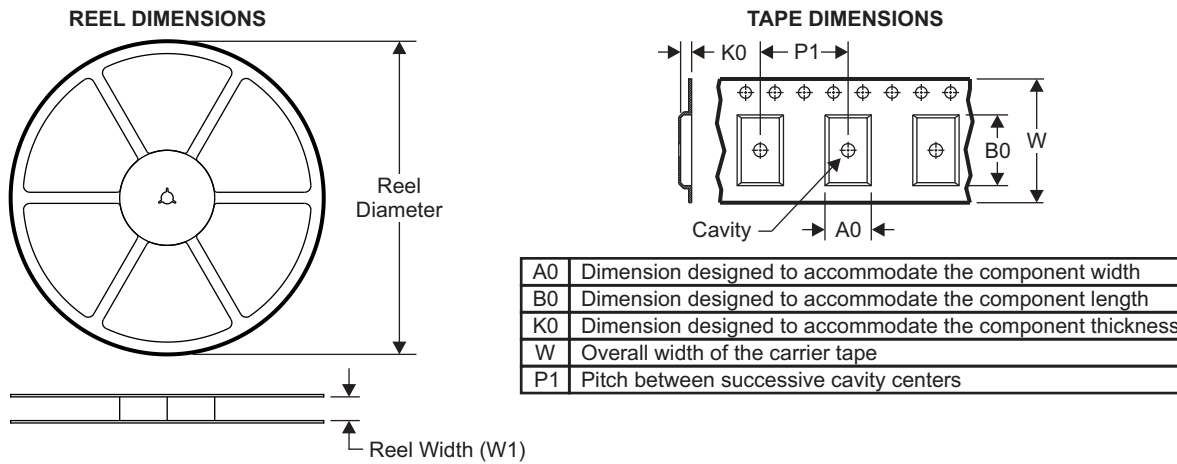

QUADRANT ASSIGNMENTS FOR PIN 1 ORIENTATION IN TAPE

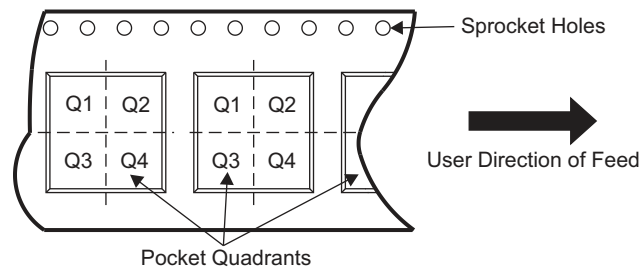

All dimensions are nominal.

Device	Package Type	Package Drawing	Pins	SPQ	Reel Diameter (mm)	Reel Width W1 (mm)	A0 (mm)	B0 (mm)	K0 (mm)	P1 (mm)	W (mm)	Pin1 Quadrant
CC2650MODAMOHR	QFM	MOH	29	1200	330	32.5	11.4	17.4	2.9	16	32	Q1

TAPE AND REEL BOX DIMENSIONS

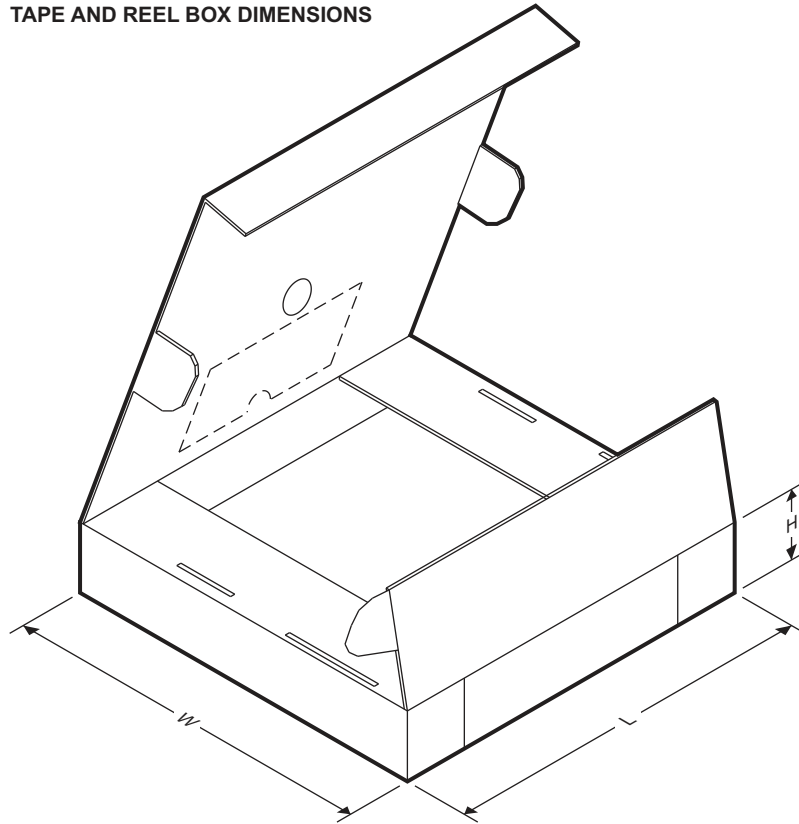

Device	Package Type	Package Drawing	Pins	SPQ	Length (mm)	Width (mm)	Height (mm)
CC2650MODAMOHR	QFM	MOH	29	1200	352	348	56

TAPE AND REEL INFORMATION

QUADRANT ASSIGNMENTS FOR PIN 1 ORIENTATION IN TAPE

*All dimensions are nominal

Device	Package Type	Package Drawing	Pins	SPQ	Reel Diameter (mm)	Reel Width W1 (mm)	A0 (mm)	B0 (mm)	K0 (mm)	P1 (mm)	W (mm)	Pin1 Quadrant
CC2650MODAMOHR	QFM	MOH	29	1200	330.0	32.4	11.4	17.4	2.9	16.0	32.0	Q1

TAPE AND REEL BOX DIMENSIONS



*All dimensions are nominal

Device	Package Type	Package Drawing	Pins	SPQ	Length (mm)	Width (mm)	Height (mm)
CC2650MODAMOHR	QFM	MOH	29	1200	383.0	353.0	58.0

MOH0029A

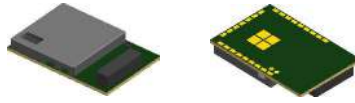

PACKAGE OUTLINE

QFM - 2.69 mm max height

QUAD FLAT MODULE

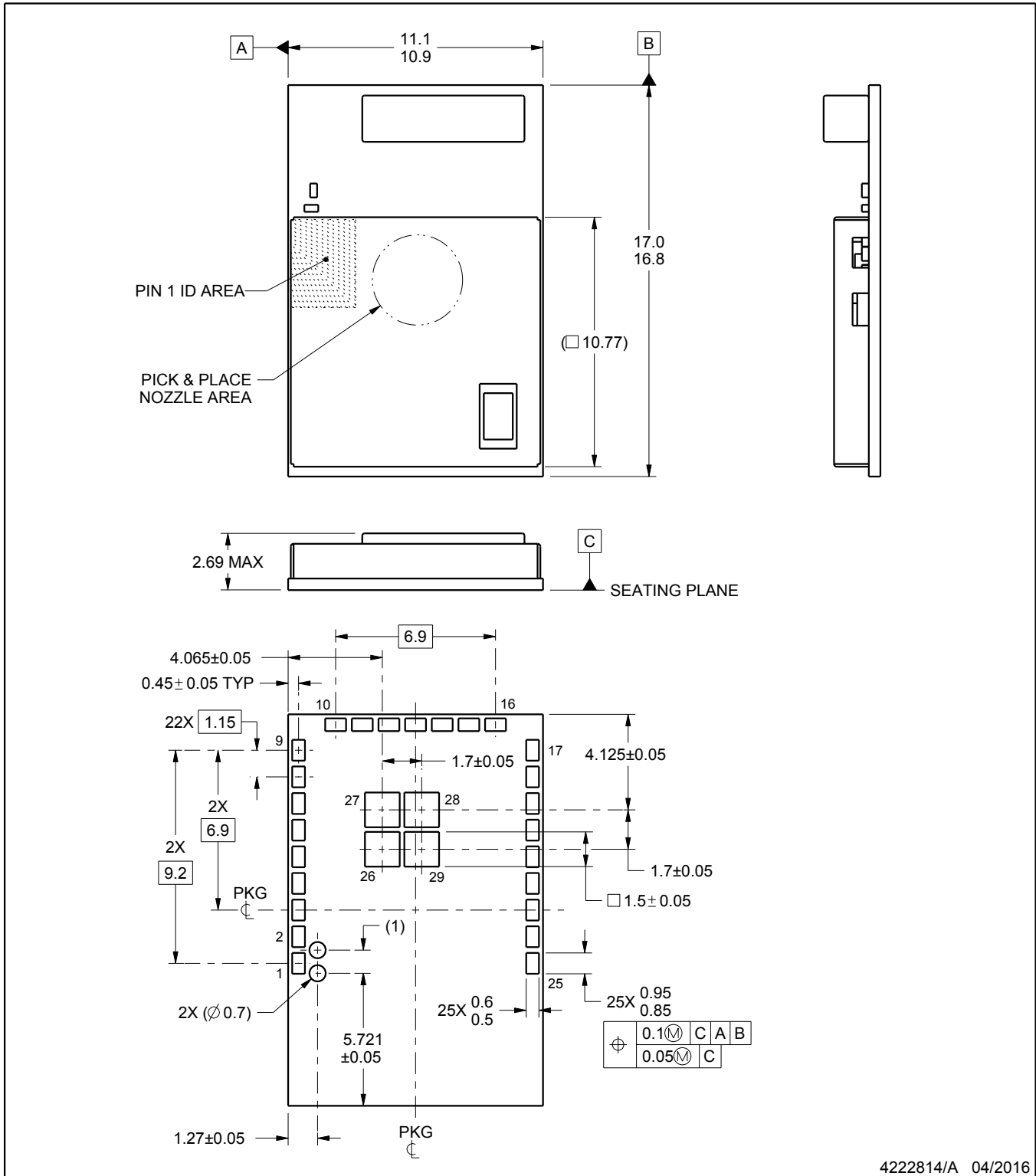

4222814/A 04/2016

NOTES:

1. All linear dimensions are in millimeters. Any dimensions in parenthesis are for reference only. Dimensioning and tolerancing per ASME Y14.5M.
2. This drawing is subject to change without notice.

EXAMPLE BOARD LAYOUT

MOH0029A

QFM - 2.69 mm max height

QUAD FLAT MODULE

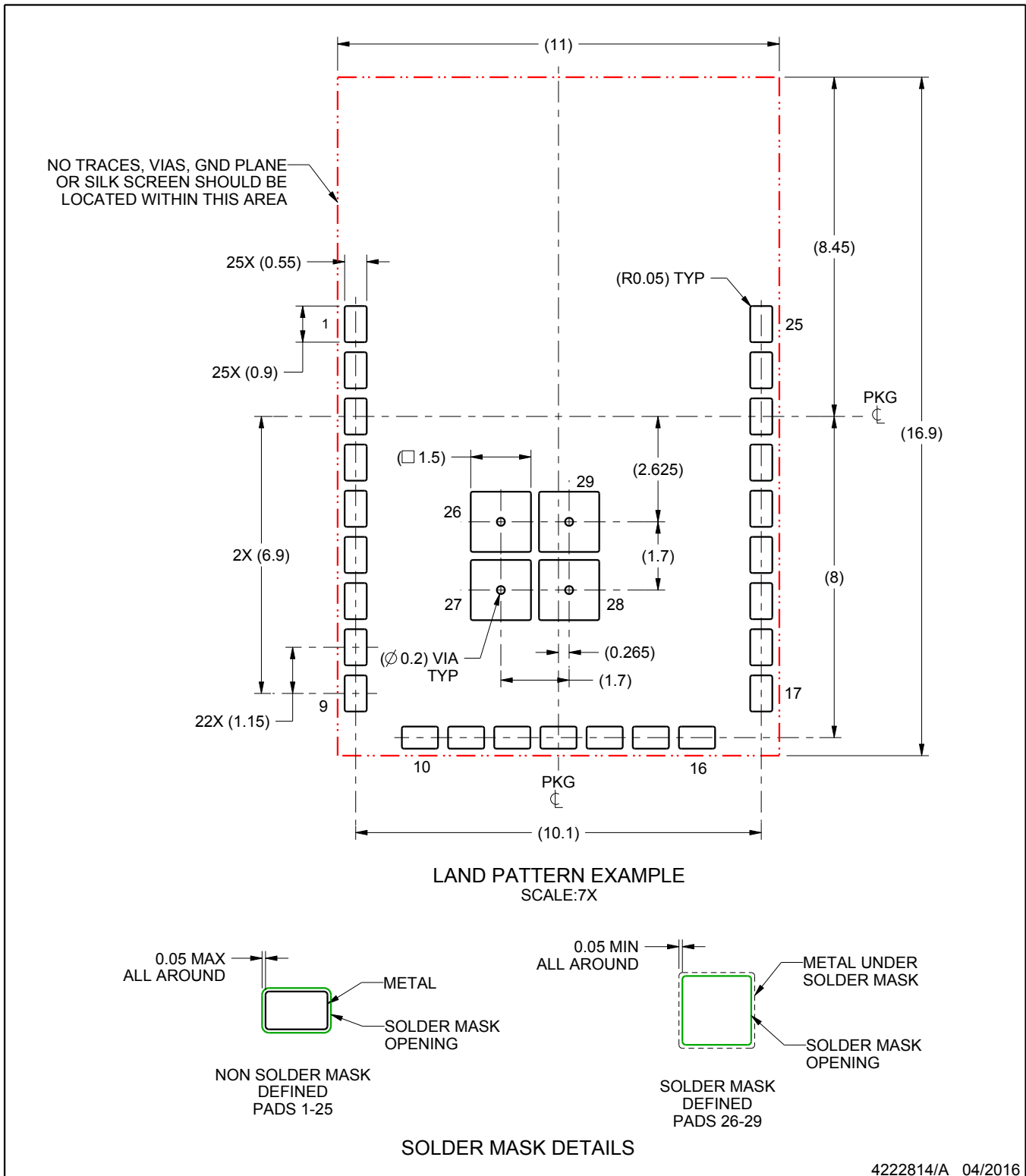

NOTES: (continued)

3. This package is designed to be soldered to a thermal pad on the board. For more information, see Texas Instruments literature number SLUA271 (www.ti.com/lit/slua271).

EXAMPLE STENCIL DESIGN

MOH0029A

QFM - 2.69 mm max height

QUAD FLAT MODULE

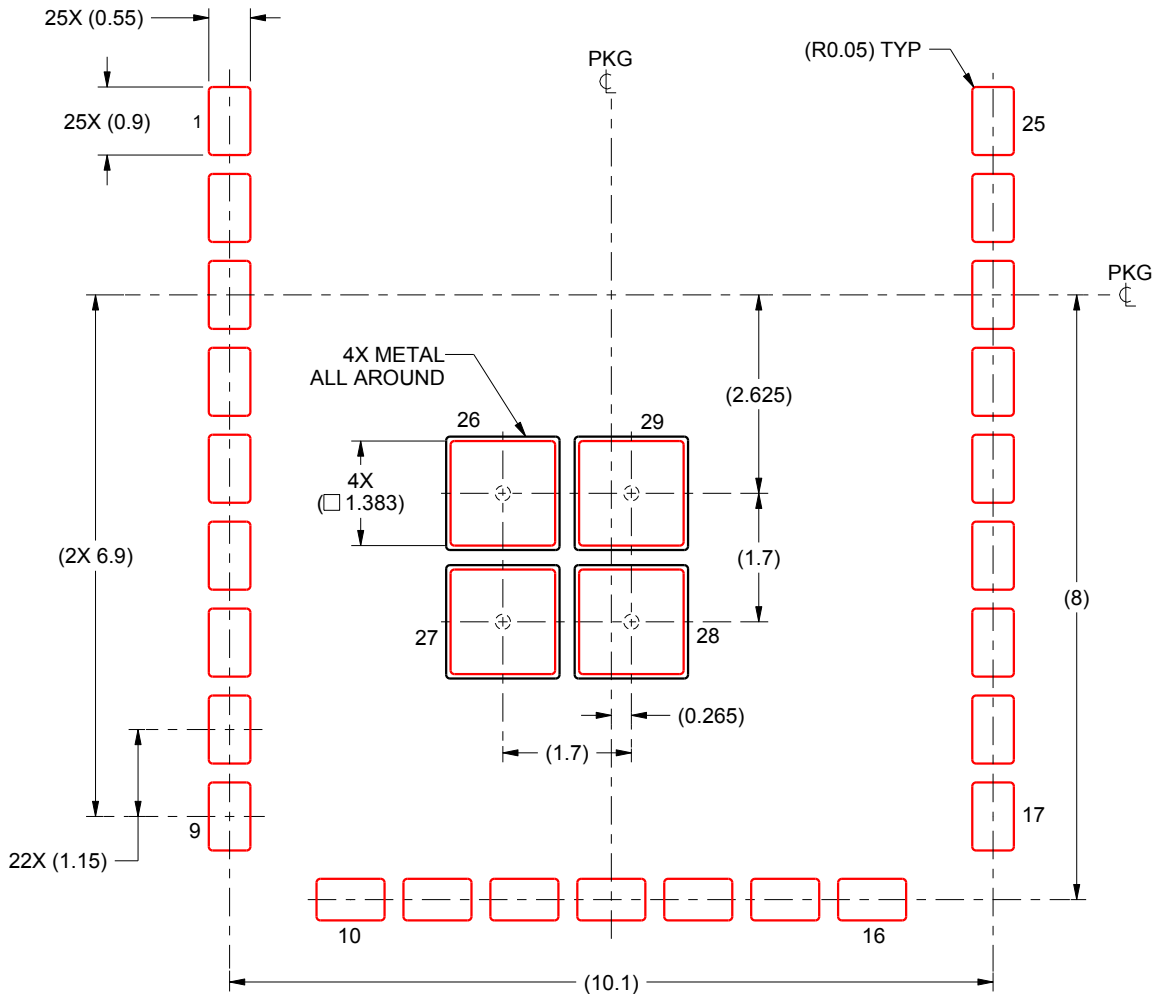

SOLDER PASTE EXAMPLE
 BASED ON 0.125 mm THICK STENCIL
 PRINTED SOLDER COVERAGE BY AREA
 PADS 26-29: 85%
 SCALE:10X

4222814/A 04/2016

NOTES: (continued)

4. Laser cutting apertures with trapezoidal walls and rounded corners may offer better paste release. IPC-7525 may have alternate design recommendations.

IMPORTANT NOTICE AND DISCLAIMER

TI PROVIDES TECHNICAL AND RELIABILITY DATA (INCLUDING DATASHEETS), DESIGN RESOURCES (INCLUDING REFERENCE DESIGNS), APPLICATION OR OTHER DESIGN ADVICE, WEB TOOLS, SAFETY INFORMATION, AND OTHER RESOURCES "AS IS" AND WITH ALL FAULTS, AND DISCLAIMS ALL WARRANTIES, EXPRESS AND IMPLIED, INCLUDING WITHOUT LIMITATION ANY IMPLIED WARRANTIES OF MERCHANTABILITY, FITNESS FOR A PARTICULAR PURPOSE OR NON-INFRINGEMENT OF THIRD PARTY INTELLECTUAL PROPERTY RIGHTS.

These resources are intended for skilled developers designing with TI products. You are solely responsible for (1) selecting the appropriate TI products for your application, (2) designing, validating and testing your application, and (3) ensuring your application meets applicable standards, and any other safety, security, or other requirements. These resources are subject to change without notice. TI grants you permission to use these resources only for development of an application that uses the TI products described in the resource. Other reproduction and display of these resources is prohibited. No license is granted to any other TI intellectual property right or to any third party intellectual property right. TI disclaims responsibility for, and you will fully indemnify TI and its representatives against, any claims, damages, costs, losses, and liabilities arising out of your use of these resources.

TI's products are provided subject to TI's Terms of Sale (<https://www.ti.com/legal/termsofsale.html>) or other applicable terms available either on [ti.com](https://www.ti.com) or provided in conjunction with such TI products. TI's provision of these resources does not expand or otherwise alter TI's applicable warranties or warranty disclaimers for TI products.

Mailing Address: Texas Instruments, Post Office Box 655303, Dallas, Texas 75265
Copyright © 2021, Texas Instruments Incorporated