

microSD™/TransFlash™ Card Connectors

DM3 Series

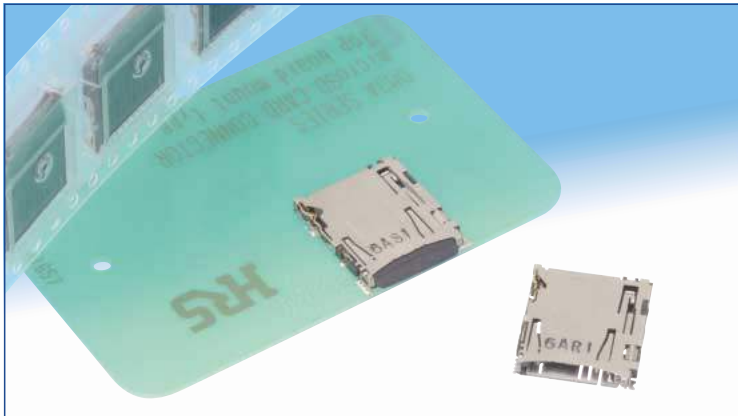

Extremely small size

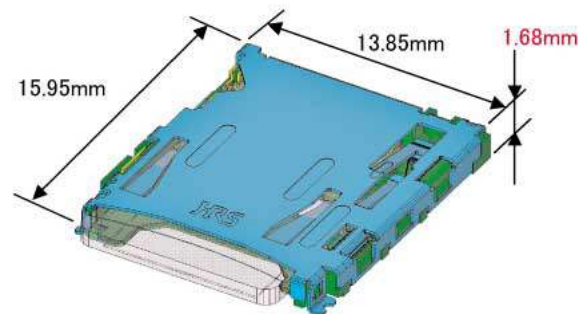

Features

1. Extremely small size

The width of 13.85 mm, length of 15.95 mm and height of 1.68 mm makes this connector smallest on the market.

2. Card fall-out prevention

Built-in card tray and unique push-push ejection mechanism (patent pending) prevents accidental card ejection or fall-out.

3. Reverse card insertion protection

Unique card slot metal tabs (patent pending) protect connector from damage when the card is attempted to be inserted in reverse.

The card may be easily removed and re-inserted correctly.

4. Long card ejection distance

Despite it's small size the push-push ejection will eject card for the large distance of 4.0 mm allowing easy hold and removal of the card.

5. Multiple ground and shield connections

4 connection points of the metal cover (at each corner of the connector) to the printed circuit board surface assure reliable ground connections.

6. Rigid and strong construction

All plastic components held by the metal top created a strong and rigid connector while retaining it's extremely small size.

7. Card detection switch

The card detection switch is normally open.

8. Exposed termination leads

Easy inspection and rework of solder joints.

9. RoHS compliant

All components and materials comply with the requirements of the EU Directive 2002/95/EC.

Applications

Mobile phones, digital cameras, PDA's and any other portable device requiring use of small size, high durability microSD™ memory card connectors.

*microSD is a trademark of the SD Association.

Card fall-out prevention

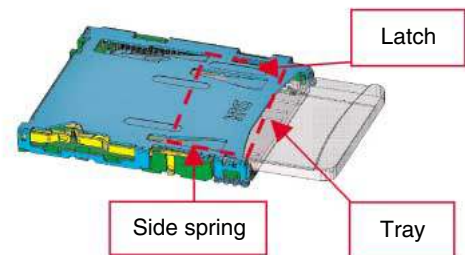

Reverse card insertion prevention

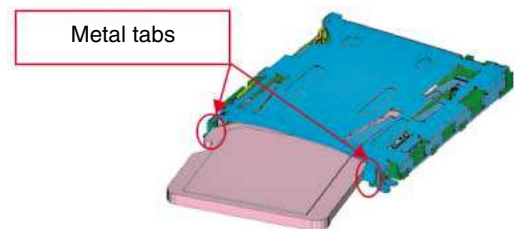

Long card ejection distance (4 mm)

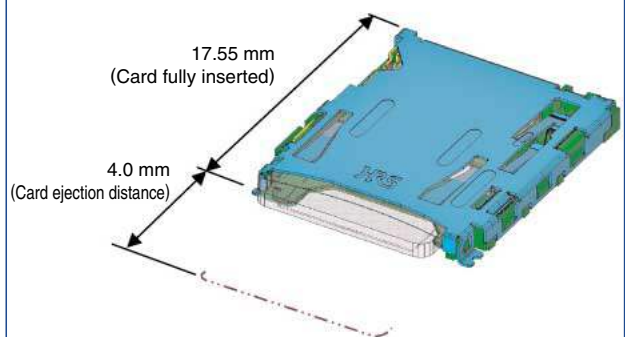

■ Product Specifications

Ratings	Current rating: 0.5A Voltage rating: 125V AC	Operating temperature range: -20°C to +85°C (Note) Storage temperature range: -40°C to +85°C	Operating humidity range: Relative humidity 95% max. (No condensation)
----------------	---	---	---

Item	Specification	Conditions
1. Insulation resistance	1000 M ohms min. (Initial value)	500V DC
2. Withstanding voltage	No flashover or insulation breakdown.	500V AC / one minute
3. Contact resistance	100m ohms max. (Initial value)	1mA
4. Vibration	No electrical discontinuity of 100 ns or more.	Frequency: 10 to 55 Hz, single amplitude of 0.75mm, 2 hours / 3 axis
5. Humidity	Contact resistance: 40m ohms max. from initial value Insulation resistance: 100M ohms min.	96 hours at 40°C ± 2°C and humidity of 90% to 95%.
6. Temperature cycle	Contact resistance: 40m ohms max. from initial value Insulation resistance: 100M ohms min.	Temperature: -55°C → +5°C to +35°C → +85°C → +5°C to +35°C Duration: 30 → 5 → 30 → 5 (Minutes) 5 cycles
7. Durability (mating/un-mating)	Contact resistance: 40m ohms max. from initial value.	10,000 cycles at 400 to 600 cycles per hour
8. Resistance to soldering heat	No deformation of components affecting performance.	Reflow: At the recommended temperature profile Manual soldering: 350°C for 3 seconds

Note 1: Includes temperature rise caused by current flow.

Note 2: The term “storage” refers to products stored for long period of time prior to mounting and use. Operating temperature range and humidity range covers non-conducting condition of installed connectors in storage, shipment or during transportation.

■ Materials and Finish

Part	Material	Finish	Remarks
Insulator	Highly heat-resistant resin	Color: Black	UL94V-0
Contacts	Copper alloy	Contact area: Gold plated Lead area: Gold plated	_____
Guide cover	Copper alloy	_____	_____
Other components	Stainless steel Piano wire	_____	_____

■ Ordering information

DM3 A - SF - PEJ - *

① ② ③ ④ ⑤

① Series name: DM3	④ Card ejection code: Push insert/push eject
② Connector typeA...Standard receptacle Number of contacts: 8	⑤ Positioning boss type Blank : Without positioning boss 2 : With positioning boss
③ Termination type SF : Right-angle SMT (standard mounting)	

Standard (Top board mounting - Without positioning boss)



Part number	CL No.	RoHS
DM3A-SF-PEJ	609-0014-1	YES

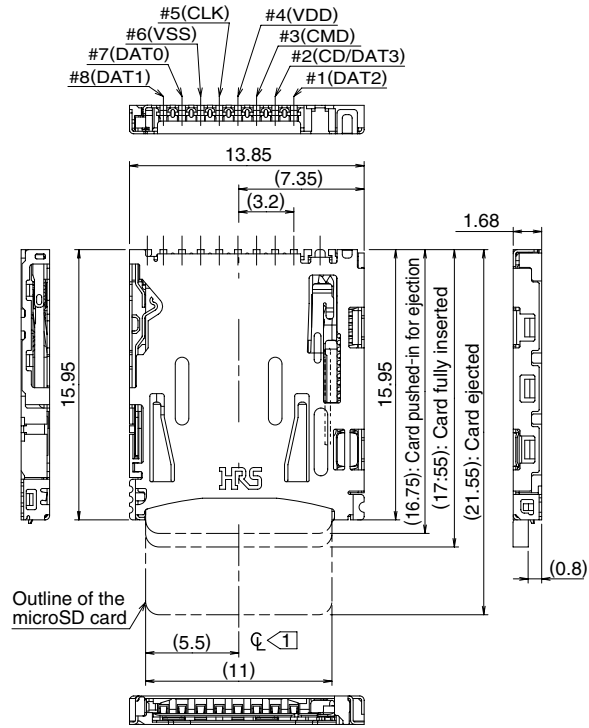

Recommended PC board mounting pattern

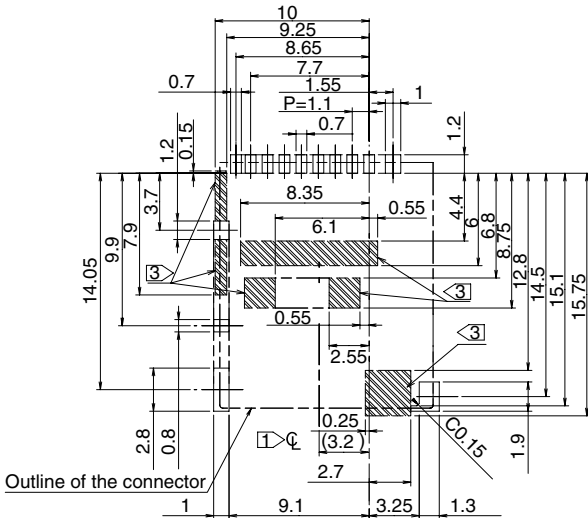

Note ① ϕ indicates the center line of the microSD card slot.

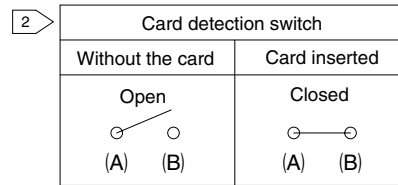

③ No conductive traces

Card insertion direction

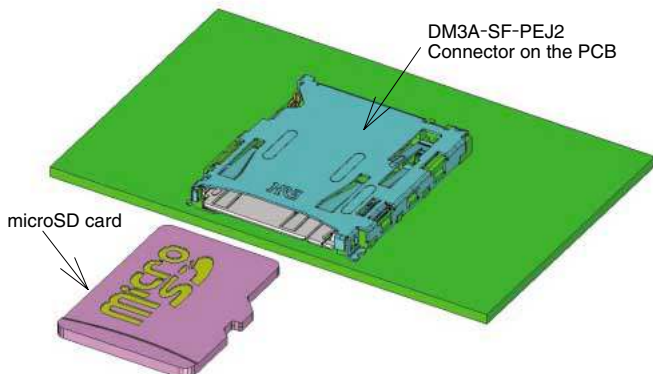

■ Packaging Specifications

- Embossed carrier tape dimensions 1,500pieces per reel

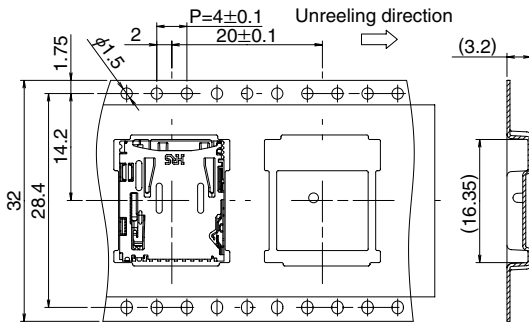

- Reel dimensions

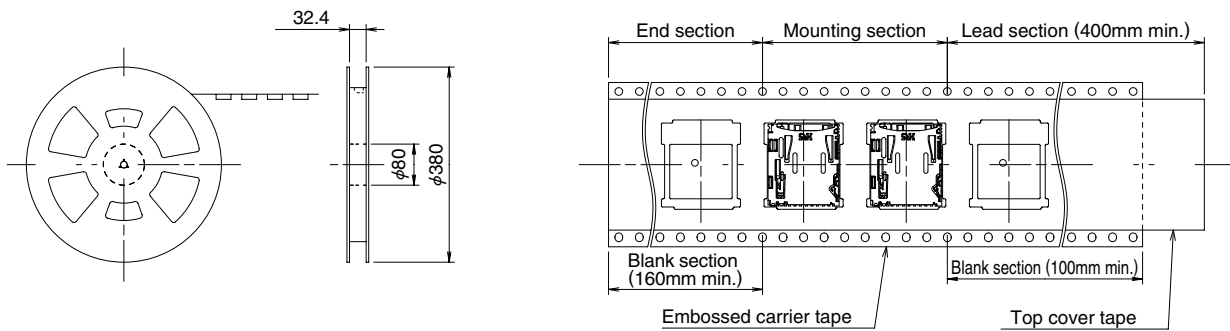

■ Recommended Temperature Profile

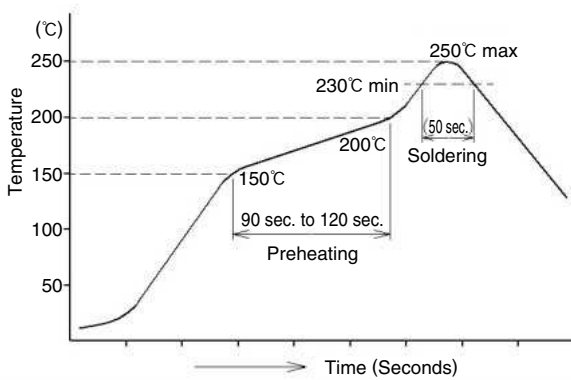

<Recommended conditions >

- Reflow system : IR/Hot air reflow
- Environment : Room air
- Solder composition : Paste, 96.5%Sn / 3.0%Ag / 0.5%Cu (M705-GRN360-K2-V manufactured by Senju Metal Industry Co., Ltd.)
- Test board : Glass epoxy 60mm x 100mm x 1mm thick
- Metal mask thickness : 0.12 mm

This temperature profile is based on the above conditions. In individual applications the actual temperature may vary, depending on solder paste type, volume/thickness and board size/thickness. Consult your solder paste and equipment manufacturer for specific recommendations.

■Precautions and use recommendations

1. Do not immerse or clean the entire connector with cleaning solutions as this may affect proper operation of the ejection mechanism and electrical performance of the connector.
Clean ONLY the soldered termination areas.
2. Do not apply excessive force to connector when handling or after installation on the PC board.
3. The connector will reliably connect and function with the correctly inserted microSD™ or TransFlash™ cards. The connector will not allow reverse insertion of the card.
Do NOT force reverse oriented card in to the connector as this may cause permanent damage to the card or connector.
4. Do not use force when removing the inserted card from the connector.
5. Protective cover recommendations.
To avoid accidental damage to the connector or electrical discontinuity when the device may be accidentally dropped it is recommended to have a removable, sliding or hinged protective cover, as shown on the illustration below.

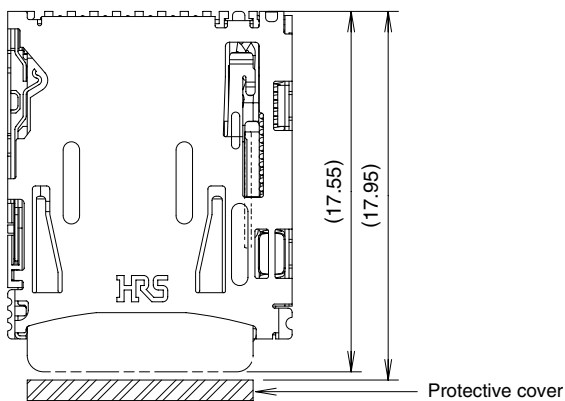

6. Recommended application area for surface mounting adhesive
Surface mounting adhesive must be applied on the PCB only in the area indicated on the illustration below.
Excessive amount of the adhesive may affect the soldered termination leads.
Use only the minimum required amount of adhesive.

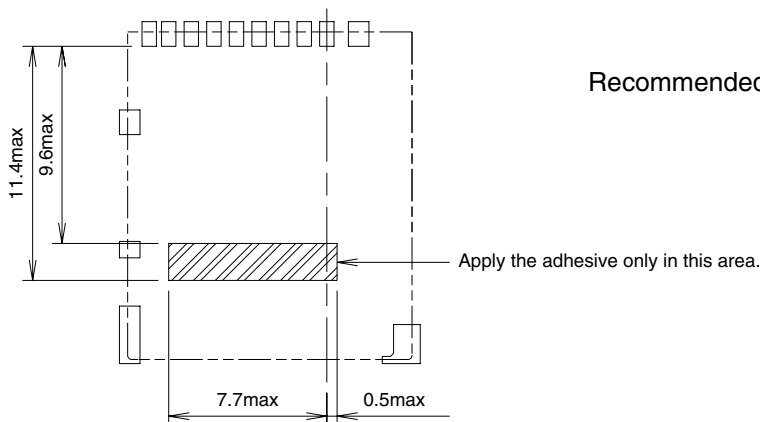

Recommended adhesive: SOMAKOTE IR-010H-3
(Manufactured by Somar Corporation)

7. The connector must be correctly mounted on the PC board before the card can be inserted. Do not insert card in the un-mounted connector.

8. Mounting on the Flexible Printed Circuit (FPC)

To assure correct performance it is recommended that a flat reinforcement plate 0.3 mm min. thick be used under the FPC.

9. To assure card guidance during insertion and the protection of the exposed edge when fully inserted it is recommended that the users housing be designed as illustrated below.

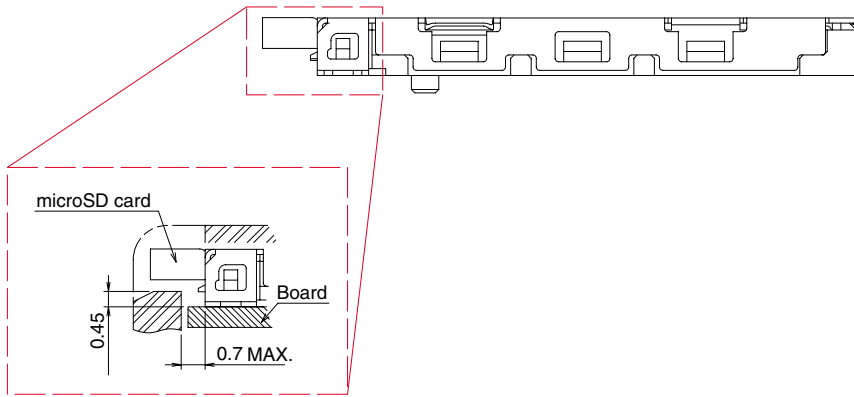

10. The edge of the moveable tray may be visually slanted as shown on the illustration below. This has no effect on connector performance.

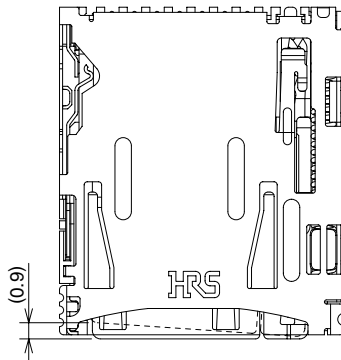

11. Small visible residual manufacturing oils or tooling marks do not affect connector performance.

12. Repeated insertions and removal of the cards may leave some marks on the card itself. This will have no effect on the connector performance.

13. The card detection contacts are exposed.

Exercise extra caution during handling and installation on the PC board as to avoid damage or contamination to them.

