

## 8-Channel VARIABLE GAIN AMPLIFIER

 Check for Samples: [VCA8617](#)

### FEATURES

- **3V OPERATION**
- **LOW INPUT NOISE:**
  - $1.05\text{nV}/\sqrt{\text{Hz}}$  at  $f_{\text{IN}} = 5\text{MHz}$
- **EXTREMELY LOW POWER OPERATION:**
  - **103mW/CHANNEL**
- **INTEGRATED LOW-PASS, ANTI-ALIASING BUTTERWORTH FILTER**
  - **14.5MHz BANDWIDTH**
- **INTEGRATED INPUT CLAMP DIODES**
- **DIFFERENTIAL OUTPUT**
- **INTEGRATED INPUT LNA**
- **READABLE CONTROL REGISTERS**
- **INTEGRATED CONTINUOUS WAVE (CW) PROCESSOR**

### DESCRIPTION

The VCA8617 is an 8-channel variable gain amplifier ideally suited to portable ultrasound applications. Excellent dynamic performance enables use in low-power, high-performance portable applications. Each channel consists of a 20dB gain Low-Noise pre-Amplifier (LNA) and a Variable Gain Amplifier (VGA). The differential outputs of the LNA can be switched through the 8x10 cross-point switch, which is programmable through the serial interface input port.

The output of the LNA is fed directly into the VGA stage. The VGA consists of two parts, a Voltage-Controlled Attenuator (VCA) and a Programmable Gain Amplifier (PGA). The gain and gain range of the PGA can be digitally configured separately. The gain of the PGA can vary between four discrete settings of 25dB, 30dB, 35dB, and 40dB. The VCA has four programmable maximum attenuation settings: 29dB, 33dB, 36.5dB, and 40dB. Also, the VCA can be continuously varied by a control voltage from 0dB to a maximum of 29dB, 33dB, 36.5dB, and 40dB.

The output of the PGA feeds directly into an integrated low-pass filter.

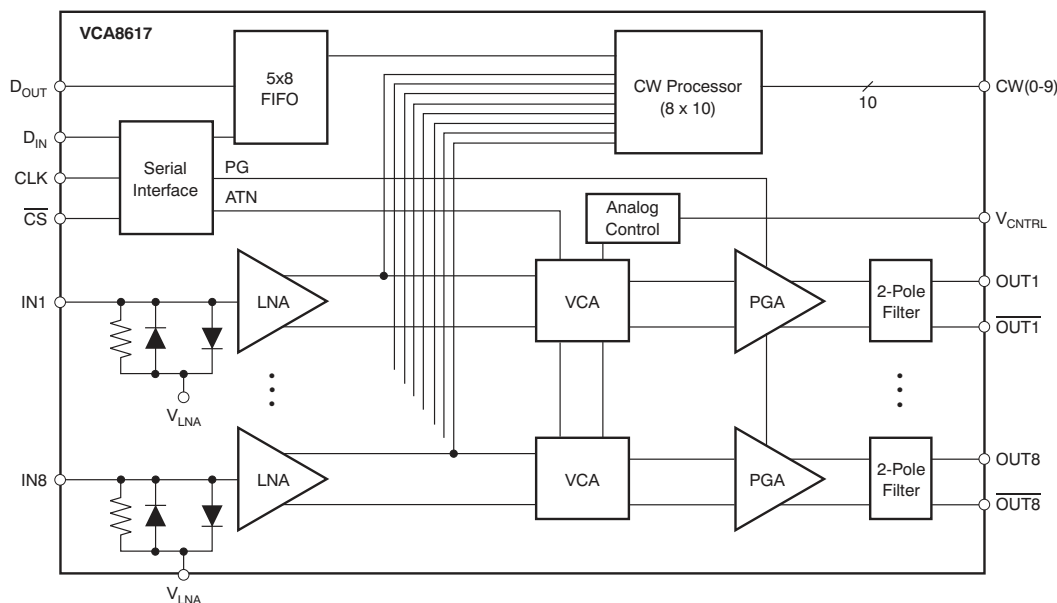

Please be aware that an important notice concerning availability, standard warranty, and use in critical applications of Texas Instruments semiconductor products and disclaimers thereto appears at the end of this data sheet.

SPI is a trademark of Motorola, Inc.

All other trademarks are the property of their respective owners.



This integrated circuit can be damaged by ESD. Texas Instruments recommends that all integrated circuits be handled with appropriate precautions. Failure to observe proper handling and installation procedures can cause damage.

ESD damage can range from subtle performance degradation to complete device failure. Precision integrated circuits may be more susceptible to damage because very small parametric changes could cause the device not to meet its published specifications.

### ORDERING INFORMATION<sup>(1)</sup>

PRODUCT	PACKAGE-LEAD	PACKAGE DESIGNATOR	SPECIFIED TEMPERATURE RANGE	PACKAGE MARKING	ORDERING NUMBER	TRANSPORT MEDIA, QUANTITY
VCA8617	TQFP-64	PAG	-40°C to +85°C	VCA8617PAG	VCA8617PAGT	Tape and Reel, 250
					VCA8617PAGR	Tape and Reel, 1500

- (1) For the most current package and ordering information, see the Package Option Addendum at the end of this document, or see the TI web site at [www.ti.com](http://www.ti.com).

### ABSOLUTE MAXIMUM RATINGS<sup>(1)</sup>

Over operating free-air temperature range unless otherwise noted.

+AV <sub>DD</sub>	+3.6V
Analog Input	-0.3V to +AV <sub>DD</sub> + 0.3V
Logic Input	-0.3V to +AV <sub>DD</sub> + 0.3V
Case Temperature	+100°C
Junction Temperature	+150°C
Storage Temperature	+150°C
Thermal Resistance, Junction-to-Ambient ( $\theta_{JA}$ )	66.6°C/W
Thermal Resistance, Junction-to-Case ( $\theta_{JC}$ )	4.3°C/W

- (1) Stresses above these ratings may cause permanent damage. Exposure to absolute maximum conditions for extended periods may degrade device reliability. These are stress ratings only, and functional operation of the device at these or any other conditions beyond those specified is not implied.

**ELECTRICAL CHARACTERISTICS:  $AV_{DD} = DV_{DD} = 3V$** 

At  $T_A = +25^\circ C$ , load resistance = 1k $\Omega$  on each output to ground, unless otherwise noted. The input to the preamp (LNA) is single-ended; pre-amp gain is fixed at +20dB,  $f_{IN} = 2MHz$ , PG = 01, ATN = 00, and the output from the VCA is differential, unless otherwise noted.

PARAMETER	CONDITIONS	VCA8617			UNIT
		MIN	TYP	MAX	
Input Voltage Noise (TGC, Full Signal Chain)	$f_{IN} = 5MHz$		1.05		nV/ $\sqrt{Hz}$
Input Voltage Noise (CW)	$f_{IN} = 5MHz$		1.15		nV/ $\sqrt{Hz}$
<b>PREAMPLIFIER (LNA)</b>					
Input Resistance			4.5		k $\Omega$
Input Capacitance			52		pF
Input Bias Current			1		nA
Maximum Input Voltage <sup>(1)</sup>			200		mV <sub>PP</sub>
Output Swing (Differential)			2		V <sub>PP</sub>
Bandwidth			100		MHz
Gain			20		dB
Input Common-Mode Voltage			1.4		V
<b>ACCURACY</b>					
Gain Slope	0.2V – 1.7V, $V_{CTRL}$		18		dB/V
Gain Error	0.2V – 1.7V, $V_{CTRL}$			1.7	dB
Output Offset Voltage	Differential		0.65		mV
<b>GAIN CONTROL INTERFACE</b>					
Input Voltage ( $V_{CACTRL}$ ) Range			0 to 2.0		V
Input Resistance			1		M $\Omega$
Response Time	40dB Gain Change, PG = 11		0.2		$\mu s$
<b>POWER SUPPLY</b>					
Specified Operating Range		2.85	3.0	3.15	V
Power-Down Delay			5		$\mu s$
Power-Up Delay			100		$\mu s$
Power Dissipation (TGC Mode)	Operating All Channels		825	950	mW
Power-Down			9		mW
<b>PROGRAMMABLE VGA AND LOW-PASS FILTER</b>					
-3dB Cutoff (low-pass)			14.5		MHz
-3dB Cutoff (high-pass)			400		kHz
Slew Rate			300		V/ $\mu s$
Output Impedance			10		$\Omega$
Crosstalk			49		dB
Output Common-Mode Voltage			1.5		V
Output Swing (Differential) <sup>(2)</sup>				2	V <sub>PP</sub>
3rd-Harmonic Distortion			-65	-50	dB
2nd-Harmonic Distortion			-60	-50	dB
Group Delay Variation			$\pm 3$		ns
<b>CONTINUOUS WAVE PROCESSOR</b>					
V/I Converter Transconductance		17	20	23	mA/V
Output Common-Mode Voltage			1.4		V
Maximum Output Swing			3.4		mA <sub>PP</sub>

(1) Under conditions when input signal is within linear range of LNA.

(2) Under conditions when signal is within linear range of output amplifier.

**ELECTRICAL CHARACTERISTICS:  $AV_{DD} = DV_{DD} = 3V$  (continued)**

At  $T_A = +25^\circ\text{C}$ , load resistance = 1k $\Omega$  on each output to ground, unless otherwise noted. The input to the preamp (LNA) is single-ended; pre-amp gain is fixed at +20dB,  $f_{IN} = 2\text{MHz}$ , PG = 01, ATN = 00, and the output from the VCA is differential, unless otherwise noted.

PARAMETER	CONDITIONS	VCA8617			UNIT
		MIN	TYP	MAX	
<b>LOGIC INPUTS</b>					
$V_{IN}$ LOW (input low voltage)		0		0.6	V
$V_{IN}$ HIGH (input high voltage)		2.1		$DV_{DD}$	V
Input Current				$\pm 1$	$\mu\text{A}$
Input Pin Capacitance			5		pF
Clock Input Frequency		10k		25M	Hz

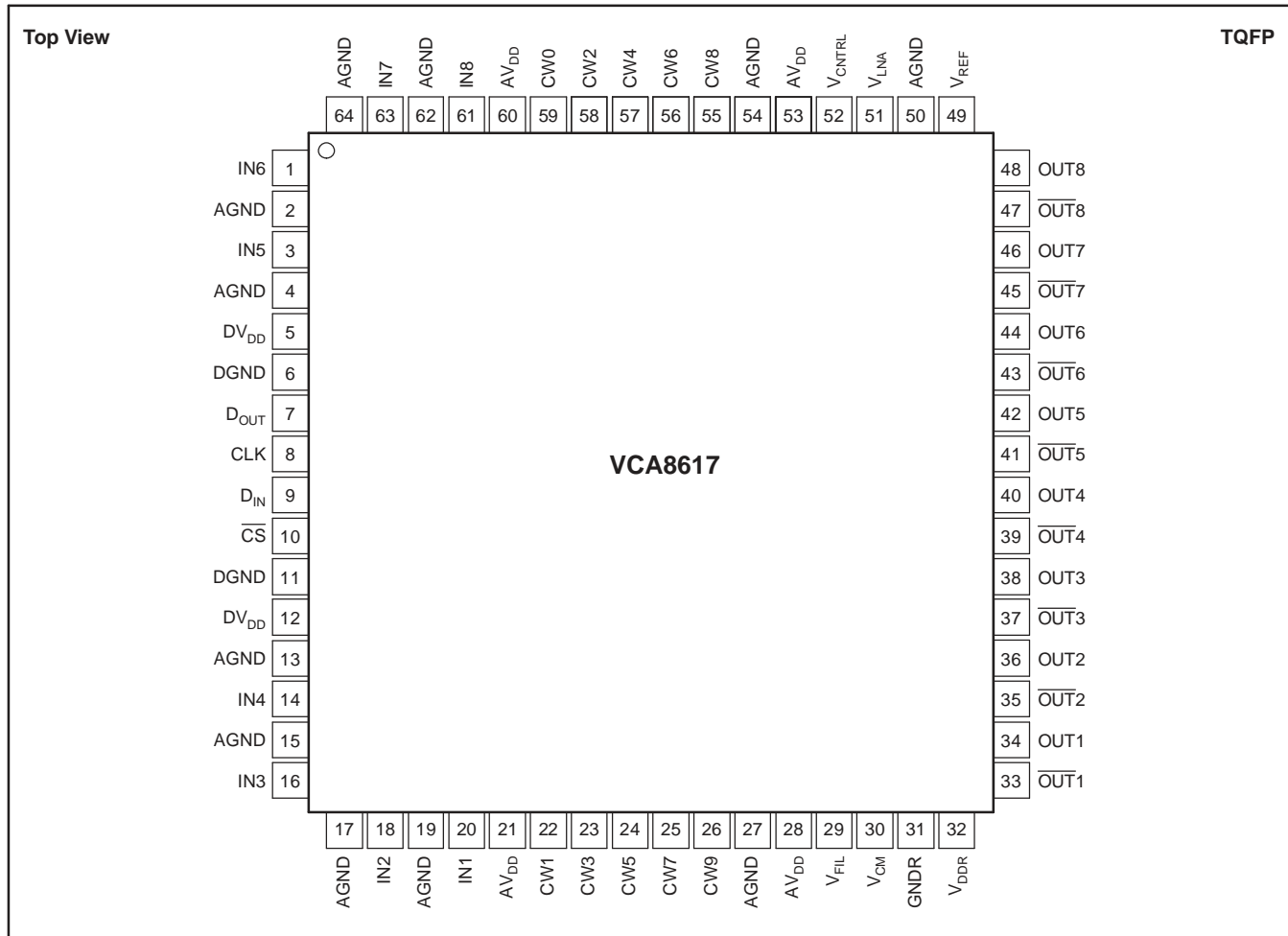

### PIN DESCRIPTIONS

PIN	DESIGNATOR	DESCRIPTION
5, 12	DV <sub>DD</sub>	Digital Supplies
2, 4, 13, 15, 17, 19, 27, 50, 54, 62, 64	AGND	Analog Ground
1, 3, 14, 16, 18, 20, 61, 63	IN(1-8)	Single-Ended LNA Inputs
22-26, 55-59	CW(0-9)	Continuous Wave Outputs
51	V <sub>LNA</sub>	Reference Voltage for LNA—internally generated; requires external bypass cap.
29	V <sub>FIL</sub>	Reference Voltage for Output Filter—internally generated; requires external bypass cap.
30	V <sub>CM</sub>	Common-Mode Voltage—internally generated; requires external bypass cap.
34, 36, 38, 40, 42, 44, 46, 48	OUT(1-8)	Positive Polarity PGA Outputs
33, 35, 37, 39, 41, 43, 45, 47	$\overline{\text{OUT}}(1-8)$	Negative Polarity PGA Outputs
52	V <sub>CNTRL</sub>	Attenuator Control Input
9	D <sub>IN</sub>	Serial Data Input Pin
10	$\overline{\text{CS}}$	Serial Data Chip Select
8	CLK	Serial Data Input Clock
7	D <sub>OUT</sub>	Serial Data Output Pin
21, 28, 53, 60	AV <sub>DD</sub>	Analog Supplies
6, 11	DGND	Digital Ground
49	V <sub>REF</sub>	Reference Voltage for Attenuator—internally generated; requires external bypass cap.
32	V <sub>DDR</sub>	Reference Power Supply
31	GNDR	Reference Ground

## INPUT REGISTER BIT MAPS

**Table 1. Byte 1—Control Byte Register Map**

BIT #	NAME	DESCRIPTION
LSB	1	Start bit; always a '1'—40-bit countdown starts upon first '1' after chip select.
1	$\overline{W}/R$	1 = Write, 0 = Read—Read prevents latching of DATA only—Control register remains latched with existing data.
2	P <sub>WR</sub>	Power-Down control bit (all channels); 1 = Power-Down Mode Enabled (default), 0 = Normal Operation.
3	A0	Attenuator control bit (ATN).
4	A1	Attenuator control bit (ATN).
5	Mode	1 = TGC Control mode (CW powered down), 0 = Doppler mode (TGC powered down)
6	PG0	LSB of PGA Gain Control
MSB	PG1	MSB of PGA Gain Control

**Table 2. Byte 2—First Data Byte**

BIT #	NAME	DESCRIPTION
LSB	Data 1:0	Channel 1, LSB of Matrix Control
1	Data 1:1	Channel 1, Matrix Control
2	Data 1:2	Channel 1, Matrix Control
3	Data 1:3	Channel 1, MSB of Matrix Control
4	Data 2:0	Channel 2, LSB of Matrix Control
5	Data 2:1	Channel 2, Matrix Control
6	Data 2:2	Channel 2, Matrix Control
MSB	Data 2:3	Channel 2, MSB of Matrix Control

**Table 3. Byte 3—Second Data Byte**

BIT #	NAME	DESCRIPTION
LSB	Data 3:0	Channel 3, LSB of Matrix Control
1	Data 3:1	Channel 3, Matrix Control
2	Data 3:2	Channel 3, Matrix Control
3	Data 3:3	Channel 3, MSB of Matrix Control
4	Data 4:0	Channel 4, LSB of Matrix Control
5	Data 4:1	Channel 4, Matrix Control
6	Data 4:2	Channel 4, Matrix Control
MSB	Data 4:3	Channel 4, MSB of Matrix Control

**Table 4. Byte 4—Third Data Byte**

<b>BIT #</b>	<b>NAME</b>	<b>DESCRIPTION</b>
LSB	Data 5:0	Channel 5, LSB of Matrix Control
1	Data 5:1	Channel 5, Matrix Control
2	Data 5:2	Channel 5, Matrix Control
3	Data 5:3	Channel 5, MSB of Matrix Control
4	Data 6:0	Channel 6, LSB of Matrix Control
5	Data 6:1	Channel 6, Matrix Control
6	Data 6:2	Channel 6, Matrix Control
MSB	Data 6:3	Channel 6, MSB of Matrix Control

**Table 5. Byte 5—Fourth Data Byte**

<b>BIT #</b>	<b>NAME</b>	<b>DESCRIPTION</b>
LSB	Data 7:0	Channel 7, LSB of Matrix Control
1	Data 7:1	Channel 7, Matrix Control
2	Data 7:2	Channel 7, Matrix Control
3	Data 7:3	Channel 7, MSB of Matrix Control
4	Data 8:0	Channel 8, LSB of Matrix Control
5	Data 8:1	Channel 8, Matrix Control
6	Data 8:2	Channel 8, Matrix Control
MSB	Data 8:3	Channel 8, MSB of Matrix Control

## WRITE/READ TIMING

Generally follows SPI Timing Specification:

- All writes and reads are 40 bits at a time. Each byte consists of 8 bits;
- Separate write and read data lines;
- Reads will follow the same bit stream pattern seen in the write cycle;
- Reads will extract data from the FIFO, not the latched register;
- $D_{OUT}$  data is continuously available and need not be enabled with a read cycle. Selecting a read cycle in the control register only prevents latching of data. The control register remains latched.

## WRITE CYCLE TIMING

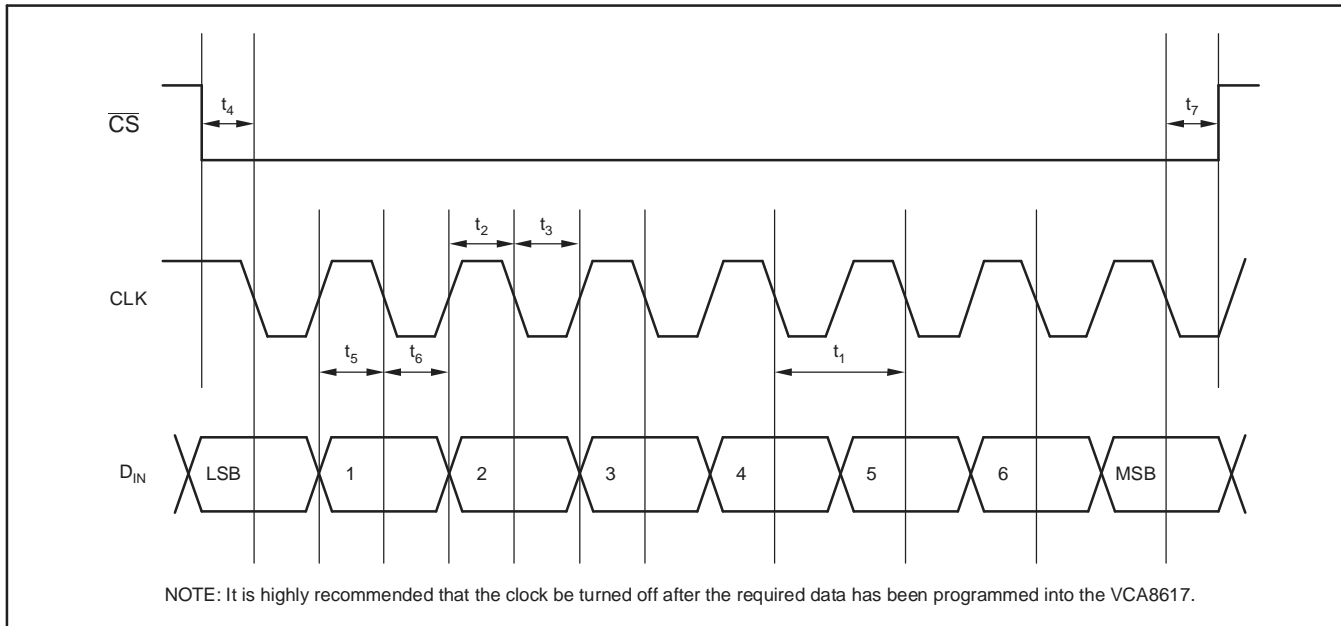

## SERIAL PORT TIMING TABLE

Chip Select ( $\overline{CS}$ ) must be held low (active LOW) during transfer.  $\overline{CS}$  can be held permanently low.

PARAMETER	DESCRIPTION	MIN	TYP	MAX	UNITS
$t_1$	Serial CLK Period	40			ns
$t_2$	Serial CLK HIGH Time	20			ns
$t_3$	Serial CLK LOW Time	20			ns
$t_4$	$\overline{CS}$ Falling Edge to Serial CLK Falling Edge	10			ns
$t_5$	Data Setup Time	5			ns
$t_6$	Data Hold Time	5			ns
$t_7$	Serial CLK Falling Edge to $\overline{CS}$ Rising Edge	10			ns

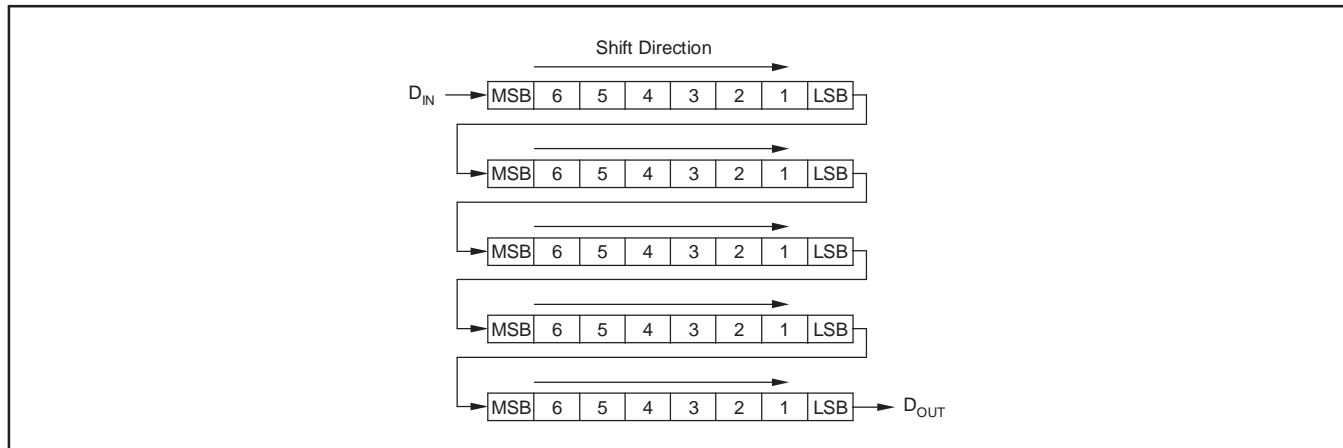

## DATA SHIFT SEQUENCE

**Table 6. Maximum Attenuation**

A1, A0	MAXIMUM ATTENUATION
0, 0	29dB
0, 1	33dB
1, 0	36.5dB
1, 1	40dB

**Table 7. PGA Gain Settings**

PG1, PG0	PGA GAIN
0, 0	25dB
0, 1	30dB
1, 0	35dB
1, 1	40dB

**Table 8. CW Coding for Each Channel**

CHANNEL	CW CODING (MSB, LSB)	CHANNEL DIRECTED TO:
0	0000	Output 0
1	0001	Output 1
2	0010	Output 2
3	0011	Output 3
4	0100	Output 4
5	0101	Output 5
6	0110	Output 6
7	0111	Output 7
8	1000	Output 8
9	1001	Output 9
10	1010	Channel tied to +V (internal)
11	1011	Channel tied to +V (internal)
12	1100	Channel tied to +V (internal)
13	1101	Channel tied to +V (internal)
14	1110	Channel tied to +V (internal)
15	1111	Channel tied to +V (internal)

Applies to bytes 2 through 5.

**TYPICAL CHARACTERISTICS:  $AV_{DD} = DV_{DD} = 3V$**

At  $T_A = +25^\circ C$ , load resistance =  $1k\Omega$  on each output to ground; the input to the preamp (LNA) is single-ended; pre-amp gain is fixed at  $+20dB$ ,  $f_{IN} = 2MHz$ ,  $PG = 01$ ,  $ATN = 00$ , and the output from the VCA is differential, unless otherwise noted.

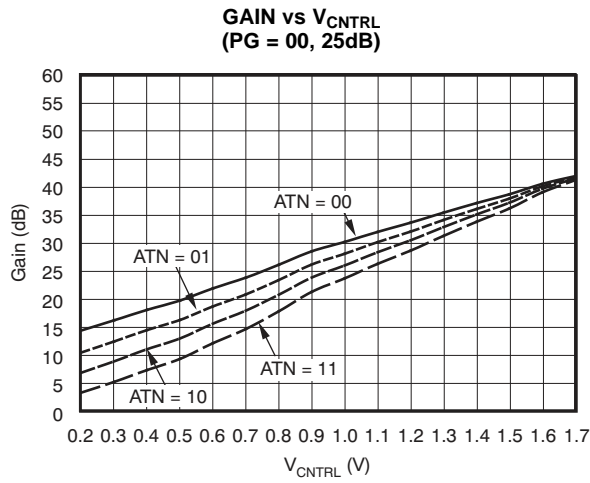

Figure 1.

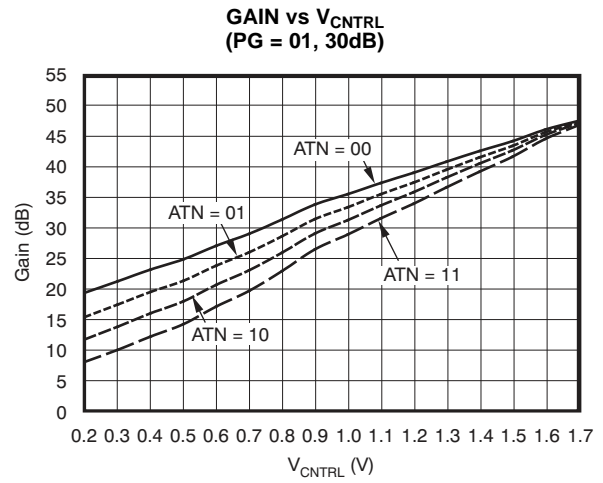

Figure 2.

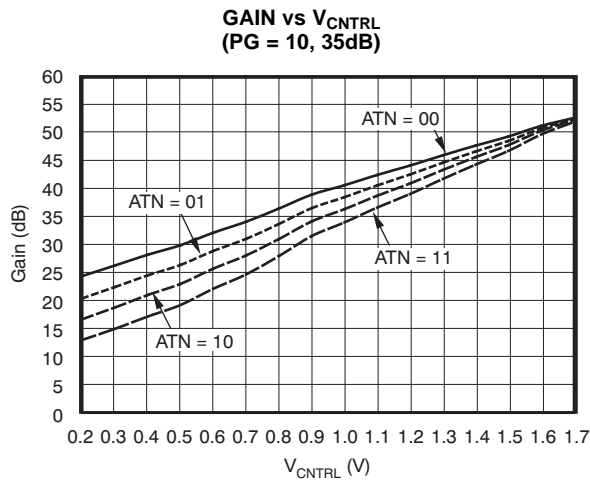

Figure 3.

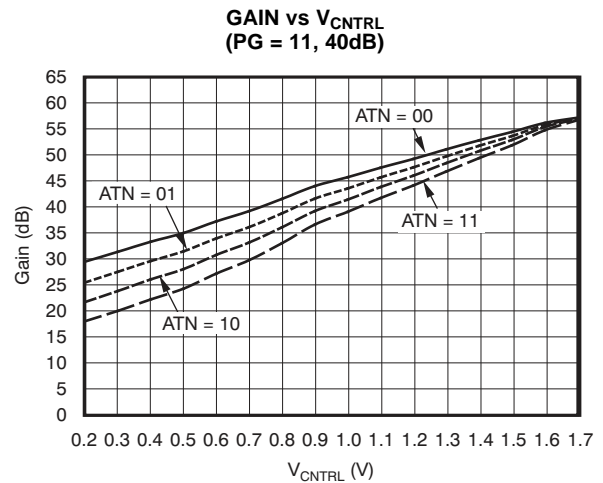

Figure 4.

**TYPICAL CHARACTERISTICS:  $AV_{DD} = DV_{DD} = 3V$  (continued)**

At  $T_A = +25^\circ C$ , load resistance = 1k $\Omega$  on each output to ground; the input to the preamp (LNA) is single-ended; pre-amp gain is fixed at +20dB,  $f_{IN} = 2MHz$ , PG = 01, ATN = 00, and the output from the VCA is differential, unless otherwise noted.

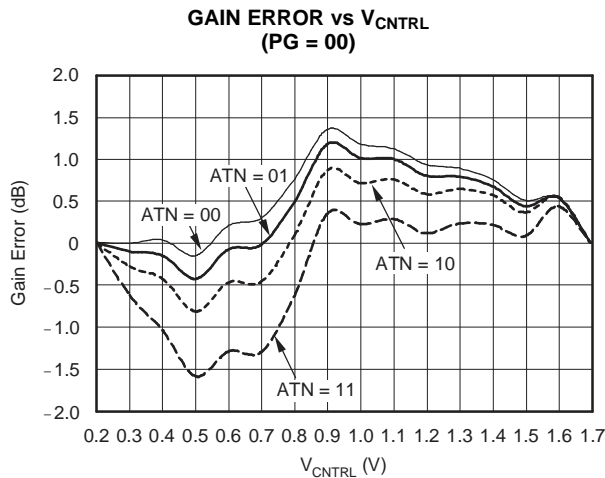

Figure 5.

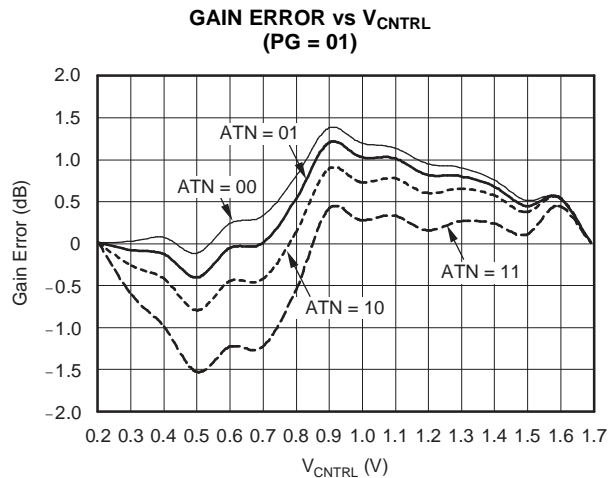

Figure 6.

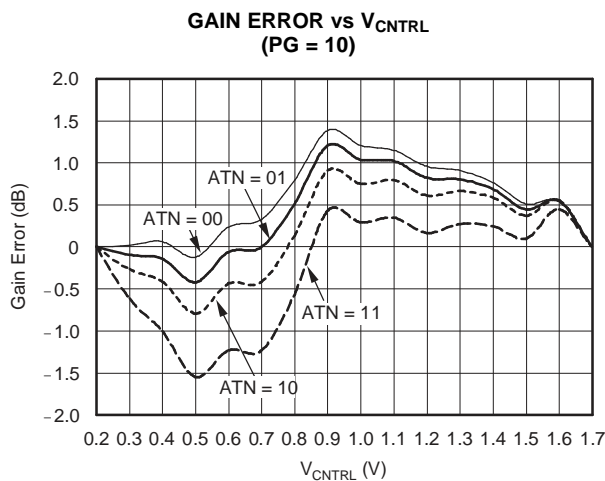

Figure 7.

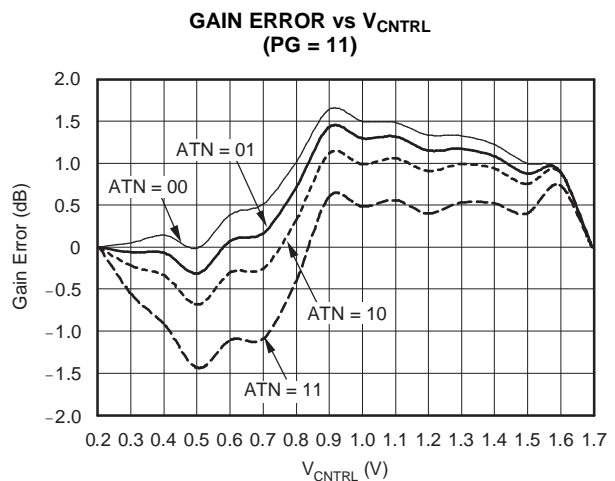

Figure 8.

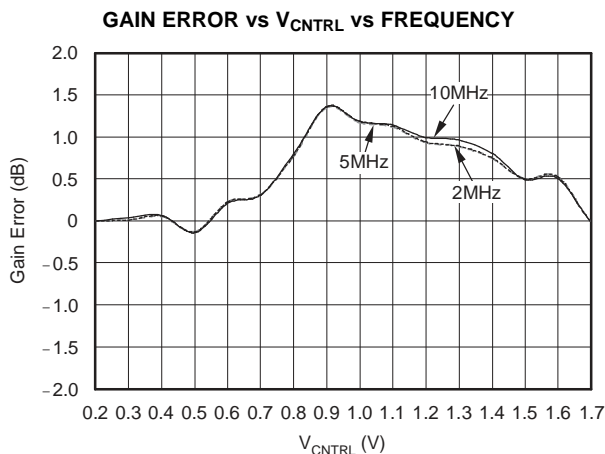

Figure 9.

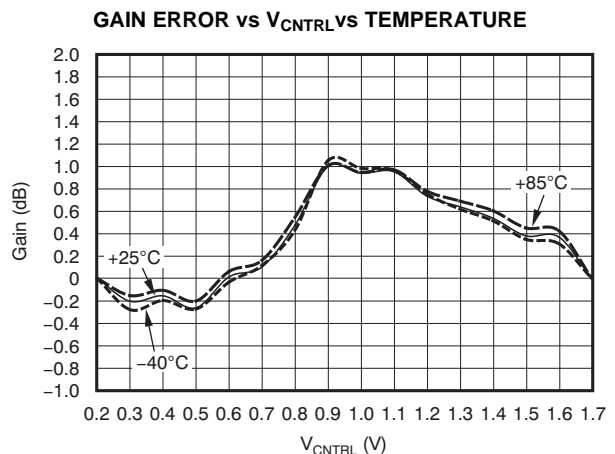

Figure 10.

**TYPICAL CHARACTERISTICS:  $AV_{DD} = DV_{DD} = 3V$  (continued)**

At  $T_A = +25^\circ C$ , load resistance =  $1k\Omega$  on each output to ground; the input to the preamp (LNA) is single-ended; pre-amp gain is fixed at  $+20dB$ ,  $f_{IN} = 2MHz$ ,  $PG = 01$ ,  $ATN = 00$ , and the output from the VCA is differential, unless otherwise noted.

**TIME GAIN CONTROL (TGC) CURRENT vs TEMPERATURE**

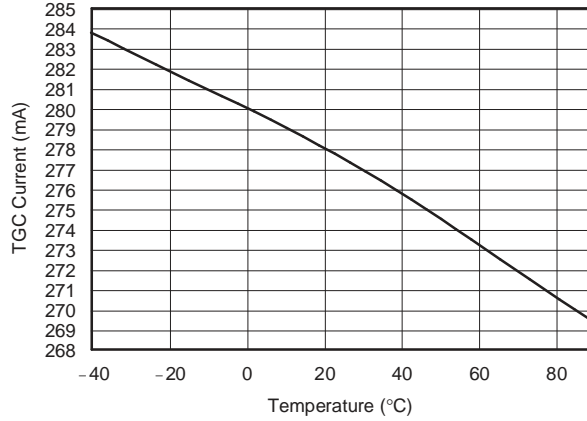

Figure 11.

**CONTINUOUS WAVE (CW) CURRENT vs TEMPERATURE**

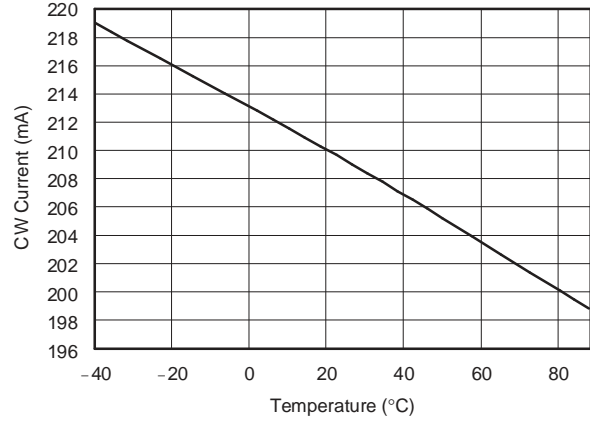

Figure 12.

**GAIN MATCH ( $V_{CNTRL} = 0.2V$ )**

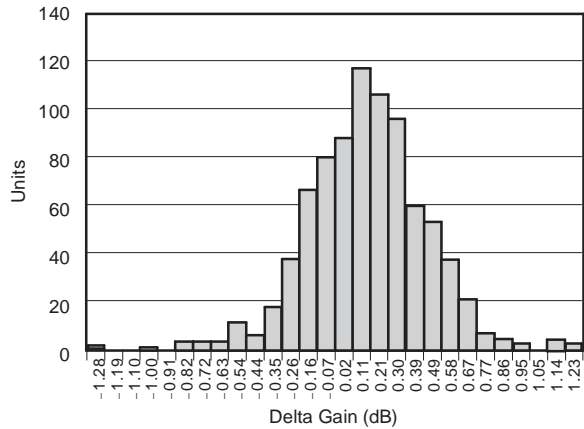

Figure 13.

**GAIN MATCH ( $V_{CNTRL} = 1.7V$ )**

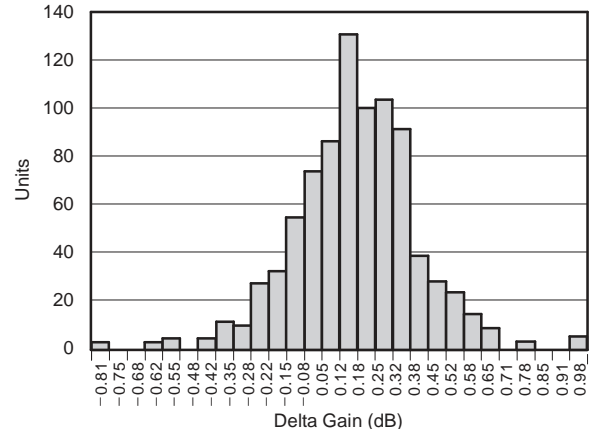

Figure 14.

**TYPICAL CHARACTERISTICS:  $AV_{DD} = DV_{DD} = 3V$  (continued)**

At  $T_A = +25^\circ C$ , load resistance =  $1k\Omega$  on each output to ground; the input to the preamp (LNA) is single-ended; pre-amp gain is fixed at  $+20dB$ ,  $f_{IN} = 2MHz$ ,  $PG = 01$ ,  $ATN = 00$ , and the output from the VCA is differential, unless otherwise noted.

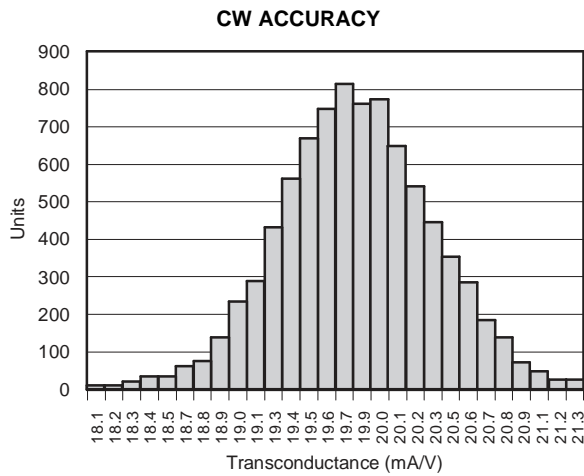

Figure 15.

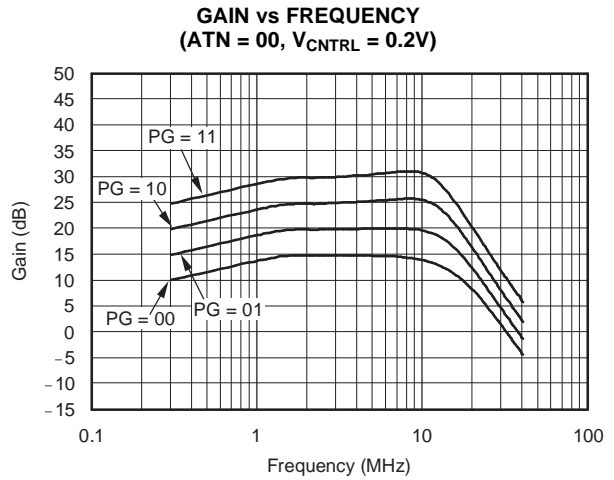

Figure 16.

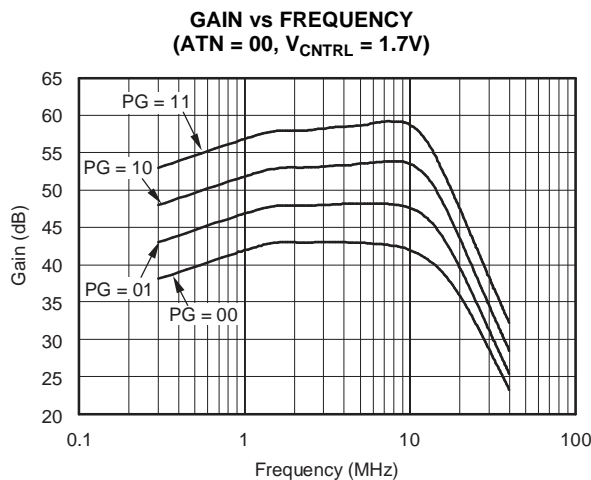

Figure 17.

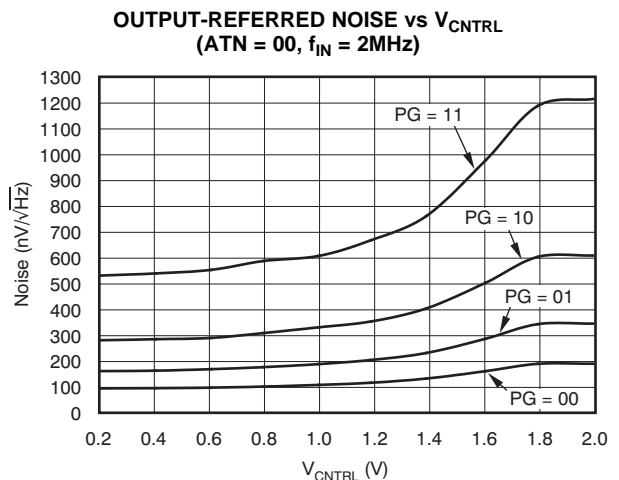

Figure 18.

**TYPICAL CHARACTERISTICS:  $AV_{DD} = DV_{DD} = 3V$  (continued)**

At  $T_A = +25^\circ C$ , load resistance =  $1k\Omega$  on each output to ground; the input to the preamp (LNA) is single-ended; pre-amp gain is fixed at  $+20dB$ ,  $f_{IN} = 2MHz$ ,  $PG = 01$ ,  $ATN = 00$ , and the output from the VCA is differential, unless otherwise noted.

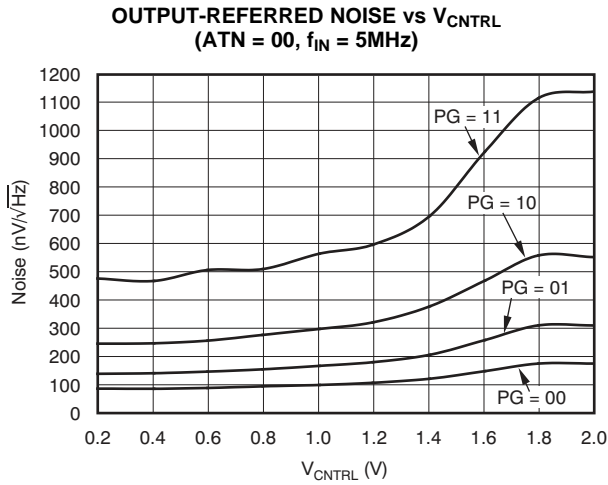

Figure 19.

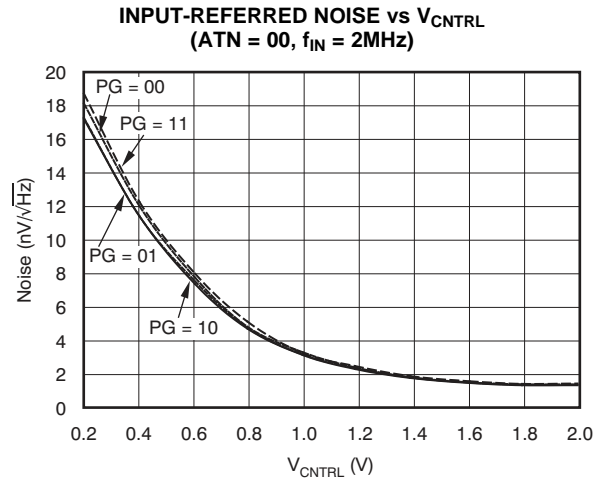

Figure 20.

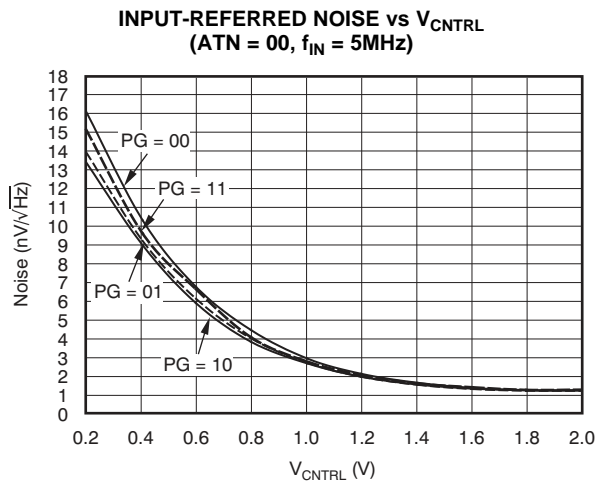

Figure 21.

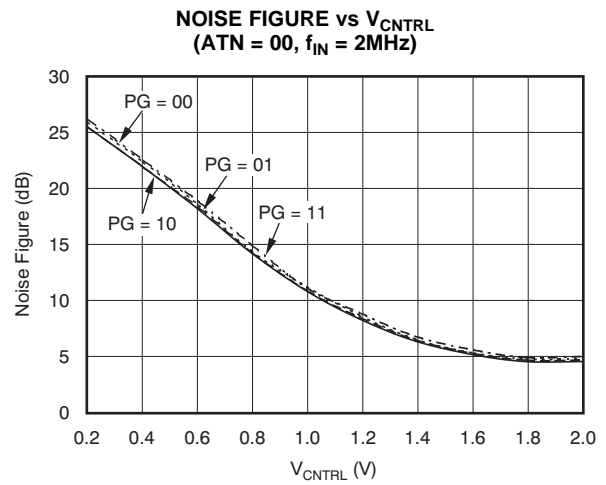

Figure 22.

**TYPICAL CHARACTERISTICS:  $AV_{DD} = DV_{DD} = 3V$  (continued)**

At  $T_A = +25^\circ C$ , load resistance =  $1k\Omega$  on each output to ground; the input to the preamp (LNA) is single-ended; pre-amp gain is fixed at  $+20dB$ ,  $f_{IN} = 2MHz$ ,  $PG = 01$ ,  $ATN = 00$ , and the output from the VCA is differential, unless otherwise noted.

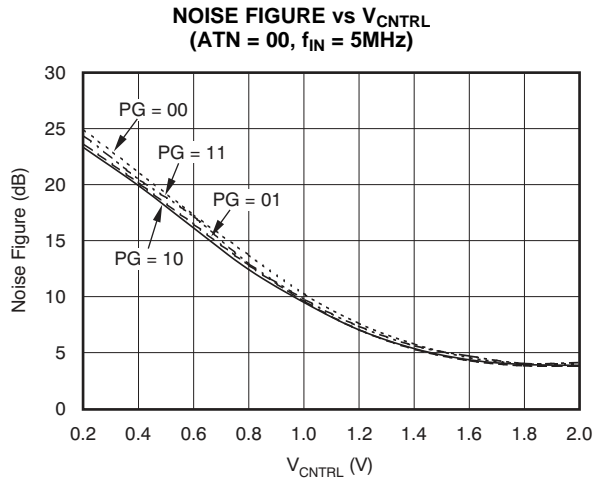

Figure 23.

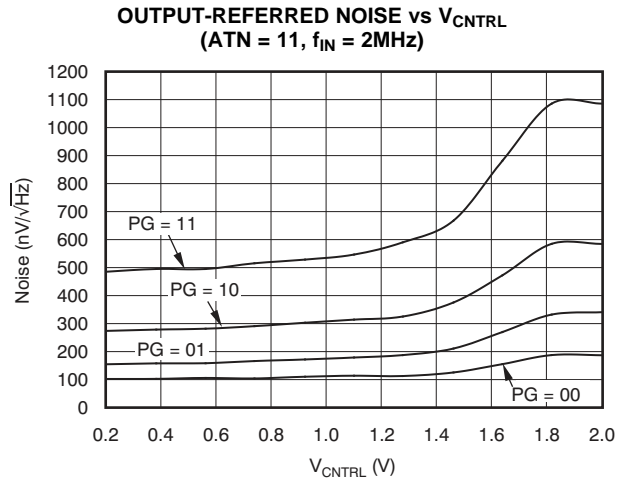

Figure 24.

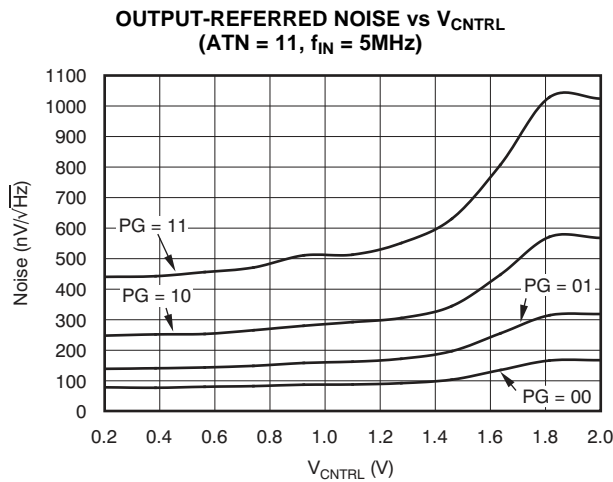

Figure 25.

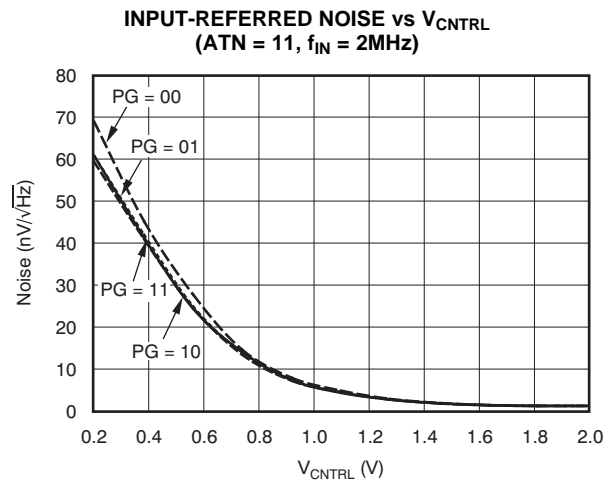

Figure 26.

**TYPICAL CHARACTERISTICS:  $AV_{DD} = DV_{DD} = 3V$  (continued)**

At  $T_A = +25^\circ C$ , load resistance =  $1k\Omega$  on each output to ground; the input to the preamp (LNA) is single-ended; pre-amp gain is fixed at  $+20dB$ ,  $f_{IN} = 2MHz$ ,  $PG = 01$ ,  $ATN = 00$ , and the output from the VCA is differential, unless otherwise noted.

**INPUT-REFERRED NOISE vs  $V_{CNTRL}$**   
( $ATN = 11$ ,  $f_{IN} = 5MHz$ )

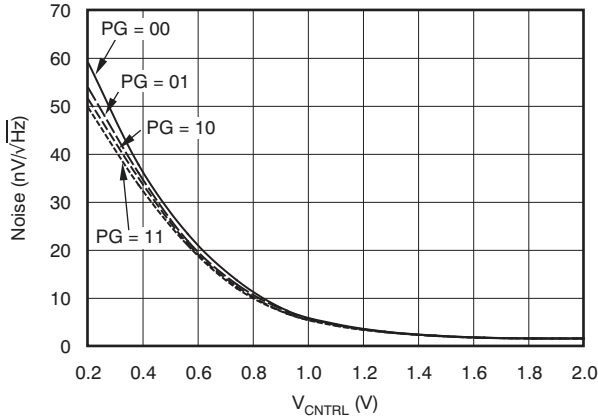

Figure 27.

**NOISE FIGURE vs  $V_{CNTRL}$**   
( $ATN = 11$ ,  $f_{IN} = 2MHz$ )

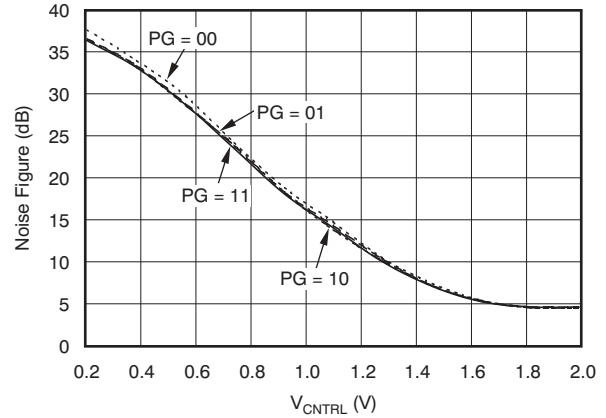

Figure 28.

**NOISE FIGURE vs  $V_{CNTRL}$**   
( $ATN = 11$ ,  $f_{IN} = 5MHz$ )

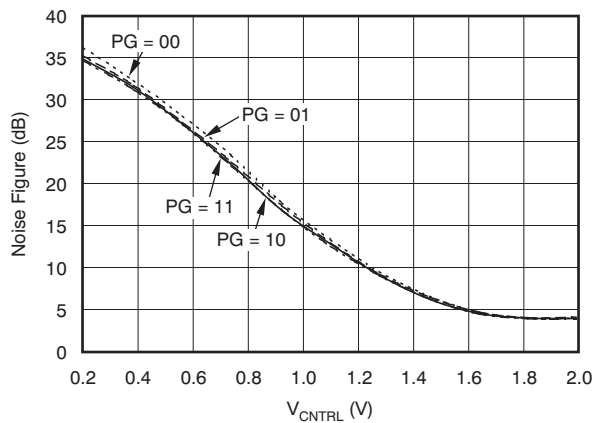

Figure 29.

**INPUT-REFERRED NOISE**  
( $2MHz$ ,  $2V V_{CNTRL}$ )

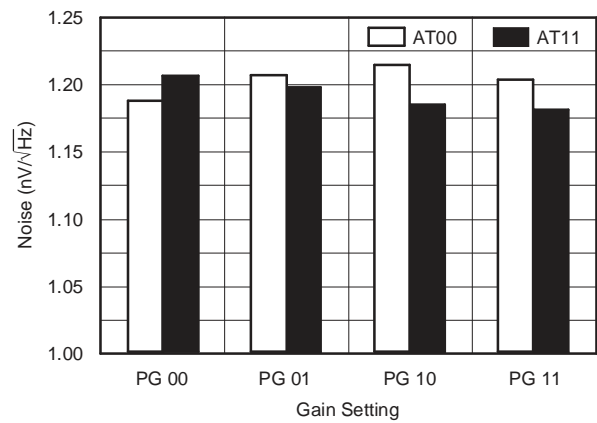

Figure 30.



**TYPICAL CHARACTERISTICS:  $AV_{DD} = DV_{DD} = 3V$  (continued)**

At  $T_A = +25^\circ C$ , load resistance =  $1k\Omega$  on each output to ground; the input to the preamp (LNA) is single-ended; pre-amp gain is fixed at  $+20dB$ ,  $f_{IN} = 2MHz$ ,  $PG = 01$ ,  $ATN = 00$ , and the output from the VCA is differential, unless otherwise noted.

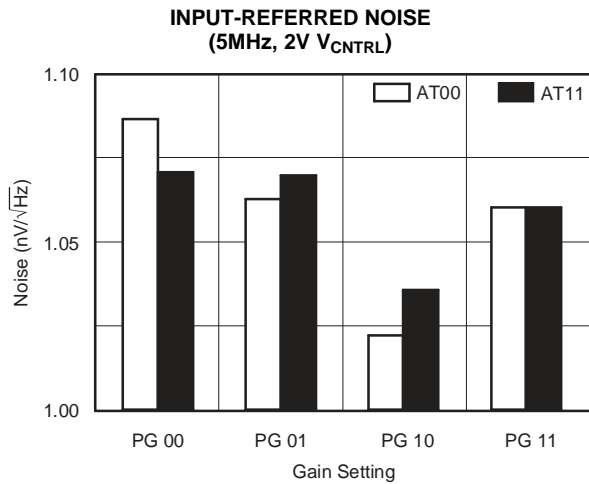

Figure 31.

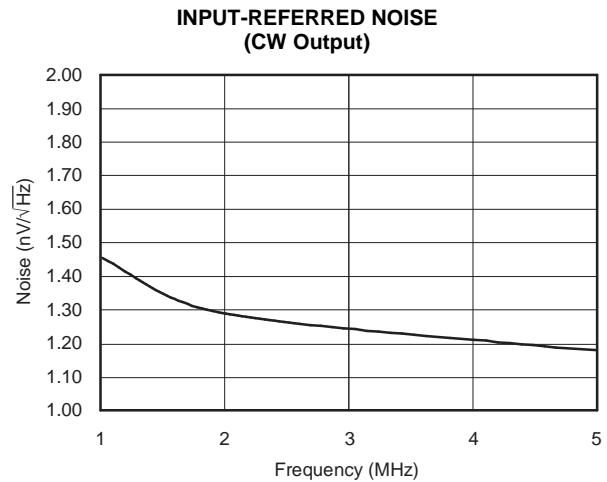

Figure 32.

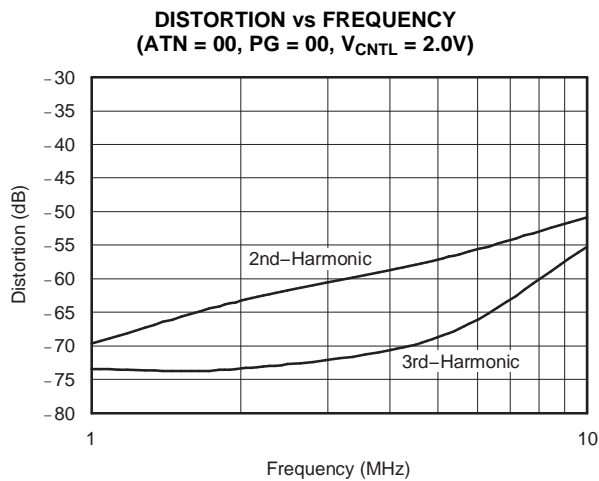

Figure 33.

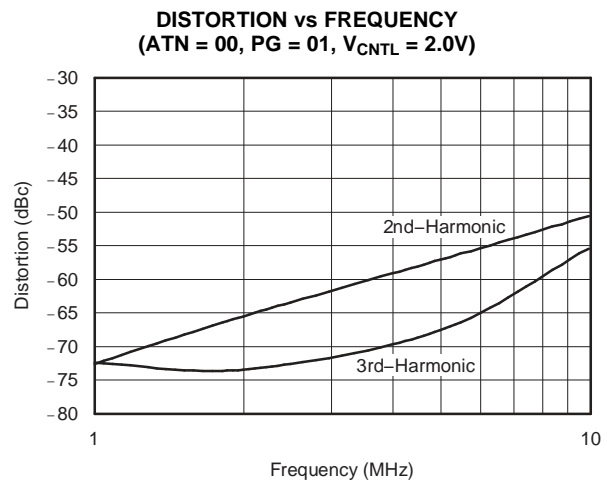

Figure 34.

**TYPICAL CHARACTERISTICS:  $AV_{DD} = DV_{DD} = 3V$  (continued)**

At  $T_A = +25^\circ C$ , load resistance =  $1k\Omega$  on each output to ground; the input to the preamp (LNA) is single-ended; pre-amp gain is fixed at  $+20dB$ ,  $f_{IN} = 2MHz$ ,  $PG = 01$ ,  $ATN = 00$ , and the output from the VCA is differential, unless otherwise noted.

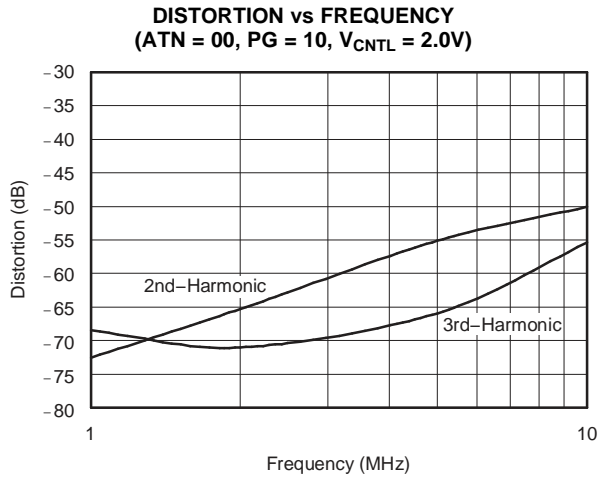

Figure 35.

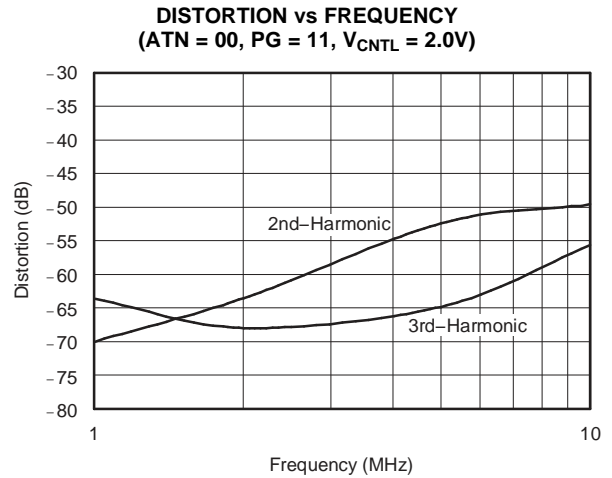

Figure 36.

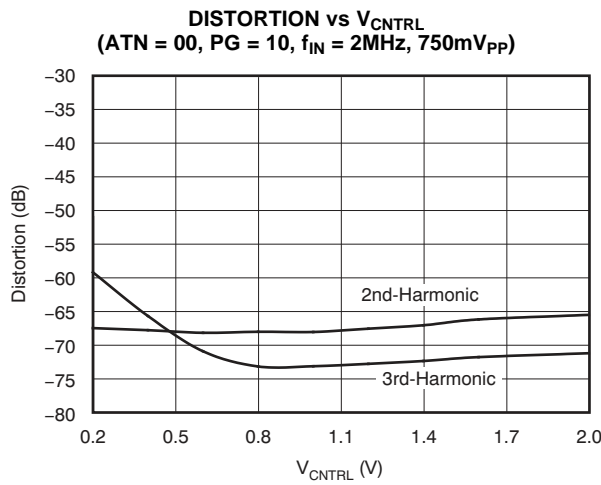

Figure 37.

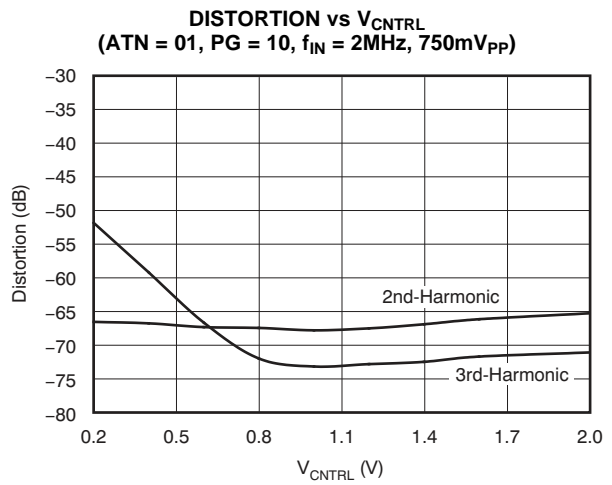

Figure 38.

**TYPICAL CHARACTERISTICS:  $AV_{DD} = DV_{DD} = 3V$  (continued)**

At  $T_A = +25^\circ C$ , load resistance =  $1k\Omega$  on each output to ground; the input to the preamp (LNA) is single-ended; pre-amp gain is fixed at  $+20dB$ ,  $f_{IN} = 2MHz$ ,  $PG = 01$ ,  $ATN = 00$ , and the output from the VCA is differential, unless otherwise noted.

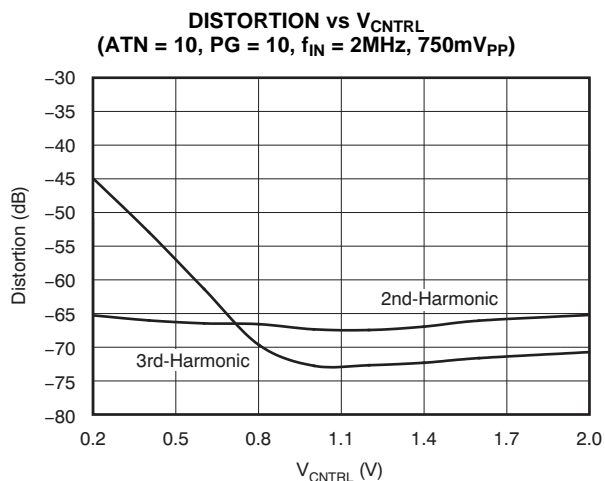

Figure 39.

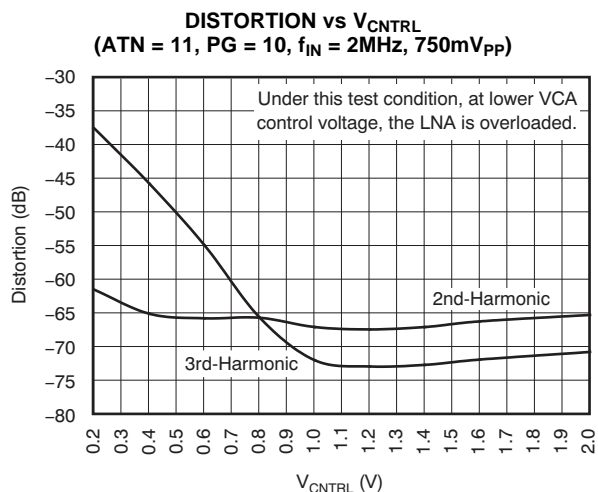

Figure 40.

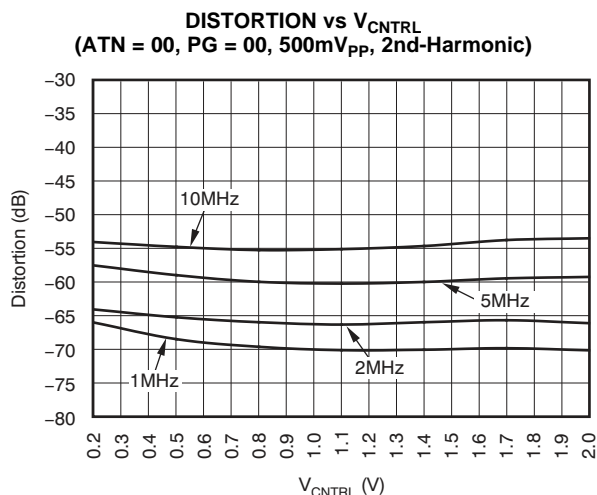

Figure 41.

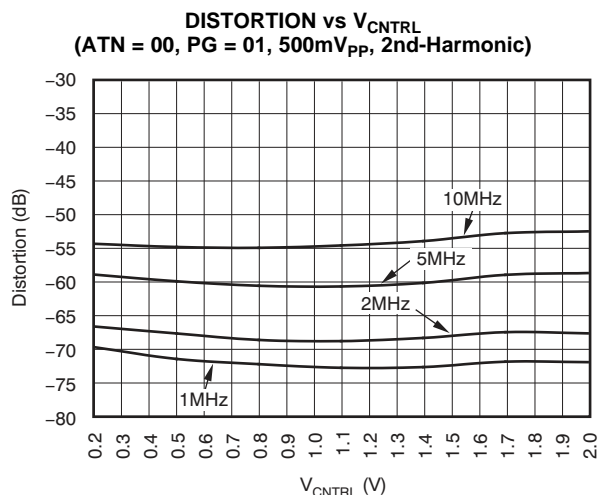

Figure 42.

**TYPICAL CHARACTERISTICS:  $AV_{DD} = DV_{DD} = 3V$  (continued)**

At  $T_A = +25^\circ C$ , load resistance =  $1k\Omega$  on each output to ground; the input to the preamp (LNA) is single-ended; pre-amp gain is fixed at  $+20dB$ ,  $f_{IN} = 2MHz$ ,  $PG = 01$ ,  $ATN = 00$ , and the output from the VCA is differential, unless otherwise noted.

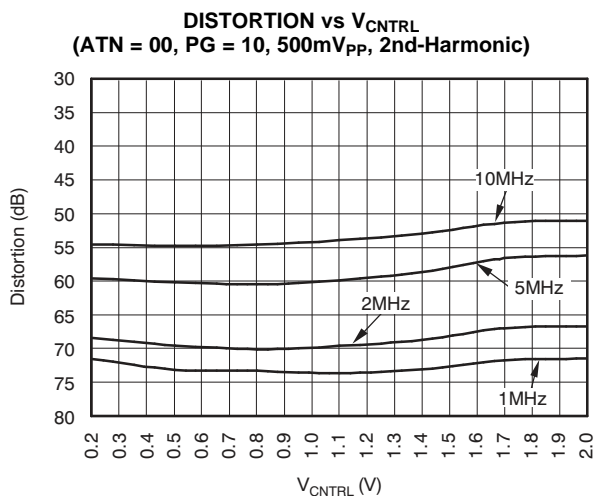

Figure 43.

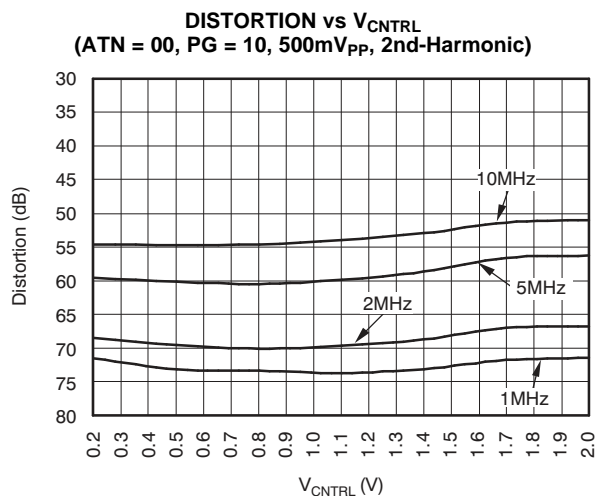

Figure 44.

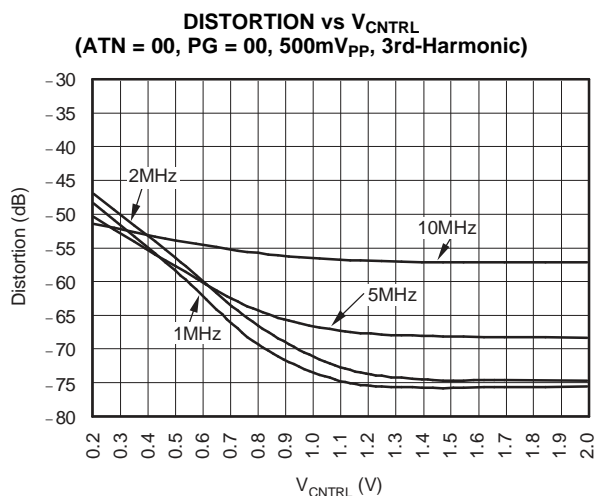

Figure 45.

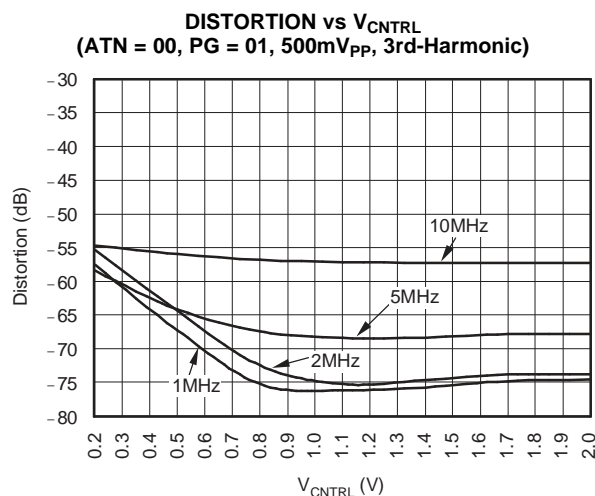

Figure 46.

**TYPICAL CHARACTERISTICS:  $AV_{DD} = DV_{DD} = 3V$  (continued)**

At  $T_A = +25^\circ C$ , load resistance =  $1k\Omega$  on each output to ground; the input to the preamp (LNA) is single-ended; pre-amp gain is fixed at  $+20dB$ ,  $f_{IN} = 2MHz$ ,  $PG = 01$ ,  $ATN = 00$ , and the output from the VCA is differential, unless otherwise noted.

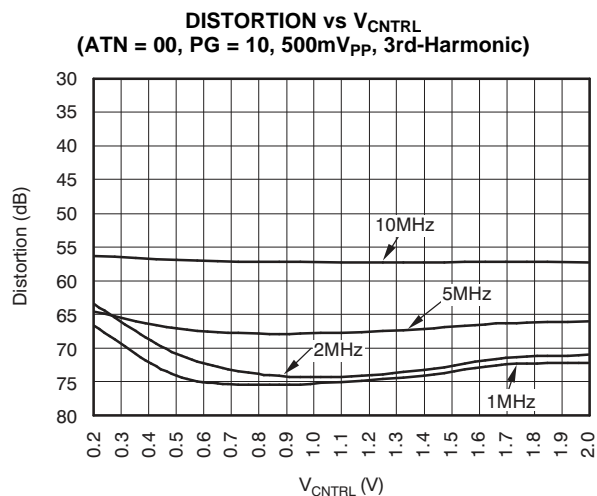

Figure 47.

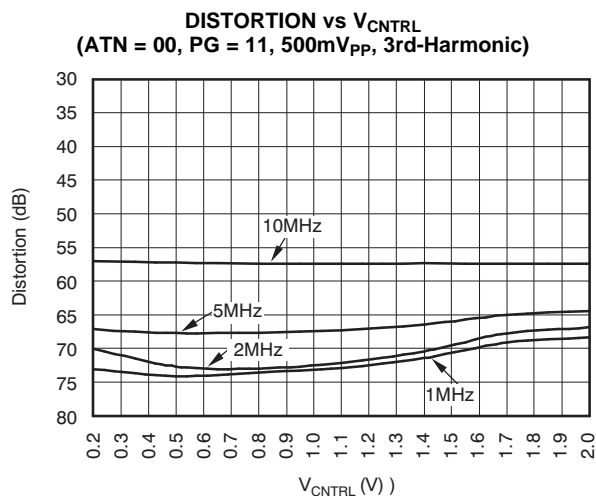

Figure 48.

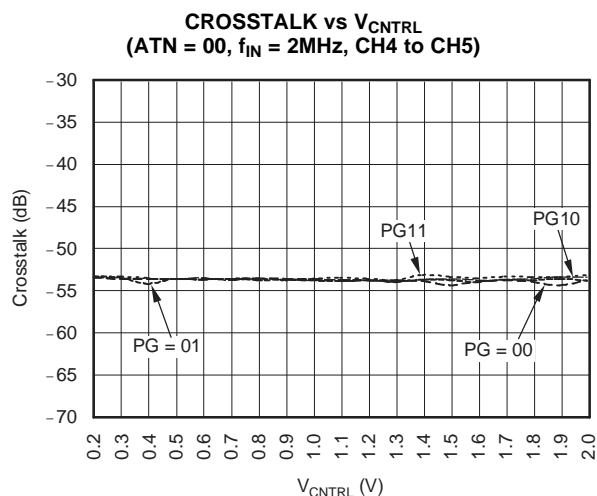

Figure 49.

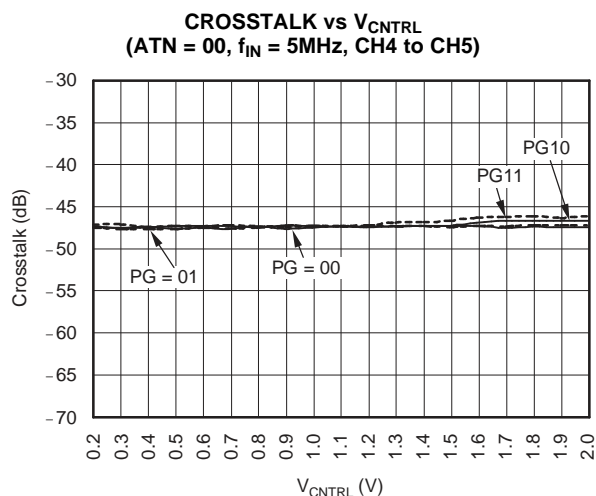

Figure 50.

**TYPICAL CHARACTERISTICS:  $AV_{DD} = DV_{DD} = 3V$  (continued)**

At  $T_A = +25^\circ C$ , load resistance =  $1k\Omega$  on each output to ground; the input to the preamp (LNA) is single-ended; pre-amp gain is fixed at  $+20dB$ ,  $f_{IN} = 2MHz$ ,  $PG = 01$ ,  $ATN = 00$ , and the output from the VCA is differential, unless otherwise noted.

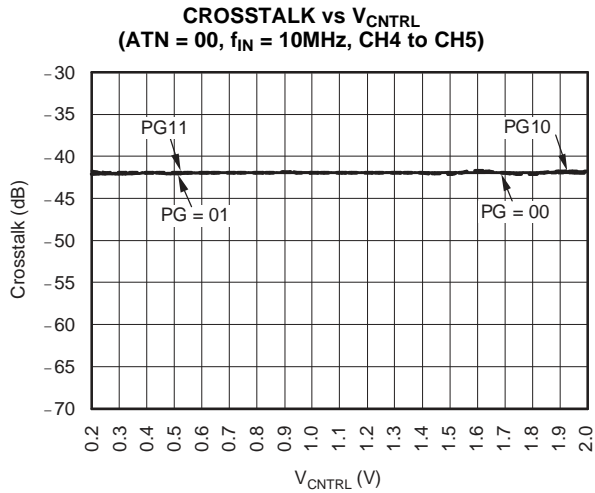

Figure 51.

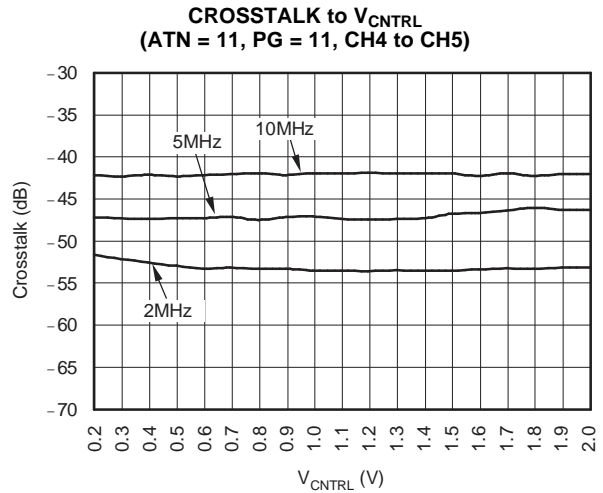

Figure 52.

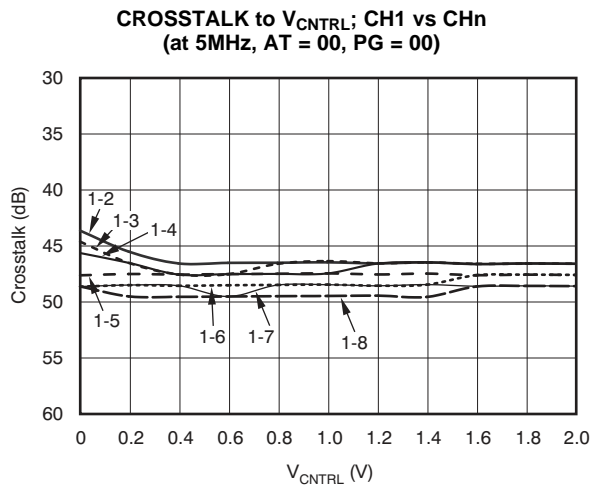

Figure 53.

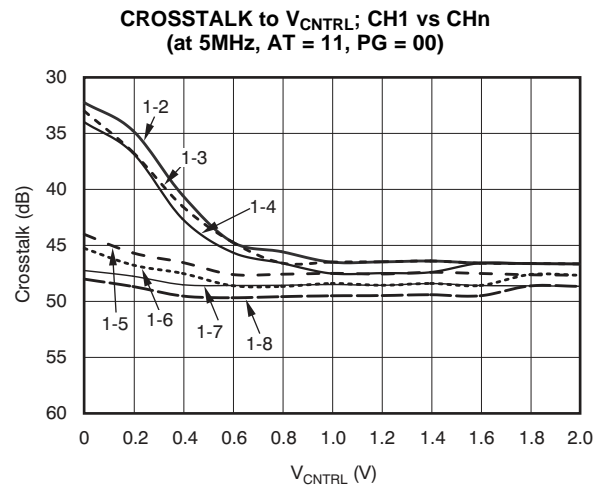
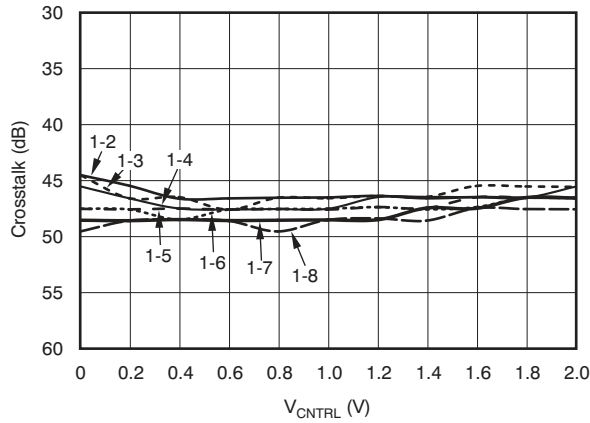

Figure 54.

**TYPICAL CHARACTERISTICS:  $AV_{DD} = DV_{DD} = 3V$  (continued)**

At  $T_A = +25^\circ C$ , load resistance =  $1k\Omega$  on each output to ground; the input to the preamp (LNA) is single-ended; pre-amp gain is fixed at  $+20dB$ ,  $f_{IN} = 2MHz$ ,  $PG = 01$ ,  $ATN = 00$ , and the output from the VCA is differential, unless otherwise noted.

**CROSTALK to  $V_{CNTRL}$ ; CH1 vs CHn  
(at 5MHz, AT = 00, PG = 11)**



**Figure 55.**

**CROSTALK to  $V_{CNTRL}$ ; CH1 vs CHn  
(at 5MHz, AT = 11, PG = 11)**

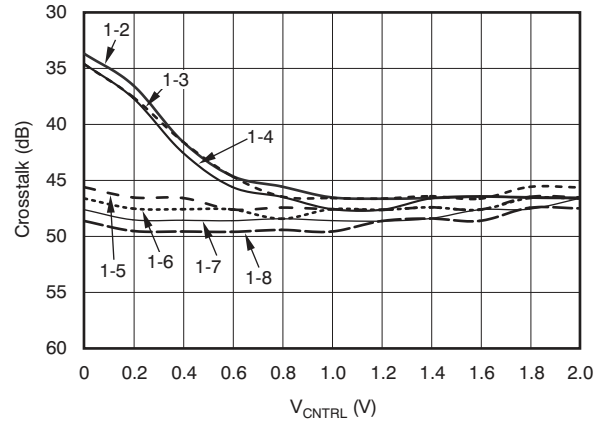

**Figure 56.**

**INPUT IMPEDANCE**

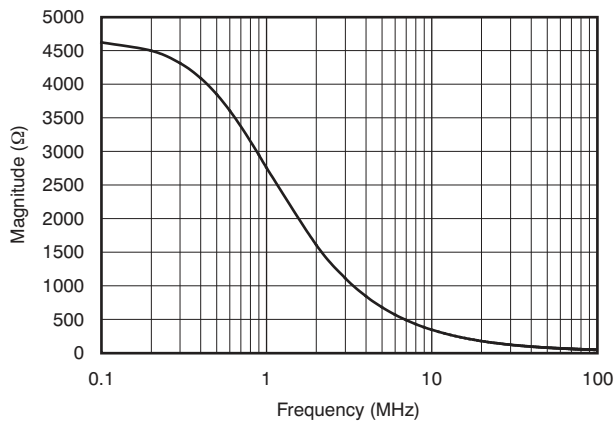

**Figure 57.**

**INPUT IMPEDANCE**

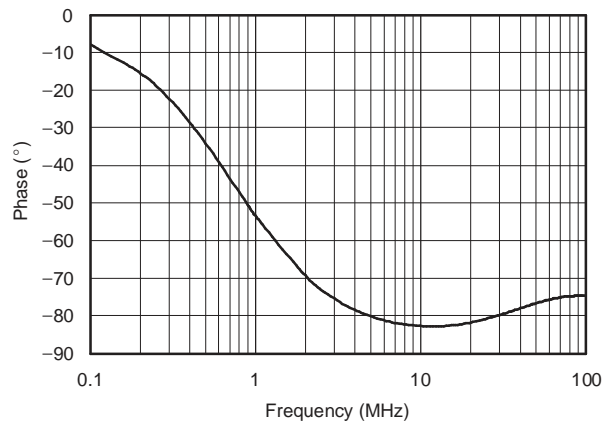

**Figure 58.**

**OVERLOAD RECOVERY vs TIME  
(ATN = 00, PG = 00,  $V_{CNTRL} = 1V$ )**

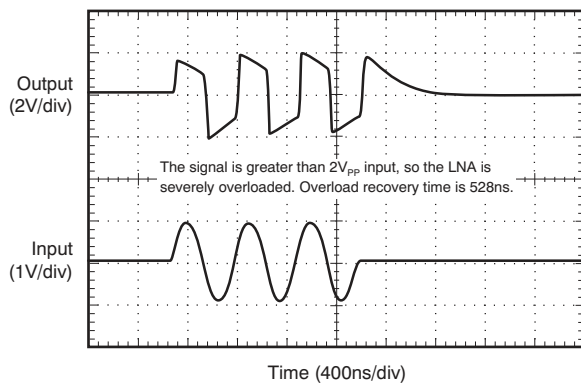

**Figure 59.**

**OVERLOAD RECOVERY vs TIME  
(ATN = 00, PG = 01,  $V_{CNTRL} = 2V$ )**

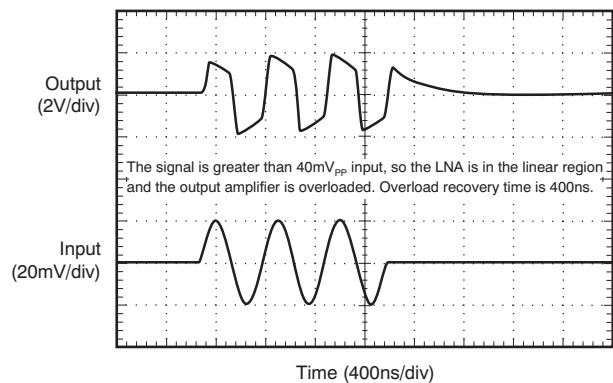

**Figure 60.**

## APPLICATION INFORMATION

**NOTE:** For current users of the VCA8613 who are switching to the VCA8617, pin 32 of the VCA8617 is a  $V_{DD}$  reference pin and requires a minimum  $0.1\mu\text{F}$  bypass capacitor to ground.

### INPUT CIRCUIT

The input of the VCA8617 integrates several commonly-used elements. Before reaching the input of the LNA, the receive signal should be coupled with a capacitor of at least  $10\text{nF}$  (preferably more). When this ac-coupling element is inserted, the LNA input bias point is held to a common-mode value of  $1.4\text{V}$  by an integrated  $4.5\text{k}\Omega$  resistor. This common-mode value changes with temperature and may also vary from chip to chip, but for each chip, it will be held constant. Two back-to-back clipping diodes are in parallel with this resistor. These diodes prevent excessive input voltages from passing through to the LNA input, preventing deep saturation effects in the LNA itself. These integrated diodes are designed to handle a dc-current of up to about  $10\text{mA}$ . If the application requires improved overload protection, external Schottky diodes, such as the BAS40 series by Infineon, should be considered.

### LOW-NOISE PRE-AMPLIFIER (LNA)

The VCA8617 integrates a low-noise pre-amplifier. Because of the high level of integration in the system, noise performance was traded for power consumption, resulting in an extremely low-power pre-amplifier, with  $0.8\text{nV}/\sqrt{\text{Hz}}$  noise performance at  $5\text{MHz}$ . The LNA is configured as a fixed-gain  $20\text{dB}$  amplifier. Of this total gain,  $6\text{dB}$  results from the single-ended to differential conversion accomplished within the LNA itself. The output of the LNA is limited

to a little over  $2V_{PP}$  differential swing. This implies a maximum input voltage swing of approximately  $200\text{mV}_{PP}$  to be operating in the linear range at  $5\text{MHz}$ . Larger input signals can be accepted by the LNA, but distortion performance will degrade with larger input signals.

### CW DOPPLER PROCESSOR

The VCA8617 integrates many of the elements necessary to allow for the implementation of a simple CW Doppler processing circuit. One circuit that was integrated was a V/I converter following the LNA, as shown in Figure 61. The V/I converter converts the differential LNA voltage output to a current, which is then passed through an  $8\times 10$  switch matrix (see Figure 62). Within this switch matrix, any of the eight LNA outputs can be connected to any of 10 CW output pins. This example is a simple current-summing circuit, such that each CW output can represent the sum of any or all the channel currents. The transconductance of the V/I converter is approximately  $20\text{mA/V}$  relative to the LNA input. For proper operation of the CW Doppler Processor, it is mandatory to have a bias voltage on the output/outputs that are selected (see Figure 63).

The CW output common-mode is  $1.4\text{V}$ .

The CW outputs are typically routed to a passive delay line, allowing coherent summing of the signals. After summing, IQ separation and down conversion to baseband precedes a pair of high-resolution, low sample rate ADCs.

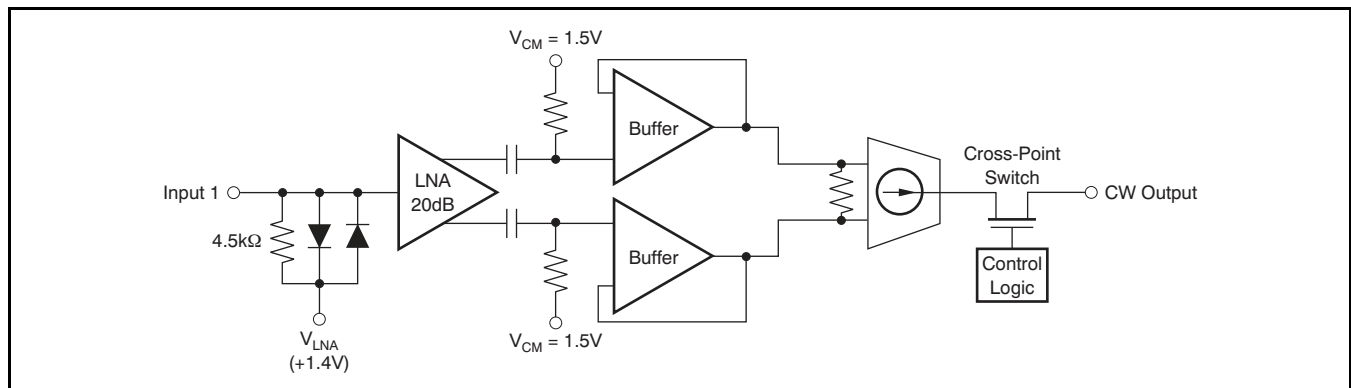

**Figure 61. Basic CW Processing Block Diagram**



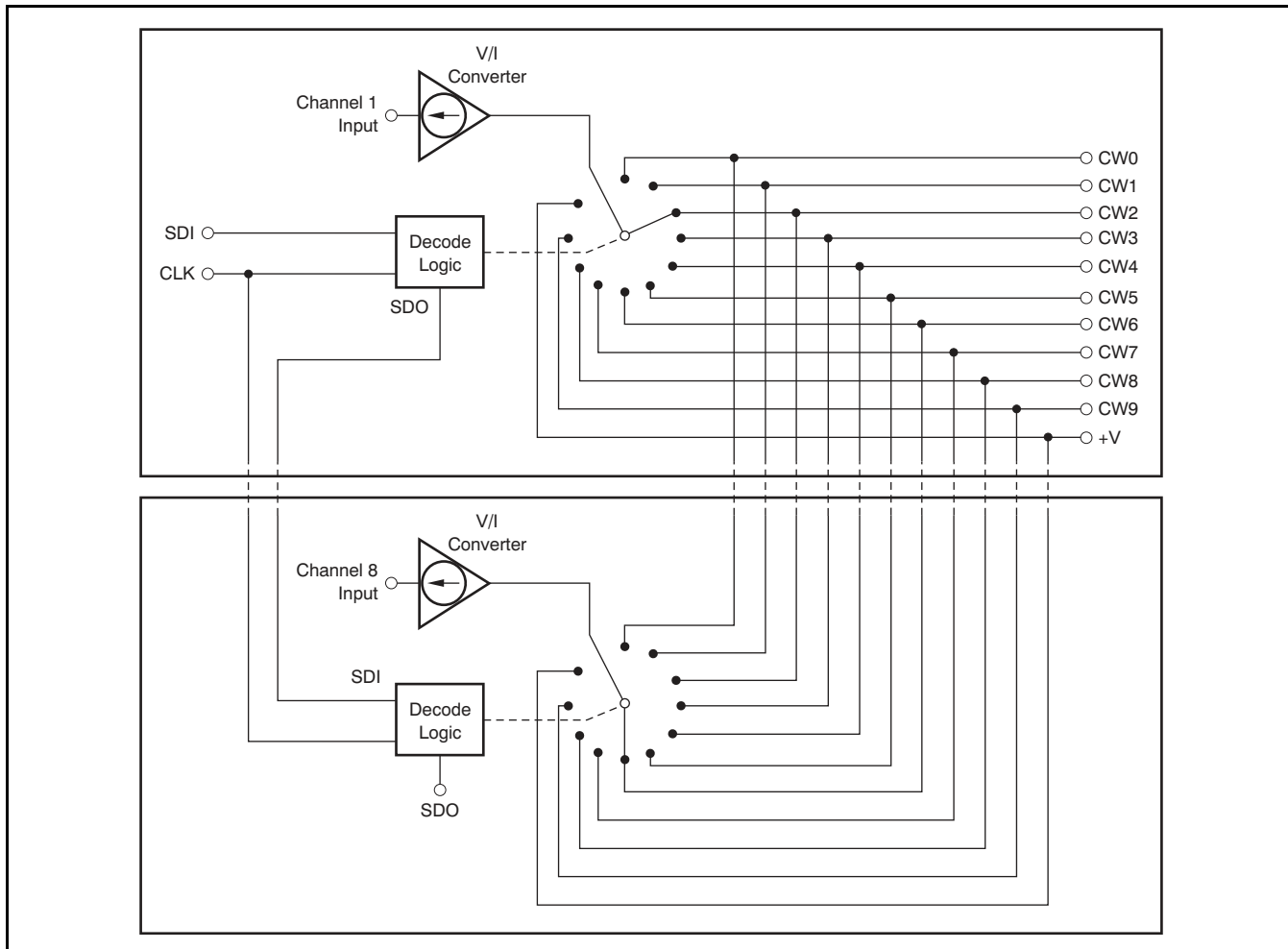

Figure 62. Basic CW Cross-Point Switch Matrix for All Eight Channels

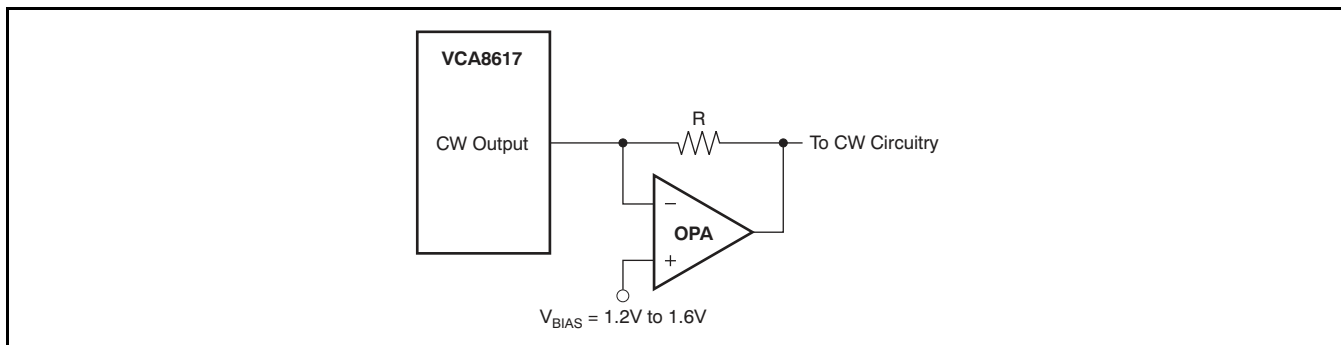

Figure 63. Operational Amplifier

## VOLTAGE-CONTROLLED ATTENUATOR (VCA)—DETAIL

The VCA is designed to have a dB-linear attenuation characteristic; that is, the gain loss in dB is constant for each equal increment of the  $V_{\text{CNTRL}}$  control voltage. Figure 64 shows a block diagram of the VCA. The attenuator is essentially a variable voltage divider consisting of one series input resistor,  $R_S$ , and 10 identical shunt FETs, placed in parallel and controlled by sequentially-activated clipping amplifiers. Each clipping amplifier can be thought of as a specialized voltage comparator with a soft transfer characteristic and well-controlled output limit voltages. The reference voltages V1 through V10 are equally spaced over the 0V to 2.0V control voltage range. As the control voltage rises through the input range of each clipping amplifier, the amplifier output will rise from 0V (FET completely ON) to  $V_{\text{CM}} - V_T$  (FET nearly OFF), where  $V_{\text{CM}}$  is the common source voltage and  $V_T$  is the threshold voltage of the FET. As each FET approaches its OFF state and the control voltage continues to rise, the next clipping amplifier/FET combination takes over for the next portion of the piecewise-linear attenuation characteristic. Thus, low control voltages have most of the FETs turned ON, while high control voltages have most turned OFF. Each FET acts to decrease the shunt resistance of the voltage divider formed by  $R_S$  and the parallel FET network.

The attenuator is comprised of two sections, with five parallel clipping amplifier/FET combinations in each. Special reference circuitry is provided so that the  $(V_{\text{CM}} - V_T)$  limit voltage will track temperature and IC process variations, minimizing the effects on the attenuator control characteristic.

In addition to the analog  $V_{\text{CNTRL}}$  gain setting input, the attenuator architecture provides digitally-programmable adjustment in four steps, via the two attenuation bits. These bits adjust the maximum achievable gain (corresponding to minimum attenuation in the VCA, with  $V_{\text{CNTRL}} = 2.0\text{V}$ ) in 5dB increments. This function is accomplished by providing multiple FET sub-elements for each of the  $Q_1$  to  $Q_{10}$  FET shunt elements (see Figure 65). In the simplified diagram of Figure 64, each shunt FET is

shown as two sub-elements,  $Q_{\text{NA}}$  and  $Q_{\text{NB}}$ . Selector switches, driven by the MGS bits, activate either or both of the sub-element FETs to adjust the maximum  $R_{\text{ON}}$  and thus achieve the stepped attenuation options.

The VCA can be used to process either differential or single-ended signals. Fully differential operation will reduce 2nd-harmonic distortion by about 10dB for full-scale signals.

Input impedance of the VCA varies with gain setting, because of the changing resistances of the programmable voltage divider structure. At large attenuation factors (that is, low gain settings), the impedance will approach the series resistor value of approximately 120Ω.

As with the LNA stage, the VCA output is ac-coupled into the PGA. This ac-coupling means that the attenuation-dependent dc common-mode voltage will not propagate into the PGA, and so the PGA dc output level will remain constant.

Finally, note that the  $V_{\text{CNTRL}}$  input consists of FET gate inputs. This architecture provides very high impedance and ensures that multiple VCA8617 devices may be connected in parallel with no significant loading effects. The nominal voltage range for the  $V_{\text{CNTRL}}$  input spans from 0V to 2.0V. Overdriving this input (greater than 3V) does not affect the performance.

## PGA POST-AMPLIFIER

See Figure 66 for a simplified circuit diagram of the PGA. PGA gain is programmed through the serial port, and can be configured to 24 different gain settings of 25dB, 30dB, 35dB, and 40dB, as shown in Table 9. A patented circuit has been implemented in the PGA that allows for exceptional overload signal recovery.

**Table 9. PGA Gain Settings**

PG1, PG0	GAIN
0, 0	25dB
0, 1	30dB
1, 0	35dB
1, 1	40dB

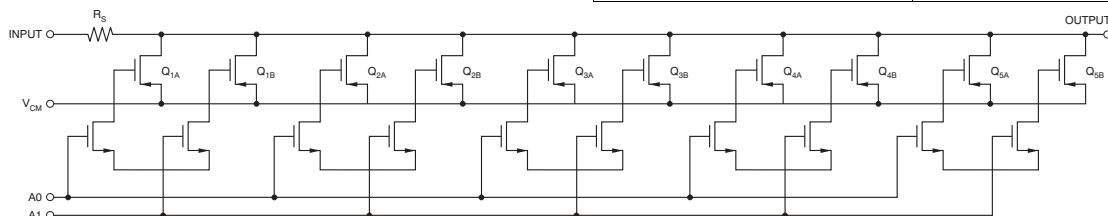

**Figure 64. Programmable Attenuator Section**

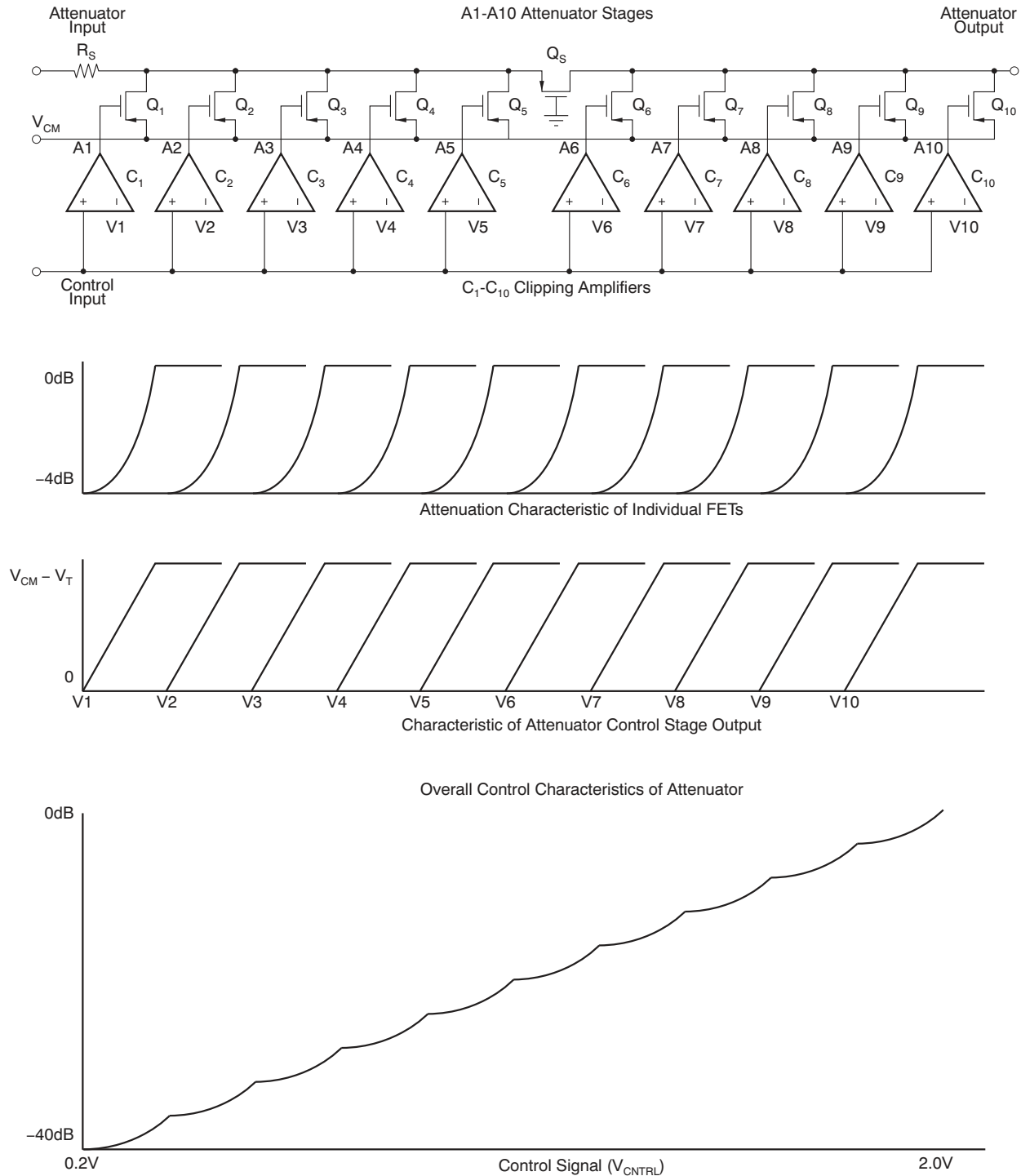

Figure 65. Piecewise Approximation to Logarithmic Control Characteristics

## OUTPUT FILTER

The VCA8617 integrates an almost three-pole, 15MHz low-pass Butterworth filter in the output stage. The cutoff frequency is implemented with passive semiconductor elements and as such, the cutoff frequency will not be precise. The output pins of the VCA8617, as shown in [Figure 66](#), nominally sit at approximately  $1.5V_{DC}$ . However, this dc voltage varies slightly over PG gain settings as well as from chip to chip as a result of process variations. For users who cannot tolerate this slight variation, an ac coupling capacitor is recommended between the VCA outputs and the ADC inputs. The smaller the value of this capacitor, the better, because it reduces the pulse signal settling time. For the typical performance charts in this data sheet, a 560pF capacitor was used.

## SERIAL INTERFACE

The serial interface of the VCA8617 allows flexibility in the use of the part. The following parameters are set from the serial control registers:

- Mode
  - TGC mode
  - CW mode
- Attenuation range
- PGA gain
- Power-down (this is the default state in which the VCA8617 initializes)
- CW output selection for each input channel

The serial interface uses an SPI™ style of interface format. The [Input Register Bit Maps](#) show the functionality of each control register.

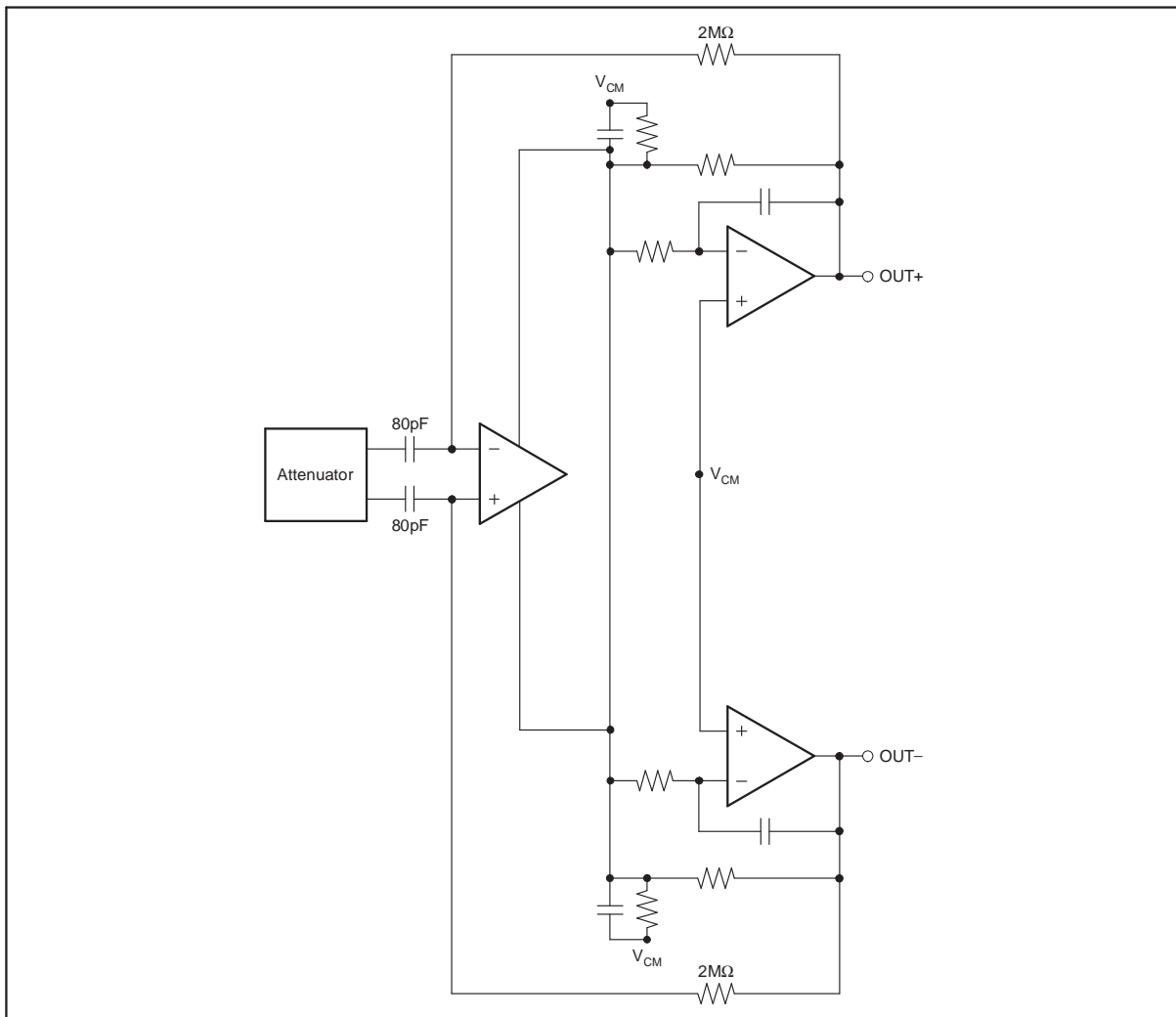

**Figure 66. Simplified PGA and Output Filter Circuit**

**LAYOUT CONSIDERATIONS**

The VCA8617 is a multi-channel amplifier with integrated digital controls, capable of high gains. Layout of the VCA8617 is fairly straightforward. By connecting all of the grounds (including the digital grounds) to the analog ground, noise performance can be maintained.

The analog ground should be a solid plane.

Power-supply decoupling and decoupling of the control voltage ( $V_{CNTRL}$ ) pin are essential in order to ensure that the noise performance be maintained. For further help in determining basic values, refer to [Figure 67](#).

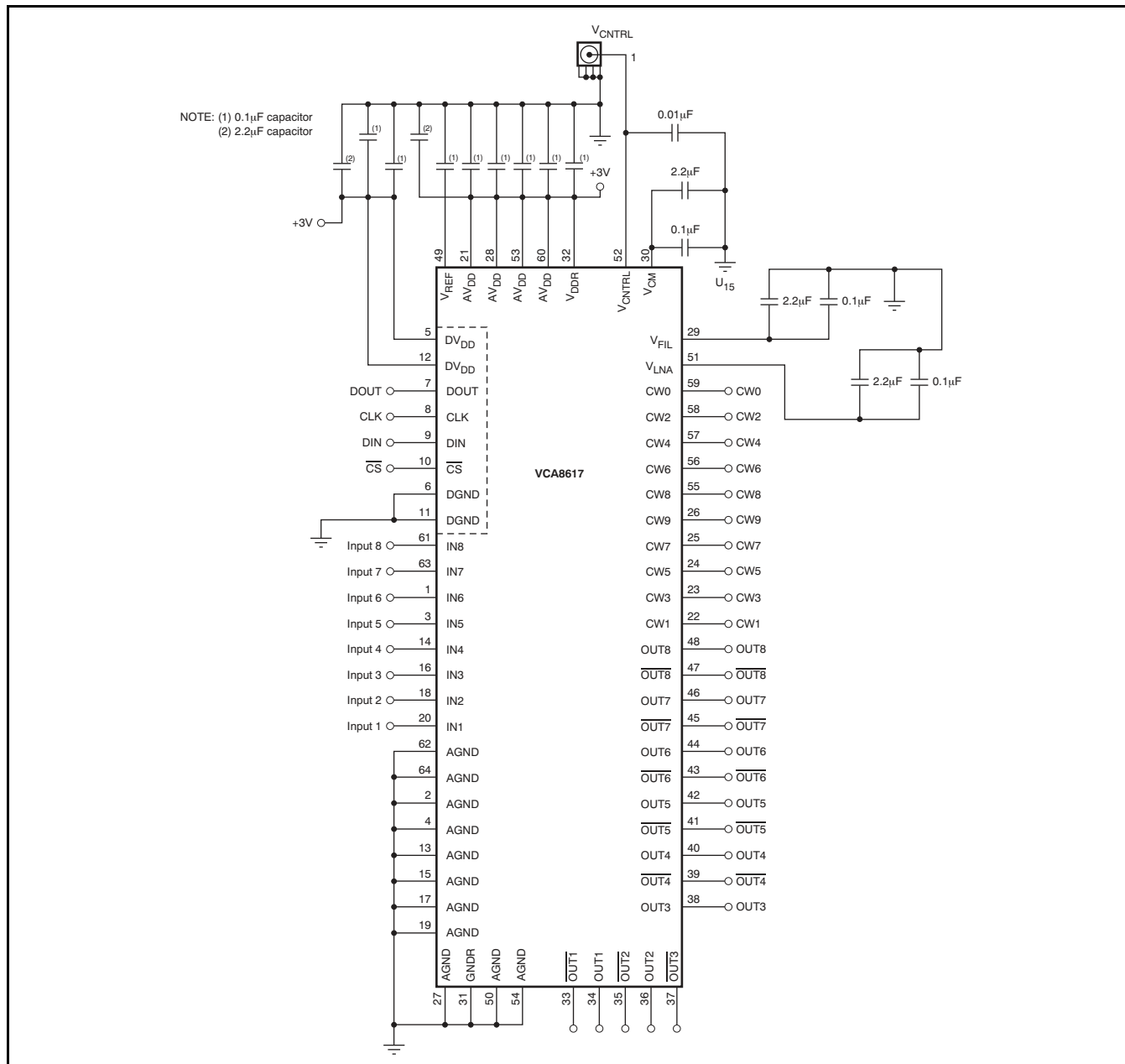

**Figure 67. Basic Connection Diagram**

## REVISION HISTORY

NOTE: Page numbers for previous revisions may differ from page numbers in the current version.

<b>Changes from Revision E (November, 2007) to Revision F</b>		<b>Page</b>
• Corrected y-axis labels for <a href="#">Figure 59</a> .....		23
• Corrected y-axis labels for <a href="#">Figure 60</a> .....		23
<b>Changes from Revision D (May, 2005) to Revision E</b>		<b>Page</b>
• Changed "100mW/channel" feature to "103mW/channel" .....		1
• Changed Electrical Characteristics measured voltage; included $DV_{DD}$ .....		3
• Added Input Common-Mode Voltage specification .....		3
• Changed Input Voltage Range typical specification from 20V to 2.0V .....		3
• Changed Electrical Characteristics measured voltage; included $DV_{DD}$ .....		4
• Replaced Figure 22 .....		14
• Replaced Figure 23 .....		15
• Replaced Figure 28 .....		16
• Replaced Figure 29 .....		16
• Replaced Figure 43 .....		20
• Replaced Figure 44 .....		20
• Replaced Figure 47 .....		21
• Replaced Figure 48 .....		21
• Revised Application Information Section .....		24

**PACKAGING INFORMATION**

Orderable Device	Status (1)	Package Type	Package Drawing	Pins	Package Qty	Eco Plan (2)	Lead finish/ Ball material (6)	MSL Peak Temp (3)	Op Temp (°C)	Device Marking (4/5)	Samples
VCA8617PAGR	ACTIVE	TQFP	PAG	64	1500	RoHS & Green	NIPDAU	Level-4-260C-72 HR	-40 to 85	VCA8617	<a href="#">Samples</a>
VCA8617PAGT	ACTIVE	TQFP	PAG	64	250	RoHS & Green	NIPDAU	Level-4-260C-72 HR	-40 to 85	VCA8617	<a href="#">Samples</a>

(1) The marketing status values are defined as follows:

**ACTIVE:** Product device recommended for new designs.

**LIFEBUY:** TI has announced that the device will be discontinued, and a lifetime-buy period is in effect.

**NRND:** Not recommended for new designs. Device is in production to support existing customers, but TI does not recommend using this part in a new design.

**PREVIEW:** Device has been announced but is not in production. Samples may or may not be available.

**OBSELETE:** TI has discontinued the production of the device.

(2) **RoHS:** TI defines "RoHS" to mean semiconductor products that are compliant with the current EU RoHS requirements for all 10 RoHS substances, including the requirement that RoHS substance do not exceed 0.1% by weight in homogeneous materials. Where designed to be soldered at high temperatures, "RoHS" products are suitable for use in specified lead-free processes. TI may reference these types of products as "Pb-Free".

**RoHS Exempt:** TI defines "RoHS Exempt" to mean products that contain lead but are compliant with EU RoHS pursuant to a specific EU RoHS exemption.

**Green:** TI defines "Green" to mean the content of Chlorine (Cl) and Bromine (Br) based flame retardants meet JS709B low halogen requirements of <=1000ppm threshold. Antimony trioxide based flame retardants must also meet the <=1000ppm threshold requirement.

(3) MSL, Peak Temp. - The Moisture Sensitivity Level rating according to the JEDEC industry standard classifications, and peak solder temperature.

(4) There may be additional marking, which relates to the logo, the lot trace code information, or the environmental category on the device.

(5) Multiple Device Markings will be inside parentheses. Only one Device Marking contained in parentheses and separated by a "~" will appear on a device. If a line is indented then it is a continuation of the previous line and the two combined represent the entire Device Marking for that device.

(6) Lead finish/Ball material - Orderable Devices may have multiple material finish options. Finish options are separated by a vertical ruled line. Lead finish/Ball material values may wrap to two lines if the finish value exceeds the maximum column width.

**Important Information and Disclaimer:**The information provided on this page represents TI's knowledge and belief as of the date that it is provided. TI bases its knowledge and belief on information provided by third parties, and makes no representation or warranty as to the accuracy of such information. Efforts are underway to better integrate information from third parties. TI has taken and continues to take reasonable steps to provide representative and accurate information but may not have conducted destructive testing or chemical analysis on incoming materials and chemicals. TI and TI suppliers consider certain information to be proprietary, and thus CAS numbers and other limited information may not be available for release.

In no event shall TI's liability arising out of such information exceed the total purchase price of the TI part(s) at issue in this document sold by TI to Customer on an annual basis.





PAG (S-PQFP-G64)

PLASTIC QUAD FLATPACK

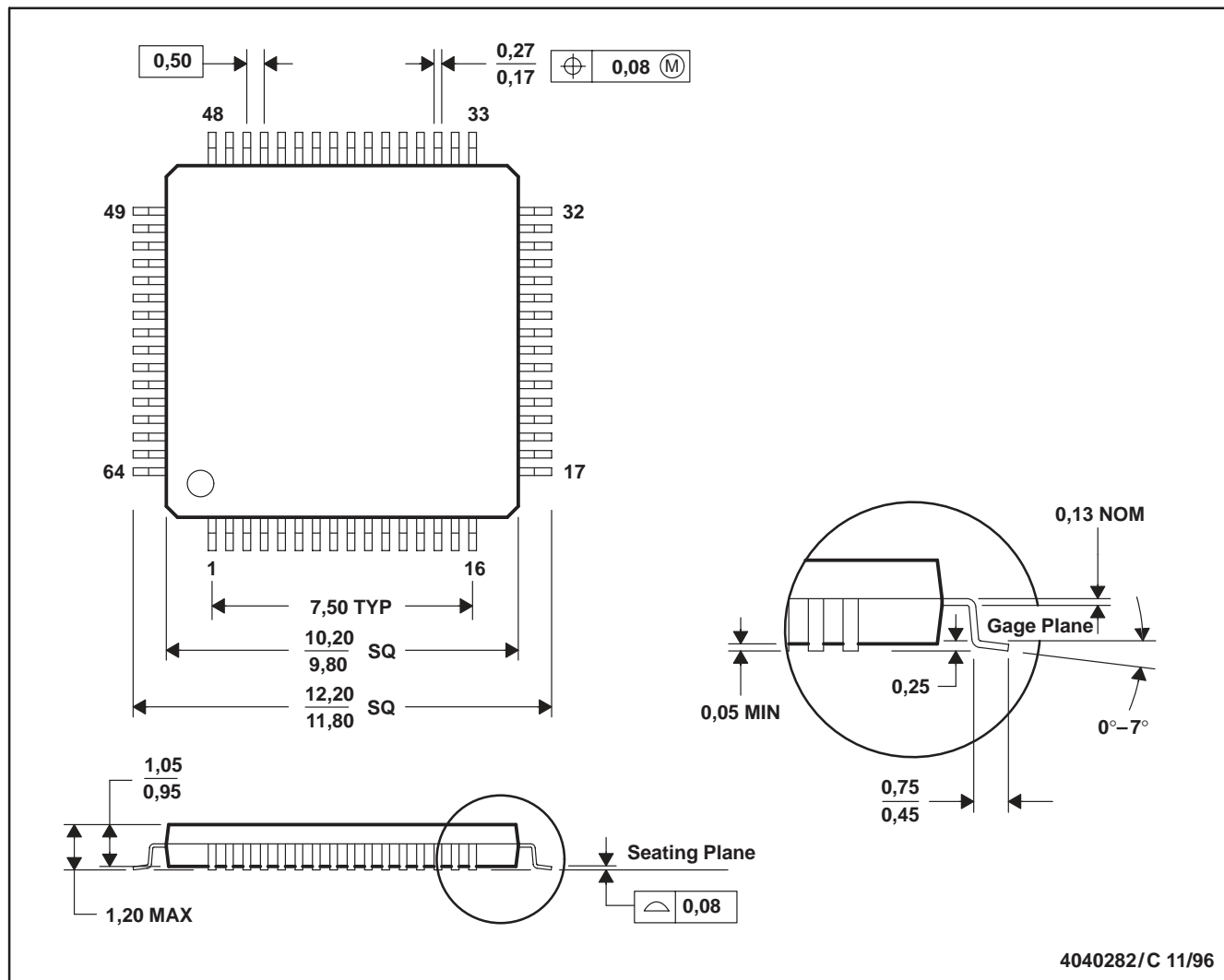

4040282/C 11/96

- NOTES: A. All linear dimensions are in millimeters.  
 B. This drawing is subject to change without notice.  
 C. Falls within JEDEC MS-026

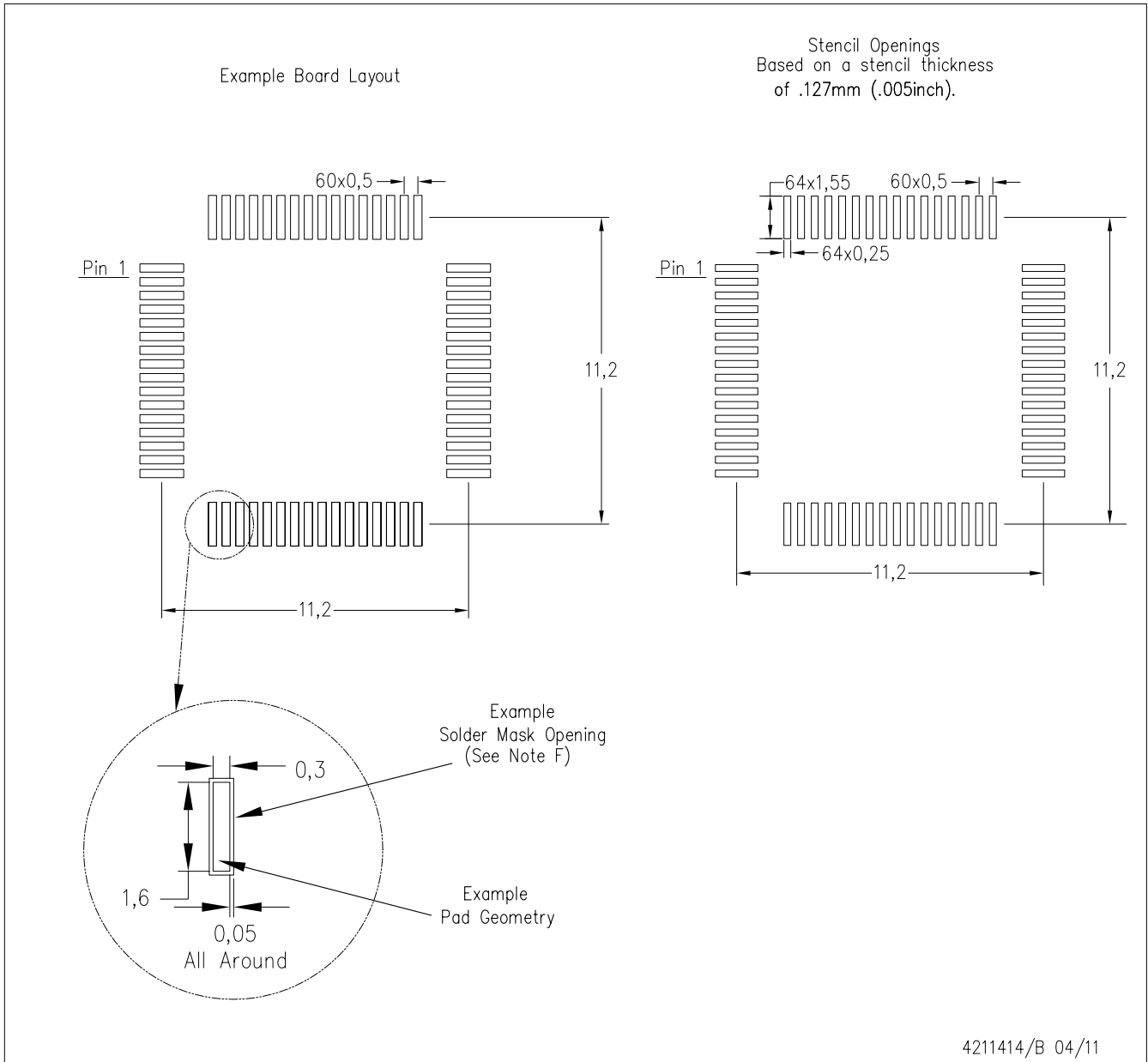

- NOTES:
- A. All linear dimensions are in millimeters.
  - B. This drawing is subject to change without notice.
  - C. Laser cutting apertures with trapezoidal walls and also rounding corners will offer better paste release. Customers should contact their board assembly site for stencil design recommendations. Example stencil design based on a 50% volumetric metal load solder paste. Refer to IPC-7525 for other stencil recommendations.
  - D. Customers should contact their board fabrication site for solder mask tolerances between and around signal pads.

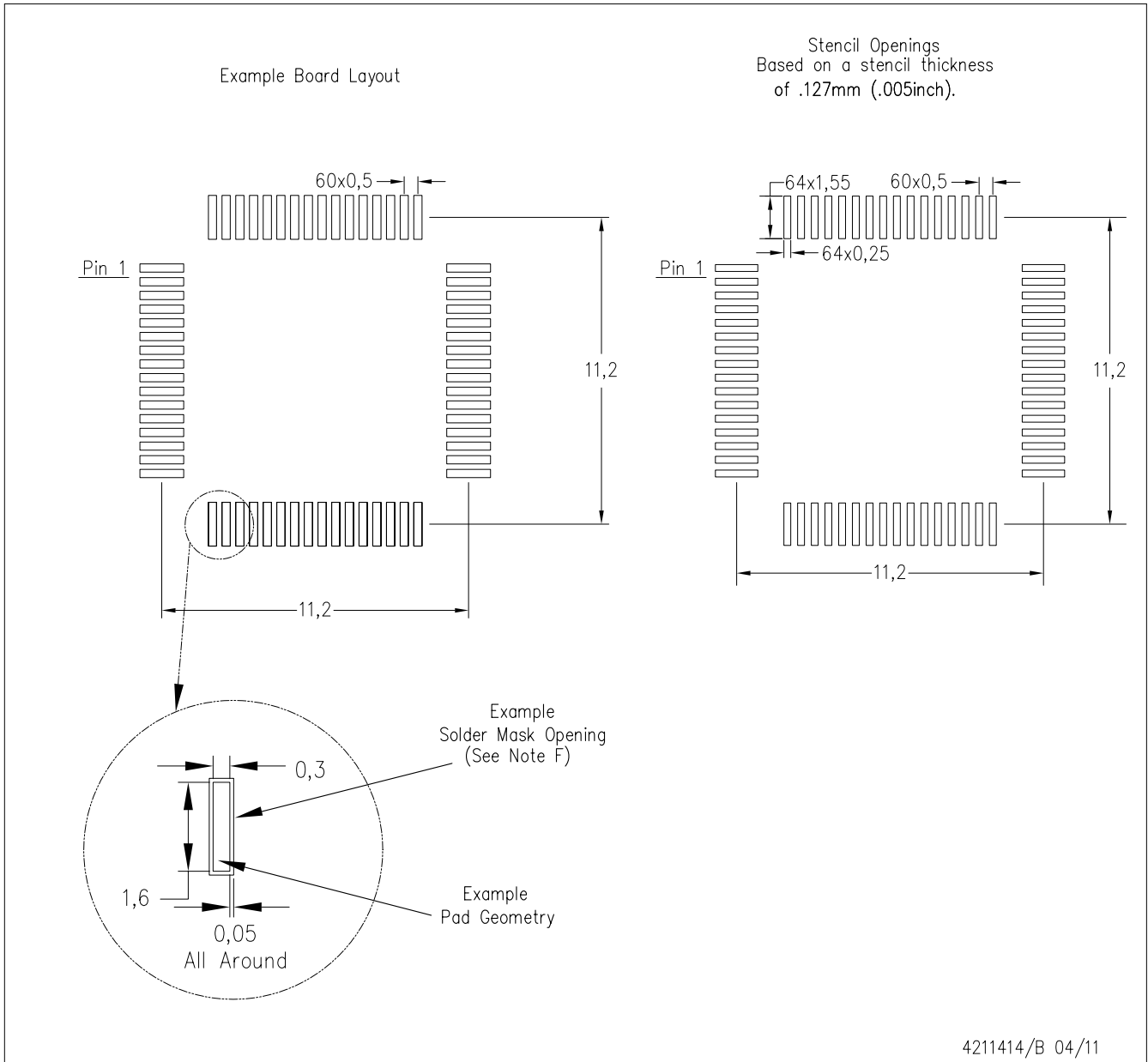

- NOTES:
- A. All linear dimensions are in millimeters.
  - B. This drawing is subject to change without notice.
  - C. Laser cutting apertures with trapezoidal walls and also rounding corners will offer better paste release. Customers should contact their board assembly site for stencil design recommendations. Example stencil design based on a 50% volumetric metal load solder paste. Refer to IPC-7525 for other stencil recommendations.
  - D. Customers should contact their board fabrication site for solder mask tolerances between and around signal pads.

## IMPORTANT NOTICE AND DISCLAIMER

TI PROVIDES TECHNICAL AND RELIABILITY DATA (INCLUDING DATASHEETS), DESIGN RESOURCES (INCLUDING REFERENCE DESIGNS), APPLICATION OR OTHER DESIGN ADVICE, WEB TOOLS, SAFETY INFORMATION, AND OTHER RESOURCES "AS IS" AND WITH ALL FAULTS, AND DISCLAIMS ALL WARRANTIES, EXPRESS AND IMPLIED, INCLUDING WITHOUT LIMITATION ANY IMPLIED WARRANTIES OF MERCHANTABILITY, FITNESS FOR A PARTICULAR PURPOSE OR NON-INFRINGEMENT OF THIRD PARTY INTELLECTUAL PROPERTY RIGHTS.

These resources are intended for skilled developers designing with TI products. You are solely responsible for (1) selecting the appropriate TI products for your application, (2) designing, validating and testing your application, and (3) ensuring your application meets applicable standards, and any other safety, security, or other requirements. These resources are subject to change without notice. TI grants you permission to use these resources only for development of an application that uses the TI products described in the resource. Other reproduction and display of these resources is prohibited. No license is granted to any other TI intellectual property right or to any third party intellectual property right. TI disclaims responsibility for, and you will fully indemnify TI and its representatives against, any claims, damages, costs, losses, and liabilities arising out of your use of these resources.

TI's products are provided subject to TI's Terms of Sale ([www.ti.com/legal/termsofsale.html](http://www.ti.com/legal/termsofsale.html)) or other applicable terms available either on [ti.com](http://ti.com) or provided in conjunction with such TI products. TI's provision of these resources does not expand or otherwise alter TI's applicable warranties or warranty disclaimers for TI products.

Mailing Address: Texas Instruments, Post Office Box 655303, Dallas, Texas 75265  
Copyright © 2020, Texas Instruments Incorporated