



MZC1-2V2NS-KP0

MZC1

SENSORS FOR C-SLOT CYLINDERS

SICK
Sensor Intelligence.



Ordering information

| Type | Part no. |
|----------------|----------|
| MZC1-2V2NS-KP0 | 1059744 |

Other models and accessories → www.sick.com/MZC1



Detailed technical data

Features

| | |
|------------------------------------|---|
| Cylinder type | C-slot |
| Cylinder types with adapter | SMC rail CDQ2 SMC rail ECDQ2 Round body cylinder Profile cylinders and tie-rod cylinders |
| Housing length | 23.7 mm |
| Switching output | NPN |
| Switching frequency | 1,000 Hz |
| Output function | NO |
| Electrical wiring | DC 3-wire |
| Enclosure rating | IP68 ¹⁾ |

¹⁾ According to EN 60529 (IP 67 / IP 68).

Mechanics/electronics

| | |
|---|------------------------|
| Supply voltage | 10 V DC ... 30 V DC |
| Power consumption | 8 mA, without load |
| Voltage drop | ≤ 2.5 V |
| Continuous current I_a | ≤ 100 mA |
| Protection class | III |
| Response sensitivity, typ. | 2.2 mT |
| Overrun distance, typ. | 4 mm |
| Hysteresis, typ. | ≤ 0.8 mT |
| Reproducibility | ≤ 0.1 mT ¹⁾ |
| Reverse polarity protection | Yes |
| Short-circuit protection | Yes |
| Power-up pulse protection | Yes |

¹⁾ U_b and T_a constant.

| | |
|---------------------------------------|---|
| Ambient operating temperature | -30 °C ... +80 °C |
| Shock and vibration resistance | 30 g, 11 ms / 10 ... 55 Hz, 1 mm |
| EMC | According to EN 60947-5-2 |
| Connection type | Cable with connector M8, 3-pin, drag chain use, 0.3 m |
| Connection type Detail | |
| Conductor cross section | 0.09 mm ² |
| Cable diameter | Ø 2.2 mm |
| Bending radius | With fixed installation > 2 x cable diameter For flexible use > 5 x cable diameter |
| Torsion force | ± 270° / 0.1 m |
| Torsion cycles | 300,000 |
| Drag chain cycles | 5,000,000 |
| Drag chain parameters | Traversing speed max. 3 m/s Acceleration max. 10 m/s ² Bending cycles in the drag chain min. 5 million |
| Cable outlet | Axial |
| Material | |
| Housing | Plastic |
| Cable | PUR |
| UL File No. | NRKH.E181493 & NRKH7.E181493 |

¹⁾ Ub and Ta constant.

Safety-related parameters

| | |
|-------------------------------------|-------------|
| MTTF_D | 2,461 years |
| DC_{avg} | 0 % |
| T_M (mission time) | 20 years |

Classifications

| | |
|-----------------------|----------|
| eCl@ss 5.0 | 27270104 |
| eCl@ss 5.1.4 | 27270104 |
| eCl@ss 6.0 | 27270104 |
| eCl@ss 6.2 | 27270104 |
| eCl@ss 7.0 | 27270104 |
| eCl@ss 8.0 | 27270104 |
| eCl@ss 8.1 | 27270104 |
| eCl@ss 9.0 | 27270104 |
| eCl@ss 10.0 | 27270104 |
| eCl@ss 11.0 | 27270104 |
| eCl@ss 12.0 | 27274301 |
| ETIM 5.0 | EC002544 |
| ETIM 6.0 | EC002544 |
| ETIM 7.0 | EC002544 |
| ETIM 8.0 | EC002544 |
| UNSPSC 16.0901 | 39122230 |

Installation note

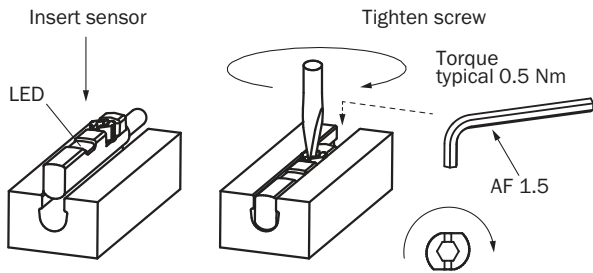

Connection diagram

Cd-002

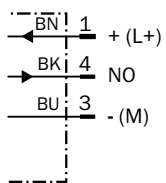

Dimensional drawing (Dimensions in mm (inch))

Cable with connector M8

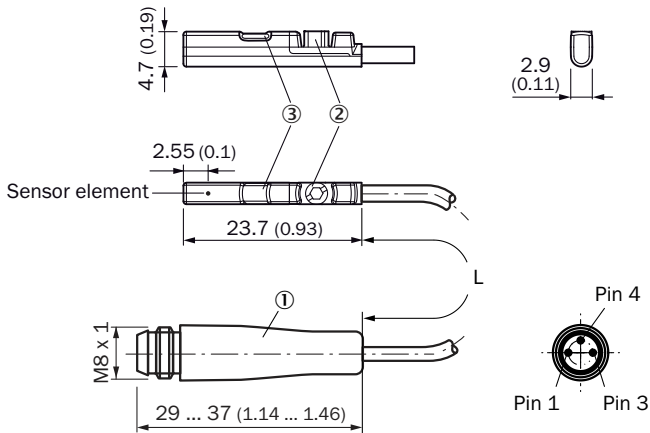









- ① Connection
- ② Fixing screw SW 1.5
- ③ Display LED

| Part no. | Type | L | Number of cores |
|----------|----------------|--------|-----------------|
| 1059735 | MZC1-2V2PS-KP0 | 300 mm | 3 |
| 1059744 | MZC1-2V2NS-KP0 | 300 mm | 3 |
| 1059752 | MZC1-4V3PS-KP0 | 300 mm | 3 |
| 1059757 | MZC1-4V3NS-KP0 | 300 mm | 3 |
| 1087247 | MZC1-2V2DS-KP0 | 300 mm | 2 |

Recommended accessories

Other models and accessories → www.sick.com/MZC1

| | Brief description | Type | Part no. |
|---|---|--------------------|----------|
| Brackets for cylinder sensors | | | |
|  | Mounting bracket for integrated profile cylinder/tie-rod cylinder, zinc diecast, mounting hardware included | BEF-KHZ-PC1 | 2076170 |
|  | 1 piece, Mounting bracket on round body cylinder with piston diameter of 12 mm, ambient temperature min 0 °C max 50 °C, plastic, Aluminum | BEF-KHZ-RC-12 | 2077673 |
| | 1 piece, Mounting bracket on round body cylinder with piston diameter of 16 mm, ambient temperature min 0 °C max 50 °C, plastic, Aluminum | BEF-KHZ-RC-16 | 2077672 |
| | 1 piece, Mounting bracket on round body cylinder with piston diameter of 20 mm, ambient temperature min 0 °C max 50 °C, plastic, Aluminum | BEF-KHZ-RC-20 | 2077671 |
| | 1 piece, Mounting bracket on round body cylinder with piston diameter of 25 mm, ambient temperature min 0 °C max 50 °C, plastic, Aluminum | BEF-KHZ-RC-25 | 2077670 |
| | 1 piece, Mounting bracket on round body cylinder with piston diameter of 32 mm, ambient temperature min 0 °C max 50 °C, plastic, Aluminum | BEF-KHZ-RC-32 | 2077669 |
| | 1 piece, Mounting bracket on round body cylinder with piston diameter of 40 mm, ambient temperature min 0 °C max 50 °C, plastic, Aluminum | BEF-KHZ-RC-40 | 2077668 |
| | 1 piece, Mounting bracket on round body cylinder with piston diameter of 50 mm, ambient temperature min 0 °C max 50 °C, plastic, Aluminum | BEF-KHZ-RC-50 | 2077667 |
| | 1 piece, Mounting bracket on round body cylinder with piston diameter of 63 mm, ambient temperature min 0 °C max 50 °C, plastic, Aluminum | BEF-KHZ-RC-63 | 2077666 |
|  | 1 piece, Mounting bracket on round body cylinder with piston diameter of 1 mm ... 130 mm, ambient temperature min -30 °C max 80 °C, stainless steel, Aluminum | BEF-KHZ-RC1-130 | 2077686 |
| | 1 piece, Mounting bracket on round body cylinder with piston diameter of 1 mm ... 25 mm, ambient temperature min -30 °C max 80 °C, stainless steel, Aluminum | BEF-KHZ-RC1-25 | 2077685 |
| Plug connectors and cables | | | |
|  | Head A: female connector, M8, 3-pin, straight, A-coded Head B: Flying leads Cable: Sensor/actuator cable, PVC, unshielded, 2 m | YF8U13-020VA1XLEAX | 2095860 |
| | Head A: female connector, M8, 3-pin, straight, A-coded Head B: Flying leads Cable: Sensor/actuator cable, PVC, unshielded, 5 m | YF8U13-050VA1XLEAX | 2095884 |
|  | Head A: female connector, M8, 3-pin, angled, A-coded Head B: Flying leads Cable: Sensor/actuator cable, PUR, halogen-free, unshielded, 2 m | YG8U13-020UA1XLEAX | 2094794 |
|  | Head A: female connector, M8, 3-pin, angled, A-coded Head B: Flying leads Cable: Sensor/actuator cable, PVC, unshielded, 2 m | YG8U13-020VA1XLEAX | 2096165 |
|  | Head A: female connector, M8, 3-pin, angled, A-coded Head B: Flying leads Cable: Sensor/actuator cable, PUR, halogen-free, unshielded, 5 m | YG8U13-050UA1XLEAX | 2095586 |
|  | Head A: female connector, M8, 3-pin, angled, A-coded Head B: Flying leads Cable: Sensor/actuator cable, PVC, unshielded, 5 m | YG8U13-050VA1XLEAX | 2096166 |
|  | Head A: female connector, M8, 3-pin, straight Cable: unshielded | DOS-0803-G | 7902077 |
|  | Head A: female connector, M8, 3-pin, angled Cable: unshielded | DOS-0803-W | 7902078 |

SICK AT A GLANCE

SICK is one of the leading manufacturers of intelligent sensors and sensor solutions for industrial applications. A unique range of products and services creates the perfect basis for controlling processes securely and efficiently, protecting individuals from accidents and preventing damage to the environment.

We have extensive experience in a wide range of industries and understand their processes and requirements. With intelligent sensors, we can deliver exactly what our customers need. In application centers in Europe, Asia and North America, system solutions are tested and optimized in accordance with customer specifications. All this makes us a reliable supplier and development partner.

Comprehensive services complete our offering: SICK LifeTime Services provide support throughout the machine life cycle and ensure safety and productivity.

For us, that is “Sensor Intelligence.”

WORLDWIDE PRESENCE:

Contacts and other locations www.sick.com