

<p>GlobTek, Inc. www.globtek.com 186 Veterans Drive, Northvale, NJ 07647 Tel. (201) 784-1000 Fax (201) 784-0111</p>	<p>Drawing Title: GTM96600-6024-R3A, ICT / ITE / Medical Power Supply/Class 2/Household Power Supply, Efficiency Level: USA DOE Level VI / Eco-design Directive 2009/125/EC, (EU) 2019/1782, Case Color/Style: GlobTek Black, Wall Plug-in+Desktop Combination, Regulated Switchmode AC-DC Power Supply AC Adaptor, Input Rating: 100-240V~, 50-60 Hz, IEC 60320/C6 w/ Wall Blades Option , Output Rating: 60W, 24.0V@2.5A, Output Configuration: 1500 mm, 18/1C + Shield Cond, UL 1185, Female Barrel 5.5 * 2.5 * 11mm with internal Spring Clip and Locking Notch or Equal, Ferrite: Core: RH 14.2*28.5*10, GlobTek Black, GT Cord # C3732, Pin Out: Center Positive (+V), symbol compliant with IEC 60417 symbol no. 5926, Blades/Input Cord: R-Series Desktop Insert, Approvals: cULus (12V only); India BIS (5,7.5, 12,18, 19,24,30 and 48V); CB 60335; Fuse 60335; 230V CoC Tier 2; ETL; NRCAN (5V only); South Africa; cETLus 60601-1; CB 62368; UKCA; UL 1310; Conforms to 62368-1; Morocco; Korea (21.0V-28.0V Only); NOM (12V only); NOM (5V only); ETL 62368; Malaysia; IRAM; 61558-1; IEC 61558-1; S-Mark 60950; CB 60950; ETL 60950; Class I; RCM; CCC; CB 60601-1; S-Mark IEC/EN 60601-1; EAC; ETL; CE; China RoHS; Level VI; LPS 60950; RoHS; Ukraine; VCCI; WEEE; PSE; PSE; PSE;</p>	
	<p>Model No. GTM96600-6024-R3A</p>	
	<p>Part No./Ordering No. RR9LI2500LCPCIMR6B</p>	<p>Rev B</p>

In Addition to GlobTek Inc.'s renewed ISO9001:2015 - Quality Management System Certification, GlobTek Inc. is now certified to:

ISO13485:2016 - Medical Devices Quality Management System Certification

ISO14001:2015 - Environmental Management System Certification

ISO Certificates are available online at <https://www.globtek.com/iso-certificates/>

The acceptance of this specification and use of the product described in this document indicates the acceptance and binding of the customer to Globtek TERMS AND CONDITIONS (attached to the end of this document), which supersede all other agreements, terms, and conditions (<https://en.globtek.com/terms-and-conditions/>).

The purchaser of this product (Customer) agrees that it is their sole responsibility to determine suitability/fitness of the product described in this specification for their application and to take precautions for protection against any hazards attendant to the handling and use of the product.

Footnote:

GlobTek Inc. will not be liable for the safety and performance of these power supplies/battery packs if unauthorized access and repair occurs. End user should consult applicable UL, CSA or EN standards for proper installation instruction.

Limitation of Use:

GlobTek products are intended for use with commercial, medical, and/or industrial equipment only. GlobTek product are not authorized for use as mission critical components in life support hazardous environment, nuclear or aircraft applications without prior written approval from the CEO of GlobTek Inc.

Contents of this document are subject to change without prior notice.

### Customer Approval of Specification:

Please approve, sign and send back to GlobTek so we can complete order processing.

A delay in receipt of this form will delay delivery schedule.

Company Name: _____	Customer P/N: _____
Quote Number: _____	Date: _____
Authorized Representative Name: _____	Authorized Representative Signature: _____

<b>GlobTek, Inc.</b> www.globtek.com 186 Veterans Drive, Northvale, NJ 07647 Tel. (201) 784-1000 Fax (201) 784-0111	Drawing Title: GTM96600-6024-R3A, ICT / ITE / Medical Power Supply/Class 2/Household Power Supply, Efficiency Level: USA DOE Level VI / Eco-design Directive 2009/125/EC, (EU) 2019/1782, Case Color/Style: GlobTek Black, Wall Plug-in+Desktop Combination, Regulated Switchmode AC-DC Power Supply AC Adaptor, Input Rating: 100-240V~, 50-60 Hz, IEC 60320/C6 w/ Wall Blades Option , Output Rating: 60W, 24.0V@2.5A, Output Configuration: 1500 mm, 18/1C + Shield Cond, UL 1185, Female Barrel 5.5 * 2.5 * 11mm with internal Spring Clip and Locking Notch or Equal, Ferrite: Core: RH 14.2*28.5*10, GlobTek Black, GT Cord # C3732, Pin Out: Center Positive (+V), symbol compliant with IEC 60417 symbol no. 5926, Blades/Input Cord: R-Series Desktop Insert, Approvals: cULus (12V only); India BIS (5,7.5, 12,18, 19,24,30 and 48V); CB 60335; Fuse 60335; 230V CoC Tier 2; ETL; NRCAN (5V only); South Africa; cETLus 60601-1; CB 62368; UKCA; UL 1310; Conforms to 62368-1; Morocco; Korea (21.0V-28.0V Only); NOM (12V only); NOM (5V only); ETL 62368; Malaysia; IRAM; 61558-1; IEC 61558-1; S-Mark 60950; CB 60950; ETL 60950; Class I; RCM; CCC; CB 60601-1; S-Mark IEC/EN 60601-1; EAC; ETL; CE; China RoHS; Level VI; LPS 60950; RoHS; Ukraine; VCCI; WEEE; PSE; PSE; PSE;	
	Model No. GTM96600-6024-R3A	
	Part No./Ordering No. RR9LI2500LCPCIMR6B	Rev B

## REVISION HISTORY

REV	DESCRIPTION	SUB	DATE	APPROVED
B	Update grounding configuration to E1	QA	02/26/2021	QA
A1	Update label specs to ISO 15223 medical device compliant label, add Morocco, EAC, BIS Conforms approvals, update CCC, Ukraine	QA	07/31/2020	QA
A	Initial Release	jwarn	05/02/2017	QA

### POWER SUPPLY INFORMATION

TYPE	Wall Plug-in+Desktop Combination
TECHNOLOGY	Regulated Switchmode AC-DC Power Supply AC Adaptor
CASE COLOR	GlobTek Black
NAMEPLATE RATED INPUT	100-240V~, 50-60 Hz, 1.5 A
INPUT CONFIG	IEC 60320/C6 w/ Wall Blades Option
WATTS	60.00
VOLTS OUT	24.0
CURRENT OUT (Amps)	2.5
BLADE/CORD INCLUDED	R-DI R-Series Desktop Insert
BLADE/CORD INSTALLED	R-DI :R-Series Desktop Insert
INGRESS PROTECTION	IP40, IP54 Option available
GROUNDING CONFIGURATION	(E1) Earthed output
EFFICIENCY LEVEL	<a href="#">USA DOE Level VI</a> / <a href="#">Eco-design Directive 2009/125/EC, (EU) 2019/1782 - Europe Code of Conduct on Energy Efficiency of External Power Supplies - Version 5</a>
OUTPUT CONFIGURATION	1500 mm, 18/1C + Shield Cond, UL 1185, Female Barrel 5.5 * 2.5 * 11mm with internal Spring Clip and Locking Notch or Equal, Ferrite: Core: RH 14.2*28.5*10, GlobTek Black, GT Cord # C3732
OVERMOLDED	Yes
OUTPUT CONNECTOR GENDER	Female
CONNECTOR PIN OUT	Center Positive (+V), symbol compliant with IEC 60417 symbol no. 5926
LABEL SPECS	ISO 15223 medical device compliant label,L-1470
SPECIAL BARCODE LABEL MATERIAL	No
PACK SPEC	Standard DT, Cellular packaging, User manual
USER MANUAL	809-DESKTOPUSERMANUAL on A4 paper

#### PROPRIETARY INFORMATION

PROPRIETARY OF GLOBTEK, INC. ANY REPRODUCTION, DISCLOSURE OR USE OF THIS DRAWING, IN WHOLE OR IN PART, IS HEREBY PROHIBITED EXCEPT AS SPECIFIED IN WRITING BY GLOBTEK, INC. © GlobTek, Inc. 2017 - 2023

<b>GlobTek, Inc.</b> <b>www.globtek.com</b> <b>186 Veterans Drive,</b> <b>Northvale, NJ 07647</b> <b>Tel. (201) 784-1000</b> <b>Fax (201) 784-0111</b>	Drawing Title: GTM96600-6024-R3A, ICT / ITE / Medical Power Supply/Class 2/Household Power Supply, Efficiency Level: USA DOE Level VI / Eco-design Directive 2009/125/EC, (EU) 2019/1782, Case Color/Style: GlobTek Black, Wall Plug-in+Desktop Combination, Regulated Switchmode AC-DC Power Supply AC Adaptor, Input Rating: 100-240V~, 50-60 Hz, IEC 60320/C6 w/ Wall Blades Option , Output Rating: 60W, 24.0V@2.5A, Output Configuration: 1500 mm, 18/1C + Shield Cond, UL 1185, Female Barrel 5.5 * 2.5 * 11mm with internal Spring Clip and Locking Notch or Equal, Ferrite: Core: RH 14.2*28.5*10, GlobTek Black, GT Cord # C3732, Pin Out: Center Positive (+V), symbol compliant with IEC 60417 symbol no. 5926, Blades/Input Cord: R-Series Desktop Insert, Approvals: cULus (12V only); India BIS (5,7.5, 12,18, 19,24,30 and 48V); CB 60335; Fuse 60335; 230V CoC Tier 2; ETL; NRCAN (5V only); South Africa; cETLus 60601-1; CB 62368; UKCA; UL 1310; Conforms to 62368-1; Morocco; Korea (21.0V-28.0V Only); NOM (12V only); NOM (5V only); ETL 62368; Malaysia; IRAM; 61558-1; IEC 61558-1; S-Mark 60950; CB 60950; ETL 60950; Class I; RCM; CCC; CB 60601-1; S-Mark IEC/EN 60601-1; EAC; ETL; CE; China RoHS; Level VI; LPS 60950; RoHS; Ukraine; VCCI; WEEE; PSE; PSE; PSE;	
	<b>Model No. GTM96600-6024-R3A</b>	
	<b>Part No./Ordering No. RR9LI2500LCPCIMR6B</b>	<b>Rev B</b>

Notes/Modifications/Customizations (notes in this section supersede the values shown in the standard spec)

DIMENSIONS ARE IN MM UNLESS SPECIFIED OTHERWISE

<b>GlobTek, Inc.</b> www.globtek.com 186 Veterans Drive, Northvale, NJ 07647 Tel. (201) 784-1000 Fax (201) 784-0111	Drawing Title: GTM96600-6024-R3A, ICT / ITE / Medical Power Supply/Class 2/Household Power Supply, Efficiency Level: USA DOE Level VI / Eco-design Directive 2009/125/EC, (EU) 2019/1782, Case Color/Style: GlobTek Black, Wall Plug-in+Desktop Combination, Regulated Switchmode AC-DC Power Supply AC Adaptor, Input Rating: 100-240V~, 50-60 Hz, IEC 60320/C6 w/ Wall Blades Option , Output Rating: 60W, 24.0V@2.5A, Output Configuration: 1500 mm, 18/1C + Shield Cond, UL 1185, Female Barrel 5.5 * 2.5 * 11mm with internal Spring Clip and Locking Notch or Equal, Ferrite: Core: RH 14.2*28.5*10, GlobTek Black, GT Cord # C3732, Pin Out: Center Positive (+V), symbol compliant with IEC 60417 symbol no. 5926, Blades/Input Cord: R-Series Desktop Insert, Approvals: cULus (12V only); India BIS (5,7.5, 12,18, 19,24,30 and 48V); CB 60335; Fuse 60335; 230V CoC Tier 2; ETL; NRCAN (5V only); South Africa; cETLus 60601-1; CB 62368; UKCA; UL 1310; Conforms to 62368-1; Morocco; Korea (21.0V-28.0V Only); NOM (12V only); NOM (5V only); ETL 62368; Malaysia; IRAM; 61558-1; IEC 61558-1; S-Mark 60950; CB 60950; ETL 60950; Class I; RCM; CCC; CB 60601-1; S-Mark IEC/EN 60601-1; EAC; ETL; CE; China RoHS; Level VI; LPS 60950; RoHS; Ukraine; VCCI; WEEE; PSE; PSE; PSE;	
	Model No. GTM96600-6024-R3A	
	Part No./Ordering No. RR9LI2500LCPCIMR6B	Rev B

## ELECTRICAL SPECIFICATIONS

### Input

Input Voltage:	Specified: 90-264VAC, Nameplate: 100-240VAC 100% rated load current for 90-264VAC 85% rated load current for 85-264VAC 100% rated load current for 110-370VDC
Input Frequency:	Specified: 47-63Hz, Nameplate: 50-60Hz
No Load Input Power:	<75mW @ 230VAC (EU CoC Tier 2 compliant) for ≤ 49W rating <150mW @ 230VAC (EU CoC Tier 2 compliant) for > 49W rating
Inrush Current:	30A/60A max. (cold start @ 115V/230VAC)
Efficiency:	DoE Level VI and EU CoC Tier 2 compliant

### Output

Turn-on Delay:	1 second max. @ 115VAC and full load
Output Regulation:	± 5% (measured at output connector)
Line Regulation:	± 0.5% typ. (measured at output connector)
Ripple:	1% or 100mV, whichever is greater (using a 47µF low-ESR cap + 0.1µF ceramic capacitor, measured @ 20MHz BW, at output connector)
Transient Response:	5% max. deviation, 1ms typ. recovery time (with 40% to 70% load step)
Hold-up Time:	8ms typ. (nominal input voltage and full load)
Power Indicator:	Green LED

### Protections

Input Protection:	MOV transient suppressor, input line fusing
Over-Current Protection:	110 - 160% of rated output current, auto-restart, current limit range determined by normal output power rating, not de-rated power rating
Short-Circuit Protection:	Auto-restart
Over-Voltage Protection:	110 - 130%, latched off, cycle AC to reset
Over-Temperature Protection:	On-chip temperature sensor (integrated in primary-side switching controller), shut down at Tj = ~140°C, latched off, cycle AC to reset

### Environmental

<b>GlobTek, Inc.</b> www.globtek.com 186 Veterans Drive, Northvale, NJ 07647 Tel. (201) 784-1000 Fax (201) 784-0111	Drawing Title: GTM96600-6024-R3A, ICT / ITE / Medical Power Supply/Class 2/Household Power Supply, Efficiency Level: USA DOE Level VI / Eco-design Directive 2009/125/EC, (EU) 2019/1782, Case Color/Style: GlobTek Black, Wall Plug-in+Desktop Combination, Regulated Switchmode AC-DC Power Supply AC Adaptor, Input Rating: 100-240V~, 50-60 Hz, IEC 60320/C6 w/ Wall Blades Option , Output Rating: 60W, 24.0V@2.5A, Output Configuration: 1500 mm, 18/1C + Shield Cond, UL 1185, Female Barrel 5.5 * 2.5 * 11mm with internal Spring Clip and Locking Notch or Equal, Ferrite: Core: RH 14.2*28.5*10, GlobTek Black, GT Cord # C3732, Pin Out: Center Positive (+V), symbol compliant with IEC 60417 symbol no. 5926, Blades/Input Cord: R-Series Desktop Insert, Approvals: cULus (12V only); India BIS (5,7.5, 12,18, 19,24,30 and 48V); CB 60335; Fuse 60335; 230V CoC Tier 2; ETL; NRCAN (5V only); South Africa; cETLus 60601-1; CB 62368; UKCA; UL 1310; Conforms to 62368-1; Morocco; Korea (21.0V-28.0V Only); NOM (12V only); NOM (5V only); ETL 62368; Malaysia; IRAM; 61558-1; IEC 61558-1; S-Mark 60950; CB 60950; ETL 60950; Class I; RCM; CCC; CB 60601-1; S-Mark IEC/EN 60601-1; EAC; ETL; CE; China RoHS; Level VI; LPS 60950; RoHS; Ukraine; VCCI; WEEE; PSE; PSE; PSE;	
	Model No. GTM96600-6024-R3A	
	Part No./Ordering No. RR9LI2500LCPCIMR6B	Rev B

MTBF:	1,500,000 hours @ 25°C ambient, full load (Telcordia SR-332, Issue 3)
Operating Temperature:	-20°C to 40°C (full load)
Storage Temperature:	-30°C to 80°C
Humidity:	0% to 95% relative humidity, non-condensing
Altitude:	5000m
Cooling:	Convection
RoHS:	Complies with EU 2011/65/EU and China SJ/T 11363-2006
Note 1:	Regarding operating temperature a. See below de-rating table for output power capability at alternate temperature b. Extended low-end temperature range available as a custom option

## Safety

Dielectric Withstand Voltage:	4000VAC or 5656VDC from input to output 3000VAC or 4242VDC from input to earth (Class I models only)
Touch Current:	Class I: 20µA max. Class II: 85µA max. Class II F2: 20µA max.
Earth Leakage Current	Class I: 300µA max. Class II: N/A
Means of Protection:	2 x MOPP
Output Isolation Options:	Class I: C6 or C14 inlet (output negative tied to Earth contact) Class II: C8 or C18 inlet Class II FE: C6 or C14 inlet (output isolated from Earth contact) Review isolation options by reading our white paper <a href="#">PSU Isolation and Identity</a> .
Earth Continuity Test:	< 0.1Ω between earth pin (on AC inlet) and PCB termination point (Class I models only)
Compliant Standards:	See listing at end of this datasheet for specific standards

## EMC

<b>GlobTek, Inc.</b> www.globtek.com 186 Veterans Drive, Northvale, NJ 07647 Tel. (201) 784-1000 Fax (201) 784-0111	Drawing Title: GTM96600-6024-R3A, ICT / ITE / Medical Power Supply/Class 2/Household Power Supply, Efficiency Level: USA DOE Level VI / Eco-design Directive 2009/125/EC, (EU) 2019/1782, Case Color/Style: GlobTek Black, Wall Plug-in+Desktop Combination, Regulated Switchmode AC-DC Power Supply AC Adaptor, Input Rating: 100-240V~, 50-60 Hz, IEC 60320/C6 w/ Wall Blades Option , Output Rating: 60W, 24.0V@2.5A, Output Configuration: 1500 mm, 18/1C + Shield Cond, UL 1185, Female Barrel 5.5 * 2.5 * 11mm with internal Spring Clip and Locking Notch or Equal, Ferrite: Core: RH 14.2*28.5*10, GlobTek Black, GT Cord # C3732, Pin Out: Center Positive (+V), symbol compliant with IEC 60417 symbol no. 5926, Blades/Input Cord: R-Series Desktop Insert, Approvals: cULus (12V only); India BIS (5,7.5, 12,18, 19,24,30 and 48V); CB 60335; Fuse 60335; 230V CoC Tier 2; ETL; NRCAN (5V only); South Africa; cETLus 60601-1; CB 62368; UKCA; UL 1310; Conforms to 62368-1; Morocco; Korea (21.0V-28.0V Only); NOM (12V only); NOM (5V only); ETL 62368; Malaysia; IRAM; 61558-1; IEC 61558-1; S-Mark 60950; CB 60950; ETL 60950; Class I; RCM; CCC; CB 60601-1; S-Mark IEC/EN 60601-1; EAC; ETL; CE; China RoHS; Level VI; LPS 60950; RoHS; Ukraine; VCCI; WEEE; PSE; PSE; PSE;	
	Model No. GTM96600-6024-R3A	
	Part No./Ordering No. RR9LI2500LCPCIMR6B	Rev B

<b>Applicable Standards:</b>	Medical: EN60601-1-2, 4th edition Emissions: EN55032, EN61000-6-3, EN61000-6-4, CISPR11, CISPR22 Immunity: EN55024, EN61000-6-1, EN61000-6-2
<b>Conducted Emissions:</b>	Class B, FCC Part 15, Class B (with resistive load)
<b>Radiated Emissions:</b>	Class B, FCC Part 15, Class B (with resistive load)
<b>Harmonic Current Voltage Distortion:</b>	EN61000-3-2, Class A
<b>Voltage Fluctuations/Flicker:</b>	EN61000-3-3
<b>Electrostatic Discharge (ESD) Immunity:</b>	EN61000-4-2, 10KV contact discharge, 20KV air discharge
<b>Radiated RF Immunity:</b>	EN61000-4-3, 10V/m 80-1000MHz, 3V/m 1-2.7GHz, 80% 1KHz AM
<b>EFT/Burst Immunity:</b>	EN61000-4-4, 4KV/100kHz.
<b>Line Surge Immunity:</b>	EN61000-4-5, 2KV differential, 4KV common-mode
<b>Conducted RF Immunity:</b>	EN61000-4-6, 3VRMS, 80% 1KHz AM
<b>Power Frequency Magnetic Field Immunity:</b>	EN61000-4-8, 3A/m
<b>Voltage Dip Immunity:</b>	EN61000-4-11

## Enclosure

<b>Housing:</b>	High impact plastic, 94V0 polycarbonate, non-vented
<b>AC Input Mechanical Options:</b>	Desktop: C6, C7, C14, or C18 inlet Hybrid: Desktop inlet or changeable blades for wall-plug-in style, Class I or Class II input
<b>Markings:</b>	Label and/or pad printed and/or laser-etched into case

## Special Options

1. Removal of LED (cost reduction or aesthetic purpose)
2. Custom cordsets, various cordage types, and connector types
3. Custom markings
4. Short term output surge capability for motors or other high peak current loads. (Available up to 120W for 1 second at nameplate voltage range. Higher levels possible for limited input voltage range, or larger allowed voltage dip.)
5. Reduced leakage current
6. Tightened output voltage tolerance
7. Reduced output ripple level
8. Reduced output power rating
9. High reliability PCB laminate with plated through-holes for IPC610 Class 2 compliance
10. Low temperature option, down to -40°C
11. Special housing and cordset colors
12. "Back EMF" upgrade, for motor loads and other high inductance applications with reverse energy flow requirements
13. Improved ingress protection (IP) rating

## Output Connectors

<p>GlobTek, Inc. www.globtek.com 186 Veterans Drive, Northvale, NJ 07647 Tel. (201) 784-1000 Fax (201) 784-0111</p>	<p>Drawing Title: GTM96600-6024-R3A, ICT / ITE / Medical Power Supply/Class 2/Household Power Supply, Efficiency Level: USA DOE Level VI / Eco-design Directive 2009/125/EC, (EU) 2019/1782, Case Color/Style: GlobTek Black, Wall Plug-in+Desktop Combination, Regulated Switchmode AC-DC Power Supply AC Adaptor, Input Rating: 100-240V~, 50-60 Hz, IEC 60320/C6 w/ Wall Blades Option , Output Rating: 60W, 24.0V@2.5A, Output Configuration: 1500 mm, 18/1C + Shield Cond, UL 1185, Female Barrel 5.5 * 2.5 * 11mm with internal Spring Clip and Locking Notch or Equal, Ferrite: Core: RH 14.2*28.5*10, GlobTek Black, GT Cord # C3732, Pin Out: Center Positive (+V), symbol compliant with IEC 60417 symbol no. 5926, Blades/Input Cord: R-Series Desktop Insert, Approvals: cULus (12V only); India BIS (5,7.5, 12,18, 19,24,30 and 48V); CB 60335; Fuse 60335; 230V CoC Tier 2; ETL; NRCAN (5V only); South Africa; cETLus 60601-1; CB 62368; UKCA; UL 1310; Conforms to 62368-1; Morocco; Korea (21.0V-28.0V Only); NOM (12V only); NOM (5V only); ETL 62368; Malaysia; IRAM; 61558-1; IEC 61558-1; S-Mark 60950; CB 60950; ETL 60950; Class I; RCM; CCC; CB 60601-1; S-Mark IEC/EN 60601-1; EAC; ETL; CE; China RoHS; Level VI; LPS 60950; RoHS; Ukraine; VCCI; WEEE; PSE; PSE; PSE;</p>	
	<p>Model No. GTM96600-6024-R3A</p>	
	<p>Part No./Ordering No. RR9LI2500LCPCIMR6B</p>	<p>Rev B</p>

- Several output connector options are available with various output current ratings. GlobTek can supply 10A rated 2.1mm and 2.5mm style DC Power Jacks, to complement our 10A output rated 2.1mm and 2.5mm DC power plugs used on our output cordsets.

- Please visit our real-time listing of mating connector product offering:

<https://en.globtek.com/news/high-current-coaxial-barrel-plug-jacks-for-high-wattage-power-supplies>

TO ADDRESS SYSTEM-LEVEL EMI CONCERNS, FERRITE CHOKES/BEADS MAY BE ADDED/REVISED UPON REQUEST. A SAMPLE KIT OF GLOBTEK'S STANDARD FERRITES IS AVAILABLE UNDER GLOBTEK P/N: EMI-MITIGATION-KIT1

FOR ADDITIONAL INFORMATION, PLEASE READ OUR WHITE PAPER AT: <https://r.globtek.info/3QeaqtD>

INGRESS PROTECTION: IP40, IP54 Option available

GlobTek, Inc.  
 www.globtek.com  
 186 Veterans Drive,  
 Northvale, NJ 07647  
 Tel. (201) 784-1000  
 Fax (201) 784-0111

Drawing Title: GTM96600-6024-R3A, ICT / ITE / Medical Power Supply/Class 2/Household Power Supply, Efficiency Level: USA DOE Level VI / Eco-design Directive 2009/125/EC, (EU) 2019/1782, Case Color/Style: GlobTek Black, Wall Plug-in+Desktop Combination, Regulated Switchmode AC-DC Power Supply AC Adaptor, Input Rating: 100-240V~, 50-60 Hz, IEC 60320/C6 w/ Wall Blades Option , Output Rating: 60W, 24.0V@2.5A, Output Configuration: 1500 mm, 18/1C + Shield Cond, UL 1185, Female Barrel 5.5 \* 2.5 \* 11mm with internal Spring Clip and Locking Notch or Equal, Ferrite: Core: RH 14.2\*28.5\*10, GlobTek Black, GT Cord # C3732, Pin Out: Center Positive (+V), symbol compliant with IEC 60417 symbol no. 5926, Blades/Input Cord: R-Series Desktop Insert, Approvals: cULus (12V only); India BIS (5,7.5, 12,18, 19,24,30 and 48V); CB 60335; Fuse 60335; 230V CoC Tier 2; ETL; NRCAN (5V only); South Africa; cETLus 60601-1; CB 62368; UKCA; UL 1310; Conforms to 62368-1; Morocco; Korea (21.0V-28.0V Only); NOM (12V only); NOM (5V only); ETL 62368; Malaysia; IRAM; 61558-1; IEC 61558-1; S-Mark 60950; CB 60950; ETL 60950; Class I; RCM; CCC; CB 60601-1; S-Mark IEC/EN 60601-1; EAC; ETL; CE; China RoHS; Level VI; LPS 60950; RoHS; Ukraine; VCCI; WEEE; PSE; PSE; PSE;

Model No. GTM96600-6024-R3A

Part No./Ordering No. RR9LI2500LCPCIMR6B

Rev B

3D File Download <https://www.globtek.com/dl/GTM96600-R3.igs>

Mechanical drawing

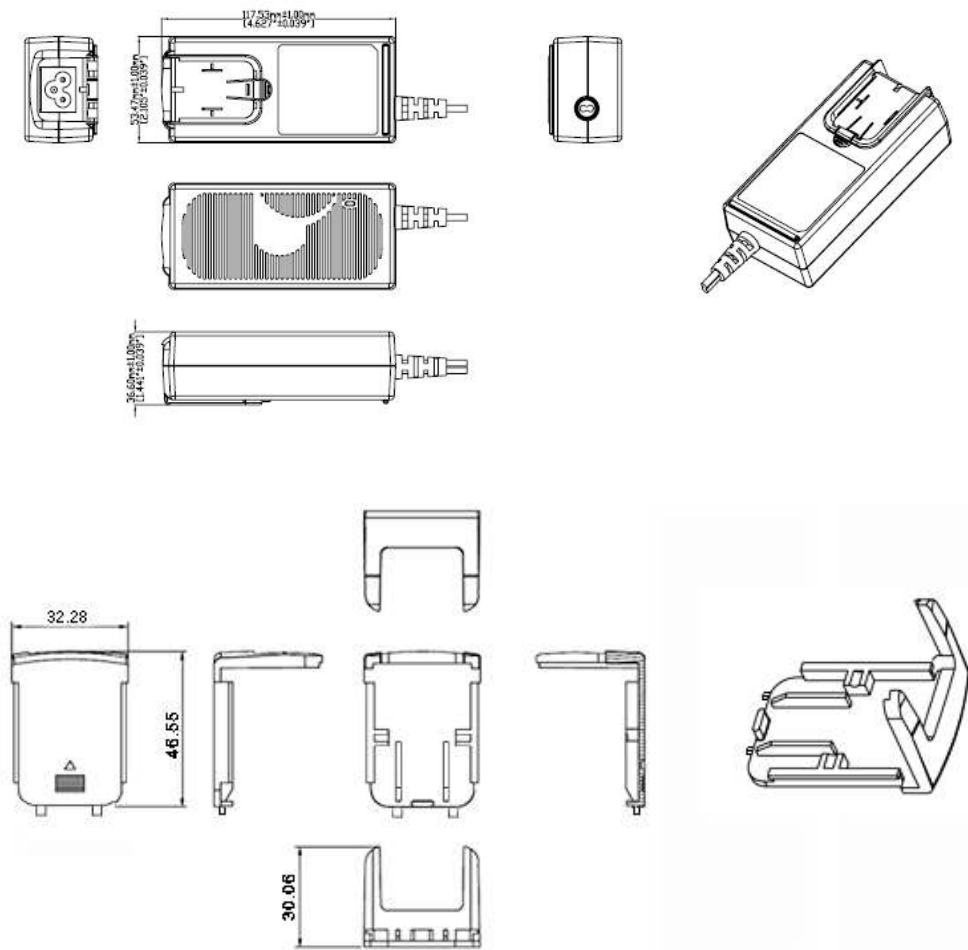

Unit shipped without an installed input plug.  
 "Desktop insert" installed.



<p>GlobTek, Inc. www.globtek.com 186 Veterans Drive, Northvale, NJ 07647 Tel. (201) 784-1000 Fax (201) 784-0111</p>	<p>Drawing Title: GTM96600-6024-R3A, ICT / ITE / Medical Power Supply/Class 2/Household Power Supply, Efficiency Level: USA DOE Level VI / Eco-design Directive 2009/125/EC, (EU) 2019/1782, Case Color/Style: GlobTek Black, Wall Plug-in+Desktop Combination, Regulated Switchmode AC-DC Power Supply AC Adaptor, Input Rating: 100-240V~, 50-60 Hz, IEC 60320/C6 w/ Wall Blades Option , Output Rating: 60W, 24.0V@2.5A, Output Configuration: 1500 mm, 18/1C + Shield Cond, UL 1185, Female Barrel 5.5 * 2.5 * 11mm with internal Spring Clip and Locking Notch or Equal, Ferrite: Core: RH 14.2*28.5*10, GlobTek Black, GT Cord # C3732, Pin Out: Center Positive (+V), symbol compliant with IEC 60417 symbol no. 5926, Blades/Input Cord: R-Series Desktop Insert, Approvals: cULus (12V only); India BIS (5,7.5, 12,18, 19,24,30 and 48V); CB 60335; Fuse 60335; 230V CoC Tier 2; ETL; NRCAN (5V only); South Africa; cETLus 60601-1; CB 62368; UKCA; UL 1310; Conforms to 62368-1; Morocco; Korea (21.0V-28.0V Only); NOM (12V only); NOM (5V only); ETL 62368; Malaysia; IRAM; 61558-1; IEC 61558-1; S-Mark 60950; CB 60950; ETL 60950; Class I; RCM; CCC; CB 60601-1; S-Mark IEC/EN 60601-1; EAC; ETL; CE; China RoHS; Level VI; LPS 60950; RoHS; Ukraine; VCCI; WEEE; PSE; PSE; PSE;</p>	
	<p>Model No. GTM96600-6024-R3A</p>	
	<p>Part No./Ordering No. RR9LI2500LCPCIMR6B</p>	<p>Rev B</p>

DERATING CURVE

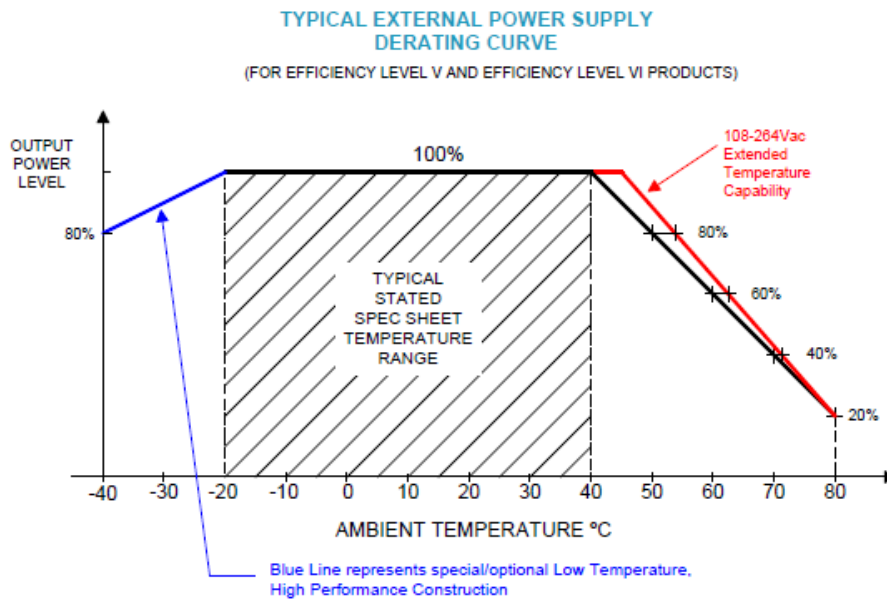

+74C operation with an output power of 19.2W; and cold start at -40C

<p>GlobTek, Inc. www.globtek.com 186 Veterans Drive, Northvale, NJ 07647 Tel. (201) 784-1000 Fax (201) 784-0111</p>	<p>Drawing Title: GTM96600-6024-R3A, ICT / ITE / Medical Power Supply/Class 2/Household Power Supply, Efficiency Level: USA DOE Level VI / Eco-design Directive 2009/125/EC, (EU) 2019/1782, Case Color/Style: GlobTek Black, Wall Plug-in+Desktop Combination, Regulated Switchmode AC-DC Power Supply AC Adaptor, Input Rating: 100-240V~, 50-60 Hz, IEC 60320/C6 w/ Wall Blades Option , Output Rating: 60W, 24.0V@2.5A, Output Configuration: 1500 mm, 18/1C + Shield Cond, UL 1185, Female Barrel 5.5 * 2.5 * 11mm with internal Spring Clip and Locking Notch or Equal, Ferrite: Core: RH 14.2*28.5*10, GlobTek Black, GT Cord # C3732, Pin Out: Center Positive (+V), symbol compliant with IEC 60417 symbol no. 5926, Blades/Input Cord: R-Series Desktop Insert, Approvals: cULus (12V only); India BIS (5,7.5, 12,18, 19,24,30 and 48V); CB 60335; Fuse 60335; 230V CoC Tier 2; ETL; NRCAN (5V only); South Africa; cETLus 60601-1; CB 62368; UKCA; UL 1310; Conforms to 62368-1; Morocco; Korea (21.0V-28.0V Only); NOM (12V only); NOM (5V only); ETL 62368; Malaysia; IRAM; 61558-1; IEC 61558-1; S-Mark 60950; CB 60950; ETL 60950; Class I; RCM; CCC; CB 60601-1; S-Mark IEC/EN 60601-1; EAC; ETL; CE; China RoHS; Level VI; LPS 60950; RoHS; Ukraine; VCCI; WEEE; PSE; PSE; PSE;</p>	
	<p>Model No. GTM96600-6024-R3A</p>	
	<p>Part No./Ordering No. RR9LI2500LCPCIMR6B</p>	<p>Rev B</p>

**INPUT CONFIGURATION**

(E1) Earthed output

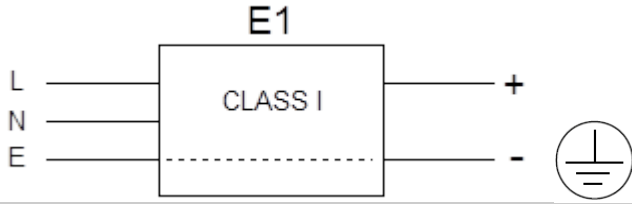

[Alternate grounding configurations](#) available upon request.

Blades/Cord Included:R-DI:R-Series Desktop Insert

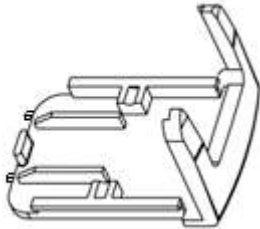

Desktop Insert Installed

Blades/Cord Installed:R-DI:R-Series Desktop Insert

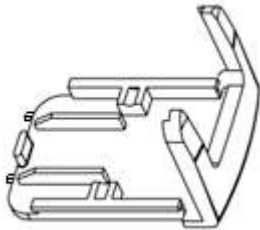

Desktop Insert Installed

IEC 60320/C6 AC Inlet Connector, Class I, Earth Ground ( aka "Mickey Mouse")

<p>GlobTek, Inc. www.globtek.com 186 Veterans Drive, Northvale, NJ 07647 Tel. (201) 784-1000 Fax (201) 784-0111</p>	<p>Drawing Title: GTM96600-6024-R3A, ICT / ITE / Medical Power Supply/Class 2/Household Power Supply, Efficiency Level: USA DOE Level VI / Eco-design Directive 2009/125/EC, (EU) 2019/1782, Case Color/Style: GlobTek Black, Wall Plug-in+Desktop Combination, Regulated Switchmode AC-DC Power Supply AC Adaptor, Input Rating: 100-240V~, 50-60 Hz, IEC 60320/C6 w/ Wall Blades Option , Output Rating: 60W, 24.0V@2.5A, Output Configuration: 1500 mm, 18/1C + Shield Cond, UL 1185, Female Barrel 5.5 * 2.5 * 11mm with internal Spring Clip and Locking Notch or Equal, Ferrite: Core: RH 14.2*28.5*10, GlobTek Black, GT Cord # C3732, Pin Out: Center Positive (+V), symbol compliant with IEC 60417 symbol no. 5926, Blades/Input Cord: R-Series Desktop Insert, Approvals: cULus (12V only); India BIS (5,7.5, 12,18, 19,24,30 and 48V); CB 60335; Fuse 60335; 230V CoC Tier 2; ETL; NRCAN (5V only); South Africa; cETLus 60601-1; CB 62368; UKCA; UL 1310; Conforms to 62368-1; Morocco; Korea (21.0V-28.0V Only); NOM (12V only); NOM (5V only); ETL 62368; Malaysia; IRAM; 61558-1; IEC 61558-1; S-Mark 60950; CB 60950; ETL 60950; Class I; RCM; CCC; CB 60601-1; S-Mark IEC/EN 60601-1; EAC; ETL; CE; China RoHS; Level VI; LPS 60950; RoHS; Ukraine; VCCI; WEEE; PSE; PSE; PSE;</p>	
	<p>Model No. GTM96600-6024-R3A</p>	
	<p>Part No./Ordering No. RR9LI2500LCPCIMR6B</p>	<p>Rev B</p>

[Blade Insertion Instructions](#)  
[R-Blade Style Instruction Video](#)

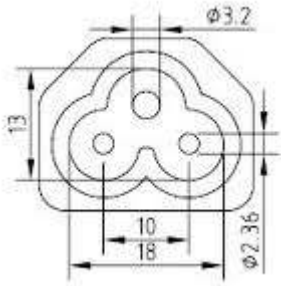

Mates with IEC 60320/C5 Plug

This series of Interchangeable Blade products may be used with Proprietary Interchangeable Blades as described below or with standard international power cords.

Optional INPUT BLADES: R-Socket: below are available blades configurations which are "not included" (unless stated above); may be purchased separately, packaged with power supply, or as a separate "R-KIT" if specified

1. Class I model NEMA 5-15P (Type B), Class I AC power plug with 2 blades & ground pin, R-NA-3(R)
2. Australian AS 3112 (Type I) configuration: SAA 3 pins Class I, R-SAA-3(R)
3. UK BS 1363 (Type G) configuration: UK 3 pins (Ground) Class I, R-UK-3(R)
4. European CEE 7/7 (Type E and F) configuration: European plug 2 PINS + ground, Class I, R-EU-3(R)
5. Desktop Insert
- Kits
05. R-KIT-3(R) 1,2,3,4 above
06. R-KIT-3-INTL(R): 2,3,4 above

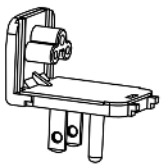

**UL 3P**

P/N: R-NA-3(R)  
NORTH AMERICA  
JAPAN

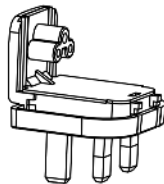

**UK 3P**

P/N: R-UK-3(R)  
UNITED KINGDOM  
HONG KONG  
SINGAPORE

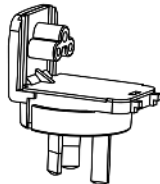

**AUS 3P**

P/N: R-SAA-3(R)  
AUSTRALIA

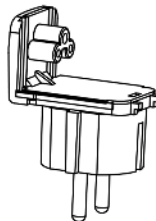

**EU 3P**

P/N: R-EU-3(R)  
EUROPE  
SOUTH AMERICA

Below are standard cordsets which are "not included" (unless stated above); these can be purchased separately or package with the power supply. Contact your Sales Engineer if the style required is not shown below. Many more available in different lengths, colors or cable material.

[Standard International IEC 320/C5 Cordsets](#)

GlobTek, Inc. www.globtek.com 186 Veterans Drive, Northvale, NJ 07647 Tel. (201) 784-1000 Fax (201) 784-0111	Drawing Title: GTM96600-6024-R3A, ICT / ITE / Medical Power Supply/Class 2/Household Power Supply, Efficiency Level: USA DOE Level VI / Eco-design Directive 2009/125/EC, (EU) 2019/1782, Case Color/Style: GlobTek Black, Wall Plug-in+Desktop Combination, Regulated Switchmode AC-DC Power Supply AC Adaptor, Input Rating: 100-240V~, 50-60 Hz, IEC 60320/C6 w/ Wall Blades Option , Output Rating: 60W, 24.0V@2.5A, Output Configuration: 1500 mm, 18/1C + Shield Cond, UL 1185, Female Barrel 5.5 * 2.5 * 11mm with internal Spring Clip and Locking Notch or Equal, Ferrite: Core: RH 14.2*28.5*10, GlobTek Black, GT Cord # C3732, Pin Out: Center Positive (+V), symbol compliant with IEC 60417 symbol no. 5926, Blades/Input Cord: R-Series Desktop Insert, Approvals: cULus (12V only); India BIS (5,7.5, 12,18, 19,24,30 and 48V); CB 60335; Fuse 60335; 230V CoC Tier 2; ETL; NRCAN (5V only); South Africa; cETLus 60601-1; CB 62368; UKCA; UL 1310; Conforms to 62368-1; Morocco; Korea (21.0V-28.0V Only); NOM (12V only); NOM (5V only); ETL 62368; Malaysia; IRAM; 61558-1; IEC 61558-1; S-Mark 60950; CB 60950; ETL 60950; Class I; RCM; CCC; CB 60601-1; S-Mark IEC/EN 60601-1; EAC; ETL; CE; China RoHS; Level VI; LPS 60950; RoHS; Ukraine; VCCI; WEEE; PSE; PSE; PSE;	
	Model No. GTM96600-6024-R3A	
	Part No./Ordering No. RR9LI2500LCPCIMR6B	Rev B

Part Number / Link	Country	Plug	Connector	Length (mm)	Length (ft)
<a href="#">3021066F712(R)</a>	N. American (Type B)	NEMA 5-15P	IEC 320/C5	1880	6
<a href="#">1191068F0712(R)</a>	N. American (Type B)	NEMA 5-15P Hospital	IEC 320/C5	2459	8
<a href="#">2194262M0712(R)</a>	Argentina (Type I)	IRAM 2073	IEC320/C5	2050	6.7
<a href="#">2064262M0712(R)</a>	Australian (Type I)	AS3112 / 3 PRONG	IEC 320/C5	2000	6.6
<a href="#">204B4262M0712(R)</a>	Brazil (Type N)	BRAZIL	IEC 320/C5	2000	6.6
<a href="#">6023592M5712(R)</a>	China (Type I)	CCC GR2099	IEC 320/C5	2500	8
<a href="#">23144262M0712(R)</a>	Europe (Type E)	CEE 7/7	IEC 320/C5	2050	6.6
<a href="#">2313K3432M0712(R)</a>	Korea (Type F)	KS C 8305	IEC 320/C5	2000	6.6
<a href="#">205IN4262M0712(R)</a>	India (Type D)	India IS 1293 (also known as IA16A3 or BS546)	IEC320/C5	2000	6.6
<a href="#">377C4262M0712(R)</a>	Israel (Type H)	ISL	IEC320/C5	2050	6.7
<a href="#">23024262M0712(R)</a>	Italy (Type L)	CEI 23-16/VII	IEC 320/C5	2000	6.6
<a href="#">3003316F0712(R)</a>	Japan (Type B)	JIS 8303 / 3 PINS	IEC 320/C5	1830	6
<a href="#">3021066F0712ULPSE(R)</a>	Japan / USA (Type B)	JIS 8303 / 3 PINS + NEMA 5-15P	IEC 320/C5	1830	6
<a href="#">2054262M0712(R)</a>	S. Africa (Type D)	South Africa SABS164-1 (6A type plug)	IEC320/C5	2050	6.7
<a href="#">2084262M0712(R)</a>	S.Africa (Type M)	South Africa SABS164-1 (16A type plug)	IEC 320/C5	2000	6.6
<a href="#">23214262M0712(R)</a>	Switzerland (Type J)	SEV 1011 ( EL 203)	IEC 320/C5	2000	6.6
<a href="#">3003316F0712(R)</a>	Taiwan (Type B)	BSMI	IEC 320/C5	2000	6.6
<a href="#">6104262M0712(R)</a>	UK, Hong Kong, Singapore, Gulf States (Type G)	BS1363	IEC 320/C5	2000	6.6

<p>GlobTek, Inc. www.globtek.com 186 Veterans Drive, Northvale, NJ 07647 Tel. (201) 784-1000 Fax (201) 784-0111</p>	<p>Drawing Title: GTM96600-6024-R3A, ICT / ITE / Medical Power Supply/Class 2/Household Power Supply, Efficiency Level: USA DOE Level VI / Eco-design Directive 2009/125/EC, (EU) 2019/1782, Case Color/Style: GlobTek Black, Wall Plug-in+Desktop Combination, Regulated Switchmode AC-DC Power Supply AC Adaptor, Input Rating: 100-240V~, 50-60 Hz, IEC 60320/C6 w/ Wall Blades Option , Output Rating: 60W, 24.0V@2.5A, Output Configuration: 1500 mm, 18/1C + Shield Cond, UL 1185, Female Barrel 5.5 * 2.5 * 11mm with internal Spring Clip and Locking Notch or Equal, Ferrite: Core: RH 14.2*28.5*10, GlobTek Black, GT Cord # C3732, Pin Out: Center Positive (+V), symbol compliant with IEC 60417 symbol no. 5926, Blades/Input Cord: R-Series Desktop Insert, Approvals: cULus (12V only); India BIS (5,7.5, 12,18, 19,24,30 and 48V); CB 60335; Fuse 60335; 230V CoC Tier 2; ETL; NRCAN (5V only); South Africa; cETLus 60601-1; CB 62368; UKCA; UL 1310; Conforms to 62368-1; Morocco; Korea (21.0V-28.0V Only); NOM (12V only); NOM (5V only); ETL 62368; Malaysia; IRAM; 61558-1; IEC 61558-1; S-Mark 60950; CB 60950; ETL 60950; Class I; RCM; CCC; CB 60601-1; S-Mark IEC/EN 60601-1; EAC; ETL; CE; China RoHS; Level VI; LPS 60950; RoHS; Ukraine; VCCI; WEEE; PSE; PSE; PSE;</p>	
	<p>Model No. GTM96600-6024-R3A</p>	
	<p>Part No./Ordering No. RR9LI2500LCPCIMR6B</p>	<p>Rev B</p>



GlobTek, Inc.  
 www.globtek.com  
 186 Veterans Drive,  
 Northvale, NJ 07647  
 Tel. (201) 784-1000  
 Fax (201) 784-0111

Drawing Title: GTM96600-6024-R3A, ICT / ITE / Medical Power Supply/Class 2/Household Power Supply, Efficiency Level: USA DOE Level VI / Eco-design Directive 2009/125/EC, (EU) 2019/1782, Case Color/Style: GlobTek Black, Wall Plug-in+Desktop Combination, Regulated Switchmode AC-DC Power Supply AC Adaptor, Input Rating: 100-240V~, 50-60 Hz, IEC 60320/C6 w/ Wall Blades Option , Output Rating: 60W, 24.0V@2.5A, Output Configuration: 1500 mm, 18/1C + Shield Cond, UL 1185, Female Barrel 5.5 \* 2.5 \* 11mm with internal Spring Clip and Locking Notch or Equal, Ferrite: Core: RH 14.2\*28.5\*10, GlobTek Black, GT Cord # C3732, Pin Out: Center Positive (+V), symbol compliant with IEC 60417 symbol no. 5926, Blades/Input Cord: R-Series Desktop Insert, Approvals: cULus (12V only); India BIS (5,7.5, 12,18, 19,24,30 and 48V); CB 60335; Fuse 60335; 230V CoC Tier 2; ETL; NRCan (5V only); South Africa; cETLus 60601-1; CB 62368; UKCA; UL 1310; Conforms to 62368-1; Morocco; Korea (21.0V-28.0V Only); NOM (12V only); NOM (5V only); ETL 62368; Malaysia; IRAM; 61558-1; IEC 61558-1; S-Mark 60950; CB 60950; ETL 60950; Class I; RCM; CCC; CB 60601-1; S-Mark IEC/EN 60601-1; EAC; ETL; CE; China RoHS; Level VI; LPS 60950; RoHS; Ukraine; VCCL; WEEE; PSE; PSE; PSE;

Model No. GTM96600-6024-R3A

Part No./Ordering No. RR9LI2500LCPCIMR6B

Rev B

**OUTPUT CORD AND CONNECTOR: LCL/C3732**

ACTUAL CONNECTORS, OVERMOLDS, FERRITES MAY VARY SLIGHTLY FROM THE PICTURE BELOW

CABLE TYPE	UL 1185
CABLE LENGTH (mm)	1500
CABLE TOLERANCE (mm)	+150, -0
WIRE GAUGE (AWG)	18
CONDUCTORS	1C + Shield
HANK DIMENSION (mm)	80 ± 10
CABLE / CONNECTOR OVERMOLD COLOR	GlobTek Black
FERRITE TYPE AND DIMENSION	Core: RH 14.2*28.5*10
FERRITE NUMBER OF TURNS(Definition)	2 Pass thru core (1 turns)
FERRITE DIMENSION FROM STRAIN RELIEF	50 ± 10
FERRITE DIMENSION FROM PLUG	N/A
PLUG TYPE	Female Barrel 5.5 * 2.5 * 11mm with internal Spring Clip and Locking Notch or Equal
OUTPUT CONNECTOR GENDER	Female
OVERMOLDED	Yes
OVER MOLD ORIENTATION	Straight
CONNECTOR PIN OUT	Center Positive (+V), symbol compliant with IEC 60417 symbol no. 5926

ADDITIONAL REQUIREMENTS  
 UL1310 Warning Label Up To 36 Volts with plugs

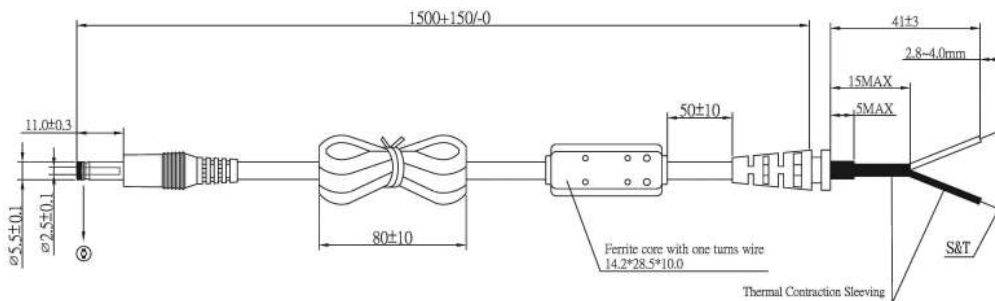

ADDITIONAL OUTPUT PLUG OPTIONS ARE AVAILABLE AT <https://www.globtek.com/connectors/>  
 STANDARD PLUGS AND CONNECTORS CAN BE SEEN ONLINE AT <https://www.globtek.com/connectors/>  
 CALCULATE VOLTAGE REGULATION/DROP WITH OUR ONLINE CALCULATOR: <https://en.globtek.com/output-cable-regulation-calculator/>

<p>GlobTek, Inc. www.globtek.com 186 Veterans Drive, Northvale, NJ 07647 Tel. (201) 784-1000 Fax (201) 784-0111</p>	<p>Drawing Title: GTM96600-6024-R3A, ICT / ITE / Medical Power Supply/Class 2/Household Power Supply, Efficiency Level: USA DOE Level VI / Eco-design Directive 2009/125/EC, (EU) 2019/1782, Case Color/Style: GlobTek Black, Wall Plug-in+Desktop Combination, Regulated Switchmode AC-DC Power Supply AC Adaptor, Input Rating: 100-240V~, 50-60 Hz, IEC 60320/C6 w/ Wall Blades Option , Output Rating: 60W, 24.0V@2.5A, Output Configuration: 1500 mm, 18/1C + Shield Cond, UL 1185, Female Barrel 5.5 * 2.5 * 11mm with internal Spring Clip and Locking Notch or Equal, Ferrite: Core: RH 14.2*28.5*10, GlobTek Black, GT Cord # C3732, Pin Out: Center Positive (+V), symbol compliant with IEC 60417 symbol no. 5926, Blades/Input Cord: R-Series Desktop Insert, Approvals: cULus (12V only); India BIS (5,7.5, 12,18, 19,24,30 and 48V); CB 60335; Fuse 60335; 230V CoC Tier 2; ETL; NRCAN (5V only); South Africa; cETLus 60601-1; CB 62368; UKCA; UL 1310; Conforms to 62368-1; Morocco; Korea (21.0V-28.0V Only); NOM (12V only); NOM (5V only); ETL 62368; Malaysia; IRAM; 61558-1; IEC 61558-1; S-Mark 60950; CB 60950; ETL 60950; Class I; RCM; CCC; CB 60601-1; S-Mark IEC/EN 60601-1; EAC; ETL; CE; China RoHS; Level VI; LPS 60950; RoHS; Ukraine; VCCI; WEEE; PSE; PSE; PSE;</p>	
	<p>Model No. GTM96600-6024-R3A</p>	
	<p>Part No./Ordering No. RR9LI2500LCPCIMR6B</p>	<p>Rev B</p>

**OUTPUT CONNECTOR HOOK UP**

TO ADDRESS SYSTEM-LEVEL EMI CONCERNS, FERRITE CHOKES/BEADS MAY BE ADDED/REVISED UPON REQUEST. A SAMPLE KIT OF GLOBTEK'S STANDARD FERRITES IS AVAILABLE UNDER GLOBTEK P/N: EMI-MITIGATION-KIT1

FOR ADDITIONAL INFORMATION, PLEASE READ OUR WHITE PAPER AT:

<https://en.globtek.com/technical-articles/ferrite-kit-radiated-emi-suppression-kit-for-globtek-power-supplies-cable-assemblies>

<b>GlobTek, Inc.</b> www.globtek.com 186 Veterans Drive, Northvale, NJ 07647 Tel. (201) 784-1000 Fax (201) 784-0111	Drawing Title: GTM96600-6024-R3A, ICT / ITE / Medical Power Supply/Class 2/Household Power Supply, Efficiency Level: USA DOE Level VI / Eco-design Directive 2009/125/EC, (EU) 2019/1782, Case Color/Style: GlobTek Black, Wall Plug-in+Desktop Combination, Regulated Switchmode AC-DC Power Supply AC Adaptor, Input Rating: 100-240V~, 50-60 Hz, IEC 60320/C6 w/ Wall Blades Option , Output Rating: 60W, 24.0V@2.5A, Output Configuration: 1500 mm, 18/1C + Shield Cond, UL 1185, Female Barrel 5.5 * 2.5 * 11mm with internal Spring Clip and Locking Notch or Equal, Ferrite: Core: RH 14.2*28.5*10, GlobTek Black, GT Cord # C3732, Pin Out: Center Positive (+V), symbol compliant with IEC 60417 symbol no. 5926, Blades/Input Cord: R-Series Desktop Insert, Approvals: cULus (12V only); India BIS (5,7.5, 12,18, 19,24,30 and 48V); CB 60335; Fuse 60335; 230V CoC Tier 2; ETL; NRCAN (5V only); South Africa; cETLus 60601-1; CB 62368; UKCA; UL 1310; Conforms to 62368-1; Morocco; Korea (21.0V-28.0V Only); NOM (12V only); NOM (5V only); ETL 62368; Malaysia; IRAM; 61558-1; IEC 61558-1; S-Mark 60950; CB 60950; ETL 60950; Class I; RCM; CCC; CB 60601-1; S-Mark IEC/EN 60601-1; EAC; ETL; CE; China RoHS; Level VI; LPS 60950; RoHS; Ukraine; VCCI; WEEE; PSE; PSE; PSE;	
	Model No. GTM96600-6024-R3A	
	Part No./Ordering No. RR9LI2500LCPCIMR6B	Rev B

**LABEL:L-1470**

LABEL P/N	ISO 15223 medical device compliant label
MATERIAL	Flat Thermal Transfer, Imprintable, Polyester Label and/or Pad Printed and/or Molded, and/or Laser Engraved in the case
BACKGROUND COLOR	Black if housing is Black, White or Silver if housing is White or Gray.
TEXT COLOR	White or Silver if label is Black Background for Black housing. Black if label is White or Silver background and Housing is White or Gray.
LABEL WIDTH (mm)	44.5
LABEL HEIGHT (mm)	49.5
SPECIAL BARCODE LABEL MATERIAL	No

Below is the minimum information which will appear on the label. NOTE: in the logo area additional/actual positioning of symbols and text is subjected to change as per agency updates/requirements or additional model approvals become available.

Agency logos may be in Regulatory Certifications/Label Markings area on the label or molded into the case housing outside the label area. Information will be shown via Label and/or Pad Printed and/or Molded in the case.

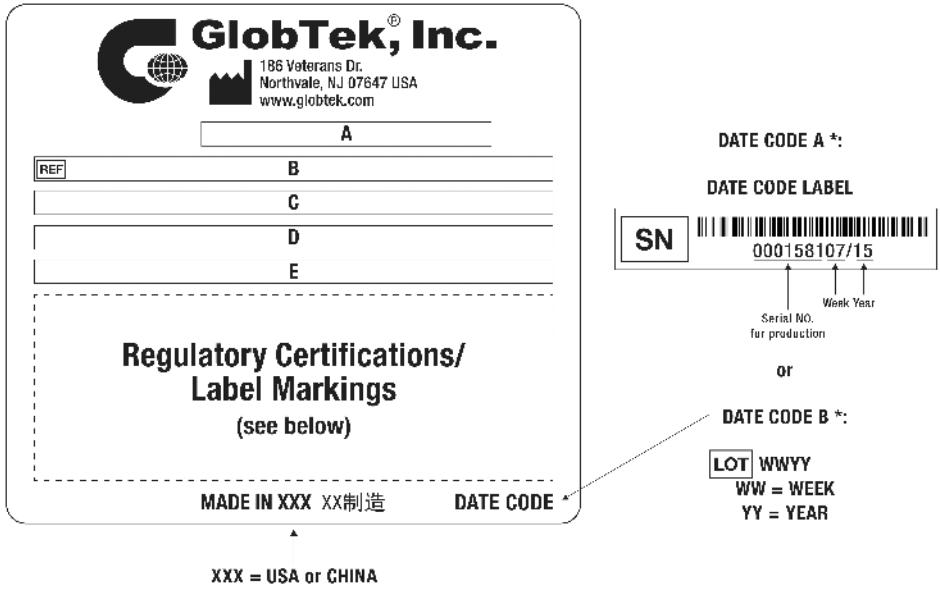

- A=ICT / ITE / Medical Power Supply/Class 2/Household Power Supply
- B=P/N: (料号) RR9LI2500LCPCIMR6B
- C=Model (型号) GTM96600-6024-R3A
- D=Input (输入)100-240V~, 50-60 Hz, 1.5 A
- E=Output (输出)24.0 V 2.5 A, 60.00W



<b>GlobTek, Inc.</b> www.globtek.com 186 Veterans Drive, Northvale, NJ 07647 Tel. (201) 784-1000 Fax (201) 784-0111	Drawing Title: GTM96600-6024-R3A, ICT / ITE / Medical Power Supply/Class 2/Household Power Supply, Efficiency Level: USA DOE Level VI / Eco-design Directive 2009/125/EC, (EU) 2019/1782, Case Color/Style: GlobTek Black, Wall Plug-in+Desktop Combination, Regulated Switchmode AC-DC Power Supply AC Adaptor, Input Rating: 100-240V~, 50-60 Hz, IEC 60320/C6 w/ Wall Blades Option , Output Rating: 60W, 24.0V@2.5A, Output Configuration: 1500 mm, 18/1C + Shield Cond, UL 1185, Female Barrel 5.5 * 2.5 * 11mm with internal Spring Clip and Locking Notch or Equal, Ferrite: Core: RH 14.2*28.5*10, GlobTek Black, GT Cord # C3732, Pin Out: Center Positive (+V), symbol compliant with IEC 60417 symbol no. 5926, Blades/Input Cord: R-Series Desktop Insert, Approvals: cULus (12V only); India BIS (5,7.5, 12,18, 19,24,30 and 48V); CB 60335; Fuse 60335; 230V CoC Tier 2; ETL; NRCAN (5V only); South Africa; cETLus 60601-1; CB 62368; UKCA; UL 1310; Conforms to 62368-1; Morocco; Korea (21.0V-28.0V Only); NOM (12V only); NOM (5V only); ETL 62368; Malaysia; IRAM; 61558-1; IEC 61558-1; S-Mark 60950; CB 60950; ETL 60950; Class I; RCM; CCC; CB 60601-1; S-Mark IEC/EN 60601-1; EAC; ETL; CE; China RoHS; Level VI; LPS 60950; RoHS; Ukraine; VCCI; WEEE; PSE; PSE; PSE;	
	Model No. GTM96600-6024-R3A	
	Part No./Ordering No. RR9LI2500LCPCIMR6B	Rev B

AGENCY ONLINE DOCUMENTS	<a href="http://www.globtek.info/certs/GTM96600-TZ/">http://www.globtek.info/certs/GTM96600-TZ/</a>
CE EC-Declaration for Medical	<a href="http://globtek.force.com/models/ec_declaration_product?id=01ta0000007dRGx&amp;m=1">http://globtek.force.com/models/ec_declaration_product?id=01ta0000007dRGx&amp;m=1</a>
CE EC-Declaration for Industrial/Commercial/ITE	<a href="http://globtek.force.com/models/ec_declaration_product?id=01ta0000007dRGx&amp;i=2">http://globtek.force.com/models/ec_declaration_product?id=01ta0000007dRGx&amp;i=2</a>
CE EC-Declaration for Household	<a href="http://globtek.force.com/models/ec_declaration_product?id=01ta0000007dRGx&amp;h=2">http://globtek.force.com/models/ec_declaration_product?id=01ta0000007dRGx&amp;h=2</a>
UKCA-Declaration for Medical	<a href="http://globtek.force.com/models/ukca_declaration_product?id=01ta0000007dRGx&amp;m=1">http://globtek.force.com/models/ukca_declaration_product?id=01ta0000007dRGx&amp;m=1</a>
UKCA-Declaration for Industrial/Commercial/ITE	<a href="http://globtek.force.com/models/ukca_declaration_product?id=01ta0000007dRGx&amp;i=2">http://globtek.force.com/models/ukca_declaration_product?id=01ta0000007dRGx&amp;i=2</a>
UKCA-Declaration for Household	<a href="http://globtek.force.com/models/ukca_declaration_product?id=01ta0000007dRGx&amp;h=2">http://globtek.force.com/models/ukca_declaration_product?id=01ta0000007dRGx&amp;h=2</a>
Morocco SDoC Declaration	<a href="https://globtek.secure.force.com/models/Morocco_SDoC_Declaration?id=a0Oa000000Mmj3wEAB">https://globtek.secure.force.com/models/Morocco_SDoC_Declaration?id=a0Oa000000Mmj3wEAB</a>
RoHS/RoHS3 Declaration	<a href="https://www.globtek.com/pdf/rohs_cert/01ta0000007dRGxAAM">https://www.globtek.com/pdf/rohs_cert/01ta0000007dRGxAAM</a>
REACH Declaration	<a href="https://www.globtek.com/pdf/iso_certificates/REACH.pdf">https://www.globtek.com/pdf/iso_certificates/REACH.pdf</a>
Conflict Minerals Declaration	<a href="https://www.globtek.com/pdf/conflict-minerals.pdf">https://www.globtek.com/pdf/conflict-minerals.pdf</a>
Prop 65 Statement	<a href="https://en.globtek.com/prop-65-statement.pdf">https://en.globtek.com/prop-65-statement.pdf</a>

IPXY rating is based on 3rd party testing and customers should check suitability and test system level IPXY rating before ordering.

## Regulatory Certifications/Label Markings

Below follows a link to the latest regulatory certifications and marks for this specific product. National standards as well as certification schemes are constantly changing and so is the set of certification marks and symbols applicable to this product. Various standards, marks and symbols, and certificates are subject to change at any time without notice.

Additional standards or unique country certifications are available upon request. Please contact Globtek to request a quotation.

LATEST PRODUCT/MODEL CERTIFICATIONS: <https://www.globtek.com/datasheet/w71109>

AGENCY ONLINE DOCUMENTS <http://www.globtek.info/certs/GTM96600-TZ/>



(E1) Earthed output

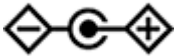

Center Positive (+V), symbol compliant with IEC 60417 symbol no. 5926

<b>GlobTek, Inc.</b> www.globtek.com 186 Veterans Drive, Northvale, NJ 07647 Tel. (201) 784-1000 Fax (201) 784-0111	Drawing Title: GTM96600-6024-R3A, ICT / ITE / Medical Power Supply/Class 2/Household Power Supply, Efficiency Level: USA DOE Level VI / Eco-design Directive 2009/125/EC, (EU) 2019/1782, Case Color/Style: GlobTek Black, Wall Plug-in+Desktop Combination, Regulated Switchmode AC-DC Power Supply AC Adaptor, Input Rating: 100-240V~, 50-60 Hz, IEC 60320/C6 w/ Wall Blades Option , Output Rating: 60W, 24.0V@2.5A, Output Configuration: 1500 mm, 18/1C + Shield Cond, UL 1185, Female Barrel 5.5 * 2.5 * 11mm with internal Spring Clip and Locking Notch or Equal, Ferrite: Core: RH 14.2*28.5*10, GlobTek Black, GT Cord # C3732, Pin Out: Center Positive (+V), symbol compliant with IEC 60417 symbol no. 5926, Blades/Input Cord: R-Series Desktop Insert, Approvals: cULus (12V only); India BIS (5,7.5, 12,18, 19,24,30 and 48V); CB 60335; Fuse 60335; 230V CoC Tier 2; ETL; NRCAN (5V only); South Africa; cETLus 60601-1; CB 62368; UKCA; UL 1310; Conforms to 62368-1; Morocco; Korea (21.0V-28.0V Only); NOM (12V only); NOM (5V only); ETL 62368; Malaysia; IRAM; 61558-1; IEC 61558-1; S-Mark 60950; CB 60950; ETL 60950; Class I; RCM; CCC; CB 60601-1; S-Mark IEC/EN 60601-1; EAC; ETL; CE; China RoHS; Level VI; LPS 60950; RoHS; Ukraine; VCCI; WEEE; PSE; PSE; PSE;	
	Model No. GTM96600-6024-R3A	
	Part No./Ordering No. RR9LI2500LCPCIMR6B	Rev B

## PACKAGING

Packing Spec P/N	Standard DT, Cellular packaging, User manual
Box Qty	60
Gift Box Size (mm)	142*62*60
Gift Box Color	White
Master Carton Size (mm)	442 x 330 x 275
Master Carton Cubic Volume (m <sup>3</sup> )	0.04
Master GW (Kg)	20.3 kg
BLADES INCLUDED	R-DI: R-Series Desktop Insert
BLADE/CORD INSTALLED	R-DI: R-Series Desktop Insert
USER MANUAL*	809-DESKTOPUSERMANUAL on A4 paper
USER MANUAL WEB LINK	<a href="https://en.globtek.com/pdf/809-DESKTOPUSERMANUAL.jpg">https://en.globtek.com/pdf/809-DESKTOPUSERMANUAL.jpg</a>

\* This specification sheet is considered the user manual for all applications. It is expected that the buyer of this product will use it to formulate their own user manual for their end product and a user manual specifically for the power adapter is not usually required. If a user manual is not specifically listed above then none will be provided with this unit.

If specific packaging is required, this section must specify all requirements and note "no exceptions". If this section does not specify packaging, it is subject to change without notice at GlobTek's discretion.

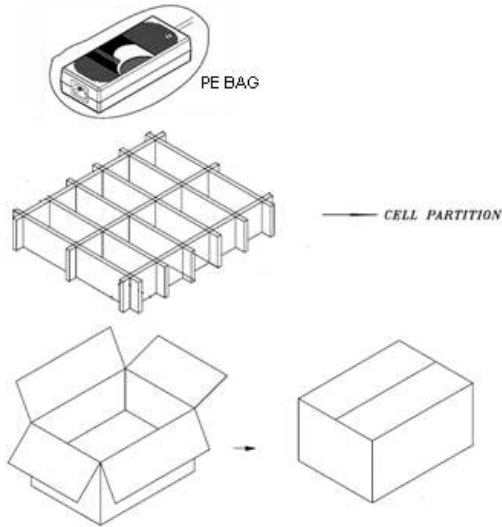

<p>GlobTek, Inc. www.globtek.com 186 Veterans Drive, Northvale, NJ 07647 Tel. (201) 784-1000 Fax (201) 784-0111</p>	<p>Drawing Title: GTM96600-6024-R3A, ICT / ITE / Medical Power Supply/Class 2/Household Power Supply, Efficiency Level: USA DOE Level VI / Eco-design Directive 2009/125/EC, (EU) 2019/1782, Case Color/Style: GlobTek Black, Wall Plug-in+Desktop Combination, Regulated Switchmode AC-DC Power Supply AC Adaptor, Input Rating: 100-240V~, 50-60 Hz, IEC 60320/C6 w/ Wall Blades Option , Output Rating: 60W, 24.0V@2.5A, Output Configuration: 1500 mm, 18/1C + Shield Cond, UL 1185, Female Barrel 5.5 * 2.5 * 11mm with internal Spring Clip and Locking Notch or Equal, Ferrite: Core: RH 14.2*28.5*10, GlobTek Black, GT Cord # C3732, Pin Out: Center Positive (+V), symbol compliant with IEC 60417 symbol no. 5926, Blades/Input Cord: R-Series Desktop Insert, Approvals: cULus (12V only); India BIS (5,7.5, 12,18, 19,24,30 and 48V); CB 60335; Fuse 60335; 230V CoC Tier 2; ETL; NRCAN (5V only); South Africa; cETLus 60601-1; CB 62368; UKCA; UL 1310; Conforms to 62368-1; Morocco; Korea (21.0V-28.0V Only); NOM (12V only); NOM (5V only); ETL 62368; Malaysia; IRAM; 61558-1; IEC 61558-1; S-Mark 60950; CB 60950; ETL 60950; Class I; RCM; CCC; CB 60601-1; S-Mark IEC/EN 60601-1; EAC; ETL; CE; China RoHS; Level VI; LPS 60950; RoHS; Ukraine; VCCI; WEEE; PSE; PSE; PSE;</p>		
	<table border="1"> <tr> <td data-bbox="300 378 1380 459"> <p>Model No. GTM96600-6024-R3A</p> <p>Part No./Ordering No. RR9LI2500LCPCIMR6B</p> </td> <td data-bbox="1380 378 1550 459"> <p>Rev B</p> </td> </tr> </table>	<p>Model No. GTM96600-6024-R3A</p> <p>Part No./Ordering No. RR9LI2500LCPCIMR6B</p>	<p>Rev B</p>
<p>Model No. GTM96600-6024-R3A</p> <p>Part No./Ordering No. RR9LI2500LCPCIMR6B</p>	<p>Rev B</p>		

## INSTRUCTIONS TO THE OEM SYSTEMS ENGINEER

It is the responsibility of the OEM systems engineer to provide the end system user instructions and warnings for the use of this product in the end system.

If an input cord is required for this product, AC Mains voltage should be provided to the power supply by a power supply cord approved to the national standards of the country in which it will be used.

This product is not designed to be repaired. No serviceable parts inside. A blown internal fuse is an indication of catastrophic failure of circuit component(s). If a Failure Analysis is required for a failed power supply/battery charger, please return the damaged unit to GlobTek for an accurate determination of the root cause of the failure.

EMC Compliance of the complete OEM product, including the GlobTek power supply/battery charger needs to be verified by the OEM systems engineer.

## INSTRUCTION SHEET

N/A

<p>GlobTek, Inc.  www.globtek.com  186 Veterans Drive,  Northvale, NJ 07647  Tel. (201) 784-1000  Fax (201) 784-0111</p>	<p>Drawing Title: GTM96600-6024-R3A, ICT / ITE / Medical Power Supply/Class 2/Household Power Supply, Efficiency Level: USA DOE Level VI / Eco-design Directive 2009/125/EC, (EU) 2019/1782, Case Color/Style: GlobTek Black, Wall Plug-in+Desktop Combination, Regulated Switchmode AC-DC Power Supply AC Adaptor, Input Rating: 100-240V~, 50-60 Hz, IEC 60320/C6 w/ Wall Blades Option , Output Rating: 60W, 24.0V@2.5A, Output Configuration: 1500 mm, 18/1C + Shield Cond, UL 1185, Female Barrel 5.5 * 2.5 * 11mm with internal Spring Clip and Locking Notch or Equal, Ferrite: Core: RH 14.2*28.5*10, GlobTek Black, GT Cord # C3732, Pin Out: Center Positive (+V), symbol compliant with IEC 60417 symbol no. 5926, Blades/Input Cord: R-Series Desktop Insert, Approvals: cULus (12V only); India BIS (5,7.5, 12,18, 19,24,30 and 48V); CB 60335; Fuse 60335; 230V CoC Tier 2; ETL; NRCAN (5V only); South Africa; cETLus 60601-1; CB 62368; UKCA; UL 1310; Conforms to 62368-1; Morocco; Korea (21.0V-28.0V Only); NOM (12V only); NOM (5V only); ETL 62368; Malaysia; IRAM; 61558-1; IEC 61558-1; S-Mark 60950; CB 60950; ETL 60950; Class I; RCM; CCC; CB 60601-1; S-Mark IEC/EN 60601-1; EAC; ETL; CE; China RoHS; Level VI; LPS 60950; RoHS; Ukraine; VCCI; WEEE; PSE; PSE; PSE;</p>		
	<p>Model No. GTM96600-6024-R3A</p>		
	<table border="1"> <tr> <td data-bbox="300 459 1380 459">Part No./Ordering No. RR9LI2500LCPCIMR6B</td> <td data-bbox="1380 459 1550 459">Rev B</td> </tr> </table>	Part No./Ordering No. RR9LI2500LCPCIMR6B	Rev B
Part No./Ordering No. RR9LI2500LCPCIMR6B	Rev B		

