

EFX1S

Metalized polypropylene film EMI suppression capacitors



Applications

- Class X1 for interference suppression
- EMI filtering in across-the-line applications
- Solar inverter
- UPS
- AC Motor drive
- Air conditioner
- Switch mode power supplies (SMPS)

Product features



- High stability of capacitance
- Self-healing property
- Over voltage stress withstanding
- Flame-retardant plastic case and resin

Environmental compliance and general specifications

- Operating temperature range: -40 °C to +110 °C



Agency information

Approval mark	Standard	File number
	UL 60384-14 CAN/CSA-E60384-14	E529574
	IEC 60384-14:2013 IEC 60384-14:2013/AMD1:2016	40055921
	IEC 60384-14:2013+AMD1:2016 CQC11-471112-2015	CQC22001363199



Powering Business Worldwide

Part number system

EF	X1	S	48	K	103	B01	2L	H
Capacitor type	Family	Grade	Voltage (Vac)	Tolerance	Capacitance (pF)	Size code	Terminal code	Lead length code
EF = film capacitors	X1	S = standard	48 = 480	K = ±10% M = ±20%	First two digits = significant figures, third digit = number of zeros example: 103 = 10000 pF	Refer to size code table	Refer to terminal code table	Refer to lead length code table

Terminal code table

Digit one (Lead/terminal type)	Digit two (Lead Ipsilateral)
Straight cut 2	N/A L
Taping straight V	- -

Lead length code table

Lead length	
3.0±0.5 mm (Bulk)	D
3.5±0.5 mm (Bulk)	E
4.0±0.5 mm (Bulk)	F
4.5±0.5 mm (Bulk)	G
5.0±0.5 mm (Bulk)	H
25±2 mm (Ammo)	T

Dimensions-mm

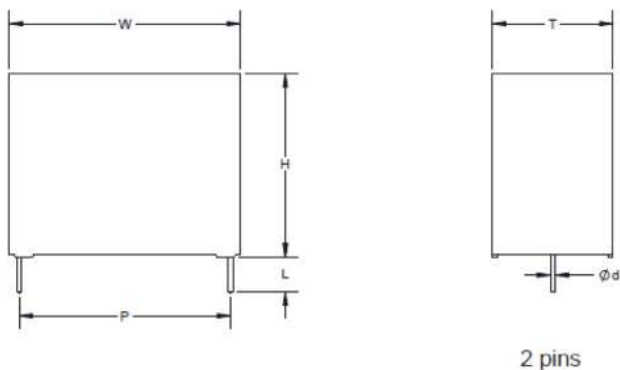

Part marking

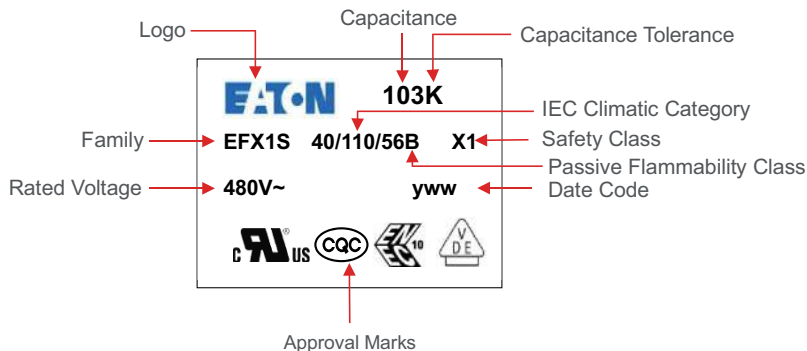

Size code table

Size	Dimension						Pitch		Lead wire		Lead length
	Code	W	Tolerance (±)	H	Tolerance (±)	T	Tolerance (±)	P	Tolerance (±)	Ød	
B01	18	0.5	11	0.5	5	0.5	15	0.5	0.6	0.05	Refer to Lead Length Code Table, Pitch 27.5 and 37.5 without Ammo package
B02	18	0.5	12	0.5	6	0.5	15	0.5	0.6	0.05	
B07	18	0.5	13.5	0.5	7.5	0.5	15	0.5	0.8	0.05	
B11	18	0.5	16	0.5	10	0.5	15	0.5	0.8	0.05	
B16	18	0.5	19	0.5	11	0.5	15	0.5	0.8	0.05	
C01	26	0.5	15.5	0.5	6	0.5	22.5	0.5	0.6	0.05	
C02	26	0.5	16.5	0.5	7	0.5	22.5	0.5	0.8	0.05	
C03	26	0.5	17	0.5	8.5	0.5	22.5	0.5	0.8	0.05	
C05	26	0.5	20	0.5	11	0.5	22.5	0.5	0.8	0.05	
C08	26	0.5	24.5	0.5	13	0.5	22.5	0.5	0.8	0.05	
C09	26	0.5	25	0.5	15	0.5	22.5	0.5	0.8	0.05	
C10	26	0.5	29.5	0.5	14.5	0.5	22.5	0.5	0.8	0.05	
D02	32	0.8	18	0.8	9	0.8	27.5	0.5	0.8	0.05	
D03	32	0.8	20	0.8	11	0.8	27.5	0.5	0.8	0.05	
D04	32	0.8	22	0.8	13	0.8	27.5	0.5	0.8	0.05	
D06	32	0.8	24.5	0.8	13	0.8	27.5	0.5	0.8	0.05	
D08	32	0.8	28	0.8	14	0.8	27.5	0.5	0.8	0.05	
D09	32	0.8	28	0.8	18	0.8	27.5	0.5	0.8	0.05	
D12	32	0.8	33	0.8	18	0.8	27.5	0.5	0.8	0.05	
D13	32	0.8	37	0.8	22	0.8	27.5	0.5	0.8	0.05	
E02	42	1.0	24	1.0	13	1.0	37.5	0.5	1.0	0.05	
E03	42	1.0	26	1.0	15	1.0	37.5	0.5	1.0	0.05	
E07	42	1.0	30	1.0	17	1.0	37.5	0.5	1.0	0.05	
E09	42	1.0	32	1.0	17	1.0	37.5	0.5	1.0	0.05	
E10	42	1.0	32	1.0	19	1.0	37.5	0.5	1.0	0.05	
E11	42	1.0	37	1.0	22	1.0	37.5	0.5	1.0	0.05	
E14	42	1.0	43	1.0	28	1.0	37.5	0.5	1.0	0.05	
E15	42	1.0	44	1.0	24	1.0	37.5	0.5	1.0	0.05	
E16	42	1.0	45	1.0	30	1.0	37.5	0.5	1.0	0.05	
F03	57.5	1.0	50	1.0	35	1.0	52.5	0.5	1.2	0.05	

P=15/22.5 case color is gray, P=27.5/37.5 case color is black.

Rating and part number

Rated voltage 480 Vac/1000 Vdc

Capacitance value (μF)	Dimensions				Peak current (A)	Surge current (A)	dv/dt (V/μs)	Part number ¹
	W (mm)	H (mm)	T (mm)	P (mm)				
0.01	18	11	5	15	6	18	600	EFX1S48K103B012LH
0.015	18	11	5	15	9	27	600	EFX1S48K153B012LH
0.018	18	11	5	15	10.8	32.4	600	EFX1S48K183B012LH
0.022	18	11	5	15	13.2	39.6	600	EFX1S48K223B012LH
0.033	18	11	5	15	19.8	59.4	600	EFX1S48K333B012LH
0.047	18	12	6	15	28.2	84.6	600	EFX1S48K473B022LH
0.068	18	13.5	7.5	15	40.8	122.4	600	EFX1S48K683B072LH
0.1	18	16	10	15	60	180	600	EFX1S48K104B112LH
0.15	18	19	11	15	90	270	600	EFX1S48K154B162LH
0.047	26	15.5	6	22.5	14.1	42.3	300	EFX1S48K473C012LH
0.056	26	15.5	6	22.5	16.8	50.4	300	EFX1S48K563C012LH
0.068	26	15.5	6	22.5	20.4	61.2	300	EFX1S48K683C012LH
0.082	26	15.5	6	22.5	24.6	73.8	300	EFX1S48K823C012LH
0.1	26	15.5	6	22.5	30	90	300	EFX1S48K104C012LH
0.15	26	16.5	7	22.5	45	135	300	EFX1S48K154C022LH
0.22	26	17	8.5	22.5	66	198	300	EFX1S48K224C032LH
0.33	26	20	11	22.5	99	297	300	EFX1S48K334C052LH
0.47	26	24.5	13	22.5	141	423	300	EFX1S48K474C082LH
0.56	26	25	15	22.5	168	504	300	EFX1S48K564C092LH
0.68	26	29.5	14.5	22.5	204	612	300	EFX1S48K684C102LH
0.15	32	18	9	27.5	30	90	200	EFX1S48K154D022LH
0.22	32	18	9	27.5	44	132	200	EFX1S48K224D022LH
0.33	32	18	9	27.5	66	198	200	EFX1S48K334D022LH
0.47	32	20	11	27.5	94	282	200	EFX1S48K474D032LH
0.56	32	22	13	27.5	112	336	200	EFX1S48K564D042LH
0.68	32	24.5	13	27.5	136	408	200	EFX1S48K684D062LH
0.82	32	28	14	27.5	164	492	200	EFX1S48K824D082LH
1.0	32	28	18	27.5	200	600	200	EFX1S48K105D092LH
1.2	32	33	18	27.5	240	720	200	EFX1S48K125D122LH
1.5	32	33	18	27.5	300	900	200	EFX1S48K155D122LH
1.8	32	37	22	27.5	360	1080	200	EFX1S48K185D132LH
0.47	42	24	13	37.5	70.5	211.5	150	EFX1S48K474E022LH
0.56	42	24	13	37.5	84	252	150	EFX1S48K564E022LH
0.68	42	24	13	37.5	102	306	150	EFX1S48K684E022LH
0.82	42	24	13	37.5	123	369	150	EFX1S48K824E022LH
1.0	42	24	13	37.5	150	450	150	EFX1S48K105E022LH
1.2	42	26	15	37.5	180	540	150	EFX1S48K125E032LH
1.5	42	30	17	37.5	225	675	150	EFX1S48K155E072LH

1. Standard part numbers listed---addition configurations available for tolerance, terminal and lead length. See part number system for available tolerances and terminal and lead length tables for available options.

Rating and part number

Rated voltage 480 Vac/1000 Vdc

Capacitance value (μF)	Dimensions				Peak current (A)	Surge current (A)	dv/dt (V/μs)	Part number ¹
	W (mm)	H (mm)	T (mm)	P (mm)				
1.8	42	32	17	37.5	270	810	150	EFX1S48K185E092LH
2.2	42	32	19	37.5	330	990	150	EFX1S48K225E102LH
2.7	42	37	22	37.5	405	1215	150	EFX1S48K275E112LH
3.3	42	44	24	37.5	495	1485	150	EFX1S48K335E152LH
3.9	42	43	28	37.5	585	1755	150	EFX1S48K395E142LH
4.7	42	45	30	37.5	705	2115	150	EFX1S48K475E162LH
5.6	57.5	50	35	52.5	504	1512	90	EFX1S48K565F032LH

1. Standard part numbers listed--addition configurations available for tolerance, terminal and lead length. See part number system for available tolerances and terminal and lead length tables for available options.

General information

Application	Interference suppression \ Across-the-line (Class X1)
Dielectric	Metallized Polypropylene Film
Reference standard	IEC 60384-14; UL 60384-14; GB/T 6346.14-2015
Climatic category	40/110/56 IEC60068-1
Passive flammability class	B
Operating temperature range	-40 °C to +110 °C
Protection	Solvent resistant plastic case UL94 V-0, Thermosetting resin sealing UL 94V-0 compliant
Installation	Any position
Packaging	Packed in cardboard boxes with protection for the terminals
Storage conditions	Storage time: ≤24 months from the date marked on the package label, Average relative humidity per year ≤70%, RH≤85% for 30 days in one year, Dew is absent, Temperature: -40°C to +85°C
RoHS compliant	Compliant with the restricted substance requirements of Directive 2011/65/EU
Flame retardant grade	Flame retardant performance accords with horizontal combustion grade HB and vertical combustion grade V-0

Construction

Metallized film	OPP & Al/Zn
Metal sprayed	Sn/Zn Alloy
Connection electrode	(0.6 mm to 0.8 mm) Tinned copper clad steel wire (1.0 mm to 1.2 mm) Tinned copper wires
Plastic case	Plastic case (UL94V-0)
Filling	Epoxy resin (UL94V-0) Internal series connection

Film construction

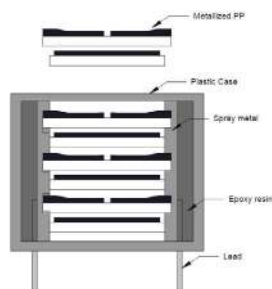

Electrical and general characteristics

Rated AC voltage (U_R)	480 Vac 50/60 Hz
Recommended DC voltage	1000 Vdc
Capacitance range	0.01 μ F to 5.6 μ F
Capacitance tolerance	$\pm 10\%$ or $\pm 20\%$ at $+20^\circ\text{C}$
Capacitance	Measuring Frequency at 1 kHz, $+20^\circ\text{C}$ Measuring Voltage: 1.0 ± 0.2 V
Standard atmospheric conditions for static test	Ambient temperature $+15^\circ\text{C}$ to $+35^\circ\text{C}$ Relative humidity 45% to 75% Air pressure 86 kPa to 106 kPa.
Withstanding DC voltage between terminals U_{TR}	DC Voltage: $4.3 \times U_R^*$ for 60 seconds (at $+20 \pm 2^\circ\text{C}$) *The U_R in this DC test is the rated AC voltage value
Withstanding AC voltage between terminal and case U_{TC}	$2U_R + 1500$ Vac, 60 s (at $+20 \pm 2^\circ\text{C}$)
Dissipation factor	$\leq 20 \times 10^{-4}$ at 10 kHz, ($C \leq 1 \mu\text{F}$) at $+20^\circ\text{C}$ $\leq 30 \times 10^{-4}$ at 1 kHz, ($C > 1 \mu\text{F}$) at $+20^\circ\text{C}$
Insulation resistance	R between leads, for $C \leq 0.33 \mu\text{F}$ at 100 V 20°C ; 1 min $> 15\,000 \text{ M}\Omega$ RC between leads, for $C > 0.33 \mu\text{F}$ at 100 V 20°C ; 1 min $> 5000 \text{ M}\Omega \cdot \mu\text{F}$
Life expectancy	100,000 hours (U_R) hotspot = $+85^\circ\text{C}$ ($\Delta C/C \leq 10\%$)
Failure rate	100 FIT
Maximum altitude	2000 m

Charcteristics curves

Maximum voltage (V_{rms}) vs frequency

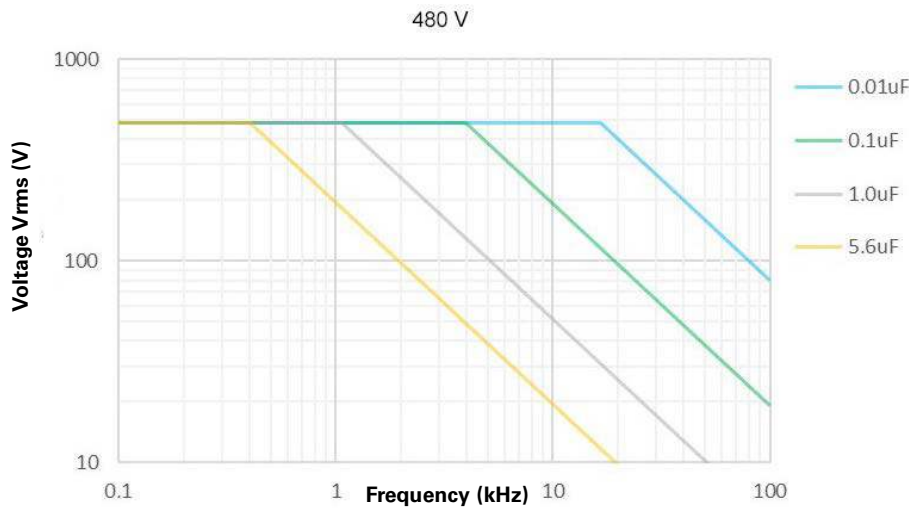

Maximum current (I_{rms}) vs frequency

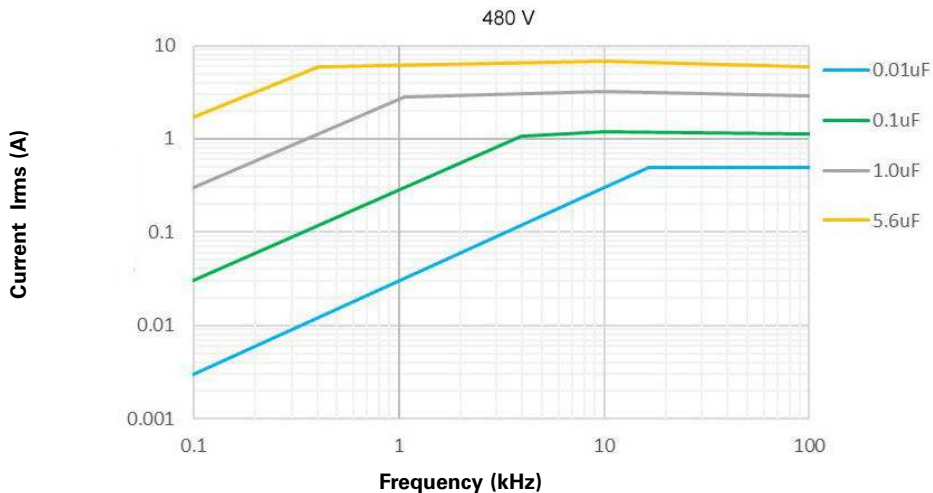

Characteristics curves

Expected life curve

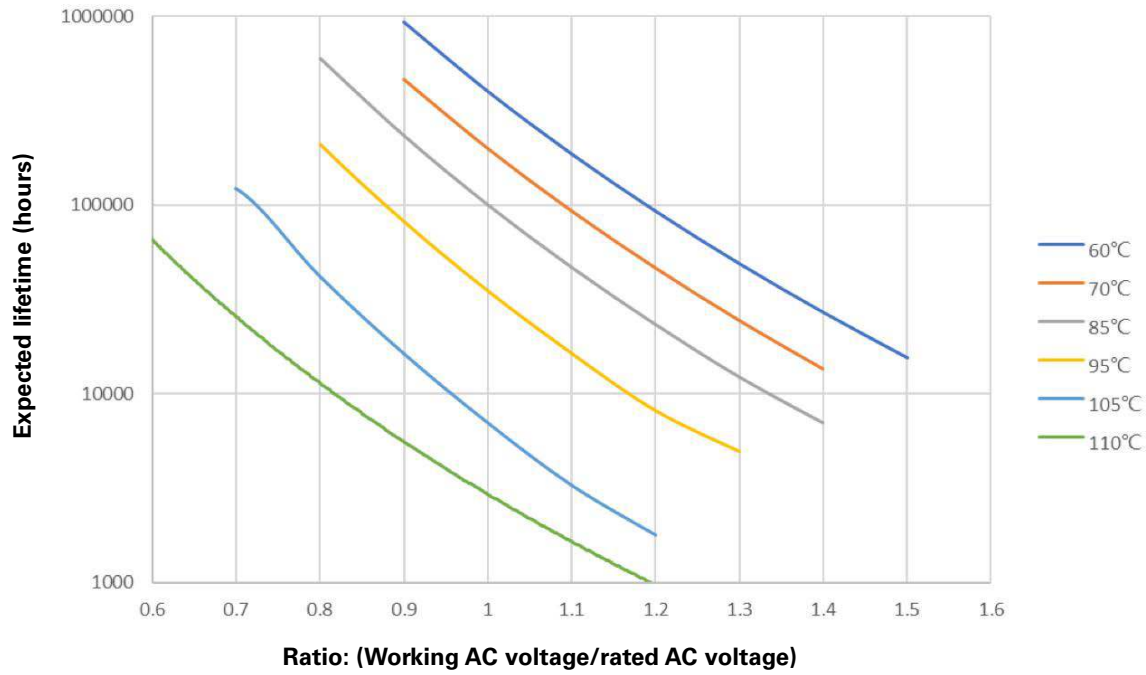

Impedance vs frequency

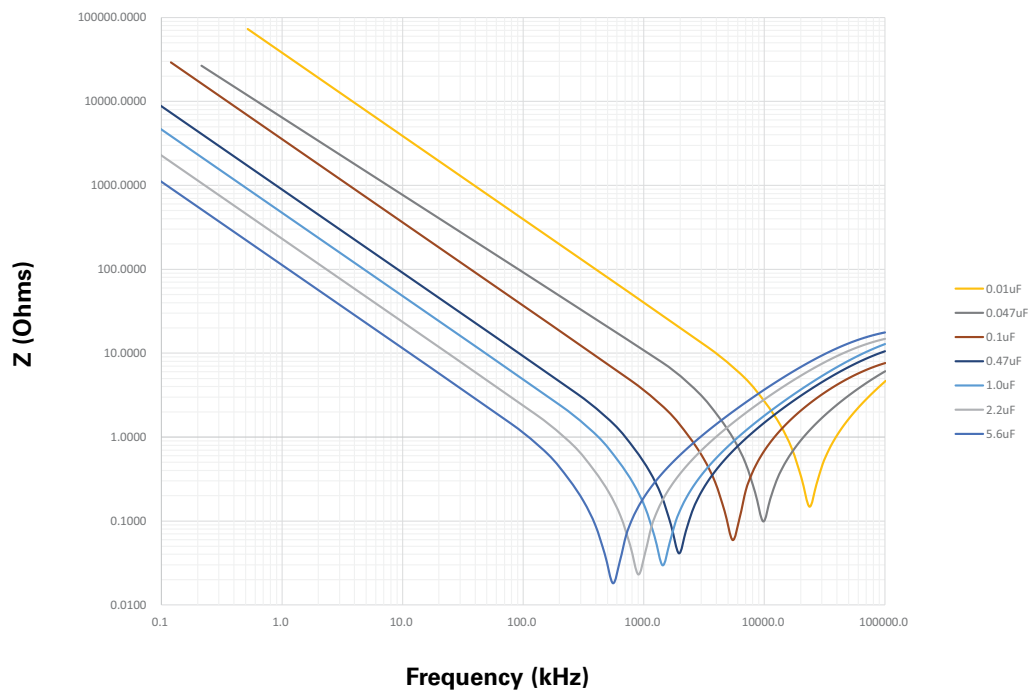

Environmental test

Test	Test condition	Performance
Damp heat loading	Test temperature: +40 ±2 °C Test humidity: 90% to 95% R.H. Test Duration: 1000 +24/-0 hours Loading voltage: Rated voltage	Capacitance change rate (ΔC/C) : ≤±10% DF change (Δtgδ) : ≤80*10 ⁻⁴ at 10 kHz. (C ≤ 1 μF) DF change (Δtgδ) : ≤50 * 10 ⁻⁴ at 1 kHz. (C > 1 μF) Insulation resistance: ≥50% of initial limit (T-T) test voltage: 4.3 U _R (dc)/60 s (T-C) test voltage: 2 U _R + 1500 V (ac)/60 s
Rapid temperature change	Testing method per IEC 60068-2-14 Na Test temperature cycle: Total 5 cycles High temperature: +110 ±5 °C for 30 minutes Low temperature: -40 ±5 °C for 30 minutes	Capacitance change rate (ΔC/C) : ≤±5% DF change (Δtgδ) : ≤80*10 ⁻⁴ at 10 kHz. (C ≤ 1 μF) DF change (Δtgδ) : ≤50*10 ⁻⁴ at 1 kHz. (C > 1 μF) Insulation resistance: ≥50% of initial limit (T-T) test voltage: 4.3 U _R (dc)/60 s (T-C) test voltage: 2 U _R + 1500 V (ac)/60 s
High temperature loading	Testing method per IEC 60384-14 Test Temperature: +110 ±2 °C. Apply 125% of rated voltage for 1,000 +24/-0 hours; Each of these voltages shall be applied to each capacitor individually through a resistor of 47 Ω ±5%. Once every hour the voltage is increased to 1.5UR or 1000 V rms, whichever is higher, for 0.1 seconds.	Capacitance change rate (ΔC/C) : ≤±10% DF change (Δtgδ) : ≤80*10 ⁻⁴ at 10 kHz. (C ≤ 1 μF) DF change (Δtgδ) : ≤50*10 ⁻⁴ at 1 kHz. (C > 1 μF) Insulation resistance: ≥50% of initial limit (T-T) test voltage: 4.3 U _R (dc)/60 s (T-C) test voltage: 2 U _R + 1500 V (ac)/60 s
High temperature features	Test Temperature: +110 ±2 °C Test Duration: 16 +1/-0 hours	Capacitance change rate (ΔC/C) : -0 to -5% DF change (Δtgδ) : ≤80*10 ⁻⁴ at 10 kHz. (C ≤ 1 μF) DF change (Δtgδ) : ≤50*10 ⁻⁴ at 1 kHz. (C > 1 μF) Insulation resistance: ≥50% of initial limit (T-T) test voltage: 4.3 U _R (dc)/60 s (T-C) test voltage: 2 U _R + 1500 V (ac)/60 s
Low temperature features	Test Temperature: -40 ±2 °C Test Duration: 2 +1/-0 hours	Capacitance change rate (ΔC/C) : +0 to +5% DF change (Δtgδ) : ≤80*10 ⁻⁴ at 10 kHz. (C ≤ 1 μF) DF change (Δtgδ) : ≤50*10 ⁻⁴ at 1 kHz. (C > 1 μF) Insulation resistance: ≥50% of initial limit (T-T) test voltage: 4.3 U _R (dc)/60 s (T-C) test voltage: 2 U _R + 1500 V (ac)/60 s
Solderability	Testing method per IEC 60068-2-20 Ta Soldering temperature: +245 ±5 °C Immersion duration: 2 ±0.5 seconds	More than 95% of circumferential surface of lead wire shall be covered with new solder. Insulation resistance: ≥50% of initial limit (T-T) test voltage: 4.3 U _R (dc)/60 s (T-C) test voltage: 2 U _R + 1500 V (ac) /60 s
Soldering heat resistance	Flow soldering: Preheat temperature +100 °C to +120 °C Preheat duration: 100 seconds maximum Soldering temperature: +260 ±5 °C Immersion duration: ≤10 seconds Immersion depth: 1.5 ± 0.5 mm from roots	Capacitance change rate (ΔC/C): ≤±2% DF change (Δtgδ): ≤80*10 ⁻⁴ at 10 kHz. (C ≤ 1 μF) DF change (Δtgδ): ≤50*10 ⁻⁴ at 1 kHz. (C > 1 μF) Insulation resistance: ≥50% of initial limit (T-T) test voltage: 4.3 U _R (dc)/60 s (T-C) test voltage: 2 U _R + 1500 V (ac) /60 s
Temperature cycle	Test temperature cycle: Total 5 cycles Each cycle includes: 1. +20 ± 2 °C for 3 minutes 2. -40 +0/-3 °C for 30 minutes 3. +20 +/- 2 °C for 3 minutes 4. +110 +3/-0 °C for 30 minutes 5. +20 ± 2 °C for 3 minutes	Capacitance change rate (ΔC/C): ≤±5% DF change (Δtgδ): ≤80*10 ⁻⁴ at 10 kHz. (C ≤ 1 μF) DF change (Δtgδ): ≤50*10 ⁻⁴ at 1 kHz. (C > 1 μF) Insulation resistance: ≥50% of initial limit (T-T) test voltage: 4.3 U _R (dc)/60 s (T-C) test voltage: 2 U _R + 1500 V (ac) /60 s
Humidity resistance	Testing method per IEC 60068-2-3 Ca Test temperature: +40 ±2 °C Test humidity: 90% to 95% R.H. Test duration: 1344 +24/-0 hours	Capacitance change rate (ΔC/C): ≤±5% DF change (Δtgδ): ≤80*10 ⁻⁴ at 10 kHz. (C ≤ 1 μF) DF change (Δtgδ): ≤50*10 ⁻⁴ at 1 kHz. (C > 1 μF) Insulation resistance: ≥50% of initial limit (T-T) test voltage: 4.3 U _R (dc)/60 s (T-C) test voltage: 2 U _R + 1500 V (ac) /60 s

Electrical test

Test	Test condition	Performance
Charge and discharge	10000 cycles Charge to √2 x UR(DC) Charge resistance: $R = \frac{220 \times 10^{-6}}{C_N} \Omega$ Discharge resistance: $R = \frac{\sqrt{2} \times U_R (DC)}{1.25 \times C (dv/dt)} \Omega$	Capacitance change rate (ΔC/C) : ≤±5% DF change (Δtgδ) : ≤80*10 ⁻⁴ at 10 kHz. (C ≤ 1 μF) DF change (Δtgδ) : ≤50 * 10 ⁻⁴ at 1 kHz. (C > 1 μF) Insulation resistance: ≥50% of initial limit (T-T) test voltage: 4.3 U _R (dc)/60 s (T-C) test voltage: 2 U _R + 1500 V (ac)/60 s
Impulse voltage	3 successive impulses, full wave, peak voltage: X1: 4 kV for C ≤ 1 μF X1: 4 kV/√C for C > 1 μF 24 pulses maximum	No self-healing breakdowns or flashover

Mechanical test

Test	Test condition	Performance
Resistance to solvent	IEC 60068-2-45 test XA method 1 Solvent: propanol (isopropyl-alcohol) Temperature: +23 ±5°C Immersion time: 5 ±0.5 minutes Drying time: 5 minutes Mechanical treatment: 10 rubbing (with cotton-wool)	Capacitance change rate ($\Delta C/C$): $\leq \pm 1\%$ DF change ($\Delta tg \delta$): $\leq 80 * 10^{-4}$ at 10 kHz. (C \leq 1 μ F) DF change ($\Delta tg \delta$): $\leq 50 * 10^{-4}$ at 1 kHz. (C > 1 μ F) Insulation resistance: $\geq 50\%$ of initial limit (T-T) test voltage: 4.3 U _R (dc)/60 s (T-C) test voltage: 2 U _R + 1500 V (ac)/60 s
Terminal strength	Tension: 0.50 < D \leq 0.80, 10N 0.80 < D \leq 1.25, 20N Bending test : Bending force: 0.50 < D \leq 0.80, 5N 0.80 < D \leq 1.25, 10N Make two successive bends in each direction	No visible damage to appearance
Vibration resistance	Testing method per IEC 60068-2-6 Fc. Frequency Change: 10—55—10 Hz. Vibration Distance : 1.5 mm Test Direction : X, Y, Z Test Duration: 2 +1/- 0 hours each direction	Capacitance change rate ($\Delta C/C$): $\leq \pm 3\%$ DF change ($\Delta tg \delta$): $\leq 80 * 10^{-4}$ at 10 KHz. (C \leq 1 μ F) DF change ($\Delta tg \delta$): $\leq 50 * 10^{-4}$ at 1 kHz. (C > 1 μ F) Insulation resistance: $\geq 50\%$ of initial limit (T-T) test voltage: 4.3 U _R (dc)/60 s (T-C) test voltage: 2 U _R + 1500 V (ac)/60 s
Bump	1000 times, Acceleration: 400 m/s ² Pulse duration: 6 ms	Capacitance change rate ($\Delta C/C$): $\leq \pm 3\%$ DF change ($\Delta tg \delta$): $\leq 80 * 10^{-4}$ at 10 kHz. (C \leq 1 μ F) DF change ($\Delta tg \delta$): $\leq 50 * 10^{-4}$ at 1 kHz. (C > 1 μ F) Insulation resistance: $\geq 50\%$ of initial limit (T-T) test voltage: 4.3 U _R (dc)/60 s (T-C) test voltage: 2 U _R + 1500 V (ac)/60 s

Flammability test

Test	Test condition	Performance
Passive flammability class B	Bore of gas jet: Ø 0.5 mm Fuel: Butane Test duration for actual volume V in mm3: V \leq 250: 10 s 250 < V \leq 500: 20 s 500 < V \leq 1750: 30 s V > 1750: 60 s One flame application	After removing test flame from capacitor, the capacitor must not continue to burn for more than 10 s. No burning particle must drop from the sample.
Active flammability	20 cycles of 4 kV discharges on the test capacitor connected to U _R	The cheese cloth around the capacitors shall not burn with a flame. No electrical measurements are required.

Packaging information

Pitch mm	Size Code	Dimension			Package quantity	
		W	H	T	Bulk pack/box	Ammo pack/box
15	B01	18	11	5	1,054	680
	B02	18	12	6	867	560
	B07	18	13.5	7.5	697	450
	B11	18	16	10	527	340
	B16	18	19	11	476	300
22.5	C01	26	15.5	6	612	350
	C02	26	16.5	7	528	300
	C03	26	17	8.5	432	250
	C05	26	20	11	336	190
	C08	26	24.5	13	276	160
	C09	26	25	15	240	140
27.5	C10	26	29.5	14.5	252	140
	D02	32	18	9	340	NA
	D03	32	20	11	280	NA
	D04	32	22	13	230	NA
	D06	32	24.5	13	230	NA
	D08	32	28	14	220	NA
	D09	32	28	18	170	NA
37.5	D12	32	33	18	170	NA
	D13	32	37	22	140	NA
	E02	42	24	13	161	NA
	E03	42	26	15	140	NA
	E07	42	30	17	126	NA
	E09	42	32	17	126	NA
	E10	42	32	19	112	NA
	E11	42	37	22	98	NA
52.5	E14	42	43	28	77	NA
	E15	42	44	24	91	NA
	E16	42	45	30	70	NA
	F03	57.5	50	35	45	NA

Wave solder profile

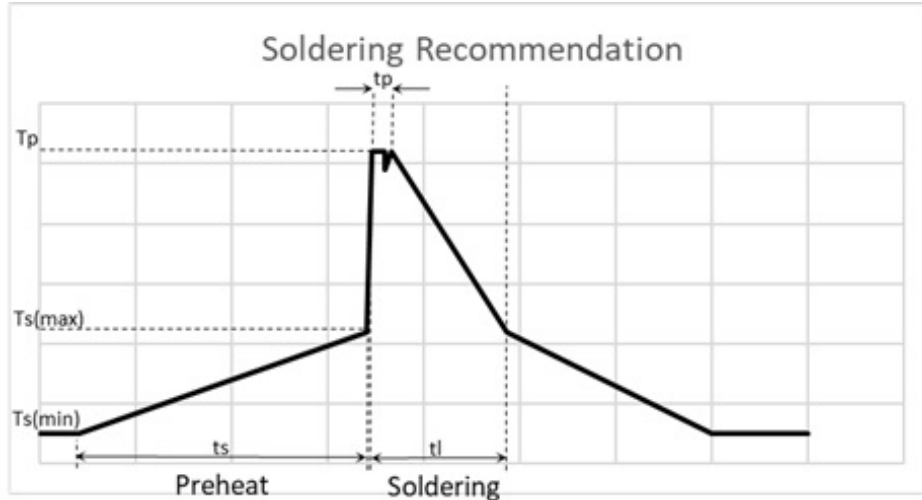

Profile feature

Preheat	• T_s maximum	110 °C
	• T_s minimum	NA
	• t_s	< 150 seconds
Preheat	• T_p	260 °C \pm 5 °C
	• t_p	< 10 seconds
	• t_l	\leq 60 seconds

Capacitor body maximum temperature at wave soldering \leq 120 °C

Manual solder

+400 °C, 3 seconds maximum by soldering iron, generally manual, hand soldering is not recommended

Life Support Policy: Eaton does not authorize the use of any of its products for use in life support devices or systems without the express written approval of an officer of the Company. Life support systems are devices which support or sustain life, and whose failure to perform, when properly used in accordance with instructions for use provided in the labeling, can be reasonably expected to result in significant injury to the user.

Eaton reserves the right, without notice, to change design or construction of any products and to discontinue or limit distribution of any products. Eaton also reserves the right to change or update, without notice, any technical information contained in this bulletin.

Eaton
Electronics Division
1000 Eaton Boulevard
Cleveland, OH 44122
United States
Eaton.com/electronics

© 2023 Eaton
All Rights Reserved
Printed in USA
Publication No. ELX1257 BU-ELX22121a
June 2023

Eaton is a registered trademark.
All other trademarks are property of their respective owners.

Follow us on social media to get the latest product and support information.

