

# E60213

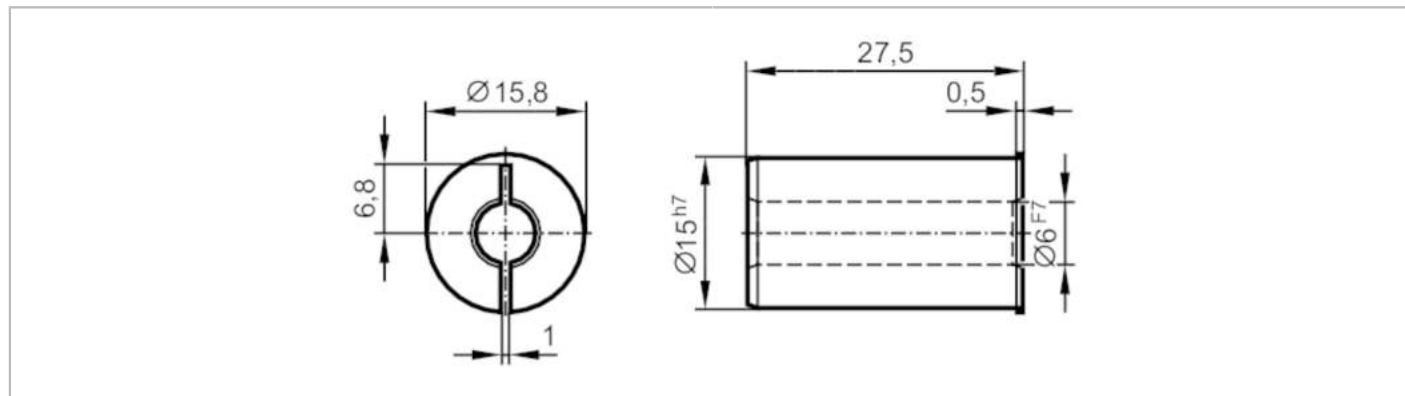

## Reducing bush

REDUCING SLEEVE FOR RO3 ROP15-6MM



Application	
Design	for hollow shaft encoders
Mechanical data	
Weight [g]	32.3
Inside diameter [mm]	6
External diameter [mm]	15
Materials	stainless steel (1.4305 / 303)
Length [mm]	27.5
Remarks	
Pack quantity	1 pcs.