

THREE PHASE (NO NEUTRAL) (208 / 240 VOLTS) (4-WIRE)

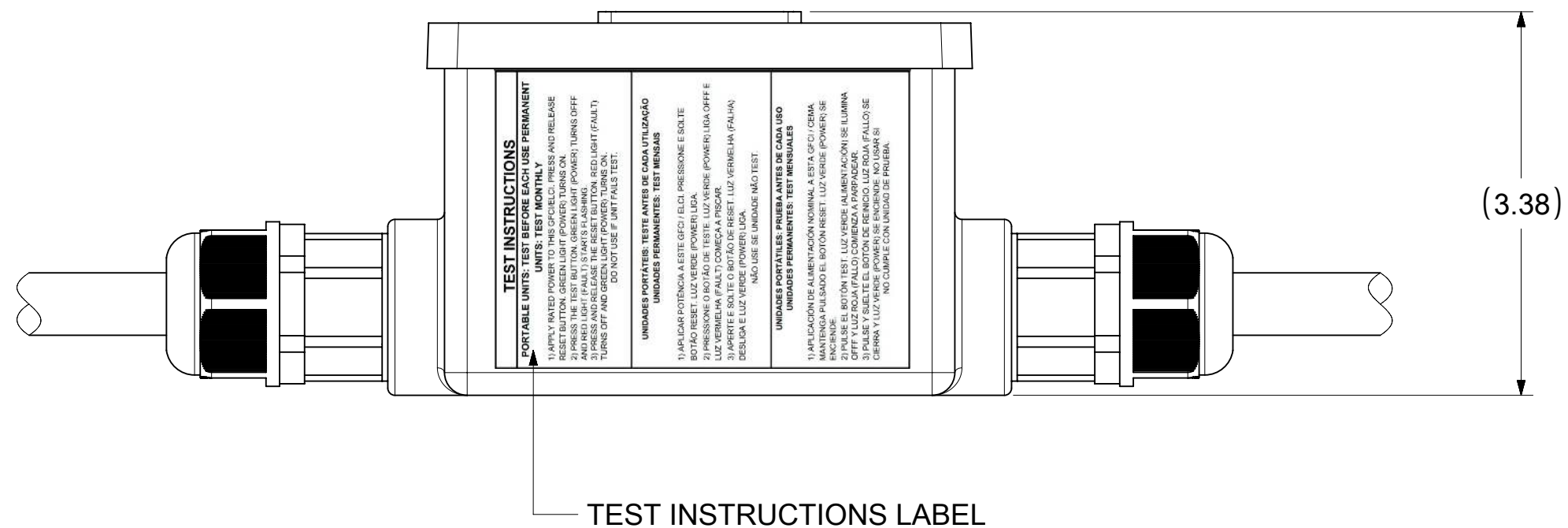
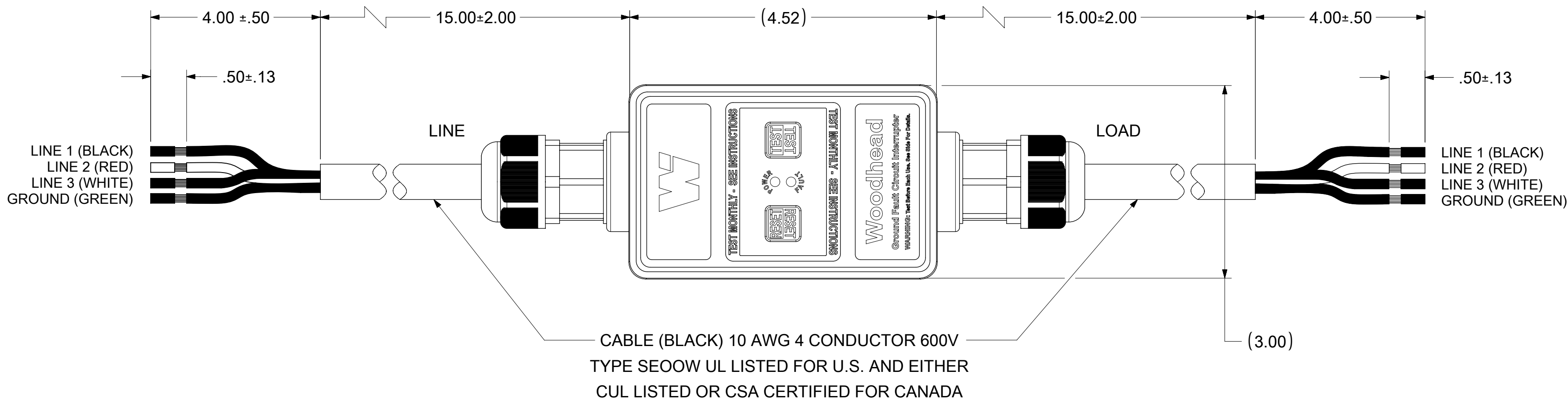

TECHNICAL

LISTED: UL & CSA
 RATED SUPPLY VOLTAGE: 208/204VAC
 RATED CURRENT: UP TO 30 AMPS
 RESET TYPE: AUTOMATIC OR MANUAL
 OPERATING FREQUENCY: 60 Hz
 TYPE: CLASS A
 GROUND TRIP CURRENT: 5mA +/- 1mA
 OVERLOAD CURRENT: 180 AMPS, 0.45PF
 INSULATION VOLTAGE: 1,500 VRMS - 1 MINUTE
 ENDURANCE OPERATIONS: 3000 OPERATIONS
 ENCLOSURE: NEMA 4X/6P

RESET TYPE	MATERIAL NO.	ENGINEERING NO.	NORTH SHORE SAFETY NO	PHASE	RATED VOLTAGE
MANUAL	1301530248	30053-0M3P	PGFI-730AN	THREE PHASE	240 VAC
	1301530249	30053-0M2P	PGFI-830AN	THREE PHASE	208 VAC
AUTOMATIC	1301530252	30053-0A3P	PGFI-731AN	THREE PHASE	240 VAC
	1301530253	30053-0A2P	PGFI-831AN	THREE PHASE	208 VAC

FUNCTIONAL SYMBOLS FA = 0 FC = 0 FP = 0	THIS DRAWING CONTAINS INFORMATION THAT IS PROPRIETARY TO MOLEX ELECTRONIC TECHNOLOGIES, LLC AND SHOULD NOT BE USED WITHOUT WRITTEN PERMISSION				
	DIMENSION UNITS INCH		SCALE NTS		CURRENT REV DESC: MIGRATION TO ECTR/NX
	GENERAL TOLERANCES (UNLESS SPECIFIED)				
	4 PLACES ±		3 PLACES ±		2 PLACES ±
DIVISIONAL SYMBOLS	1 PLACE ±		0 PLACES ±		ANGULAR TOL ± °
	DRAFT WHERE APPLICABLE MUST REMAIN WITHIN DIMENSIONS		THIRD ANGLE PROJECTION	DRAWING C-SIZE	SERIES 130153
	EC NO: 664991		DRWN: PPURSUTANDEL 2021/07/23		 30A, 240VAC 3PHASE, 2' 10/4 PRODUCT CUSTOMER DRAWING
	CHK'D: DNGUYEN62 2021/07/28		APPR: HKNEELAND 2021/07/29		
INITIAL REVISION: DRWN: PPURSUTANDEL 2021/07/23		APPR: HKNEELAND 2021/07/29		DOCUMENT NUMBER 1301530248	
MATERIAL NUMBER SEE TABLE		CUSTOMER GENERAL MARKET		DOC TYPE PSD	
SHEET NUMBER 1 OF 1		DOC PART 000		REVISION B2	

OLD DOCUMENT NO. SD-130153-040

TECHNICAL:
RATED VOLTAGE: 120VAC, 208VAC, 240VAC, 277VAC, 120/240VAC, 120/208VAC Dual Voltage, 120/208VAC 3Ø, 208VAC 3Ø, 240VAC 3Ø (277VAC non-U.L.)
OPERATING VOLTAGE RANGE: 85% TO 110% OF RATED
CURRENT: UP TO 30 AMPS OR WIRING DEVICE RATING
FREQUENCY: 60Hz, 50Hz (AVAILABLE non-UL)
TRIP LEVEL: 5 ± 1mA
PHASE: SINGLE, DUAL VOLTAGE, AND THREE-PHASE
RESPONSE TIME: 25 mS MAX. @500 OHM FAULT
DIELECTRIC WITHSTAND: 1500 VRMS ACROSS CONTACT
 4000 VRMS BETWEEN CONDUCTORS AND ENCLOSURE
SURGE WITHSTAND: 6000V IMPULSE, 0.5 MICROSECOND RISE TIME 100KHZ RINGING FREQUENCY WITH 40% DECAY PER CYCLE
OPERATING TEMPERATURE RANGE: -35°C TO +66°C (-31°F TO +151°F)
LEAKAGE CURRENT @ 93% HUMIDITY: ZERO
OVERLOAD CURRENT: 180 AMPS, 50% INDUCTIVE (25 CYCLES)
RF NOISE SUSCEPTIBILITY: NORMAL OPERATION WITH 0.5 VRMS INJECTED ON POWER LINE WITH FREQUENCIES UP TO 450 MHz
CURRENT FILTERS: SPECIFICALLY FILTERED TO MINIMIZE NUISANCE TRIPS IN WELDING, VARIABLE FREQUENCY DRIVE AND OTHER 'ELECTRICALLY NOISY' APPLICATIONS
LET GO LINE VOLTAGE: 60% OF RATED
GROUNDING DETECTION: 2 OHMS OR LESS (ON APPLICABLE MODELS ONLY)

GENERAL:
CONSTRUCTION: INDUSTRIAL GRADE DESIGN
TYPE: CLASS A
POWER-UP TYPE: AUTO OR MANUAL
ENDURANCE: 5000 OPERATIONS MINIMUM AT RATED LOAD
OPEN NEUTRAL PROTECTION: TRIPS UPON LOSS OF NEUTRAL (ON APPLICABLE MODELS ONLY)
GROUNDING NEUTRAL PROTECTION: TRIPS IF GROUND AND NEUTRAL TOUCH AT LOAD SIDE (ON APPLICABLE MODELS ONLY)
POWER ON INDICATION: LIGHTED GREEN LED
POWER OFF INDICATION: BLINKING RED LED, PLUS OPTIONAL ANNUNCIATOR OF AC/DC OUTPUTS (ON APPLICABLE MODELS ONLY)
ENCLOSURE: NEMA 4X/P6
MOUNTING TYPE: PANEL, SURFACE AND PORTABLE
WIRING APPLICATION: 3,4,5 WIRE SINGLE, SPLIT, AND 3-PHASE
WIRING CONNECTIONS: PORTABLE (IN-LINE) AND PERMANENT (FIXED MOUNT) (SEE WIRING INSTRUCTIONS)
SWITCH INTERFACE: DOUBLE INSULATED
LATCHING MECHANISM: ELECTROMAGNETIC
FALSE TRIP DUE TO IMPACT: NONE
AGENCY APPROVAL: cULus, CSA, CSAus and cCSAus (U.L.943 and CSA C22.2 No. 144) (277VAC non-U.L.)

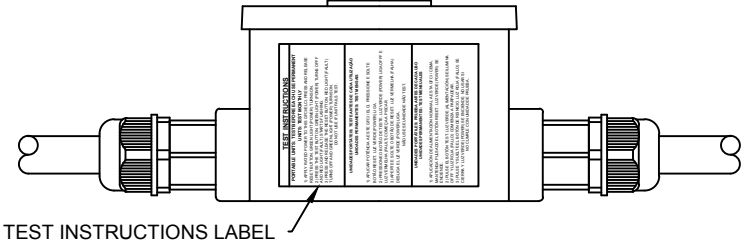
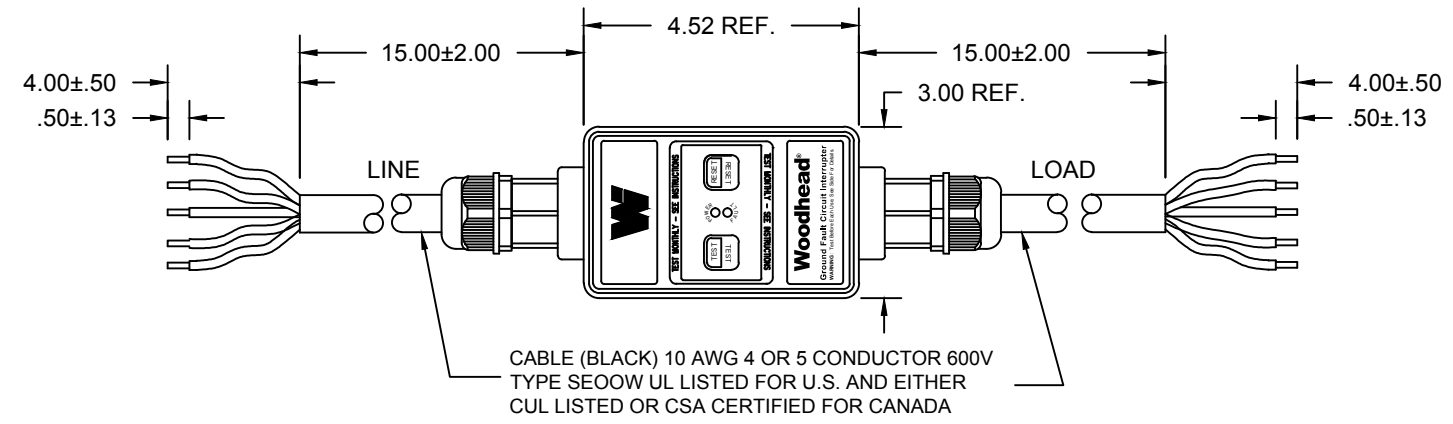
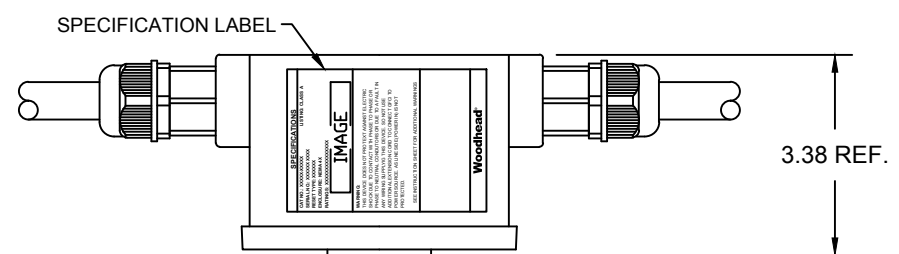

FIGURE 1
SPLIT PHASE (120 / 208 VOLTS, 120 / 240 VOLTS) (4-WIRE)

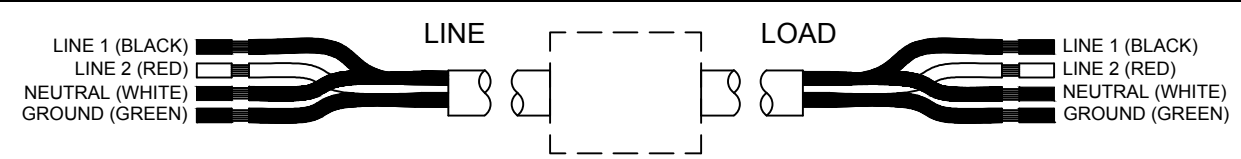

FIGURE 2
THREE PHASE (NO NEUTRAL) (208 / 240 VOLTS) (4-WIRE)

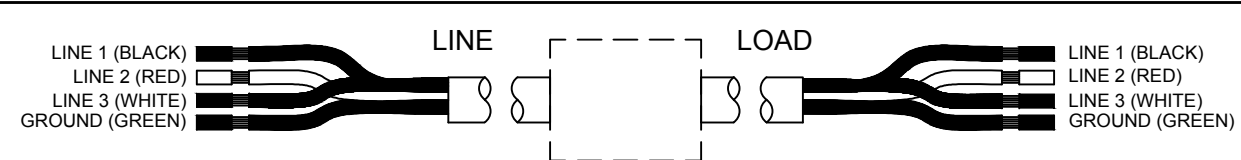
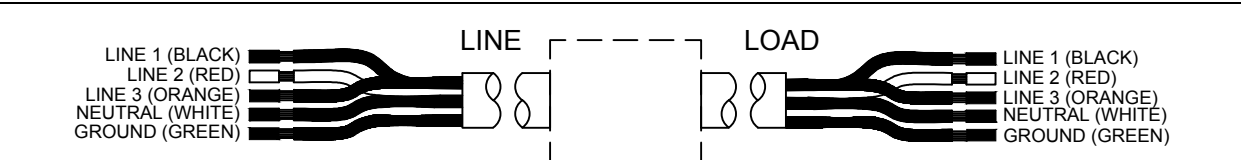

FIGURE 3
THREE PHASE (WITH NEUTRAL) (120 / 208 VOLTS) (5-WIRE)



RESET TYPE	MATERIAL NO.	ENGINEERING NO.	PHASE	FIGURE
MANUAL	1301530247	30053-0M6P	SPLIT PHASE	FIGURE 1
	1301530248	30053-0M3P	THREE PHASE	FIGURE 2
	1301530249	30053-0M2P	THREE PHASE	FIGURE 2
	1301530250	30053-0M5P	THREE PHASE W/ NEUTRAL	FIGURE 3
AUTOMATIC	1301530251	30053-0A6P	SPLIT PHASE	FIGURE 1
	1301530252	30053-0A3P	THREE PHASE	FIGURE 2
	1301530253	30053-0A2P	THREE PHASE	FIGURE 2
	1301530254	30053-0A5P	THREE PHASE W/ NEUTRAL	FIGURE 3

UPDATED SPECS
 EC NO: IPG2014-1788
 DRWN: BARDEN 2014/04/14
 CHKD: HKNEELAN 2014/04/30
 APPR: JFMURPHY 2014/03/27

QUALITY SYMBOLS 	GENERAL TOLERANCES (UNLESS SPECIFIED)		DIMENSION STYLE		SCALE	DESIGN UNITS	THIRD ANGLE PROJECTION
		mm	INCH	INCH		NTS	
	4 PLACES	±---	±---	DRAWN BY	DATE	TITLE	
	3 PLACES	±---	±.005	BARDEN	2014/01/07	PORTABLE GFCI WITH LEADS 30AMP SPLIT & 3 PHASE #10/4&5 CABLE	
	2 PLACES	±0.13	±.010	CHECKED BY	DATE	MOLEX INCORPORATED	
	1 PLACE	±0.25	±.020	APPROVED BY	DATE	SD-130153-040	
	ANGULAR ±.5°		MATERIAL NO.		DOCUMENT NO.		SHEET NO.
	DRAFT WHERE APPLICABLE MUST REMAIN WITHIN DIMENSIONS		SEE CHART		SD-130153-040		1 OF 1
	SIZE B	THIS DRAWING CONTAINS INFORMATION THAT IS PROPRIETARY TO MOLEX INCORPORATED AND SHOULD NOT BE USED WITHOUT WRITTEN PERMISSION					