

3500 series

High performance toggle switches •
environmentally sealed



DISTINCTIVE FEATURES

- Completely sealed switches withstanding 0.1 bar pressure
- Approved to European standards CECC 96000
- Three types of terminals
- Many lever styles available



ENVIRONMENTAL SPECIFICATIONS

- Front sealing to IP67 or IP69K by a silicone membrane (for sealed panel mounting, add washer U60).
- Rear sealing to IP64 provided by moulded-in terminal inserts
- Operating temperature : -40 °C to + 85°C (-40 °F to +185 °F)
- Moisture resistance : 56 days



ELECTRICAL SPECIFICATIONS

- Max. current/voltage rating with resistive load and electrical life at full load: see table below
- Initial contact resistance : 10 mΩ max. at 1 A 2 VDC
- Insulation resistance : 1,000 MΩ
- Dielectric strength : 2,500 Vrms 50 Hz min. between terminals
3,000 Vrms 50 Hz min. between terminals and frame

FUNCTIONS	GENERAL PERFORMANCES
ON-OFF and ON-ON	10,000 cycles, T20 °C 15 A 28 VDC resistive 15 A 28 VDC inductive 5 A 28 VDC lamp
ON OFF ON	10,000 cycles, T20 °C 15 A 28 VDC resistive 15 A 28 VDC inductive 5 A 28 VDC lamp
OTHER FUNCTIONS	10,000 cycles, T20 °C 15 A 28 VDC resistive 10 A 28 VDC inductive 3 A 28 VDC lamp

The company reserves the right to change specifications without notice.



3500 series

High performance toggle switches • environmentally sealed



GENERAL SPECIFICATIONS

- Mechanical life : 40,000 cycles
- Torque : 2 Nm (1.47 Ft.lb) max. applied to nut
- Panel thickness :
For NON-SEALED mounting (panel cut-out fig. 1, 2 or 3) : 5 mm (.196) max.
For SEALED mounting (panel cut-out fig. 2) : 4 mm (.157) max.



MATERIALS

- Case : mineral filled polyester UL94-V0
- Bushing and cover : zamac
- Actuator : brass, nickel or chrome plated, or anodized aluminum
- Contacts : silver alloy

AGENCY APPROVAL



CECC 96201-004

Availability : consult factory for details of approved models.

Marking : to order switches marked CECC, complete appropriate box of ordering format.



TERMINALS

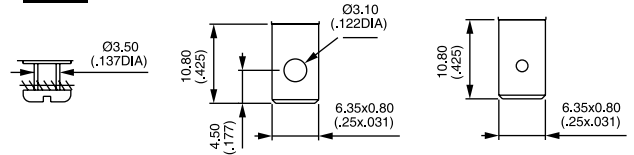

ELECTRICAL FUNCTIONS

→ KEYWAY

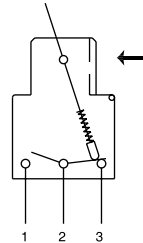

PANEL CUT-OUT

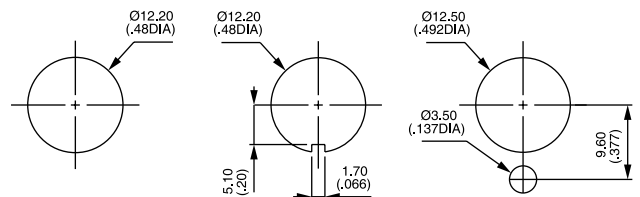

Figure 1

Figure 2

Figure 3

3500 series

High performance toggle switches • environmentally sealed



BUILD YOUR PART NUMBER

BASIC PART NUMBER

SERIES	NUMBER OF POLES	ELECTRICAL FUNCTIONS	TERMINALS
35			
3	Single pole	1-0 ON - OFF	0 Screw
4	Double pole	2-0 ON - m.OFF	2 Solder lug/quick-connect
		3-0 OFF - MOM	3 Normalized quick-connect
		4-1 ON ³ ON ⁴ ON ▲	4 Screw + clamp
		4-2 ON ³ ON ⁴ MOM ▲	
		4-3 MOM ³ ON ⁴ MOM ▲	
		4-4 ON ¹ ON ⁶ ON ▲	
		4-5 ON ¹ ON ⁶ MOM ▲	
		4-6 MOM ¹ ON ⁶ MOM ▲	
		5-0 ON - MOM	
		6-0 ON - ON	
		7-0 MOM OFF MOM	
		8-0 ON OFF MOM	
		9-0 ON OFF ON	

▲ Function 4 : double pole only

OPTIONS

LEVER FINISH	AGENCY APPROVAL	LOCKING LEVER SPECIAL FINISH
N Bright nickel	0 None	(blank) None
B Satin chrome	1 CECC	P5 Painted yellow
G* Black		A6 Anodized red
F* Black with fluorescent tip (lever type 1 only)		Order with lever finish type C. Other colors : on request.
C Painted or anodized		

*Black finish on bushing too.

LEVER STYLES	LEVER LOCKING STYLES	ACCESSORIES
1 Standard, length 17.5 mm (.688) or locking, length 20 mm (.787)	0 No locking	0 2 hex nuts, 1 locking ring and 1 lockwasher (non-sealed mounting)
2 Length 30 mm (1.181)	A Locked in 3 positions	2 2 hex nuts and 1 sealing washer (sealed mounting)
3 Flatted, length 24 mm (.944)	D Locked out of center position	
4 Length 40 mm (1.574)	G Locked in keyway side	
5 Length 50 mm (1.968)		
6 Locking, length 25.4 mm (1.000)	See drawings on the following pages.	



ABOUT THIS SERIES

On the following pages, you will find successively basic part numbers of switches and options in the same order as in above chart.

- ⚠ **Notice** : please note that not all combinations of above numbers are available. Refer to the following pages for further information.
- 🛡 **Switch guards** are available to prevent inadvertent lever operation. See "Switch Guards" section of website.
- 🔧 **Mounting accessories** : see above and on the following pages.

3500 series

High performance toggle switches • environmentally sealed

SCREW TERMINALS SINGLE POLE



	Angle of throw (A)	III A2-A3	II	I
3531-00	22°	ON	-	OFF
3532-00	22°	ON	-	m.OFF
3533-00	22°	OFF	-	MOM
3535-00	22°	ON	-	MOM
3536-00	22°	ON	-	ON
3537-00	22°	MOM	OFF	MOM
3538-00	30°	ON	OFF	MOM
3539-00	30°	ON	OFF	ON

SCREW TERMINALS DOUBLE POLE



	Angle of throw (A)	III A2-A3 B5-B6	II *A3-B5 **A1-B5	I A1-A2 B5-B4
3541-00	22°	ON	-	OFF
3544-10	22°	ON	ON*	ON
3544-20	22°	ON	ON*	MOM
3544-30	22°	MOM	ON*	MOM
3545-00	22°	ON	-	MOM
3546-00	22°	ON	-	ON
3547-00	22°	MOM	OFF	MOM
3548-00	30°	ON	OFF	MOM
3549-00	30°	ON	OFF	ON

SOLDER LUG/QUICK-CONNECT TERMINALS SINGLE POLE



	Angle of throw (A)	III A2-A3	II	I
3531-02	22°	ON	-	OFF
3532-02	22°	ON	-	m.OFF
3533-02	22°	OFF	-	MOM
3535-02	22°	ON	-	MOM
3536-02	22°	ON	-	ON
3537-02	22°	MOM	OFF	MOM
3538-02	30°	ON	OFF	MOM
3539-02	30°	ON	OFF	ON

SOLDER LUG/QUICK-CONNECT TERMINALS DOUBLE POLE



	Angle of throw (A)	III A2-A3 B5-B6	II *A3-B5 **A1-B5	I A1-A2 B5-B4
3541-02	22°	ON	-	OFF
3544-12	22°	ON	ON*	ON
3544-22	22°	ON	ON*	MOM
3544-32	22°	MOM	ON*	MOM
3545-02	22°	ON	-	MOM
3546-02	22°	ON	-	ON
3547-02	22°	MOM	OFF	MOM
3548-02	30°	ON	OFF	MOM
3549-02	30°	ON	OFF	ON

→ KEYWAY

Shown with standard lever

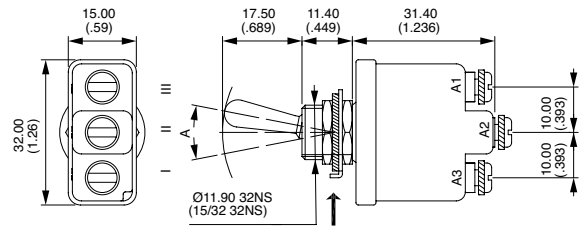

→ KEYWAY

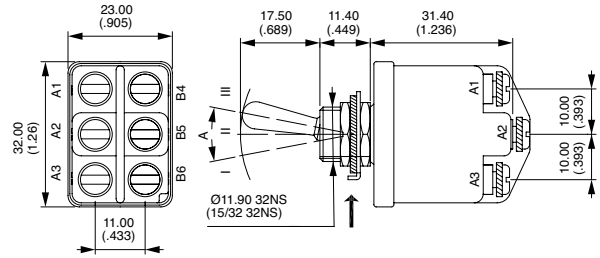

Also available in functions ON-m.OFF and OFF-MOM.

→ KEYWAY

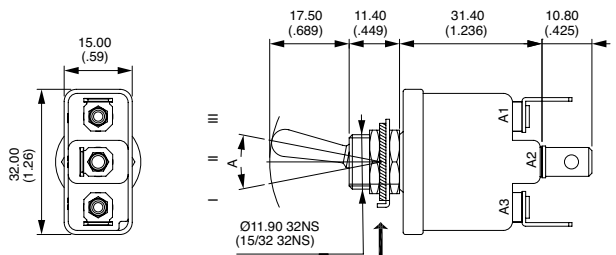

→ KEYWAY

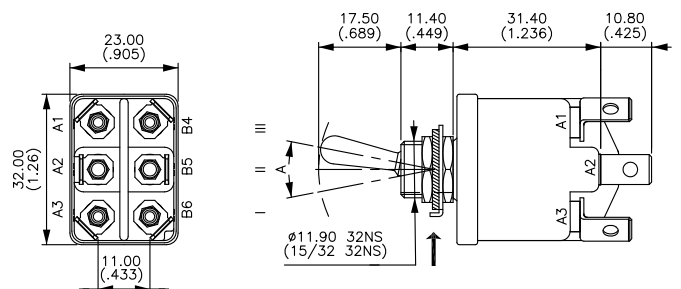

Also available in functions ON-m.OFF and OFF-MOM.

*and** : A2-B4 and A2-B6 = jumper to be wired by the user.

3500 series

High performance toggle switches • environmentally sealed

NORMALIZED QUICK-CONNECT TERMINALS SINGLE POLE



	Angle of throw (A)	III A2-A3	II	I A1-A2
3531-03	22°	ON	-	OFF
3532-03	22°	ON	-	m.OFF
3533-03	22°	OFF	-	MOM
3535-03	22°	ON	-	MOM
3536-03	22°	ON	-	ON
3537-03	22°	MOM	OFF	MOM
3538-03	30°	ON	OFF	MOM
3539-03	30°	ON	OFF	ON

→ KEYWAY

Shown with standard lever

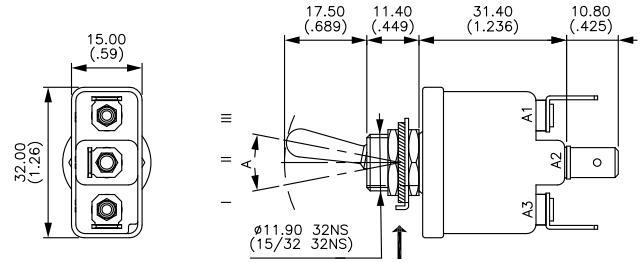

NORMALIZED QUICK-CONNECT TERMINALS DOUBLE POLE



	Angle of throw (A)	III A2-A3 B5-B6	II *A3-B5 **A1-B5	I A1-A2 B5-B4
3541-03	22°	ON	-	OFF
3544-13	22°	ON	ON*	ON
3544-23	22°	ON	ON*	MOM
3544-33	22°	MOM	ON*	MOM
3545-03	22°	ON	-	MOM
3546-03	22°	ON	-	ON
3547-03	22°	MOM	OFF	MOM
3548-03	30°	ON	OFF	MOM
3549-03	30°	ON	OFF	ON

→ KEYWAY

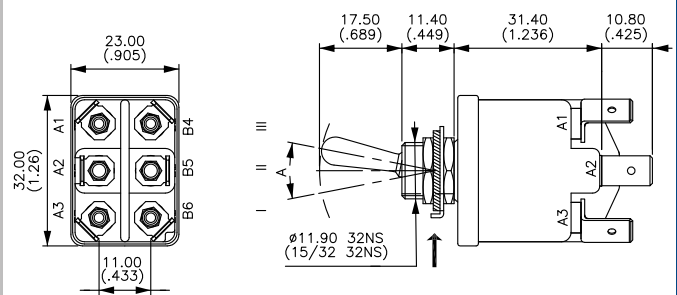

Also available in functions ON-m.OFF and OFF-MOM.

*and**: A2-B4 and A2-B6 = jumper to be wired by the user.

LEVER STYLES

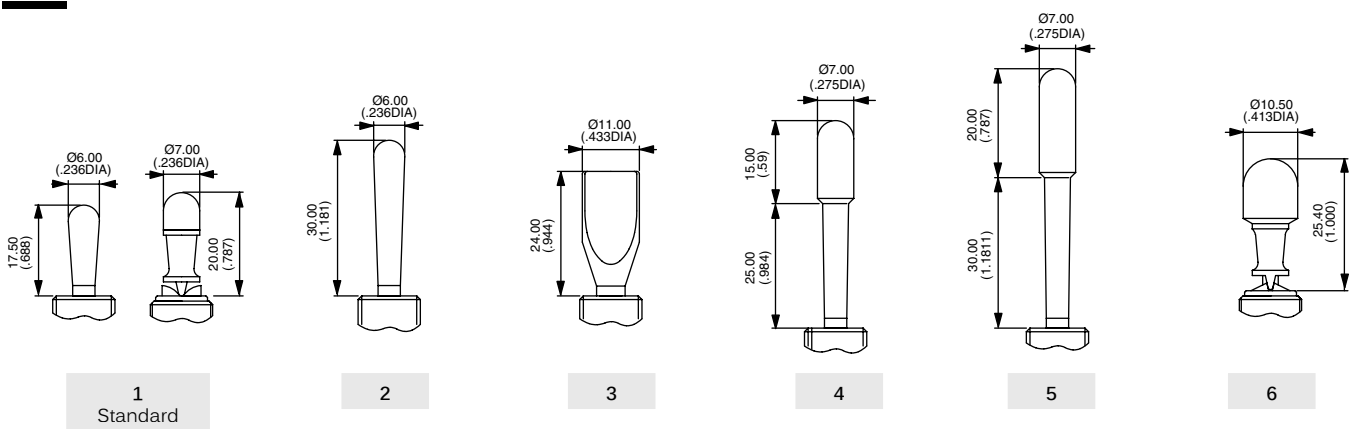

3500 series

High performance toggle switches • environmentally sealed

LEVER FINISH



- N Bright nickel
- B Satin chrome
- G* Black
- F* Black with fluorescent tip (available with lever type 1 only)
- C Painted or anodized (for locking lever only)

* Black finish on bushing too.

LOCKING LEVER STYLES



- 0 No locking
- A Locked in 3 positions. For functions 4-1, 4-4 and 9-0.
- D Locked out of center position. For functions 1-0 and 6-0.
- G Locked in keyway. For functions 1-0 and 6-0.

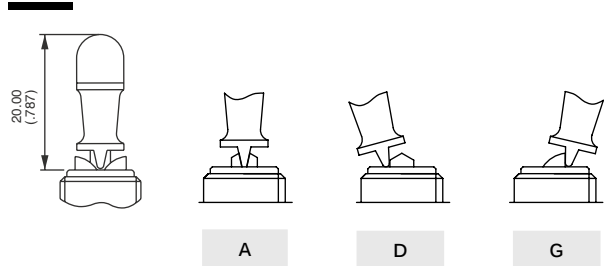

AGENCY APPROVAL



- 0 None
- 1 CECC

MOUNTING ACCESSORIES



- 0 For NON-SEALED mounting (panel cut-out fig. 1, 2 or 3)
2 hex nuts 14 mm (.551) across flats, 1 locking ring U121 or U12, 1 lockwasher U13
Panel thickness : 5 mm (.196) max.
- 2 For SEALED mounting (panel cut-out fig. 2)
2 hex nuts 14 mm (.551) across flats and 1 sealing washer U60
Panel thickness : 4 mm (.157) max.

Special hardware : black cap nut U129. Order separately. See "Hardware" section of website.

LOCKING LEVER SPECIAL FINISH



- (blank) None
 - P5 Painted yellow
 - A6 Anodized red
- Order with lever finish type C.
Other colors on request.