

## 2A, 20V - 150V Schottky Barrier Surface Mount Rectifier

### FEATURES

- Low power loss, high efficiency
- Ideal for automated placement
- Guard ring for over-voltage protection
- High surge current capability
- Moisture sensitivity level: level 1, per J-STD-020
- RoHS Compliant
- Halogen-free according to IEC 61249-2-21

### APPLICATIONS

- Switching mode power supply (SMPS)
- Adapters
- Lighting application
- Converter

### MECHANICAL DATA

- Case: DO-214AC (SMA)
- Molding compound meets UL 94V-0 flammability rating
- Terminal: Matte tin plated leads, solderable per J-STD-002
- Meet JESD 201 class 2 whisker test
- Polarity: Indicated by cathode band
- Weight: 0.070g (approximately)

KEY PARAMETERS		
PARAMETER	VALUE	UNIT
$I_F$	2	A
$V_{RRM}$	20 - 150	V
$I_{FSM}$	50	A
$T_{JMAX}$	125, 150	°C
Package	DO-214AC (SMA)	
Configuration	Single die	



DO-214AC (SMA)



ABSOLUTE MAXIMUM RATINGS ( $T_A = 25^\circ\text{C}$ unless otherwise noted)										
PARAMETER	SYMBOL	SK 22A	SK 23A	SK 24A	SK 25A	SK 26A	SK 29A	SK 210A	SK 215A	UNIT
Marking code on the device		SK 22A	SK 23A	SK 24A	SK 25A	SK 26A	SK 29A	SK 210A	SK 215A	
Repetitive peak reverse voltage	$V_{RRM}$	20	30	40	50	60	90	100	150	V
Reverse voltage, total rms value	$V_{R(RMS)}$	14	21	28	35	42	63	70	105	V
Forward current	$I_F$	2								A
Surge peak forward current, 8.3ms single half sine-wave superimposed on rated load	$I_{FSM}$	50								A
Non-repetitive peak reverse avalanche energy, $L = 40\text{mH}$	$E_{RSM}$	20								mJ
Critical rate of rise of off-state voltage	$dV/dt$	10,000								V/ $\mu\text{s}$
Junction temperature	$T_J$	-55 to +125				-55 to +150				°C
Storage temperature	$T_{STG}$	-55 to +150								°C

<b>THERMAL PERFORMANCE</b>			
PARAMETER	SYMBOL	TYP	UNIT
Junction-to-ambient thermal resistance	$R_{\theta JA}$	88	°C/W

<b>ELECTRICAL SPECIFICATIONS</b> ( $T_A = 25^\circ\text{C}$ unless otherwise noted)						
PARAMETER		CONDITIONS	SYMBOL	TYP	MAX	UNIT
Forward voltage <sup>(1)</sup>	SK22A SK23A SK24A	$I_F = 2\text{A}, T_J = 25^\circ\text{C}$	$V_F$	-	0.50	V
	SK25A SK26A			-	0.70	V
	SK29A SK210A			-	0.85	V
	SK215A			-	0.95	V
Reverse current @ rated $V_R$ <sup>(2)</sup>	SK22A SK23A SK24A SK25A SK26A	$T_J = 25^\circ\text{C}$	$I_R$	-	0.5	mA
	SK29A SK210A SK215A			-	0.1	mA
	SK22A SK23A SK24A	$T_J = 100^\circ\text{C}$	$I_R$	-	10	mA
	SK25A SK26A			-	5	mA
	SK29A SK210A SK215A			-	-	mA
	SK22A SK23A SK24A SK25A SK26A	$T_J = 125^\circ\text{C}$	$I_R$	-	-	mA
	SK29A SK210A SK215A			-	2	mA

**Notes:**

1. Pulse test with PW = 0.3ms
2. Pulse test with PW = 30ms

<b>ORDERING INFORMATION</b>		
ORDERING CODE <sup>(1)</sup>	PACKAGE	PACKING
SK2xA	DO-214AC (SMA)	7,500 / Tape & Reel

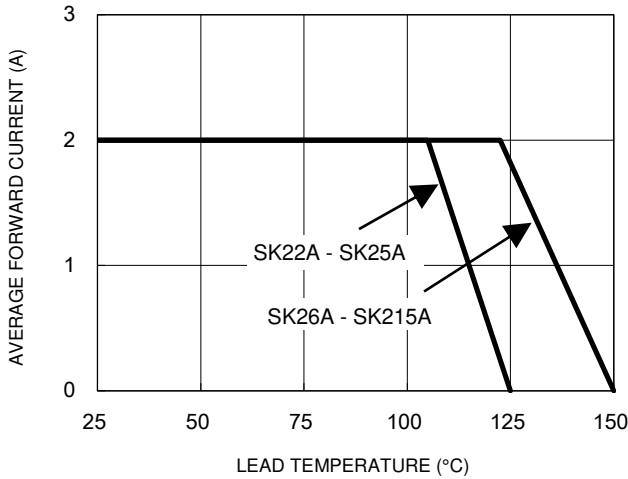
**Notes:**

1. "x" defines voltage from 20V(SK22A) to 150V(SK215A)

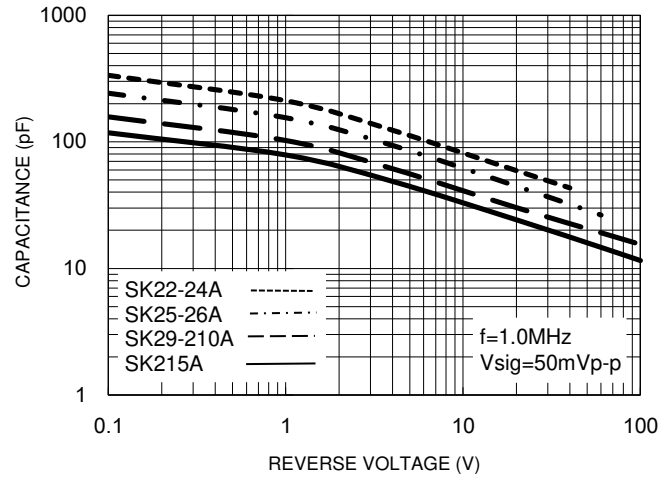
**CHARACTERISTICS CURVES**

( $T_A = 25^\circ\text{C}$  unless otherwise noted)

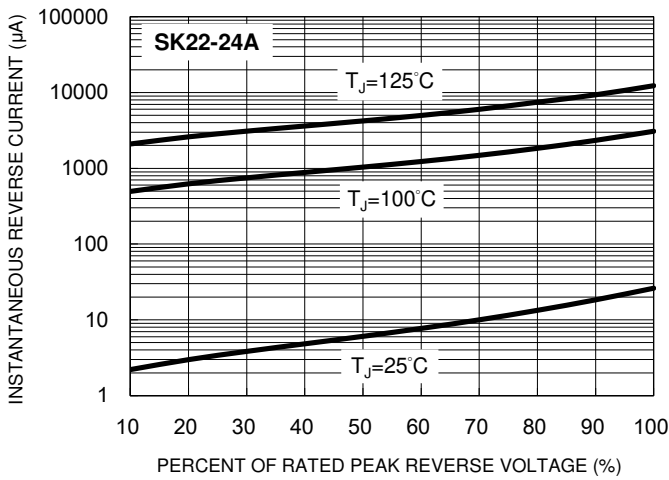
**Fig.1 Forward Current Derating Curve**



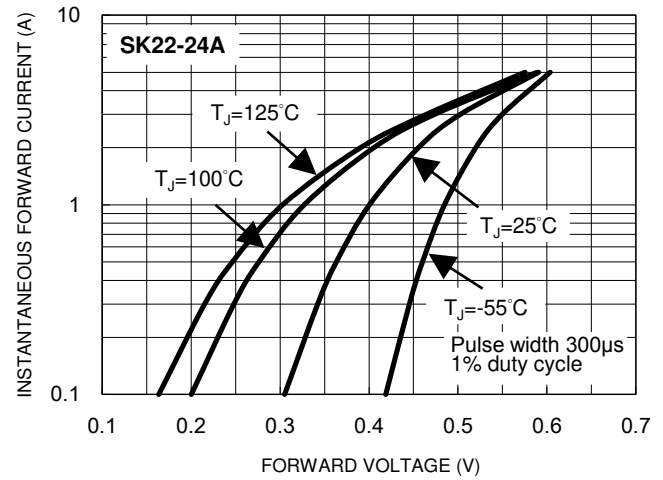
**Fig.2 Typical Junction Capacitance**



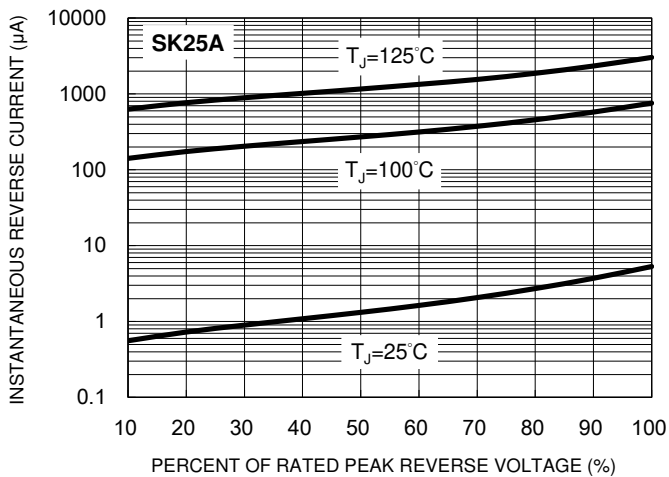
**Fig.3 Typical Reverse Characteristics**



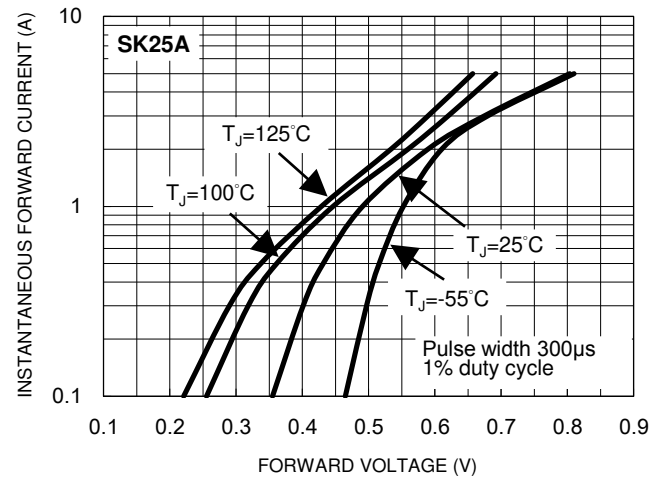
**Fig.4 Typical Forward Characteristics**



**Fig.5 Typical Reverse Characteristics**



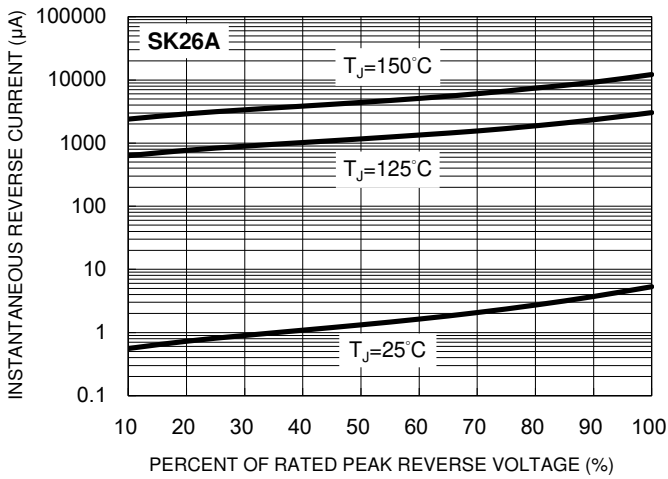
**Fig.6 Typical Forward Characteristics**



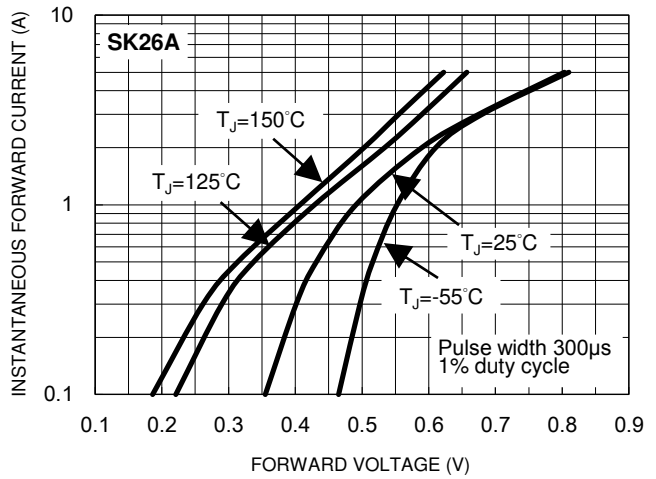
**CHARACTERISTICS CURVES**

( $T_A = 25^\circ\text{C}$  unless otherwise noted)

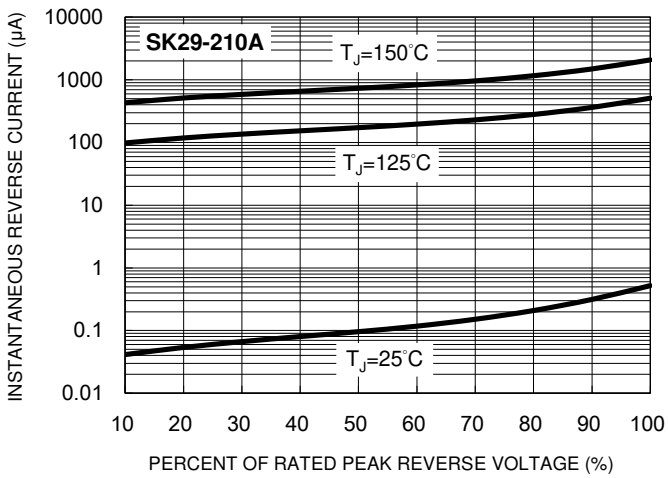
**Fig.7 Typical Reverse Characteristics**



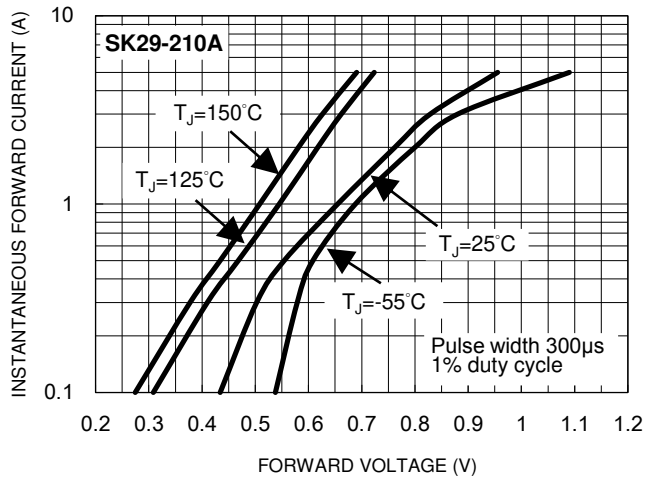
**Fig.8 Typical Forward Characteristics**



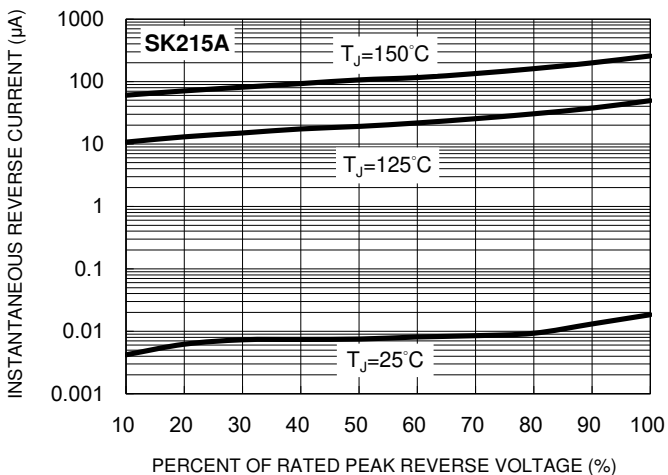
**Fig.9 Typical Reverse Characteristics**



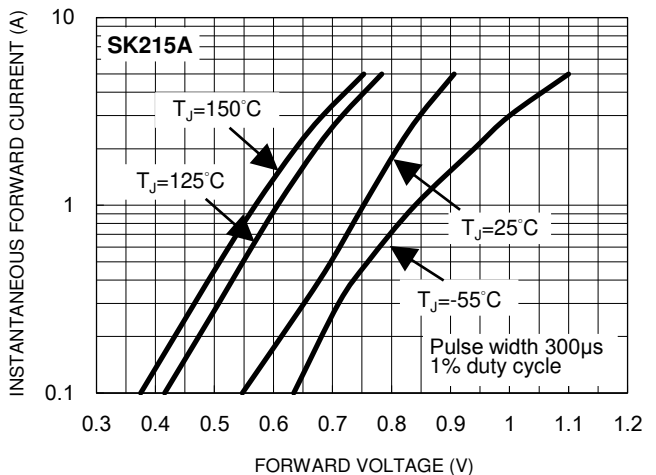
**Fig.10 Typical Forward Characteristics**



**Fig.11 Typical Reverse Characteristics**



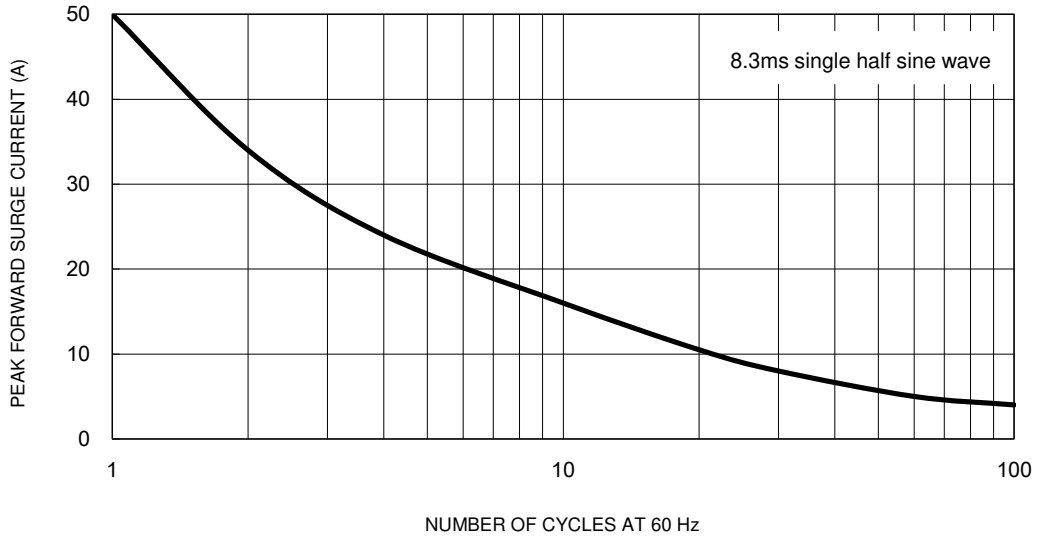
**Fig.12 Typical Forward Characteristics**



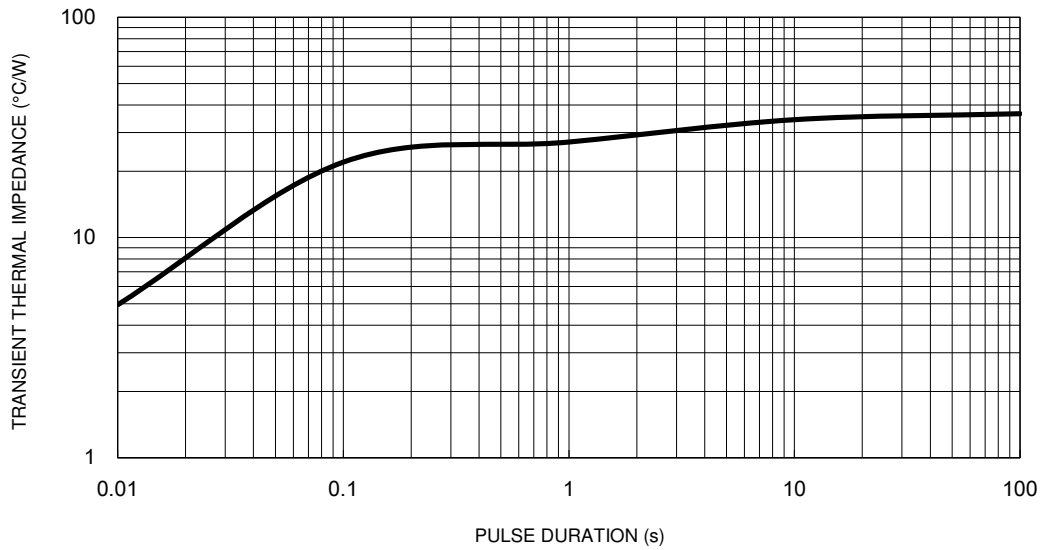
**CHARACTERISTICS CURVES**

( $T_A = 25^\circ\text{C}$  unless otherwise noted)

**Fig.13 Maximum Non-Repetitive Forward Surge Current**

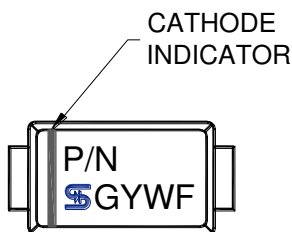
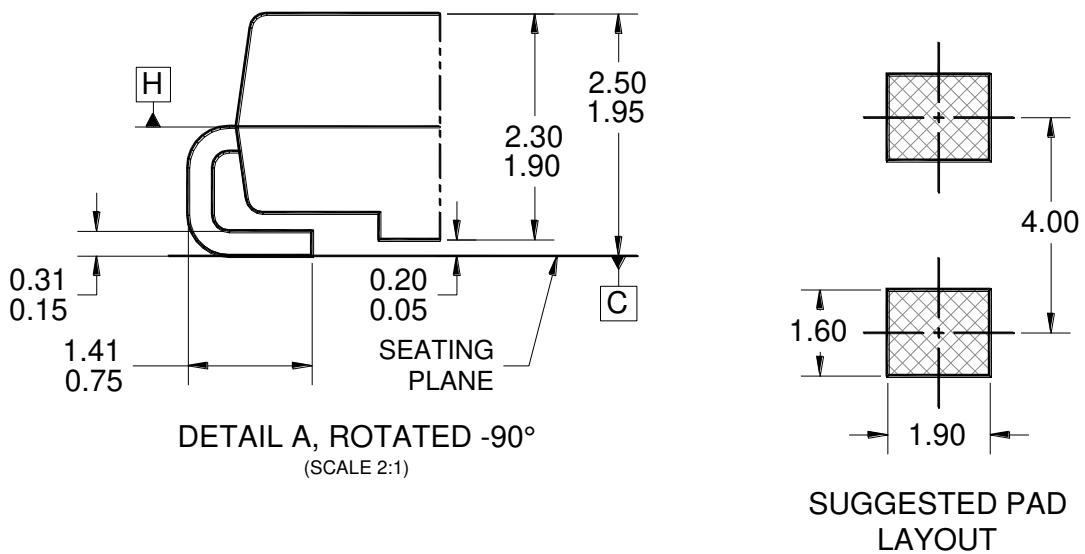
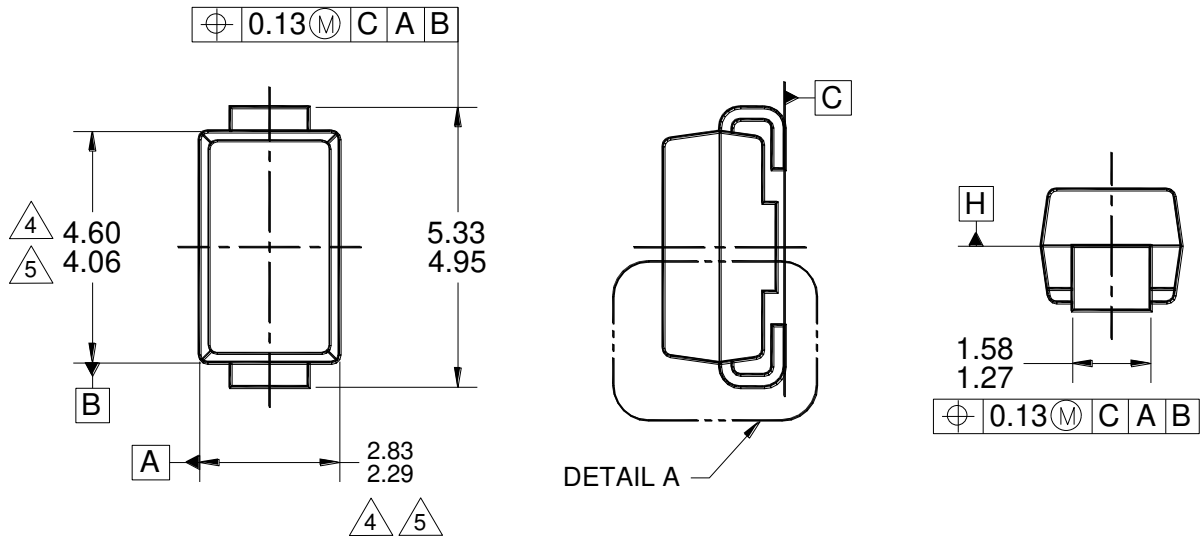


**Fig.14 Typical Transient Thermal Characteristics**



**PACKAGE OUTLINE DIMENSIONS**

**DO-214AC (SMA)**



**MARKING DIAGRAM**

P/N = MARKING CODE  
G = GREEN COMPOUND  
YW = DATE CODE  
F = FACTORY CODE

**NOTES: UNLESS OTHERWISE SPECIFIED**

1. ALL DIMENSIONS ARE IN MILLIMETERS.
2. DIMENSIONING AND TOLERANCING PER ASME Y14.5M-1994.
3. PACKAGE OUTLINE REFERENCE: JEDEC DO-214, VARIATION AC, ISSUE D.
4. MOLDED PLASTIC BODY DIMENSIONS DO NOT INCLUDE MOLD FLASH.
5. MOLDED PLASTIC BODY LATERAL DIMENSIONS TO BE DETERMINED AT DATUM PLANE H.
6. DWG NO. REF: HQ2SD07-DO214SMC-034 REV A.

## **Notice**

Specifications of the products displayed herein are subject to change without notice. TSC or anyone on its behalf assumes no responsibility or liability for any errors or inaccuracies.

Purchasers are solely responsible for the choice, selection, and use of TSC products and TSC assumes no liability for application assistance or the design of Purchasers' products.

Information contained herein is intended to provide a product description only. No license, express or implied, to any intellectual property rights is granted by this document. Except as provided in TSC's terms and conditions of sale for such products, TSC assumes no liability whatsoever, and disclaims any express or implied warranty, relating to sale and/or use of TSC products including liability or warranties relating to fitness for a particular purpose, merchantability, or infringement of any patent, copyright, or other intellectual property right.

The products shown herein are not designed for use in medical, life-saving, or life-sustaining applications. Customers using or selling these products for use in such applications do so at their own risk and agree to fully indemnify TSC for any damages resulting from such improper use or sale.