

SERIES: 18 W MULTI-BLADE

DESCRIPTION: SWITCHING POWER SUPPLY

FEATURES

- universal AC input
- regulated output voltage
- interchangeable input blade
- short circuit, over load protection
- meets EISA / efficiency level IV regulations
- custom designs available



MODEL	output voltage		output current		output wattage	ripple*	efficiency level	cord length (mm)
	nominal (V dc)		min (A)	max (A)	max (W)	max. (mVp-p)		
EMS050320	5		0	3.2	16	150	IV	1000 +150/-0
EMS060300	6		0	3	18	150	IV	1000 ±100
EMS070257	7		0	2.57	19.25	150	IV	1830 +150/-0
EMS090200	9		0	2	18	150	IV	1830 +150/-0
EMS120150	12		0	1.5	18	150	IV	1830 +150/-0
EMS150120	15		0	1.2	18	150	V	1830 +150/-0
EMS180100	18		0	1	18	150	V	1830 +150/-0
EMS200090	20		0	0.9	18	150	IV	1830 +150/-0
EMS240075	24		0	0.75	18	240	V	1830 +150/-0

*at full load, 100 ~ 240 V ac input, measured at 20MHz bandwidth with a 10 uF electrolytic cap and a 0.1 uF ceramic cap on the output

PART NUMBER KEY

EMS050320 - XX - SZ - CXX

Base Number
example of 5 V dc, 3.2 A

DC Plug type:
see output plug options
on page 5

Factory
Designation

Reserved for custom
configurations



SERIES: 18 W MULTI-BLADE

DESCRIPTION: SWITCHING POWER SUPPLY

INPUT

parameter	conditions/description	min	nom	max	units
rated input voltage		100		240	V ac
input voltage range		90		264	V ac
rated frequency		50		60	Hz
frequency range		47		63	Hz
rated input current				0.6	A
inrush current	115 V ac, full load, cold start, 25°C 230 V ac, full load, cold start, 25°C			30 60	A A
no load power consumption	100 ~ 240 V ac input			0.3	W

OUTPUT

parameter	conditions/description	min	nom	max	units
line regulation			±1		%
load regulation			±6		%
over voltage protection	output shut down	110%		140%	V dc
short circuit protection	output shut down and auto-restart				

SAFETY & EMI

parameter	conditions/description	min	nom	max	units
HI-POT	input to output at 10 mA for 1 minute			3000 4242	V ac V dc
insulation resistance	input to output at 500 V dc	100			MΩ
safety approvals	UL/cUL, CB (IEC60950-1), CE (GS/TUV EN60950-1)				
EMI standard	FCC part 15 class B, CE (EN55022, EN55024)				
leakage current				0.25	mA
RoHS compliant	yes				
LPS power supply	yes				

ENVIRONMENTAL

parameter	conditions/description	min	nom	max	units
operating temperature		0		40	°C
operating humidity		20		80	%
storage temperature		-10		70	°C
storage humidity		10		90	%



SERIES: 18 W MULTI-BLADE

DESCRIPTION: SWITCHING POWER SUPPLY

MECHANICAL DRAWING

input plug	interchangeable input blade (UL, UK, VDE, SAA)
case size	74 L x 43.5 W x 34 H mm tolerance: ± 1 mm

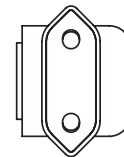
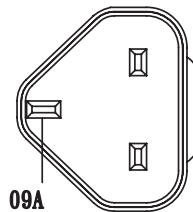
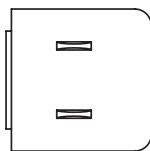
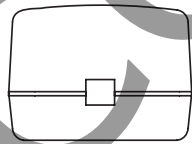
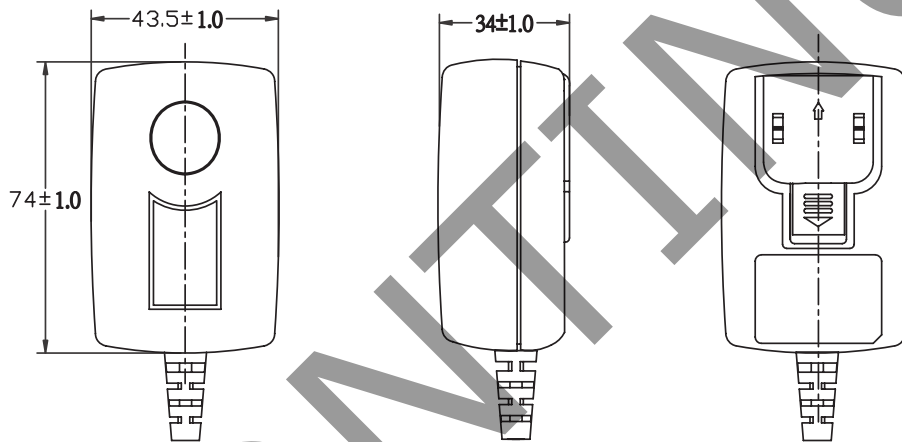



SERIES: 18 W MULTI-BLADE

DESCRIPTION: SWITCHING POWER SUPPLY

DC CORD

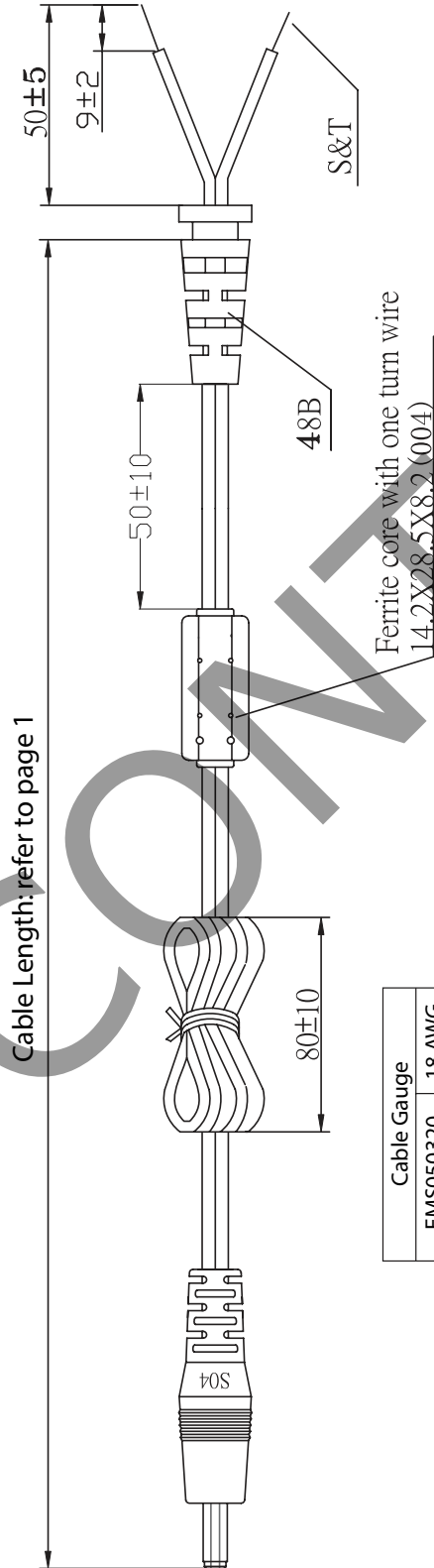

Cable Gauge	
EMS050320	18 AWG
EMS060300	18 AWG
EMS070257	18 AWG
EMS090200	18 AWG
EMS120150	20 AWG
EMS150120	20 AWG
EMS180100	20 AWG
EMS200090	20 AWG
EMS240075	20 AWG

SERIES: 18 W MULTI-BLADE

DESCRIPTION: SWITCHING POWER SUPPLY

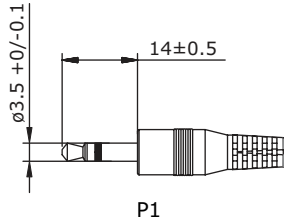
OUTPUT PLUG OPTIONS
3.5 mm Phono Plug

P1

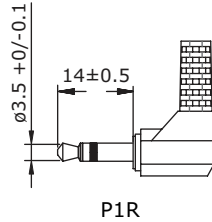

P1R

*Tip positive

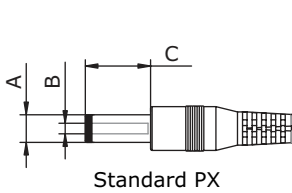
Standard DC Plug

Standard PX

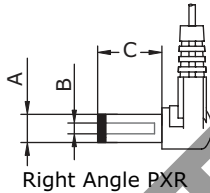

Right Angle PXR

	A	B	C	Unit
P5/P5R	5.5	2.1	9.5	mm
P6/P6R	5.5	2.5	9.5	mm
P7/P7R	3.5	1.35	9.5	mm
P8/P8R	3.8	1.35	9.5	mm
P9/P9R	3.8	1.05	9.5	mm

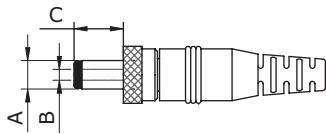
Locking DC Plug

 P10
P11

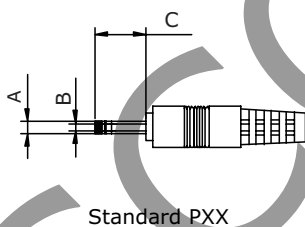
	A	B	C	Unit
P10	5.5	2.1	9.5	mm
P11	5.5	2.5	9.5	mm

EIAJ Plugs

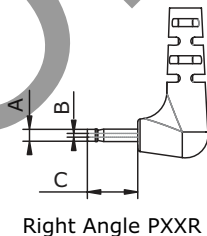
Standard PXX



Right Angle PXXR

	EIAJ	A	B	C	D	Unit
P12/P12R	EIAJ-1	2.35	0.7	9.5	NA	mm
P13/P13R	EIAJ-2	4.0	1.7	9.5	5.0	mm
P14/P14R	EIAJ-3	4.75	1.7	9.5	5.0	mm

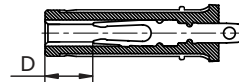
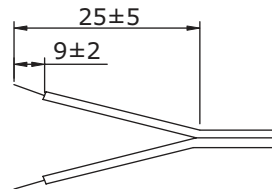
Stripped and Tinned

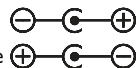
DC PLUG TYPE
ST
 Stripped and Tinned

PXXXX
 Plug Type Plug Angle:
 "Blank" = Standard
 R = Right Angle Plug Polarity:
 "Blank" = N/A
 P = Center Positive 
 N = Center Negative

 *Contact CUI for additional output plug options.
 *Contact CUI for additional output plug options.



SERIES: 18 W MULTI-BLADE

DESCRIPTION: SWITCHING POWER SUPPLY

INDIVIDUAL PACKAGING

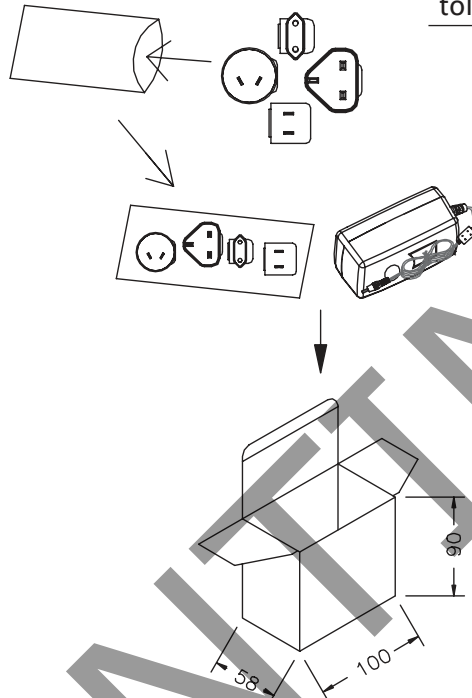

tolerance ± 1 mm

PACKAGING

tolerance $+7 / -0$ mm

CARTON SIZE: 485X428X210mm
Q'TY: 60pcs(20x3x1)

