

REVISIONS				
P	LTR	DESCRIPTION	DATE	APVD
B	I	REVISED PER ECR-10-019377	30SEP2010	HMR T.M
C		REVISED PER ECR-14-000206	26DEC2013	DR RB

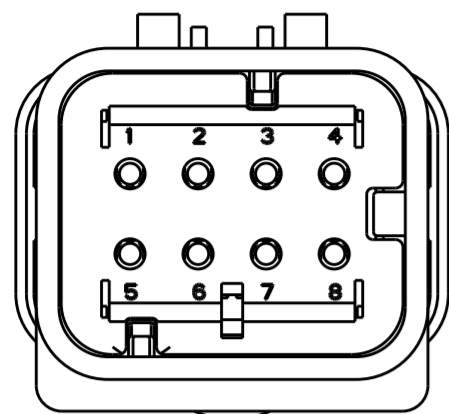

1717676-2
SCALE 2:1

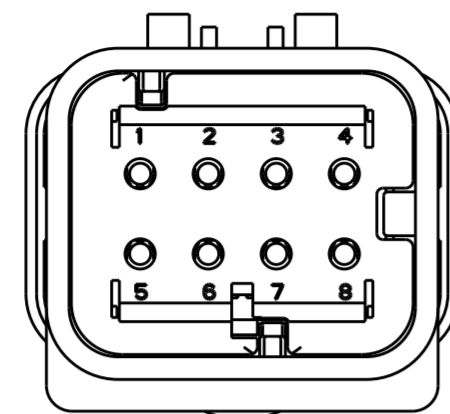

1717676-3
SCALE 2:1

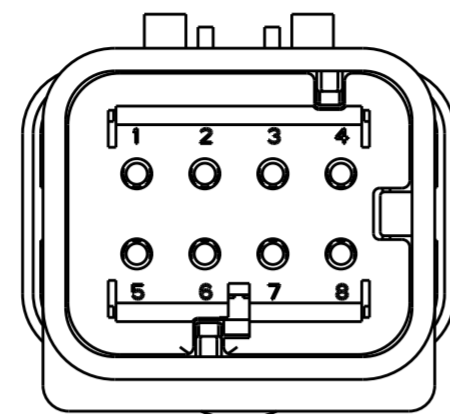

1717676-4
SCALE 2:1

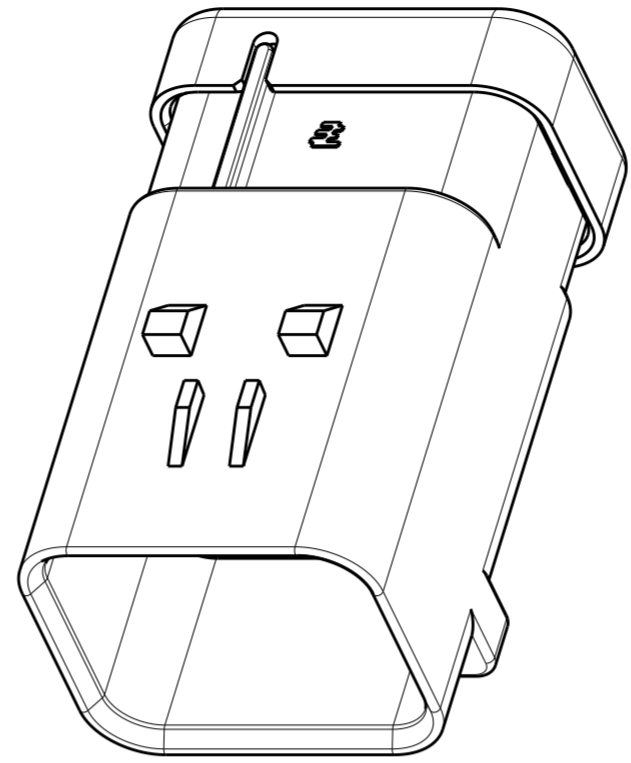

SCALE 2:1

- ① MATERIAL: 15% GLASS FILLED THERMOPLASTIC
COLOR: BLACK
- ② MATERIAL: 15% GLASS FILLED THERMOPLASTIC
COLOR: (SEE TABLE)
- ③ MATERIAL: SILICONE
COLOR: GREEN

4. WIRE INSULATION RANGE: $\varnothing 2.24 \sim \varnothing 3.94$

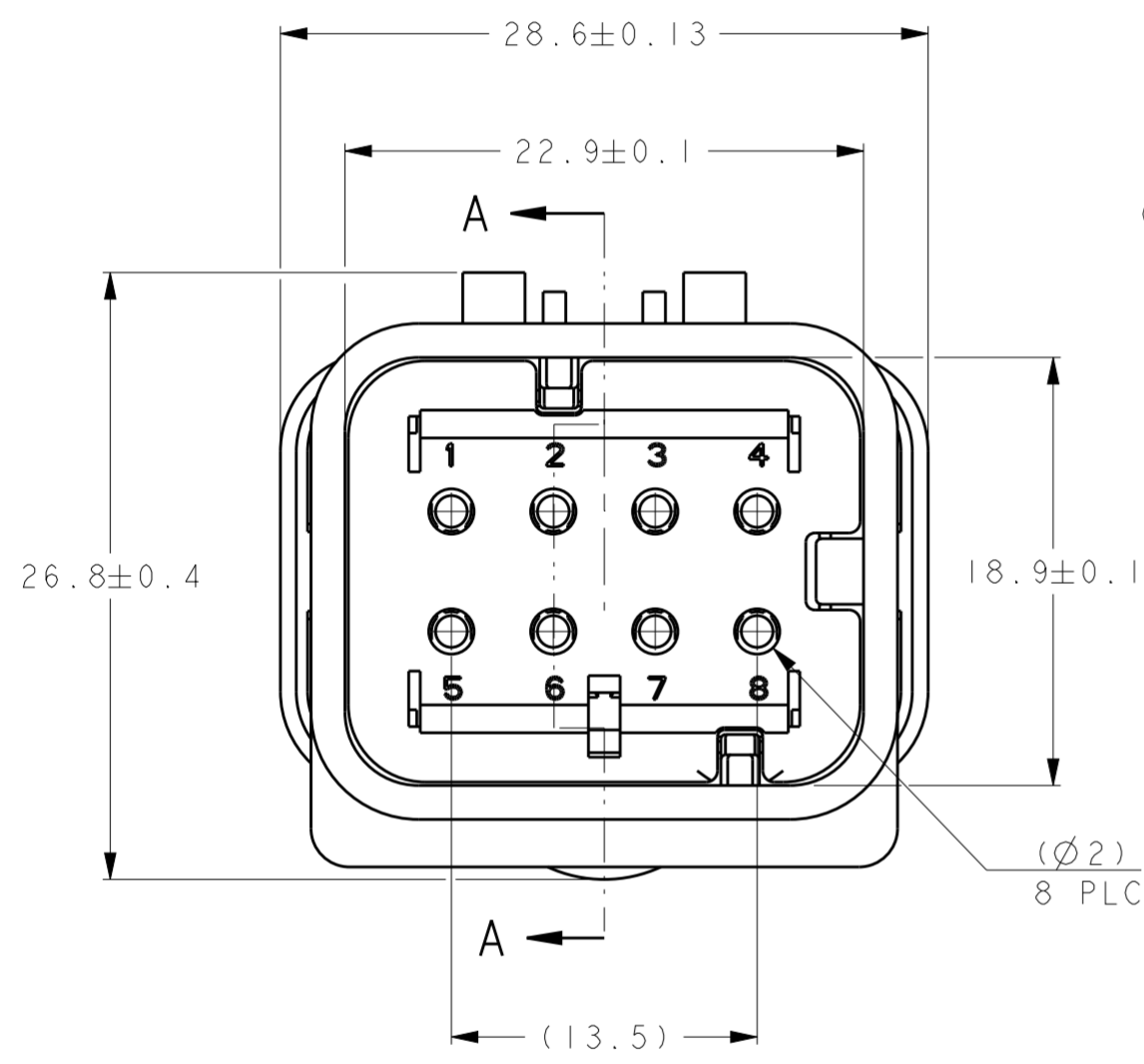

1717676-1 SHOWN

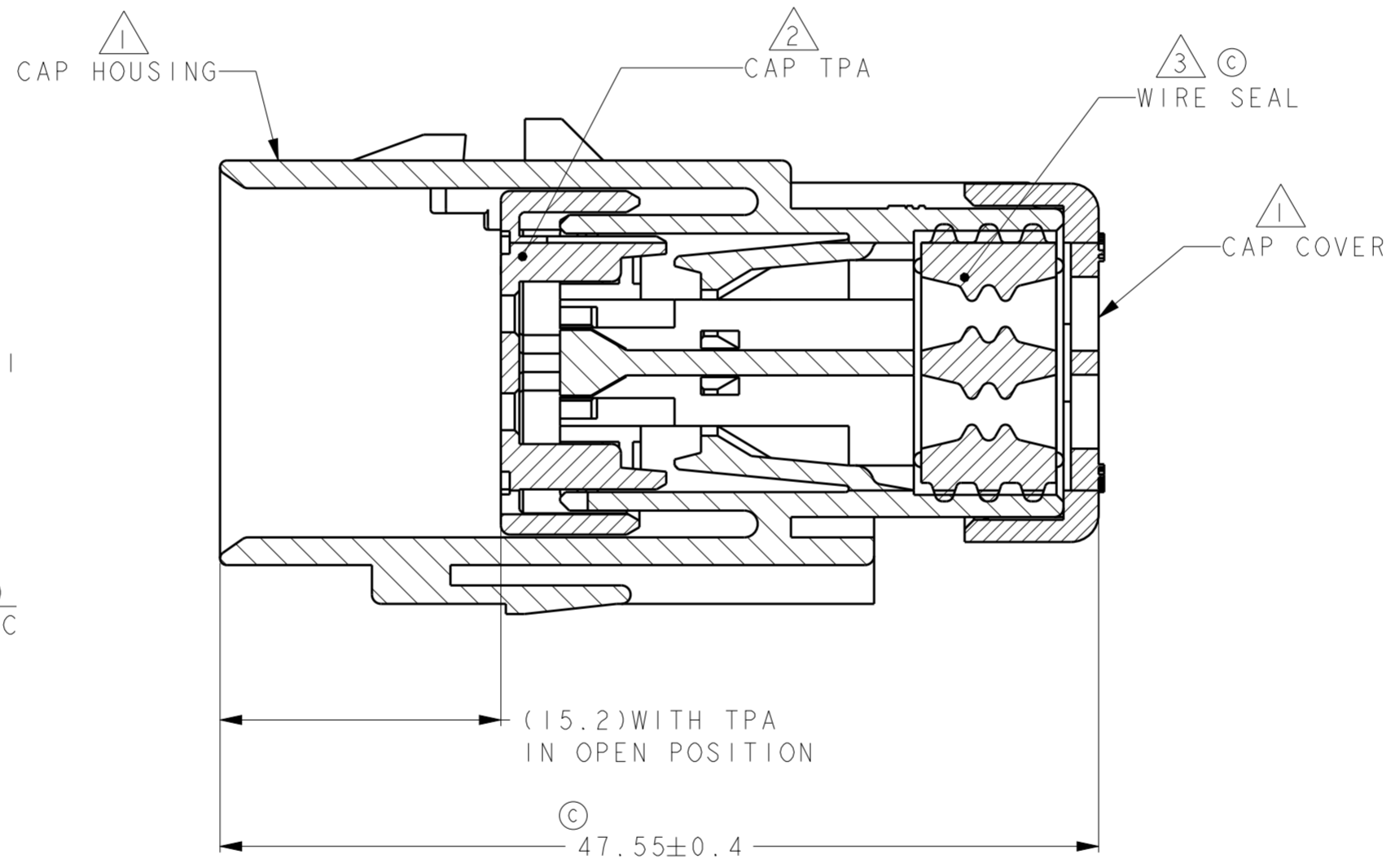

A - A
OPEN POSITION

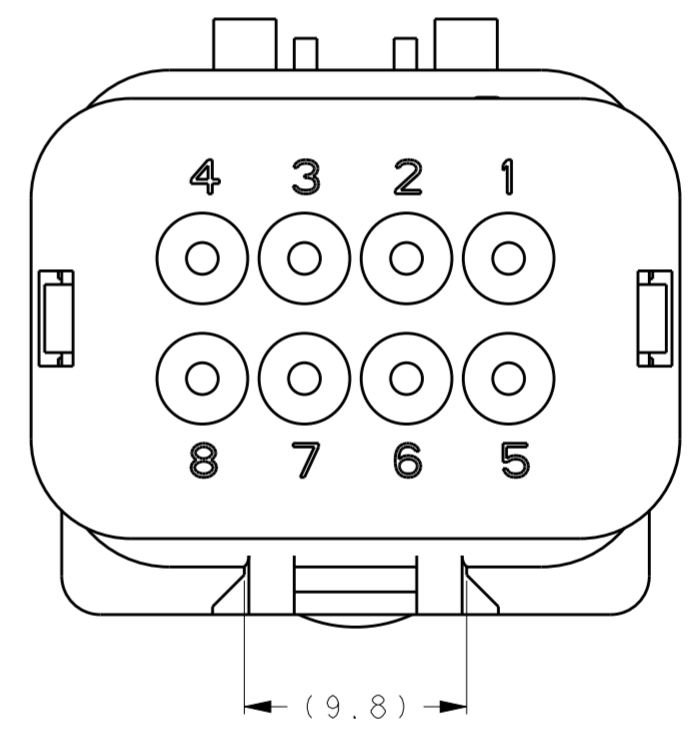

GREEN	1717676-4
YELLOW	1717676-3
GRAY	1717676-2
RED	1717676-1
TPA COLOR	PART NUMBER

THIS DRAWING IS A CONTROLLED DOCUMENT.		DWN Y. KATO	15JAN2004	STE TE Connectivity													
DIMENSIONS: mm		CHK S. MANABE	15JAN2004														
TOLERANCES UNLESS OTHERWISE SPECIFIED:		APVD S. MANABE	15JAN2004														
<table border="1"> <tr><td>0 PLC</td><td>±</td></tr> <tr><td>1 PLC</td><td>±0.5</td></tr> <tr><td>2 PLC</td><td>±0.13</td></tr> <tr><td>3 PLC</td><td>±0.013</td></tr> <tr><td>4 PLC</td><td>±0.0001</td></tr> <tr><td>ANGLES</td><td>±</td></tr> <tr><td>FINISH</td><td>-</td></tr> </table>		0 PLC	±		1 PLC	±0.5	2 PLC	±0.13	3 PLC	±0.013	4 PLC	±0.0001	ANGLES	±	FINISH	-	PRODUCT SPEC 108-2184
0 PLC	±																
1 PLC	±0.5																
2 PLC	±0.13																
3 PLC	±0.013																
4 PLC	±0.0001																
ANGLES	±																
FINISH	-																
MATERIAL TBD		APPLICATION SPEC 114-13065	SIZE A20779	DRAWING NO C-1717676													
		WEIGHT -	CAGE CODE A20779	RESTRICTED TO -													
CUSTOMER DRAWING			SCALE 3:1	SHEET 1 OF 1													
			REV C														