

MOSFET – Power, N-Channel, SUPERFET® III 800 V, 600 mΩ, 8 A

NTPF600N80S3Z

Description

800 V SUPERFET III MOSFET is ON Semiconductor's high performance MOSFET family offering 800 V breakdown voltage.

New 800 V SUPERFET III MOSFET which is optimized for primary switch of flyback converter, enables lower switching losses and case temperature without sacrificing EMI performance thanks to its optimized design. In addition, internal Zener Diode significantly improves ESD capability.

This new family of 800 V SUPERFET III MOSFET enables to make more efficient, compact, cooler and more robust applications because of its remarkable performance in switching power applications such as Laptop adapter, Audio, Lighting, ATX power and industrial power supplies.

Features

- Typ. $R_{DS(on)}$ = 550 mΩ
- Ultra Low Gate Charge (Typ. Q_g = 15.5 nC)
- Low Stored Energy in Output Capacitance (E_{oss} = 1.74 μJ @ 400 V)
- 100% Avalanche Tested
- ESD Improved Capability with Zener Diode
- RoHS Compliant

Applications

- Adapters / Chargers
- LED Lighting
- AUX Power
- Audio
- Industrial Power



ON Semiconductor®

www.onsemi.com

| $V_{(BR)DSS}$ | $R_{DS(ON)}$ MAX | I_D MAX |
|---------------|------------------|-----------|
| 800 V | 600 mΩ | 8 A |

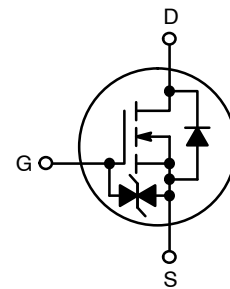

POWER MOSFET

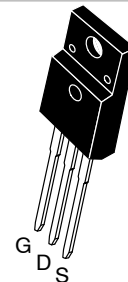

TO-220F
CASE 221D

MARKING DIAGRAM

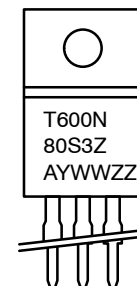

| | |
|------------|------------------------|
| T600N80S3Z | = Specific Device Code |
| A | = Assembly Location |
| Y | = Year |
| WW | = Work Week |
| ZZ | = Lot Code |

ORDERING INFORMATION

See detailed ordering and shipping information on page 2 of this data sheet.

NTPF600N80S3Z

ABSOLUTE MAXIMUM RATINGS ($T_J = 25^\circ\text{C}$, unless otherwise noted)

| Symbol | Parameter | Value | Unit |
|----------------|---|--|------------------|
| V_{DSS} | Drain-to-Source Voltage | 800 | V |
| V_{GS} | Gate-to-Source Voltage | DC | ± 20 |
| | | AC ($f > 1\text{ Hz}$) | ± 30 |
| I_D | Drain Current | Continuous ($T_C = 25^\circ\text{C}$) | 8* |
| | | Continuous ($T_C = 100^\circ\text{C}$) | 5* |
| I_{DM} | Drain Current | Pulsed (Note 1) | 21* |
| E_{AS} | Single Pulsed Avalanche Energy (Note 2) | 24 | mJ |
| I_{AS} | Avalanche Current (Note 2) | 1.2 | A |
| E_{AR} | Repetitive Avalanche Energy (Note 1) | 0.28 | mJ |
| dv/dt | MOSFET dv/dt | 100 | V/ns |
| | Peak Diode Recovery dv/dt (Note 3) | 10 | |
| P_D | Power Dissipation | ($T_C = 25^\circ\text{C}$) | 28 |
| | | Derate Above 25°C | 0.23 |
| T_J, T_{STG} | Operating and Storage Temperature Range | -55 to +150 | $^\circ\text{C}$ |
| T_L | Lead Temperature Soldering Reflow for Soldering Purposes (1/8" from Case for 10 seconds) | 260 | $^\circ\text{C}$ |

Stresses exceeding those listed in the Maximum Ratings table may damage the device. If any of these limits are exceeded, device functionality should not be assumed, damage may occur and reliability may be affected.

*Drain current limited by maximum junction temperature.

1. Repetitive rating: pulse-width limited by maximum junction temperature.
2. $I_{AS} = 1.2\text{ A}$, $R_G = 25\ \Omega$, starting $T_J = 25^\circ\text{C}$.
3. $I_{SD} \leq 2\text{ A}$, $di/dt \leq 200\text{ A}/\mu\text{s}$, $V_{DD} \leq 400\text{ V}$, starting $T_J = 25^\circ\text{C}$.

THERMAL RESISTANCE RATINGS

| Symbol | Parameter | Value | Unit |
|-----------------|------------------------------------|-------|---------------------------|
| $R_{\theta JC}$ | Junction-to-Case - Steady State | 4.4 | $^\circ\text{C}/\text{W}$ |
| $R_{\theta JA}$ | Junction-to-Ambient - Steady State | 62.5 | |

PACKAGE MARKING AND ORDERING INFORMATION

| Part Number | Top Marking | Package | Packaging Method | Reel Size | Tape Width | Quantity |
|---------------|---------------|---------|------------------|-----------|------------|----------|
| NTPF600N80S3Z | NTPF600N80S3Z | TO-220F | Tube | N/A | N/A | 50 Units |

NTPF600N80S3Z

ELECTRICAL CHARACTERISTICS ($T_J = 25^\circ\text{C}$ unless otherwise noted)

| Symbol | Parameter | Test Conditions | Min | Typ | Max | Unit |
|--------|-----------|-----------------|-----|-----|-----|------|
|--------|-----------|-----------------|-----|-----|-----|------|

OFF CHARACTERISTICS

| | | | | | | |
|--------------------------------|---|---|-----|-----|---|---------------------|
| BV_{DSS} | Drain-to-Source Breakdown Voltage | $V_{GS} = 0\text{ V}, I_D = 1\text{ mA}, T_J = 25^\circ\text{C}$ | 800 | | | V |
| | | $V_{GS} = 0\text{ V}, I_D = 1\text{ mA}, T_J = 150^\circ\text{C}$ | 900 | | | V |
| $\Delta BV_{DSS} / \Delta T_J$ | Drain-to-Source Breakdown Voltage Temperature Coefficient | $I_D = 1\text{ mA}$, Referenced to 25°C | | 1.1 | | V/ $^\circ\text{C}$ |
| I_{DSS} | Zero Gate Voltage Drain Current | $V_{DS} = 800\text{ V}, V_{GS} = 0\text{ V}$ | | | 1 | μA |
| | | $V_{DS} = 640\text{ V}, T_C = 125^\circ\text{C}$ | | 0.8 | | |
| I_{GSS} | Gate-to-Body Leakage Current | $V_{GS} = \pm 20\text{ V}, V_{DS} = 0\text{ V}$ | | | 1 | μA |

ON CHARACTERISTICS

| | | | | | | |
|--------------|--------------------------------------|--|-----|-----|-----|------------|
| $V_{GS(th)}$ | Gate Threshold Voltage | $V_{GS} = V_{DS}, I_D = 0.18\text{ mA}$ | 2.2 | | 3.8 | V |
| $R_{DS(on)}$ | Static Drain-to-Source On Resistance | $V_{GS} = 10\text{ V}, I_D = 4\text{ A}$ | | 550 | 600 | m Ω |
| g_{FS} | Forward Transconductance | $V_{DS} = 20\text{ V}, I_D = 4\text{ A}$ | | 9.4 | | S |

DYNAMIC CHARACTERISTICS

| | | | | | | |
|-----------------|-----------------------------------|---|--|------|--|----------|
| C_{iss} | Input Capacitance | $V_{DS} = 400\text{ V}, V_{GS} = 0\text{ V}, f = 250\text{ kHz}$ | | 725 | | pF |
| C_{oss} | Output Capacitance | | | 12 | | pF |
| $C_{oss(eff.)}$ | Effective Output Capacitance | $V_{DS} = 0\text{ V to } 400\text{ V}, V_{GS} = 0\text{ V}$ | | 139 | | pF |
| $C_{oss(er.)}$ | Energy Related Output Capacitance | $V_{DS} = 0\text{ V to } 400\text{ V}, V_{GS} = 0\text{ V}$ | | 21 | | pF |
| $Q_{g(tot)}$ | Total Gate Charge at 10 V | $V_{DD} = 400\text{ V}, I_D = 4\text{ A}, V_{GS} = 10\text{ V}$ (Note 4) | | 15.5 | | nC |
| Q_{gs} | Gate-to-Source Gate Charge | | | 3.1 | | nC |
| Q_{gd} | Gate-to-Drain "Miller" Charge | | | 5.1 | | nC |
| ESR | Equivalent Series Resistance | $f = 1\text{ MHz}$ | | 3.5 | | Ω |

SWITCHING CHARACTERISTICS

| | | | | | | |
|--------------|---------------------|---|--|------|--|----|
| $t_{d(on)}$ | Turn-On Delay Time | $V_{DD} = 400\text{ V}, I_D = 4\text{ A}, V_{GS} = 10\text{ V},$ $R_g = 4.7\ \Omega$ (Note 4) | | 12.3 | | ns |
| t_r | Turn-On Rise Time | | | 5.9 | | ns |
| $t_{d(off)}$ | Turn-Off Delay Time | | | 39.5 | | ns |
| t_f | Turn-Off Fall Time | | | 8.2 | | ns |

SOURCE-TO-DRAIN DIODE CHARACTERISTICS

| | | | | | | |
|----------|--|---|--|------|-----|---------------|
| I_S | Maximum Continuous Source-to-Drain Diode Forward Current | | | 8 | | A |
| I_{SM} | Maximum Pulsed Source-to-Drain Diode Forward Current | | | 21 | | A |
| V_{SD} | Source-to-Drain Diode Forward Voltage | $V_{GS} = 0\text{ V}, I_{SD} = 4\text{ A}$ | | | 1.2 | V |
| t_{rr} | Reverse Recovery Time | $V_{GS} = 0\text{ V}, I_{SD} = 2\text{ A},$ $di_F/dt = 100\text{ A}/\mu\text{s}$ | | 137 | | ns |
| Q_{rr} | Reverse Recovery Charge | | | 0.91 | | μC |

Product parametric performance is indicated in the Electrical Characteristics for the listed test conditions, unless otherwise noted. Product performance may not be indicated by the Electrical Characteristics if operated under different conditions.

4. Essentially independent of operating temperature typical characteristics.

SUPERFET is a registered trademark of Semiconductor Components Industries, LLC (SCILLC) or its subsidiaries in the United States and/or other countries.

NTPF600N80S3Z

TYPICAL CHARACTERISTICS

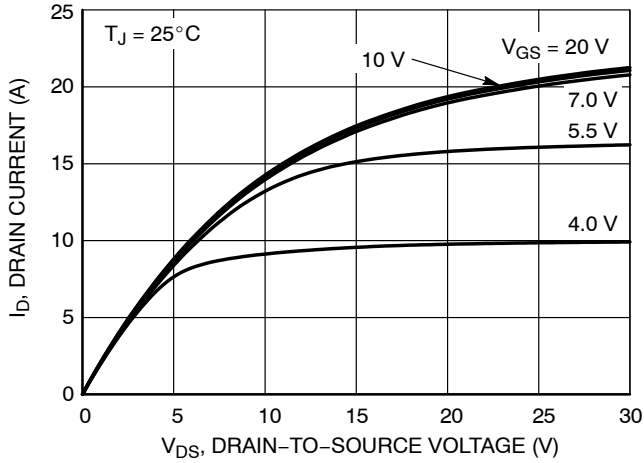

Figure 1. On-Region Characteristics

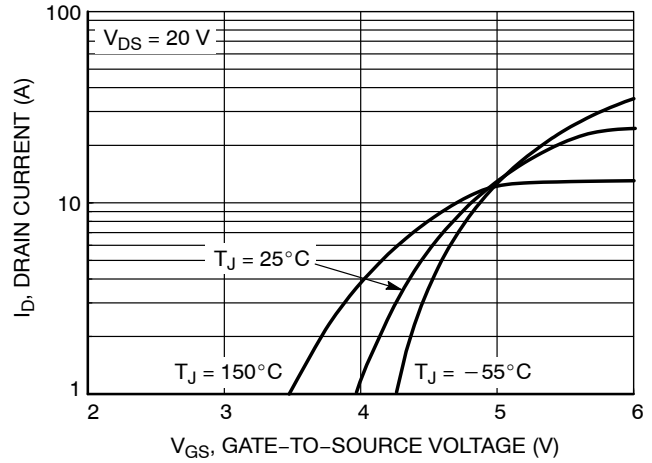

Figure 2. Transfer Characteristics

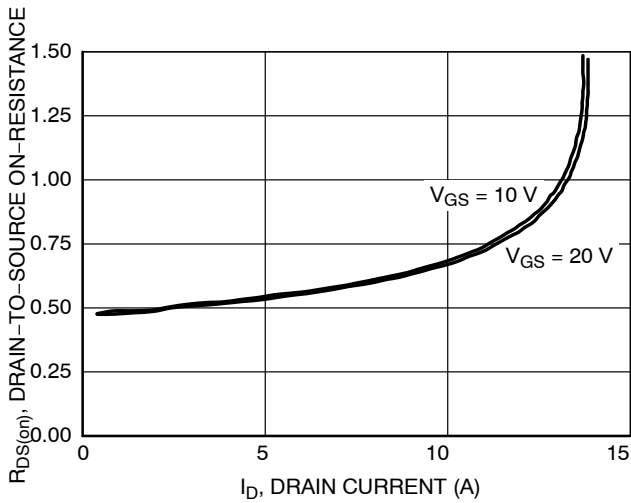

Figure 3. On Resistance vs. Drain Current

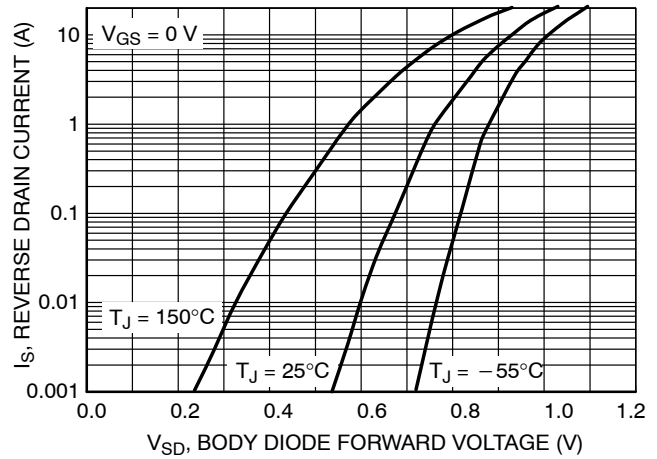

Figure 4. Diode Forward Voltage vs. Current

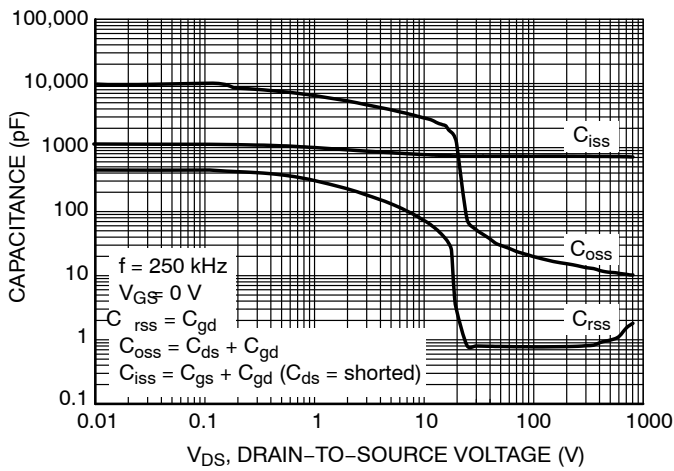

Figure 5. Capacitance Characteristics

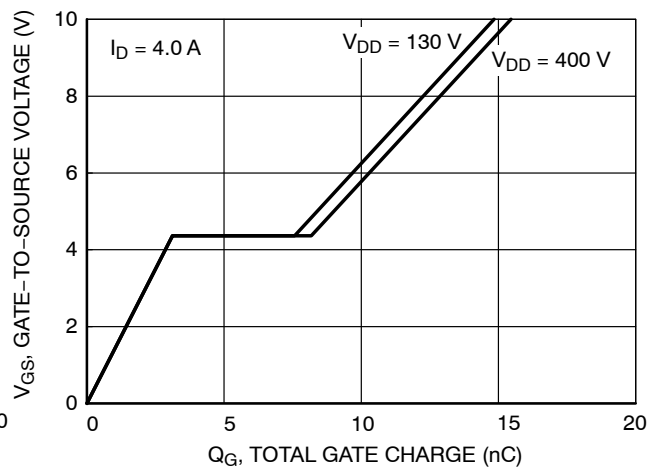

Figure 6. Gate Charge Characteristics

NTPF600N80S3Z

TYPICAL CHARACTERISTICS

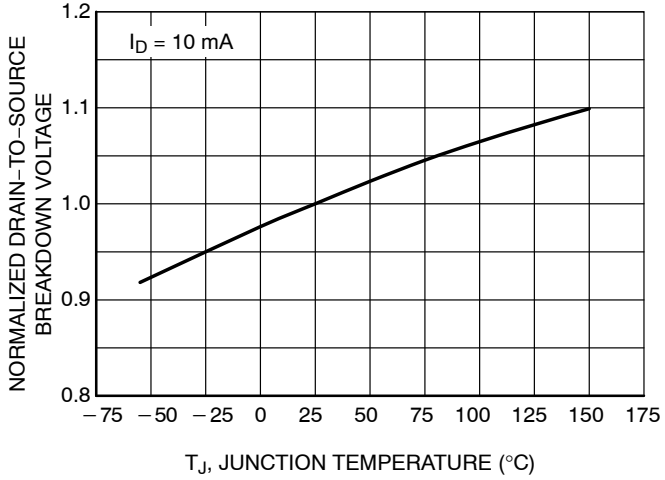

Figure 7. Normalized BV_{DSS} vs. Temperature

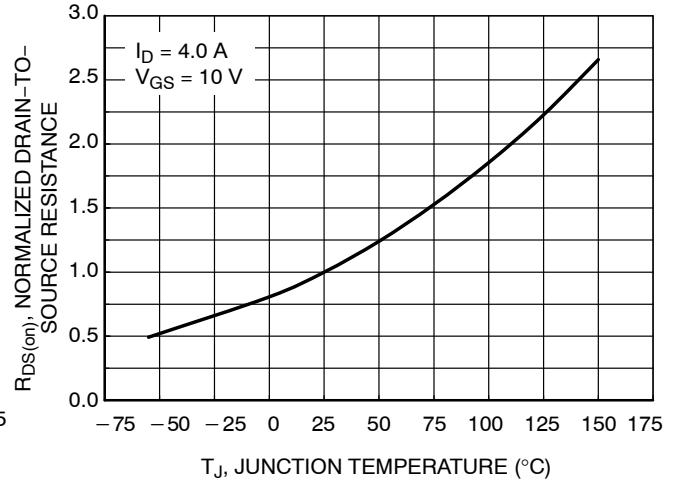

Figure 8. On-Resistance Variation vs. Temperature

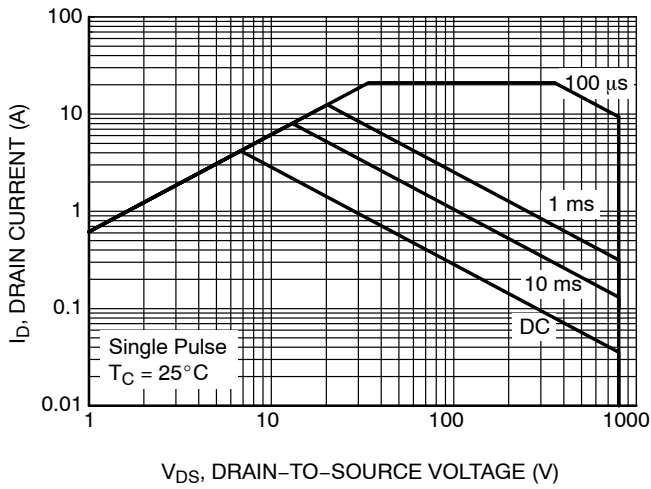

Figure 9. Safe Operating Area

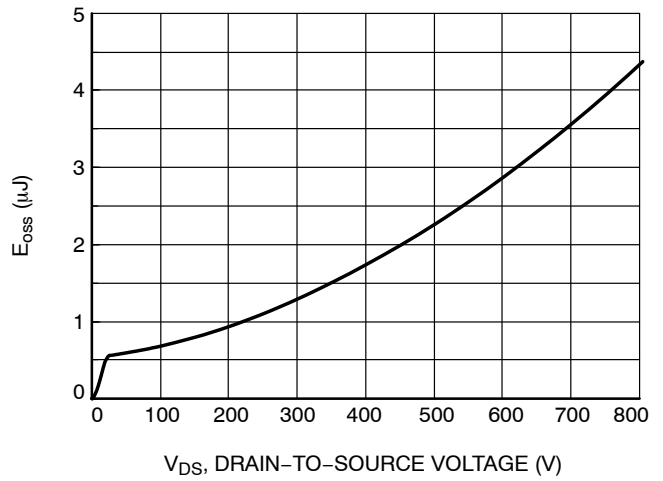

Figure 10. E_{OSS} vs. Drain-to-Source Voltage

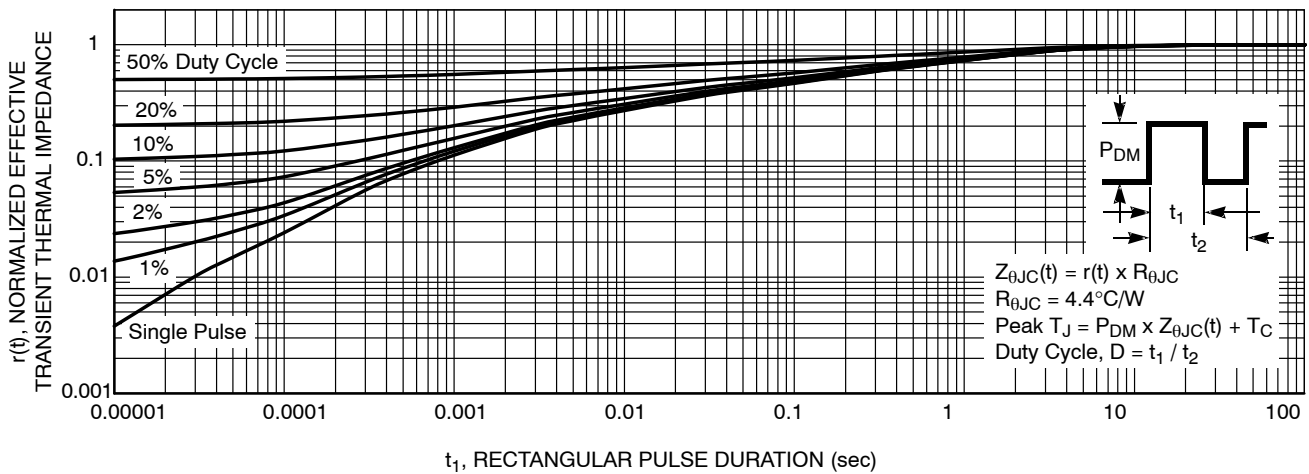

Figure 11. Transient Thermal Impedance

NTPF600N80S3Z

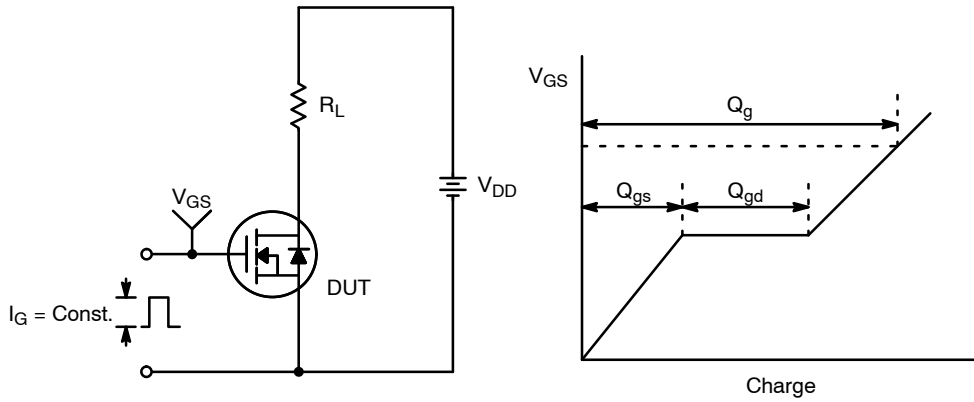

Figure 12. Gate Charge Test Circuit & Waveform

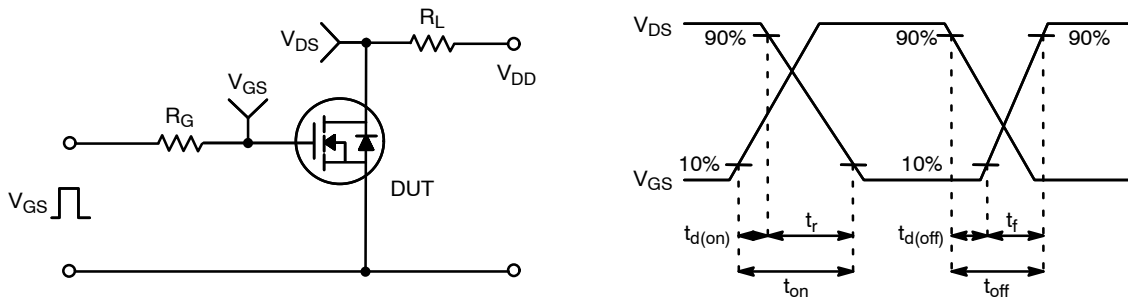

Figure 13. Resistive Switching Test Circuit & Waveforms

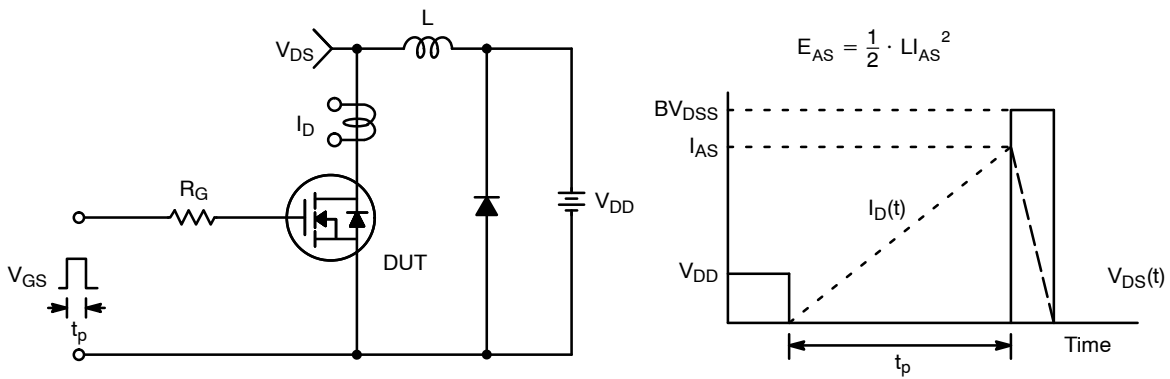

Figure 14. Unclamped Inductive Switching Test Circuit & Waveforms

NTPF600N80S3Z

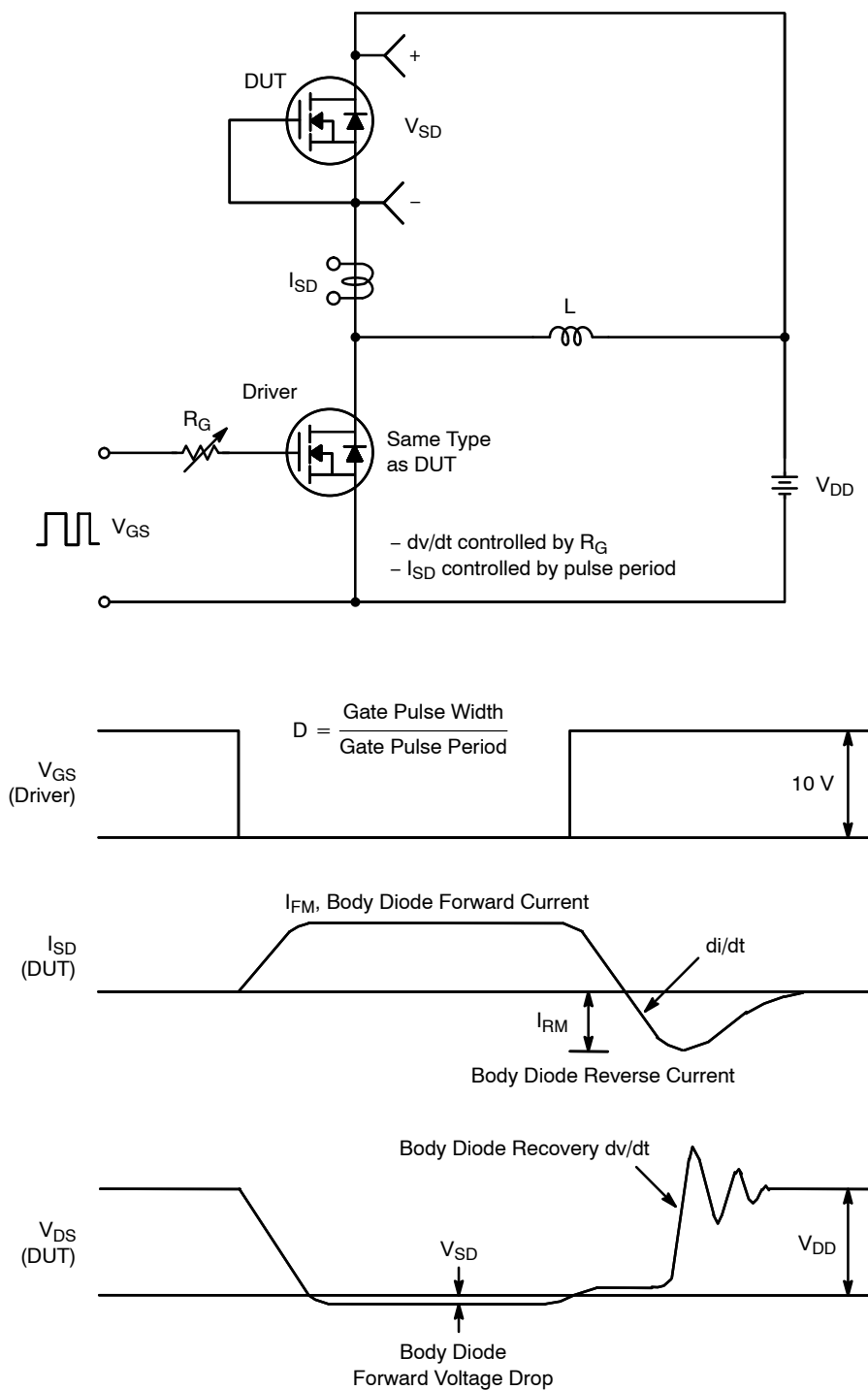
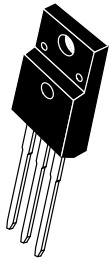

Figure 15. Peak Diode Recovery dv/dt Test Circuit & Waveforms

MECHANICAL CASE OUTLINE PACKAGE DIMENSIONS



SCALE 1:1

TO-220 FULLPAK CASE 221D-03 ISSUE K

DATE 27 FEB 2009

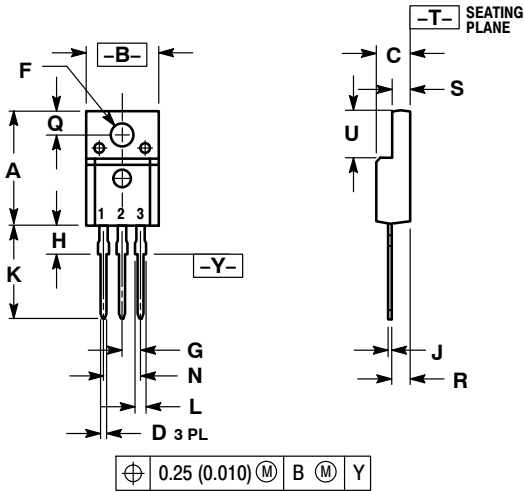

- NOTES:
- DIMENSIONING AND TOLERANCING PER ANSI Y14.5M, 1982.
 - CONTROLLING DIMENSION: INCH
 - 221D-01 THRU 221D-02 OBSOLETE, NEW STANDARD 221D-03.

| DIM | INCHES | | MILLIMETERS | |
|-----|-----------|-------|-------------|-------|
| | MIN | MAX | MIN | MAX |
| A | 0.617 | 0.635 | 15.67 | 16.12 |
| B | 0.392 | 0.419 | 9.96 | 10.63 |
| C | 0.177 | 0.193 | 4.50 | 4.90 |
| D | 0.024 | 0.039 | 0.60 | 1.00 |
| F | 0.116 | 0.129 | 2.95 | 3.28 |
| G | 0.100 BSC | | 2.54 BSC | |
| H | 0.118 | 0.135 | 3.00 | 3.43 |
| J | 0.018 | 0.025 | 0.45 | 0.63 |
| K | 0.503 | 0.541 | 12.78 | 13.73 |
| L | 0.048 | 0.058 | 1.23 | 1.47 |
| N | 0.200 BSC | | 5.08 BSC | |
| Q | 0.122 | 0.138 | 3.10 | 3.50 |
| R | 0.099 | 0.117 | 2.51 | 2.96 |
| S | 0.092 | 0.113 | 2.34 | 2.87 |
| U | 0.239 | 0.271 | 6.06 | 6.88 |

MARKING DIAGRAMS

- | | | |
|--|---|--|
| STYLE 1: PIN 1. GATE 2. DRAIN 3. SOURCE | STYLE 2: PIN 1. BASE 2. COLLECTOR 3. EMITTER | STYLE 3: PIN 1. ANODE 2. CATHODE 3. ANODE |
| STYLE 4: PIN 1. CATHODE 2. ANODE 3. CATHODE | STYLE 5: PIN 1. CATHODE 2. ANODE 3. GATE | STYLE 6: PIN 1. MT 1 2. MT 2 3. GATE |



Bipolar

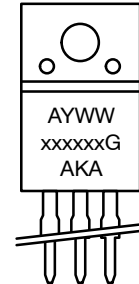

Rectifier

- | | |
|-------------------------------|---------------------------|
| xxxxxx = Specific Device Code | A = Assembly Location |
| G = Pb-Free Package | Y = Year |
| A = Assembly Location | WW = Work Week |
| Y = Year | xxxxxx = Device Code |
| WW = Work Week | G = Pb-Free Package |
| | AKA = Polarity Designator |

| | | |
|-------------------------|-----------------------|--|
| DOCUMENT NUMBER: | 98ASB42514B | Electronic versions are uncontrolled except when accessed directly from the Document Repository. Printed versions are uncontrolled except when stamped "CONTROLLED COPY" in red. |
| DESCRIPTION: | TO-220 FULLPAK | PAGE 1 OF 1 |

ON Semiconductor and are trademarks of Semiconductor Components Industries, LLC dba ON Semiconductor or its subsidiaries in the United States and/or other countries. ON Semiconductor reserves the right to make changes without further notice to any products herein. ON Semiconductor makes no warranty, representation or guarantee regarding the suitability of its products for any particular purpose, nor does ON Semiconductor assume any liability arising out of the application or use of any product or circuit, and specifically disclaims any and all liability, including without limitation special, consequential or incidental damages. ON Semiconductor does not convey any license under its patent rights nor the rights of others.

onsemi, **Onsemi**, and other names, marks, and brands are registered and/or common law trademarks of Semiconductor Components Industries, LLC dba "**onsemi**" or its affiliates and/or subsidiaries in the United States and/or other countries. **onsemi** owns the rights to a number of patents, trademarks, copyrights, trade secrets, and other intellectual property. A listing of **onsemi**'s product/patent coverage may be accessed at www.onsemi.com/site/pdf/Patent-Marking.pdf. **onsemi** reserves the right to make changes at any time to any products or information herein, without notice. The information herein is provided "as-is" and **onsemi** makes no warranty, representation or guarantee regarding the accuracy of the information, product features, availability, functionality, or suitability of its products for any particular purpose, nor does **onsemi** assume any liability arising out of the application or use of any product or circuit, and specifically disclaims any and all liability, including without limitation special, consequential or incidental damages. Buyer is responsible for its products and applications using **onsemi** products, including compliance with all laws, regulations and safety requirements or standards, regardless of any support or applications information provided by **onsemi**. "Typical" parameters which may be provided in **onsemi** data sheets and/or specifications can and do vary in different applications and actual performance may vary over time. All operating parameters, including "Typicals" must be validated for each customer application by customer's technical experts. **onsemi** does not convey any license under any of its intellectual property rights nor the rights of others. **onsemi** products are not designed, intended, or authorized for use as a critical component in life support systems or any FDA Class 3 medical devices or medical devices with a same or similar classification in a foreign jurisdiction or any devices intended for implantation in the human body. Should Buyer purchase or use **onsemi** products for any such unintended or unauthorized application, Buyer shall indemnify and hold **onsemi** and its officers, employees, subsidiaries, affiliates, and distributors harmless against all claims, costs, damages, and expenses, and reasonable attorney fees arising out of, directly or indirectly, any claim of personal injury or death associated with such unintended or unauthorized use, even if such claim alleges that **onsemi** was negligent regarding the design or manufacture of the part. **onsemi** is an Equal Opportunity/Affirmative Action Employer. This literature is subject to all applicable copyright laws and is not for resale in any manner.

ADDITIONAL INFORMATION

TECHNICAL PUBLICATIONS:

Technical Library: www.onsemi.com/design/resources/technical-documentation
onsemi Website: www.onsemi.com

ONLINE SUPPORT: www.onsemi.com/support

For additional information, please contact your local Sales Representative at www.onsemi.com/support/sales