

Crimp Quality Monitor II

Part number 2359600-1

General information

- The information provided is intended solely for product description purposes. Users must carry out their own assessments and tests. Our products are subject to natural wear and aging processes.
- All rights are retained by TE Connectivity (TE) in case of applications for protective rights. We reserve all rights of disposal, such as copying and transfer rights.
- The front cover shows a sample configuration. The supplied product may vary from what is shown.
- This operating manual is only intended for internal use by the user of the crimping machine for FFC and F crimping (referred to herein as "FFC-FFC-CM") and their personnel.
- The relevant supplementary operating manual contains descriptions, technical drawings, specifications and instructions, no part of which may be reproduced, circulated, disclosed, or used for the purpose of competition without permission.
- Should third parties endeavor to gain access to this operating manual, the same fairness is expected from you as you would expect from your customers in such cases.
- All rights reserved, including the granting of patents or other registrations. Subject to technical changes.

© Copyright 2023 TE Connectivity Ltd. family of companies. All rights reserved.

TE Connectivity, TE Connectivity (logo), and TE (logo) are trademarks. Other logos and product or company names may be trademarks of their respective owners.

PRODUCT INFORMATION 1-800-522-6752

This controlled document is subject to change.

For the latest revision and Regional Customer Service, visit our website at www.te.com.

Contents

| | | |
|-------|---|----|
| 1 | Introduction..... | 7 |
| 2 | Description | 10 |
| 2.1 | Screen description | 10 |
| 2.2 | Menu Bar | 10 |
| 2.3 | Control Panel Screen | 11 |
| 2.4 | Help | 13 |
| 2.5 | Screen Information | 13 |
| 2.6 | Graphing Information..... | 13 |
| 2.7 | Task Bar | 13 |
| 2.8 | Definitions | 14 |
| 2.8.1 | Headroom (and how it affects crimps)..... | 14 |
| 2.8.2 | Crimp Height..... | 14 |
| 2.8.3 | Work index..... | 15 |
| 2.8.4 | Peak force..... | 15 |
| 2.8.5 | Point-to-point (P2P) analysis | 15 |
| 2.8.6 | Fast Fourier transform (FFT) analysis | 15 |
| 2.8.7 | Force Only Mode | 15 |
| 3 | Receiving, inspection, and installation | 16 |
| 3.1 | Receiving and inspecting..... | 16 |
| 3.2 | Installation..... | 16 |
| 3.3 | System settings | 17 |
| 3.4 | CQM settings | 17 |
| 3.4.1 | Setup Tab | 18 |
| 3.4.2 | Position Sensor Tab | 19 |
| 3.4.3 | Force Sensor Tab | 20 |
| 3.4.4 | Sensor Calibration Tab | 20 |
| 3.4.5 | Learn Tab | 21 |
| 3.4.6 | Control Limit Tab | 22 |
| 3.4.7 | Graphing Tab..... | 22 |
| 4 | Production run setup | 23 |
| 4.1 | Options | 23 |
| 4.2 | Work Order | 23 |
| 4.3 | Order Size..... | 24 |
| 4.4 | Part | 24 |
| 4.5 | Analysis Methods..... | 25 |
| 4.6 | Crimp Height..... | 26 |
| 4.7 | Peak Force (PF) and Work Index (WI) Sensitivity | 27 |

| | | |
|--------|---|----|
| 4.8 | Point to Point (P2P) / FFT Sensitivity | 28 |
| 4.9 | Sample..... | 29 |
| 4.10 | Calibrate | 30 |
| 4.11 | Learn..... | 31 |
| 5 | Production | 33 |
| 5.1 | Basic Screen..... | 34 |
| 5.2 | Status..... | 35 |
| 5.3 | Crimp Height..... | 36 |
| 5.4 | Work Index..... | 37 |
| 5.5 | Peak Force | 38 |
| 5.6 | P2P | 39 |
| 5.7 | FFT | 40 |
| 6 | Control panel | 41 |
| 6.1 | Language icon | 41 |
| 6.2 | Login/Logout..... | 41 |
| 6.3 | Users | 42 |
| 6.3.1 | Add New User..... | 42 |
| 6.3.2 | Change Password | 42 |
| 6.3.3 | Delete | 42 |
| 6.3.4 | Permission Settings..... | 43 |
| 6.4 | Locale Settings | 45 |
| 6.4.1 | Date/Time Settings | 46 |
| 6.4.2 | Reports | 47 |
| 6.4.3 | Report Setup..... | 54 |
| 6.4.4 | Curve History Graph | 54 |
| 6.4.5 | Network..... | 55 |
| 6.4.6 | Display Settings | 57 |
| 6.4.7 | Calibrate Touchscreen..... | 58 |
| 6.4.8 | Maintenance | 59 |
| 6.4.9 | Diagnostics | 63 |
| 6.4.10 | Error Log Viewer..... | 67 |
| 6.4.11 | Demo | 68 |
| 6.4.12 | Printer Icon | 68 |
| 7 | Troubleshooting..... | 70 |
| 7.1 | Additional information for specific sensors | 71 |
| 7.1.1 | Linear Encoder | 71 |
| 7.1.2 | Analog Height Sensor..... | 71 |
| 7.1.3 | Base Plate Strain Gage (Force Sensor) | 72 |

| | | |
|-------|--|----|
| 7.1.4 | Piezo Sensor (Force Sensor) | 72 |
| 7.1.5 | Trigger Sensor (on non-TE terminators)..... | 72 |
| 8 | Maintenance | 73 |
| 8.1 | Touch screen cleaning | 73 |
| 8.2 | Daily maintenance | 73 |
| 8.3 | Special handling precautions for systems with the linear encoder installed | 73 |
| 8.4 | Quality control maintenance | 74 |
| 9 | Evaluation and repair | 74 |
| 10 | Revision summary | 74 |

SAFETY PRECAUTIONS — AVOID INJURY — READ THIS FIRST!



NOTE

Keep all decals clean and legible. Replace them when necessary.



**DANGER
ELECTRIC SHOCK HAZARD**

This tool is not insulated. When using this unit near energized electrical lines, use proper personal protective equipment.



Failure to observe this warning could result in severe injury or death.



DANGER

Denotes an imminent hazard that can result in moderate or severe injury.



SKIN INJECTION HAZARD

Do not use hands to check for oil leaks. Highly pressurized oil punctures the skin, causing serious injury, gangrene, or death. If injured, seek immediate medical help to remove the oil.



**DANGER
FIRE HAZARD**

Do not use solvents or flammable liquids to clean the crimping tool. Solvents or flammable liquids could ignite and cause serious injury or property damage.



Failure to heed these warnings could result in severe injury from harmful fumes or burns from flying debris.



DANGER

Inspect the tool and jaws/dies before each use. Replace any worn or damaged parts. A damaged or improperly assembled tool can break and strike nearby personnel.

Failure to observe this warning could result in severe injury or death.



CAUTION

Do not place the tool in a vise. The crimping tool is designed for hand-held operation.

Protect the crimping tool from rain and moisture. Water damages the crimping tool and battery.

Failure to observe these precautions can result in injury or property damage.



CAUTION

Do not perform any service or maintenance other than as described in this manual. Injury or damage to the tool can result.

Failure to observe these precautions can result in injury or property damage.

Safeguards are designed into this application equipment to protect operators and maintenance personnel from most hazards during equipment operation. However, certain safety precautions must be taken by the operator and repair personnel to avoid personal injury, as well as damage to the equipment. For best results, application equipment must be operated in a dry, dust-free environment. Do not operate equipment in a gaseous or hazardous environment.

Carefully observe the following safety precautions before and during operation of the equipment:



Always wear approved eye protection while operating equipment.



Always wear appropriate ear protection while using equipment.



Moving parts can crush and cut. Always keep guards in place during normal operation.



Electrical shock hazard.



Always turn off the main power switch and disconnect the electrical cord from the power source when performing repair or maintenance on the equipment.



Always turn off the main power switch and disconnect the electrical cord from the power source when performing repair or maintenance on the equipment.



Never alter, modify, or misuse the equipment.



Do not operate equipment if the guards are removed.





Read and understand this entire document before using equipment.

1 Introduction

Crimp Quality Monitor II (CQM II, Figure 1) provides immediate inspection of the crimp height and the work curve of a crimp by analysis of data provided by force and position sensors. The sensors can be built into special CQM II applicators or installed into the terminating machine. The CQM II uses visual cues to notify the operator when faulty crimps occur.

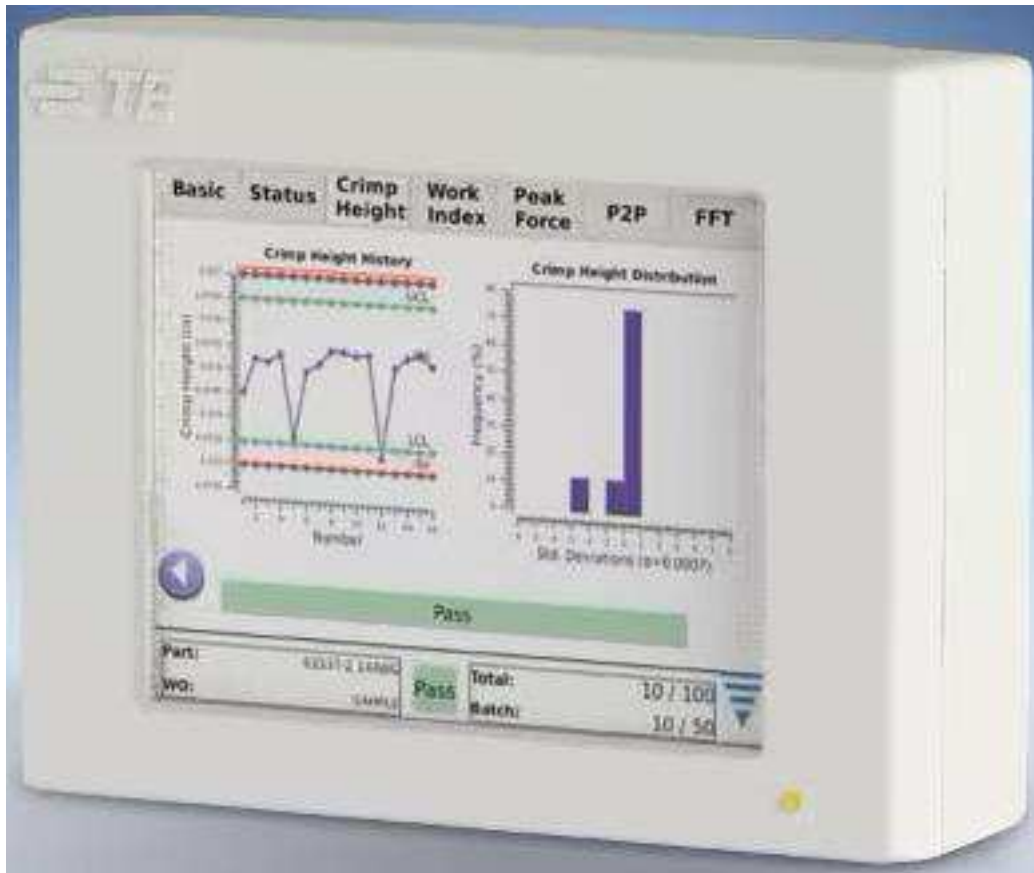
Figure 1: Crimp Quality Monitor II



 **CAUTION**
Do not use any metal object as a stylus on the touch screen.

 **NOTE**
The CQM II is a **process** monitor. It is influenced by many variables, including changes in wire, terminal, applicator terminal condition, operator, and environment. Changes in any of these variables can affect the process, which must be re-learned.

The CQM II was designed for many machines, but when it is installed on an AMP-O-ELECTRIC™ Model G Terminating Machine (Figure 2) equipped with the crimp height adjustment motor, the CQM II automatically adjusts the crimp height to keep the process at nominal.

The CQM's operation, functions, screens, and touchscreen inputs are detailed in this document. Refer to customer manuals and instructions shipped with the application equipment for machine information.

Figure 2: HV-20 Terminating Machine

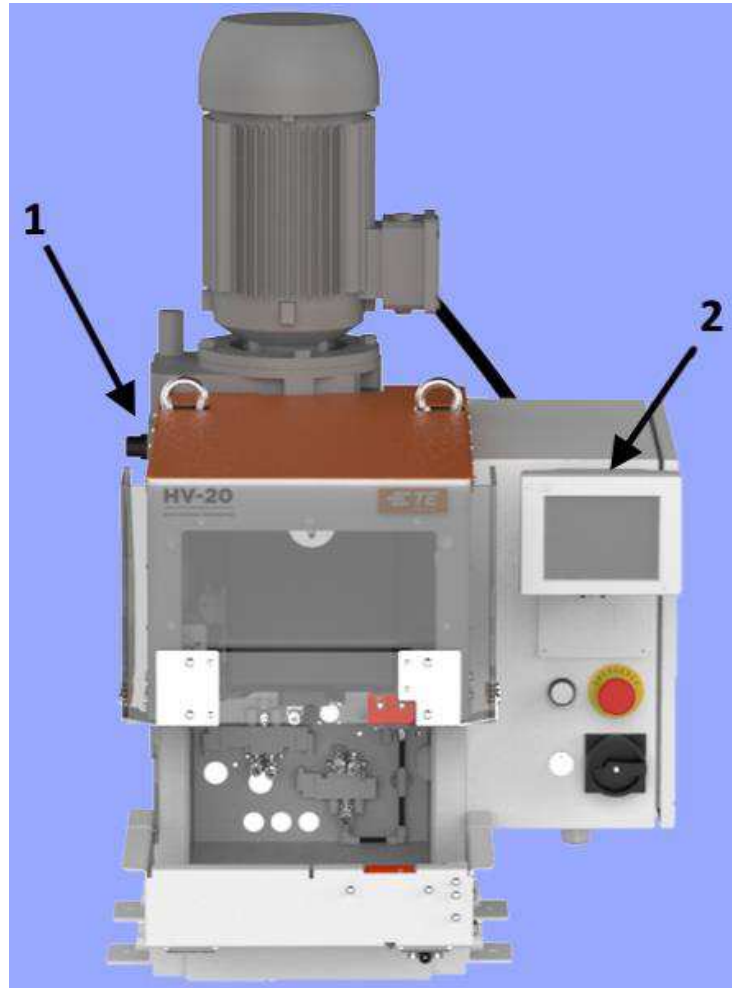

1 HV-20 Terminating Machine

2 CQM II

The specifications for the CQM II are listed in Table 1, Table 2, and Table 3.

Table 1: Electrical

| | |
|--|--|
| Operating voltage (DC power supply) | 100-240 VAC, 50/60 Hz, 1.5 amps (max.) |
| Host and DAQ (data acquisition) operating voltage | 24 VDC |

Table 2: Ambient operating environment

| | |
|--------------------------|----------------------|
| Temperature | 5-40° C [40-104° F] |
| Relative humidity | < 95% non-condensing |

Table 3: Sensors

| | |
|--------------------------|--|
| Force strain gage | Wheatstone bridge force sensor |
| Force piezo | ICP low impedance quartz force sensor |
| Displacement | Analog hall effect sensor |
| | Linear quadrature encoder (5Vdc, 2 micron) |

Inputs/outputs: Four programmable outputs for machine interface.



NOTE

Use the AC power cord that is appropriate with your country's power system (typically included with the system). Ensure that the cord is plugged into a circuit that has over-current protection of no greater than 15-20 amps (country dependent).

To best use the machine and manual, complete the following steps.

1. Open the package.
2. Inspect the contents.
3. Install the machine (using drawings and 408 instructions).
4. Configure the machine as described in section 3.3.
5. Set up the machine for production operation.

2 Description

2.1 Screen description

Many of the screens are designed to walk the operator through the crimping process with a series of arrows and headings.

2.2 Menu Bar

Icons on the menu bar (Figure 3) are used to access the home screen (Work Order Screen), Help, Control Panel, Back Arrow (to go to the previous screen), and a menu collapse arrow. The menu collapses automatically if the screen is not touched for five seconds.

Figure 3: Menu bar



- | | | | |
|----------|-----------------------------|----------|---------------------|
| 1 | Back arrow | 5 | To Control Panel |
| 2 | Home screen | 6 | Time and date |
| 3 | Help | 7 | Menu collapse arrow |
| 4 | Screen name [screen number] | | |

A series of icons guides you through the use of this monitor. Table 4 lists the buttons and icons you will need to use, including the edit icon, the delete icon, and the radio buttons.

Table 4: Buttons and icons

| Button or icon | Description |
|----------------|---------------------------|
| | Back arrow |
| | Menu collapse arrow |
| | Edit icon |
| | Delete icon |
| | Radio button (selected) |
| | Radio button (deselected) |

2.3 Control Panel Screen

Table 5: What icons do

| Icon | What it does | Refer to |
|-------------------------------|--|----------------|
| Control Panel | Control Panel screen | Figure 4 |
| Language | Selecting the appropriate language | Section 6.1 |
| Login/logoff | Allows the user to “log in” to the machine, and to “log off” the machine | Section 6.2 |
| Users | Allows the addition and deletion of users | Section 0 |
| Reports | Allows access to the statistics report and raw production data | Section 6.4.2 |
| Report Setup | Allows the administrator to set up reports | Section 0 |
| Curve History Graph | Curve history graphs | Section 6.4.4 |
| System Settings | Allows the administrator to configure the system | Section 3.3 |
| CQM Settings | Allows the administrator to configure the CQM settings | Section 3.4 |
| Diagnostics | Allows access to inputs, outputs, and sensor and temperature readings | Section 6.4.9 |
| Error Log Viewer | allows the CQM errors to be viewed by time and date | Section 6.4.10 |
| Maintenance | maintenance screens for the CQM | Section 0 |
| Calibrate Touch Screen | allows the settings of the touch screen to be calibrated | Section 0 |
| Display Settings | provides access to adjust the display settings | Section 0 |
| Printer | allows the user to add local or network printers | Section 6.4.12 |
| Network | allows the user to configure a network connection to the CQM | Section 0 |
| Date/Time | screens in which the date (and style of date) and the time (and style of time) can be chosen | Section 6.4.1 |
| Locale | a screen resulting in the selection of the operating locale | Section 0 |
| Demo | demonstration of the CQM | Section 6.4.11 |

Figure 4: Control Panel screen

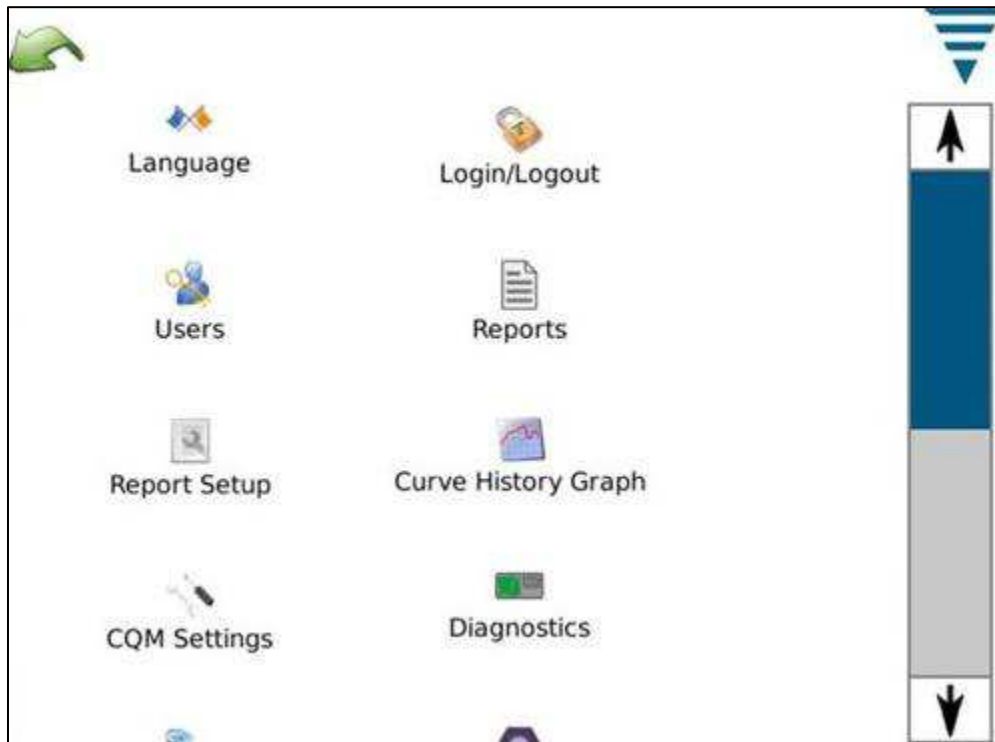

The screen also contains a back arrow and menu collapse arrow button (

Figure 4).



NOTE
User access can be set in the Users (icon) portion of the control panel.

2.4 Help

On any screen, touching the help icon displays relevant information from the CQM II manual.

2.5 Screen Information

If you touch a numeric field, a keypad is displayed. The keypad is specific to the information being entered. It displays the allowable ranges for most numeric entries.

If the field turns red, the value is out of range, incorrect, or (in some cases) not filled in.

A temporary unit change to switch from inch to metric, or metric to inch entry is on the keypad.

2.6 Graphing Information

Touching a graph expands it to full screen. Use the left and right arrows to scroll through some graphics.

Touching the Print/File icon creates a PDF that can be printed (if a printer is attached and configured) or saved to a USB flash drive.

On crimp curves, the graph can be zoomed. Touch the display and drag your finger to create a red box that selects the area to be zoomed.

To return to the full display, touch the paper icon. To return to the previous level, touch the magnifying glass (with negative sign) icon.

2.7 Task Bar

When not in the control panel, a Task bar at the bottom of the display guides you through the production crimping process. Some selections expand to provide additional choices for parameter editing. Following the arrows leads you from the start of setting up a work order all the way to production.

By touching the **Previous task** and **Next task** buttons (Figure 5), you can go back to the previous task or advance to the next. You can also go directly to a specific task by touching the corresponding button. These buttons enable you to skip steps or go back to others. However, if a step is required, you cannot go beyond that step until you have completed it. A message describes the required action.

Figure 5: Task bar

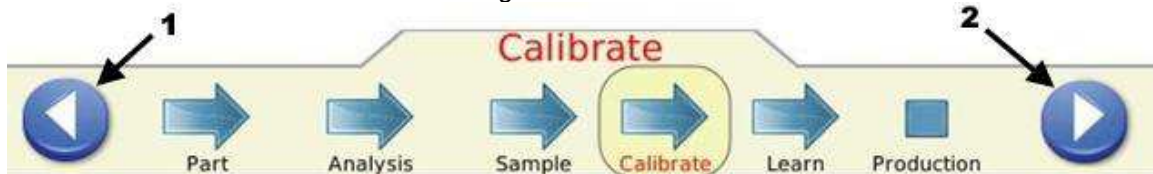

- 1 Previous task
- 2 Next task



NOTE
When there are multiple users and the Admin is logged in, the Task bar will become red/pink to indicate that Admin is the currently logged in user.

2.8 Definitions

2.8.1 Headroom (and how it affects crimps)

The Crimp Quality Monitor II monitors the forces that occur during the crimping process. The forces are the result of forming the crimp profile of the terminal and the compression of the wire strands within the terminal. Headroom is the difference between the peak force of a complete crimp and an empty crimp.

- A complete crimp is defined as a crimp at nominal crimp height, with both the insulation and the wire barrel properly filled with the wire.
- An empty crimp consists of only the insulated wire crimped in the insulation barrel of the terminal.

Headroom is specified as a percentage. Studies have shown that Crimp Quality Monitors have a better detection capability when the headroom is greater than 35%.

- Crimped terminals that use a small wire (in some cases, the smallest allowed by the manufacturer) rarely meet this 35% minimum requirement. In this case, a Crimp Quality Monitor II might not be very effective at detecting minor crimping defects.
- A crimped terminal with a larger specified wire is more likely to exceed this 35% minimum requirement, allowing the Crimp Quality Monitor to perform better and detect more crimping defects.

The quick headroom check described in section 0 provides a better understanding of how successful Crimp Quality Monitoring will be with the wire and terminal combination you are using.

2.8.2 Crimp Height

The crimp height is the measured height of the terminal on the wire. The CQM II uses a patented method to analyze data from the precision sensors and calculate the crimp height of the terminal.

- The maximum value for a good crimp is the nominal plus the tolerance.
- The minimum value for a good crimp is the nominal minus the tolerance.

2.8.3 Work index

The work index is a dimensionless value that indicates the relative position of a specified section of the crimp curve while the wire and terminal combination is being compressed.

Values from “Learn” crimps that are “Accepted as good” are collected to create a work index history. This is used to calculate a mean value and standard deviation. These values are then used to establish a range of good work index values.

Work index is a process monitoring analysis method. Analysis of its history can reveal how the crimping process changes over time.

2.8.4 Peak force

The peak force is a maximum force reading (minus the idle force reading) that occurs during the crimp. It is a relative and dimensionless value.

Values from “Learn” crimps that are “Accepted as good” are collected to create a peak force history. This is used to calculate a mean value and standard deviation. These values are used to establish a range of good peak force values.

Peak Force is a process monitoring analysis method. Analysis of its history can reveal how the crimping process changes over time.

2.8.5 Point-to-point (P2P) analysis

A series of points are established along the crimp curve in the P2P analysis. During the “Learn” process the CQM II computes means and standard deviations for each point and updates the mean and standard deviation for each point with every good crimp within an acceptable update range. During Production each point is compared to its upper and lower control limits, and if no points are out of their limits the analysis method considers the crimp to be a PASS crimp. A sensitivity value determines the amount of standard deviations allowed at each point. There is also a Fixed Upper and Lower control limits that get established by the first 30 PASS Crimps. Each point is checked both the fixed and non-fixed upper and lower control limits to determine if the crimp is good.

2.8.6 Fast Fourier transform (FFT) analysis

The FFT analysis method converts the force profile into its component frequencies. It computes mean and standard deviation for each of the lowest 32 frequencies from the Learn crimps and updates the mean and standard deviation with each good crimp. The FFT display tab shows a graph of the tolerance limits and the previous crimp’s computed frequency amplitudes. The tolerance limits are determined by the sensitivity selected by the user (default is 2.0) multiplied by the computed standard deviations for each frequency.

- If more than five frequencies fall outside the tolerance limits, the crimp status is FAIL.
- Otherwise, the crimp status is PASS.

2.8.7 Force Only Mode

In certain custom machine applications, the CQM II can operate with a force sensor only and no position sensor. A trigger sensor is used to signal the crimp event. In this mode of operation, only the Peak Force and FFT analysis methods are available. For the FFT analysis, additional parameters can be selected in the Learn mode (see section 0)

3 Receiving, inspection, and installation

3.1 Receiving and inspecting

The CQM II is thoroughly inspected during and after assembly. A final series of inspections is made before packaging and shipping to insure the proper functioning of the CQM II. However, damage can occur during shipment. When you receive the CQM II, complete the following steps:

1. Remove the outer bands from the box.
2. Carefully remove the CQM II from the box.
3. Inspect the CQM II for damage.
4. If damage is evident, file a claim against the carrier and notify TE immediately.

**NOTE**

Save the shipping carton and the entire documentation package shipped with the CQM II.

3.2 Installation

1. Install the power supply.
2. Plug the cord into the module.
3. Plug the AC plug into an appropriate supply.
4. Turn the power on.

The power indicator light on the front of the CQM II host module and CQM DAQ module illuminates. During the system boot process, several TE images are displayed. After approximately 30 seconds, the system is ready to accept a Work Order or displays a user login screen (depending on the user settings).

If the power indicator light is not illuminated or nothing is displayed, turn the power off and notify TE immediately.

**NOTE**

The installation instructions for the Crimp Quality Monitor II are included with the appropriate machine interface kit. For example, if the CQM II is being installed on a bench version of the AMP-O-ELECTRIC Model G Terminating Machine, the CQM/GTM Kit is required. The documentation package included with the kit contains the installation instructions for the system installation.

3.3 System settings

Touch the system settings icon to display the System Settings screen (Figure 6). This screen is used to set up the basic system configuration.

Figure 6: System settings

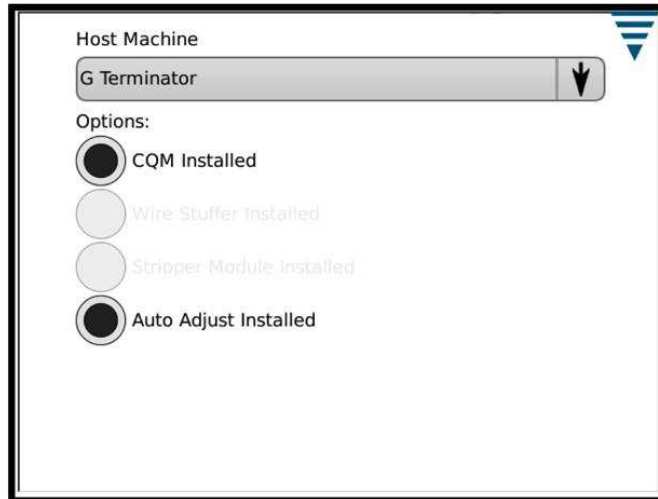

i **NOTE**
 The System Settings must be configured **by the CQM administrator** before any CQM settings are modified. Production cannot be run until configuration of the System Settings is complete.

i **NOTE**
 All other machine options must be installed before the System Settings are configured. Do not be confused with the CQM Installed option. In most configurations this should be selected as installed. Only the AMP 3K/5K (with stripper module installed) can be used without the CQM installed.

3.4 CQM settings

CQM Settings refers to the initial setup of the CQM II before production begins. This setup is performed by the CQM administrator. For system setup information, refer to section 6.

To access the CQM settings, touch the CQM Settings icon on the control panel screen (Figure 7).

Figure 7: CQM settings icon

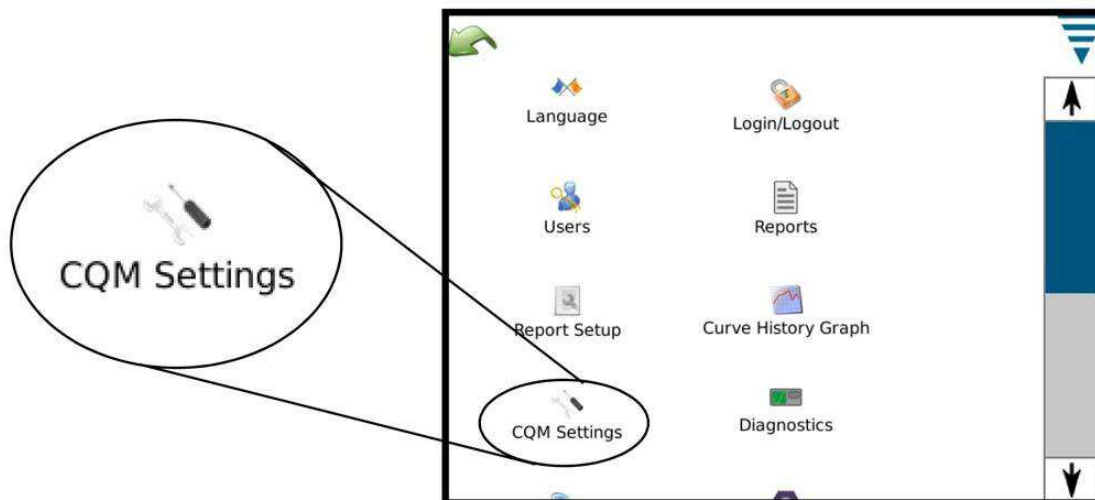

3.4.1 Setup Tab

Touch the CQM Settings icon to display the CQM Settings screen (Figure 8).

For the Custom selection, the four outputs can be configured to interface to the intended host machine, including the Crimp Enable output.

A non-terminated cable is provided for connection to the host machine. Refer to the installation documentation for specifics.

Figure 8: Setup tab

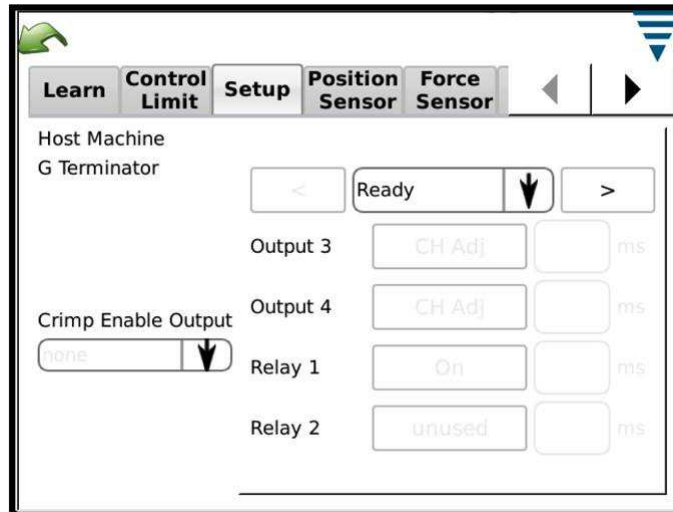

3.4.2 Position Sensor Tab

Touch the Position Sensor tab (Figure 9) to select the position sensor that is installed on your terminating machine. Table 6 lists the position sensors that you can select.

Figure 9: Position Sensor tab

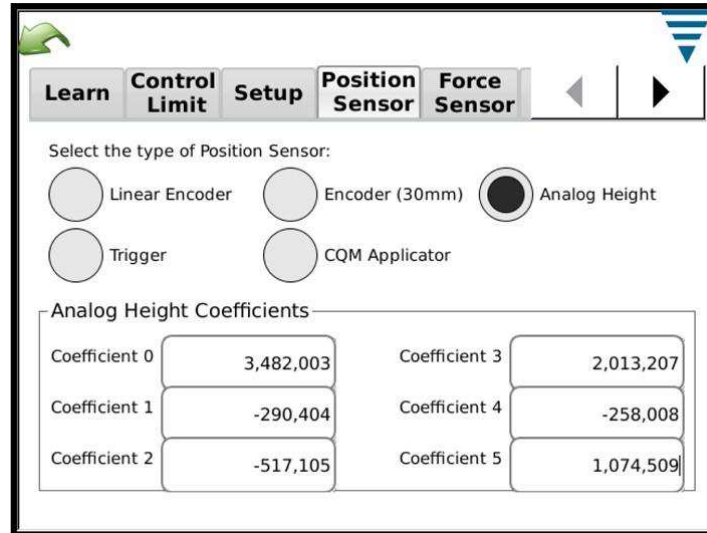

Table 6: Position sensors

| Sensor | Description |
|----------------|--|
| Linear Encoder | |
| Encoder | 30mm (for 30 mm stroke machines) |
| Analog Height | Original CQM position sensor |
| Trigger | For force only systems |
| CQM Applicator | For early TE applicators with CQM sensors integrated |

For the Analog Height sensor and TE applicators with CQM sensors, the six coefficients must be entered exactly as they are printed on the associated tag. An optional cable is required for connection.

For Force Only applications that use a trigger sensor (normally Custom host machine types), the CQM II does not use all of the available analysis methods. Only FFT and peak force are available

3.4.3 Force Sensor Tab

Touch the Force Sensor tab (Figure 10) to select the force sensor that is installed on the terminating machine. The options are **Piezo Frame** and **Strain Gauge** (base plate).

Figure 10: Force Sensor tab

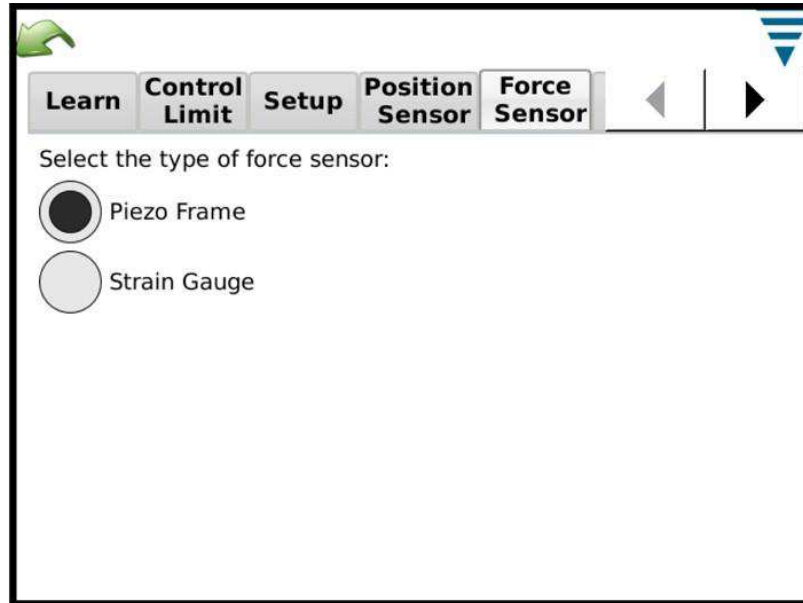

3.4.4 Sensor Calibration Tab

If you have the Analog Height sensor, then you must calibrate it. Touch the Sensor Calibration tab (Figure 11), follow the instructions on the display, and enter the low and high voltages that you measured based on the switch settings of the A/D Calibration Switch. A TE A/D Calibration Switch and a digital voltmeter are required to perform this calibration.

Figure 11: Sensor Calibration Tab

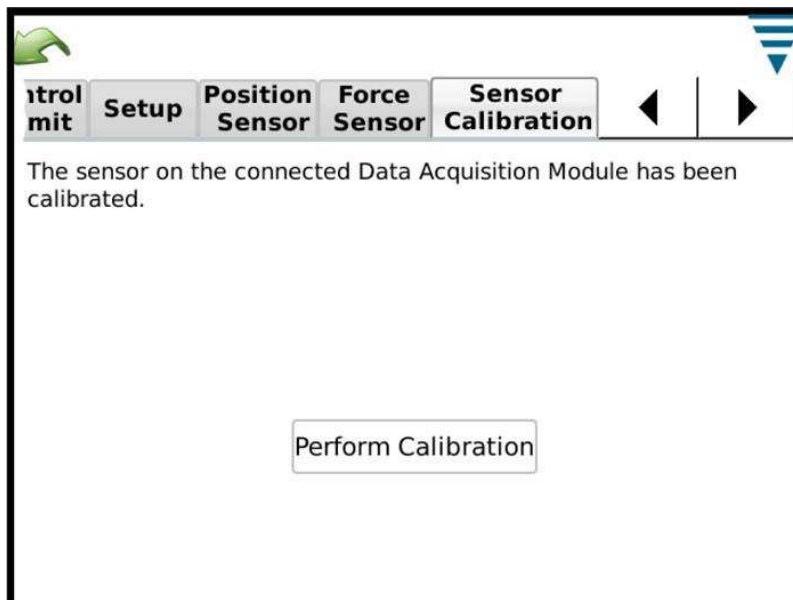

3.4.5 Learn Tab

Touch the Learn tab (Figure 12) to configure the Learn settings. Start with the default setting of 5 crimps while you are gaining experience with the process. You can lower it to 3 crimps when you are confident in your process and the terminals you are using. After you enter production, increase the number of Learn crimps to improve the statistical analysis of the crimp process.

Figure 12: Learn Tab

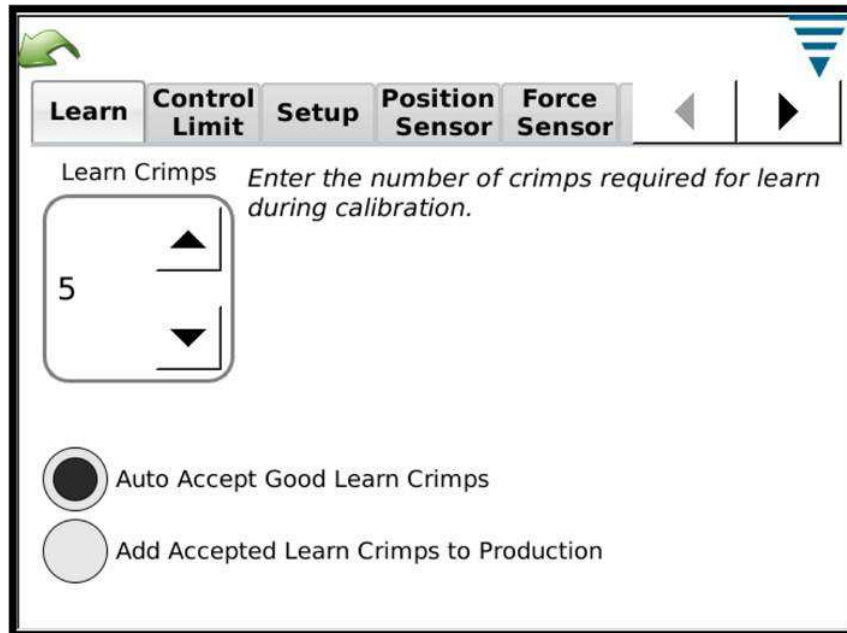

Auto Accept Good Learn Crimps: All learned crimps are automatically Accepted as Good. You do not have to acknowledge the CQM II after every learned crimp.

Add Accepted Learn Crimps to Production: Each Accepted Learn crimp is counted in the total and batch counts.

During the Learning process, you must evaluate each crimp and ensure that it meets your acceptance criteria. The CQM II starts fully analyzing crimps when it is in Production Mode.

If Crimp Height Monitoring is enabled, Crimp Height is evaluated during each Learn crimp. When a crimp falls outside of the tolerance, you are notified and that crimp is not used for learning.

3.4.6 Control Limit Tab

Touch the Control Limit tab (Figure 13) to set the control count.

Perform Control Limit Checks: If you select this option, a control count error message is displayed when the number of consecutive control limits is equal to the Control Count.

Figure 13: Control Limit Tab

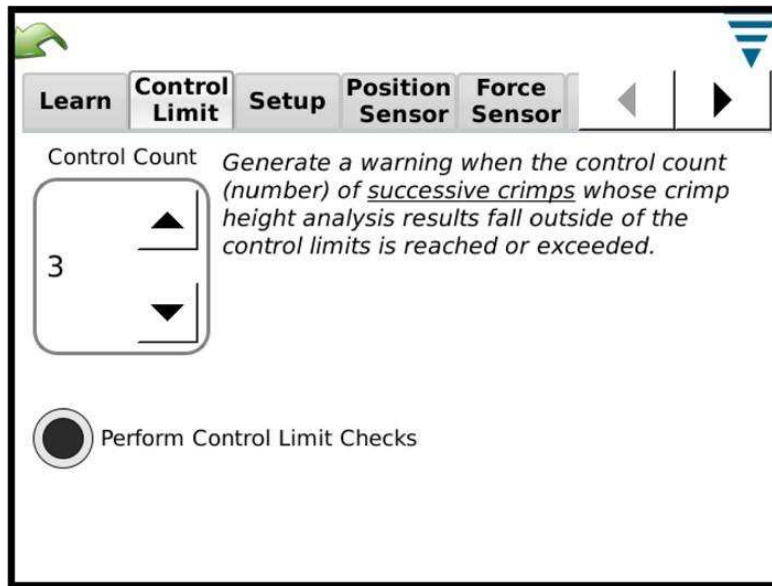

3.4.7 Graphing Tab

Touch the Graphing tab (Figure 14) to select the number of crimp history points to display on the Basic production screen.

Figure 14: Graphing Tab

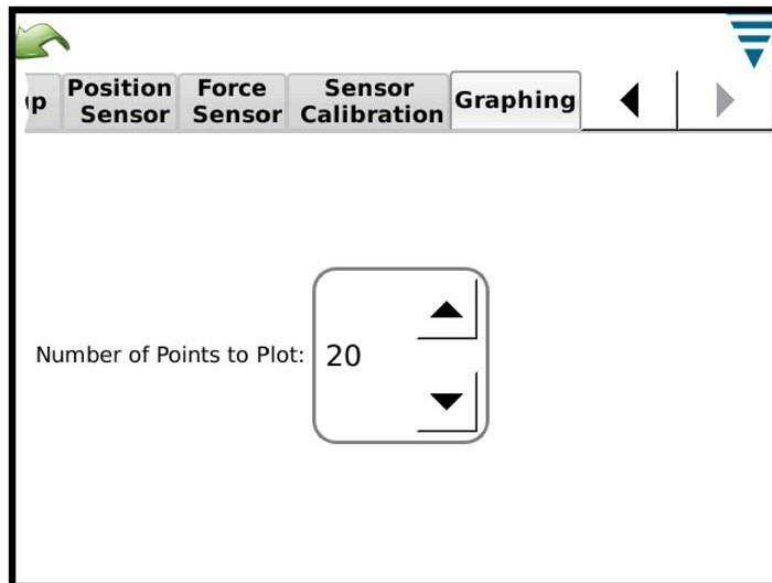

4 Production run setup

4.1 Options

This is the first screen in the task bar. It is displayed when you touch the home icon on the menu bar. To use the options, select the corresponding radio button.

Figure 15: Options

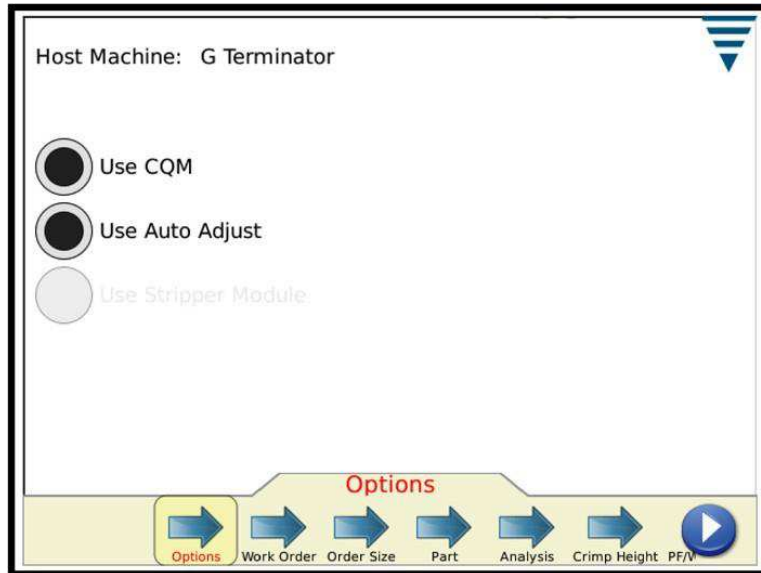

4.2 Work Order

Using a Work Order is optional list, provide additional detail in printed and saved Reports that the CQM II can provide. To use a Work Order, select the **Specify a Work Order** radio button. You can select an Existing Work Order from the list or create a new work order.

Touch the Work Order label or the Edit icon.

Figure 16: Work Order

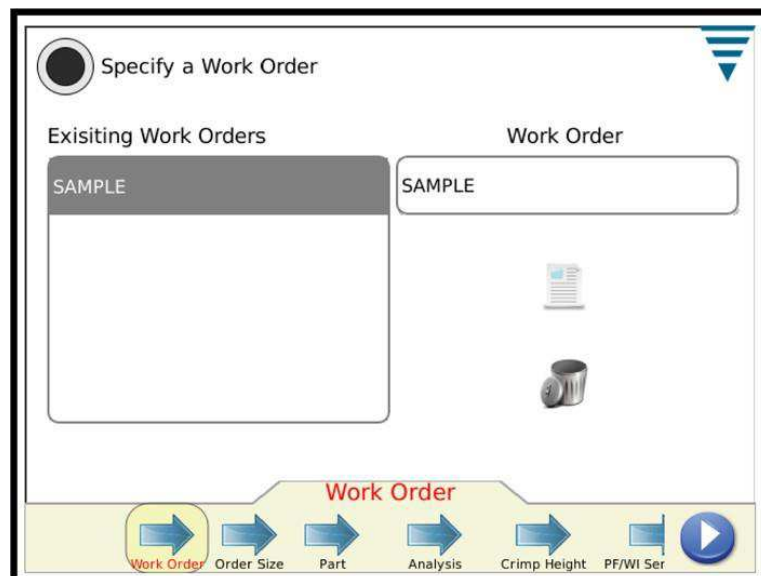

4.3 Order Size

To use the Order Size counters, select the **Specify Total and Batch Sizes** radio button. Touch each field (**Total Size** and **Batch Size**) to enter a value.

Figure 17: Order Size

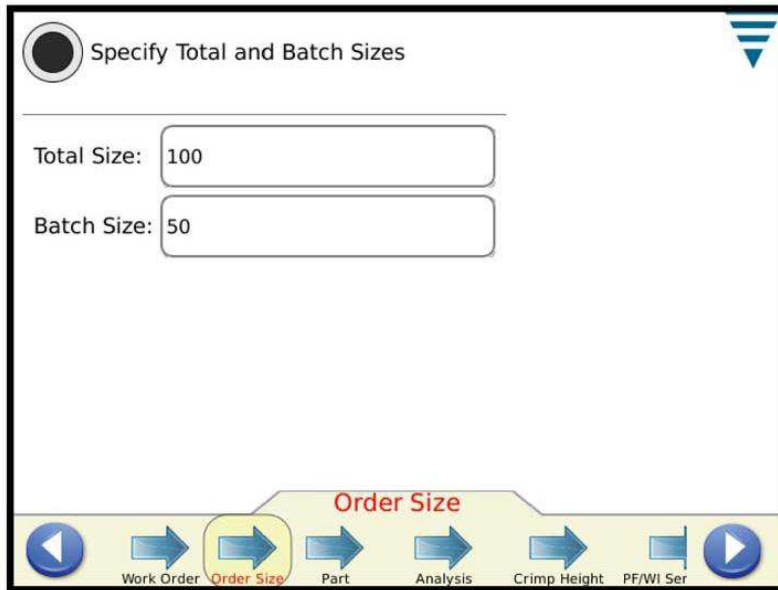

4.4 Part

You must select a part number. The part number determines the analysis method selections and associated parameters for the product that you want to produce.

Select an Existing Part Number from the list or create a new part number. To delete a part number, select it from the list and touch the delete icon.

Touch the **Analysis** arrow (or the **Next task** button in the lower right corner) to move to the next task.

Figure 18: Part

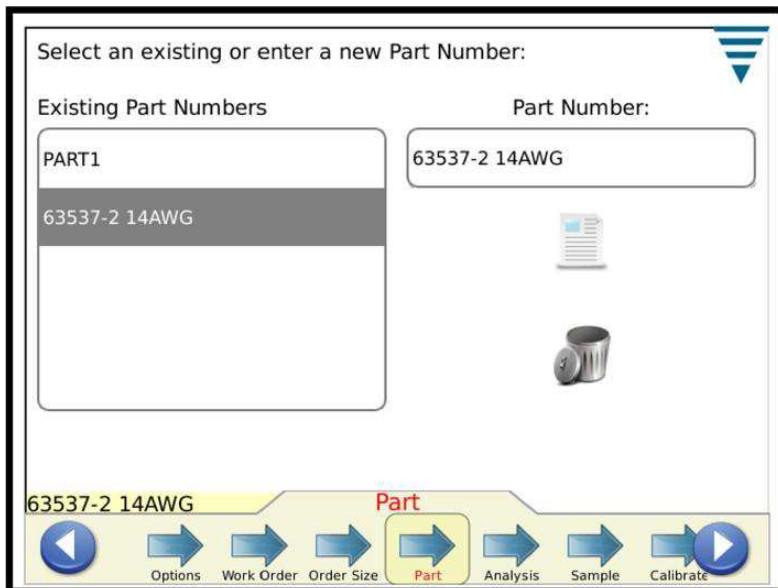

4.5 Analysis Methods

Once you touch the Analysis icon, you will notice that the number of selections in the task bar increase to provide more choices for editing parameters for the Analysis methods. First, start by choosing the analysis method(s) for the part. Available analysis methods are: Crimp Height (only on TE terminators), Peak Force, Work Index, Point to Point, and FFT (systems with just a force sensor can only use the Peak Force and FFT methods). The Default for a new part is all analysis methods selected.

Figure 19: Analysis Method

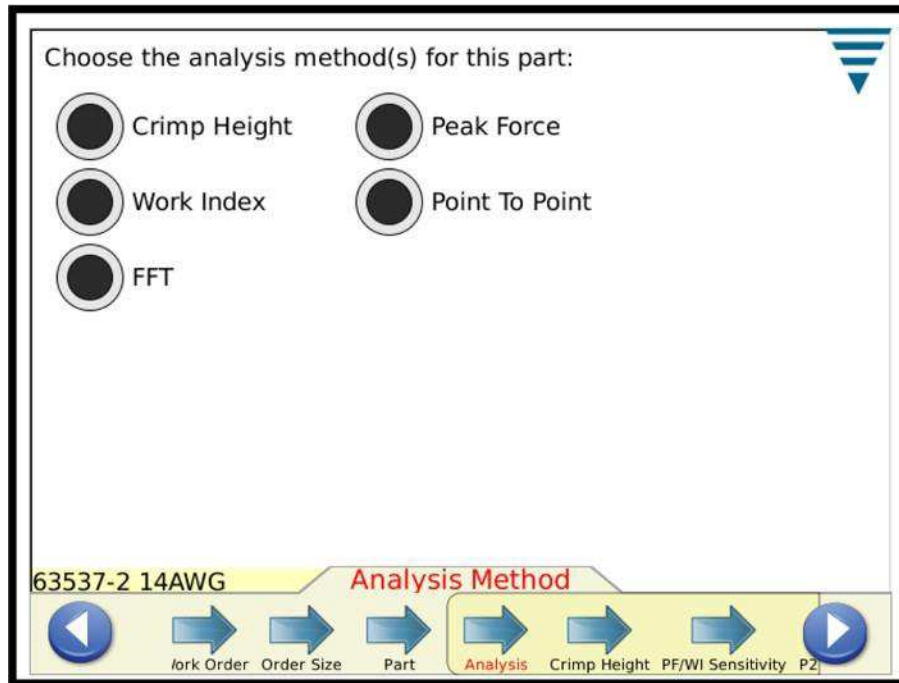

4.6 Crimp Height

If Crimp Height is selected, touch the Crimp Height arrow or the right arrow icon to move to the next task.

Enter the specific Crimp Height and Tolerance for the part by touching the appropriate box. For the entry of tolerance, if the tolerance from the manufacturer is +/- 0.002" inches enter 0.002" inches

Select the Update Control Limit radio button to turn on the feature that tells the monitor to automatically calculate a control limit for the part during production. The Default Control Limit initializes to 0.0015 inches and will automatically change once 30 production crimps have occurred.

The user can specify their own control limit if they do not want to have one updated for them. The control limit is also important with the autoadjust feature on some G-terminators. When the average crimp height of three consecutive PASS crimps is outside the Control Limit the autoadjust motor on the G-terminator will make an adjustment to bring the crimp height back within the control limit range.

Figure 20: Crimp Height

Enter the Crimp Height analysis parameters for this part:

Crimp Height: 0.0750 in

Crimp Height Tolerance: 0.0020 in

Update Control Limit

Control Limit: 0.0015 in

63537-2 14AWG

Crimp Height

Order Size Part Analysis Crimp Height PF/WI Sensitivity P2P/FFT Sensitivity

Touch the next Sensitivity arrow or the right arrow icon to move to the next task.

4.7 Peak Force (PF) and Work Index (WI) Sensitivity

Touch the Up and Down arrows to change the sensitivity settings of the Peak Force and Work Index. Press Default to return the setting to the factory default.

Default sensitivity settings typically work good for terminals and wire combinations that meet the minimum Head Room criteria of 35% or greater. If the CQM II Fails crimps that you determine to be Good crimps, then you may want to adjust the sensitivity of the analysis method that is causing this problem. In this case, adjust the sensitivity to be less sensitive by a few points, for example 3.0 to 3.5 (the higher the number the less sensitive).

If the CQM II is not detecting the crimp failures that you expect it to detect, then you may want to adjust the sensitivity of the various analysis methods to be more sensitive by a few points, for example from 3.0 to 2.5.

Touch the next Sensitivity arrow or the right arrow icon to move to the next task.

Figure 21: PF/WI Sensitivity

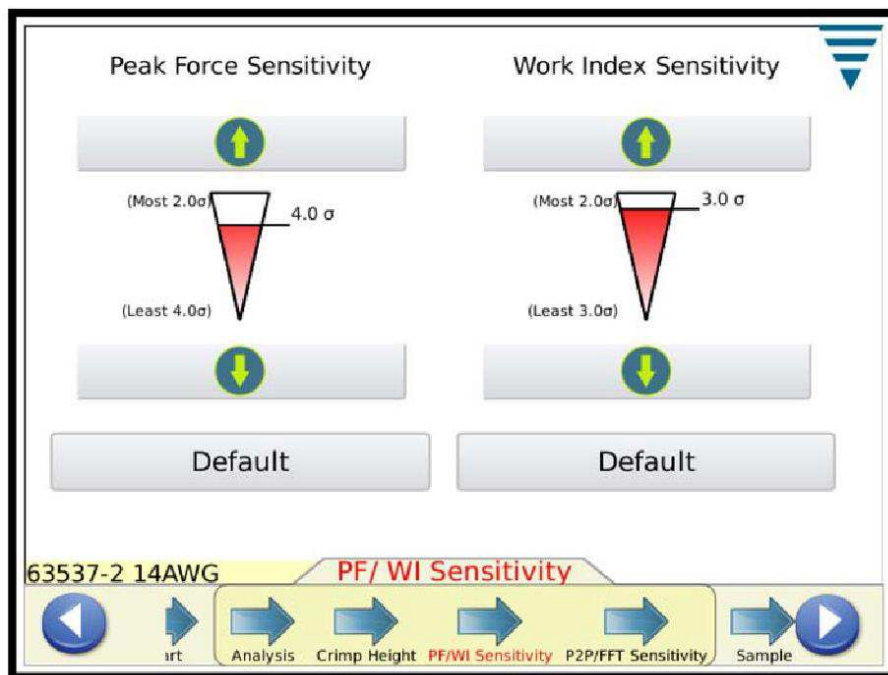

4.8 Point to Point (P2P) / FFT Sensitivity

Touch the Up and Down arrows to change the sensitivity settings of the Point to Point and FFT. Press Default to return the setting to the factory default. Adjusting the sensitivity to eliminate problems or to enhance performance for these analysis methods is similar to the prior description for Peak Force and Work Index.

Touch the Sample arrow or the right arrow icon to move to the next task.

Figure 22: P2P/FFT Sensitivity

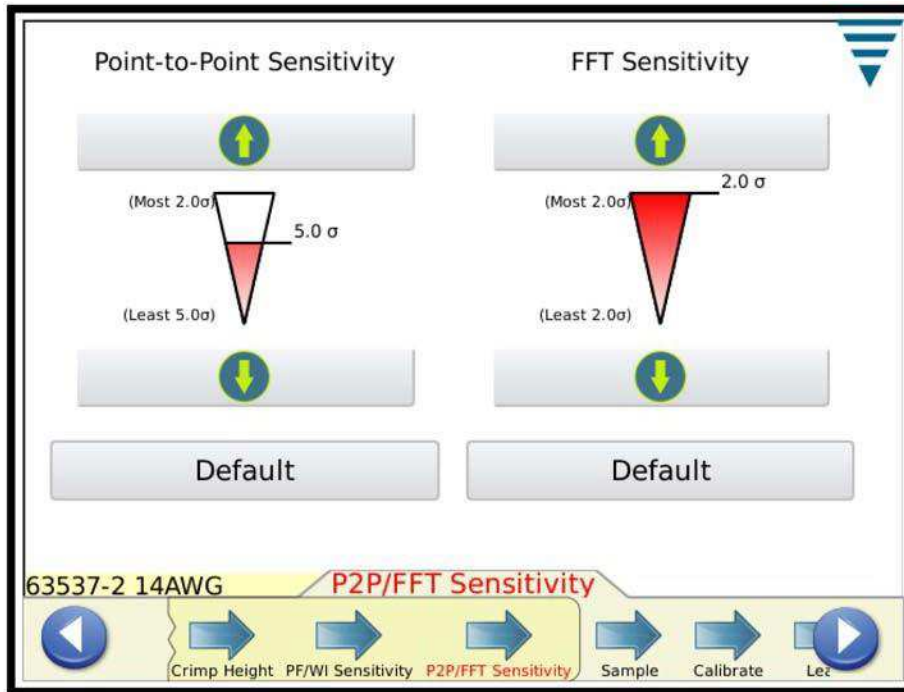

4.9 Sample

Use the Sample mode to make sample crimps to setup the process. In this task you will install the applicator, load product, and run your initial crimps to set terminal feed and crimp height. The CQM II will graph a crimp curve (provided the force is sufficient) but will not be analyzing the crimp. The graph is only for reference purposes. If the CQM II is connected to a G-terminator that has a crimp height auto-adjust motor, the Sample screen will provide buttons to touch to increase or decrease the crimp height. Touch the Calculate Head Room button if you want to perform a quick check of your wire and terminal to see how good the Head Room will be. Refer to Paragraph 2.8 for an explanation of Head Room.

Basically, once you have the system properly set up with the correct crimp height, to perform a Quick Headroom Check, produce a good crimp with a stripped wire, and then produce a crimp that only has insulation (non- stripped) in the insulation crimp). If this part has not been calibrated before you may need to produce a Gain crimp.

After you are satisfied that the quality of the crimp meets your requirements, you can move on to calibrate the crimp.

Touch the Calibrate arrow or the right arrow icon to move to the next task.

Figure 23: Sample

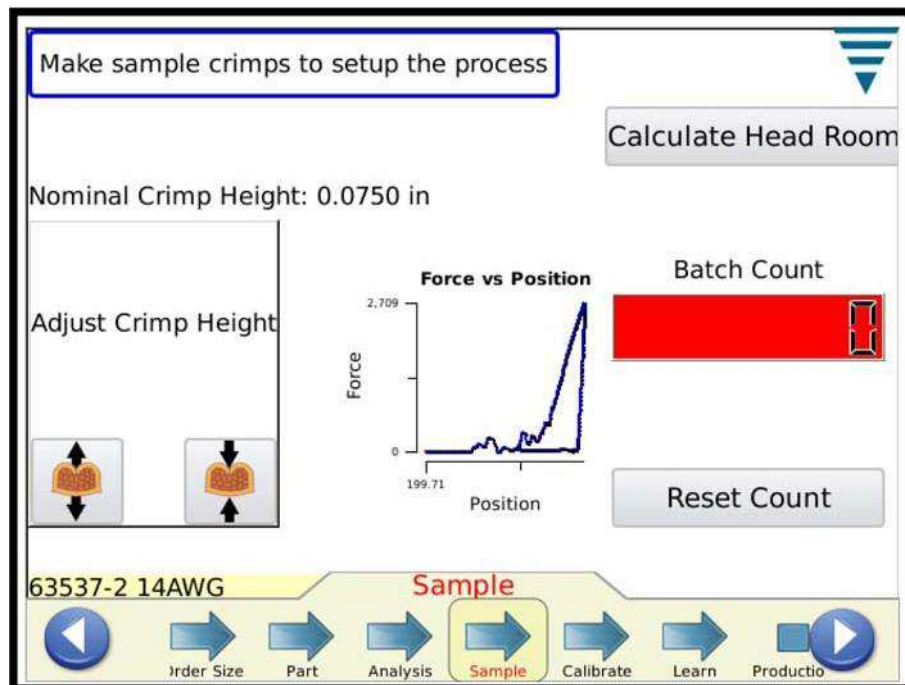

4.10 Calibrate

If the system uses the Piezo Frame sensor, the first step in the Calibrate task is to perform a crimp so the CQM II can set the amplifier gain. Carefully inspect the crimp to ensure its quality. If the Crimp is not to your quality requirements, then you can Reset the gain and try again.

Figure 24: Calibrate

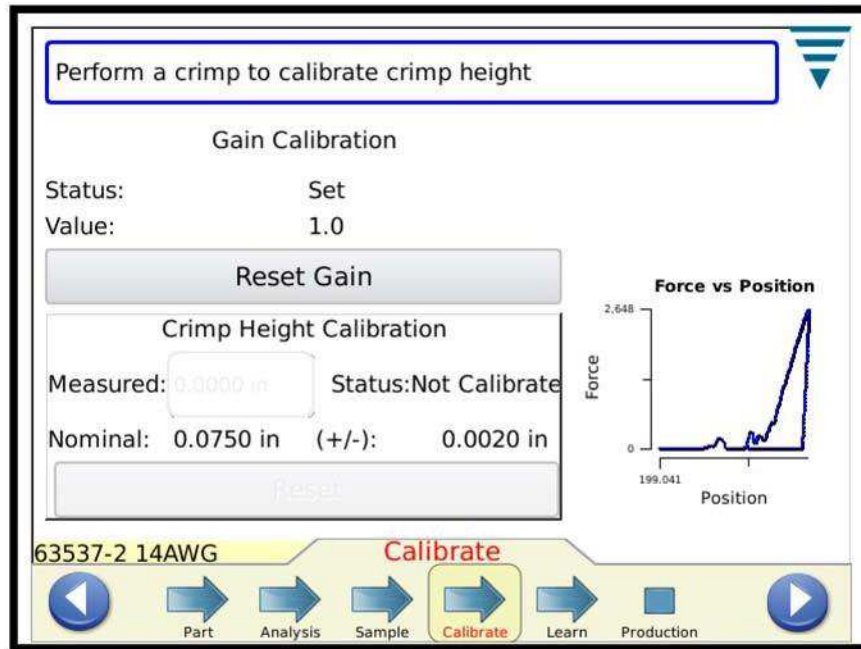

4.11 Learn

To learn the process, proceed with crimping the number of terminals required for Learn (as entered in the CQM Settings). Carefully inspect each crimp to ensure its quality. If the Crimp is not to your quality requirements, then you can Reject the crimp and do it again. If Crimp Height analysis is selected, a Crimp Height will be calculated for each crimp and displayed. The Learn screen also shows the Learn Count, Last Crimp Status, and a crimp curve for your reference.

Touching the graph screen will bring up the full size graph screen. If using FFT, analysis buttons are provided for adjusting a threshold level for FFT Analysis and to select a speed compensation for terminators that may have variable cycle rates due to incoming voltage variations, pneumatic variations, or load problems. It is recommended that you first switch to the Force Vs Time graph before making adjustment. After adjustments are made re-learning is required and learn counts will go back to 0.

Recommendations for Force Only installations with low headroom crimps (<35%).

1. Try No Speed Compensation and Threshold set to around 20%.
2. Try these settings and compare: Speed Compensation and Threshold set to around 20%.

Choose the one that works the best for your process.

With higher headroom crimps the threshold can be reduced or set to 0 (default is 0).

A line will be drawn on the crimp curve graph at the threshold level. Increase the threshold level if this line intersects a visibly noisy portion of the crimp curve.

Figure 25: Perform a crimp to learn

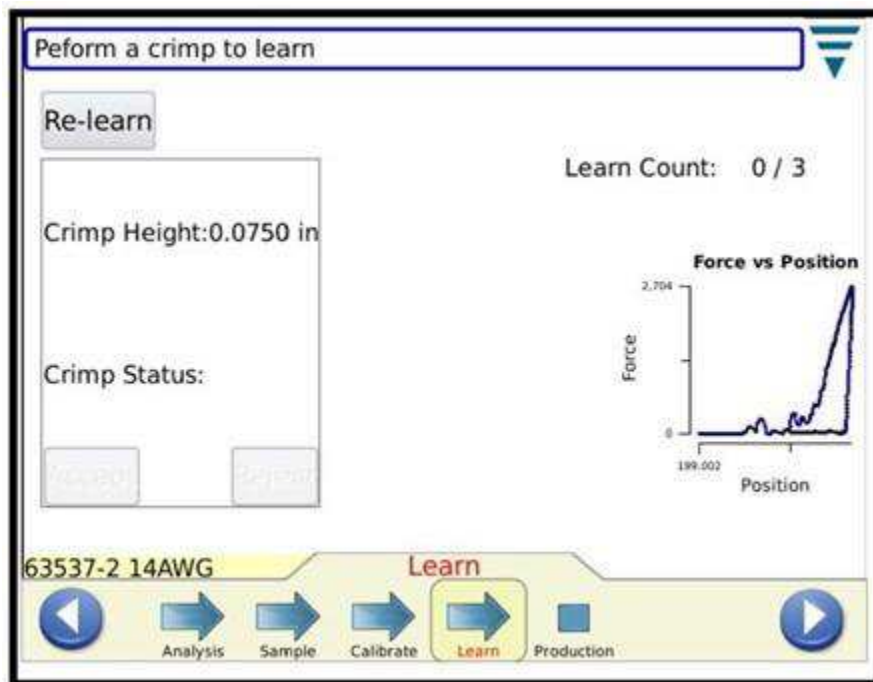
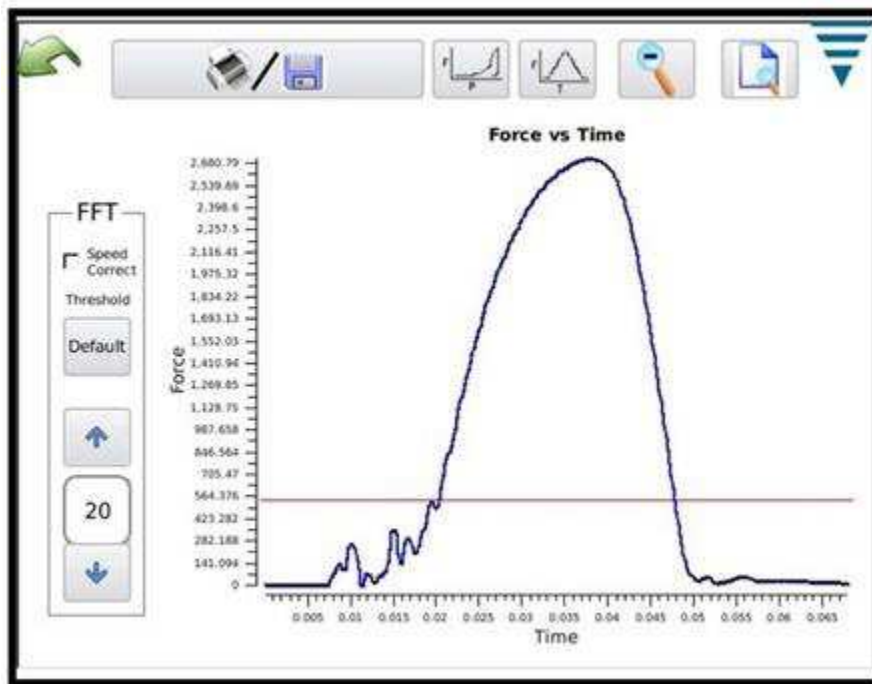

Figure 26: Crimp curve graph



Once you have completed all of the Learn crimps, the display will indicate Process Learned.

It is recommended to re-learn the process if something dramatically changes in the process such as changing to a new reel of terminals or a different type of wire. It is also advisable to Re-Learn if while in production you experience too many failures that with further inspection meet your quality requirements. Touch Re-Learn perform the Learn process again.

Figure 27: Process learned

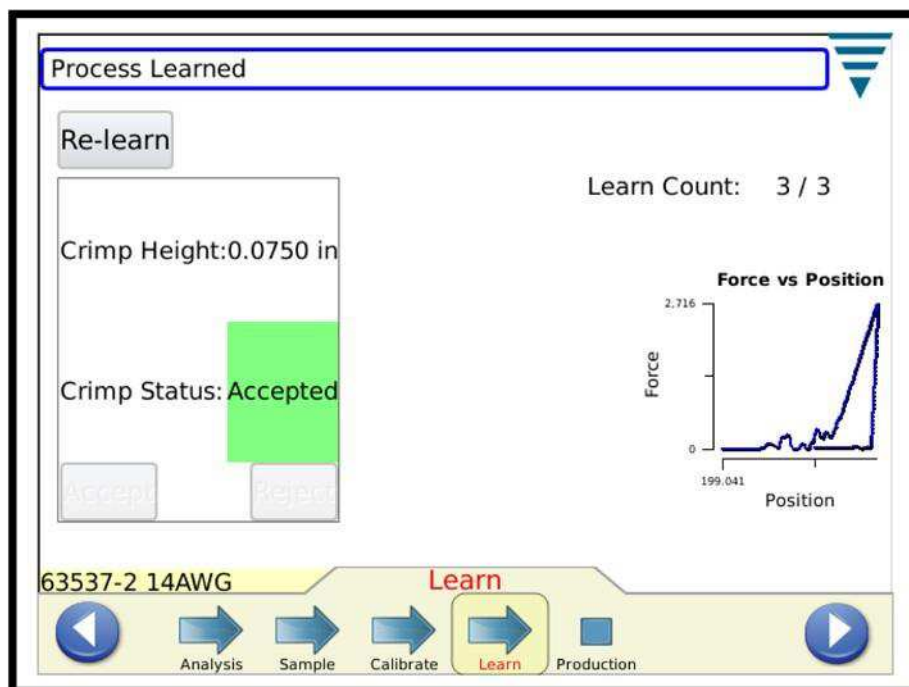

Based on settings that were made in CQM Settings, the Learn crimps may require the operator to touch Accept for each Crimp.

After the display indicates Process Learned, you can then proceed to Production. Touch the Production icon or the right arrow icon to move to the next task.

**NOTE**

The Crimp Quality Monitor II is a PROCESS monitor. It is influenced by many variables that include changes in wire, terminal, applicator, terminal condition, operator, environment, etc. Changes in any of these variables, will affect the process and the process will have to be re-learned.

5 Production

**NOTE**

Operation without CQM Analysis - if the user wishes to operate the terminator without doing any CQM Analysis, the user should make sure that a part is selected and then go to the sample screen to do any crimping that they do not want analyzed. See section 4.9 Sample.

The production screens show the Work Order name, Part name, Total and Batch counters, and the overall status of the last crimp. Selecting from the seven tabs provides differing results, graphics, and history for your use. The number of tabs available is based on the analysis methods selected. Touching the Total and Batch count box at the top of the screen will prepare a report showing the statistics for the production run and specifics for the selected process analysis methods. This report is a pdf that can be printed or saved. Also on this screen is a Reset Count button that when touched, resets the Total count, Batch count, and all statistic data relevant to the work order. The crimp process is still calibrated and learned when the counts are reset.

If the crimp has passed ALL of the selected analysis methods, the word "PASS" will be highlighted in green. See below.

A crimp curve is displayed.

Touching either of the graphs will zoom on the graphs.

If the crimp fails any of the selected analysis methods, the word "Fail" is highlighted in red (see Figure 29 on page 34).

5.1 Basic Screen

The basic screen (Figure 28 and Figure 29) provides a visual indication of the Crimp Status History for selected analysis methods. For each analysis method, the results are shown as: Green for a good crimp, red for a failed crimp, Orange for a Control Limit (not a failure but an indication that the Crimp Height is getting close to the tolerance), and white for a crimp that was not analyzed by that method. For example, the learn crimps for analysis methods will show white with the exception of the Crimp Height that should be green for those Learn crimps. The basic screen also shows the last crimp curve as either Force vs. Time or Force vs. Displacement. Touching the crimp curve makes it full screen where you can toggle between the two different curves. The Basic screen is one of the more common screens to display while in production. Refer to the two previous screens.

Figure 28: Basic (pass)

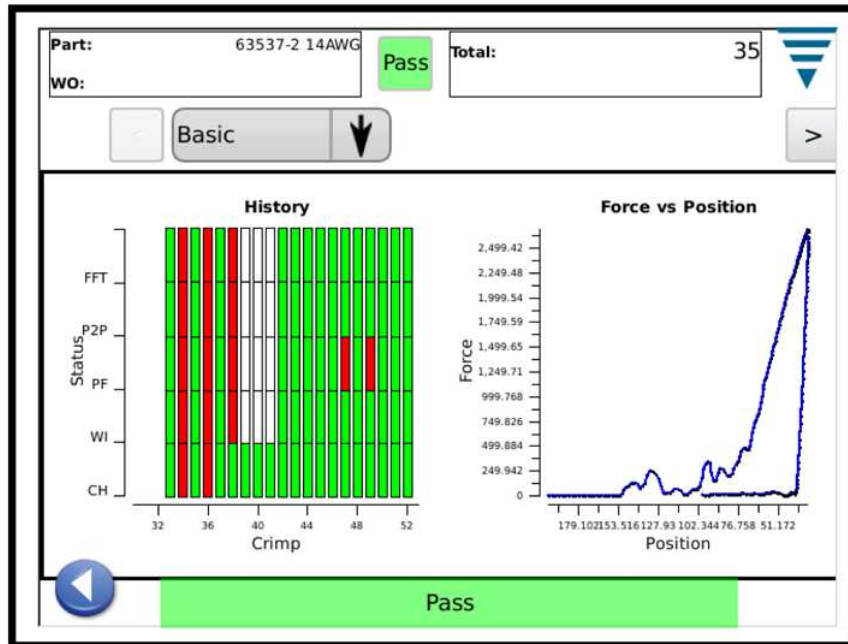
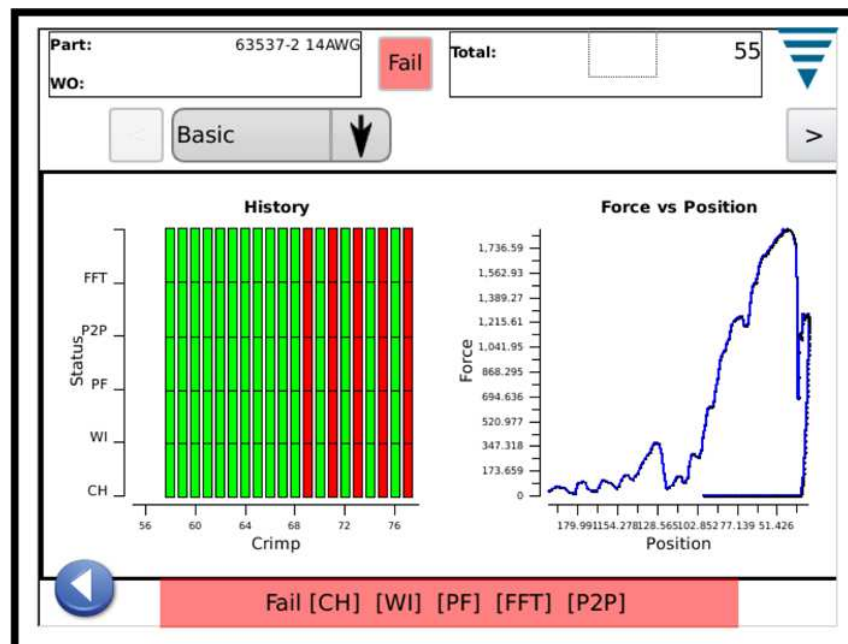

Figure 29: Basic (fail)



5.2 Status

The status screen provides individual status indicators for each selected analysis method as well as data that is relevant to the analysis method. If any one analysis method fails, the overall status of the crimp is a Fail. The colors of the indicators are as previously described in the Crimp Status History on the Basic screen.

Like the Basic screen, this Status screen is one of the more common screens to display while in production.

Figure 30: Status (pass)



Figure 31: Status (fail)

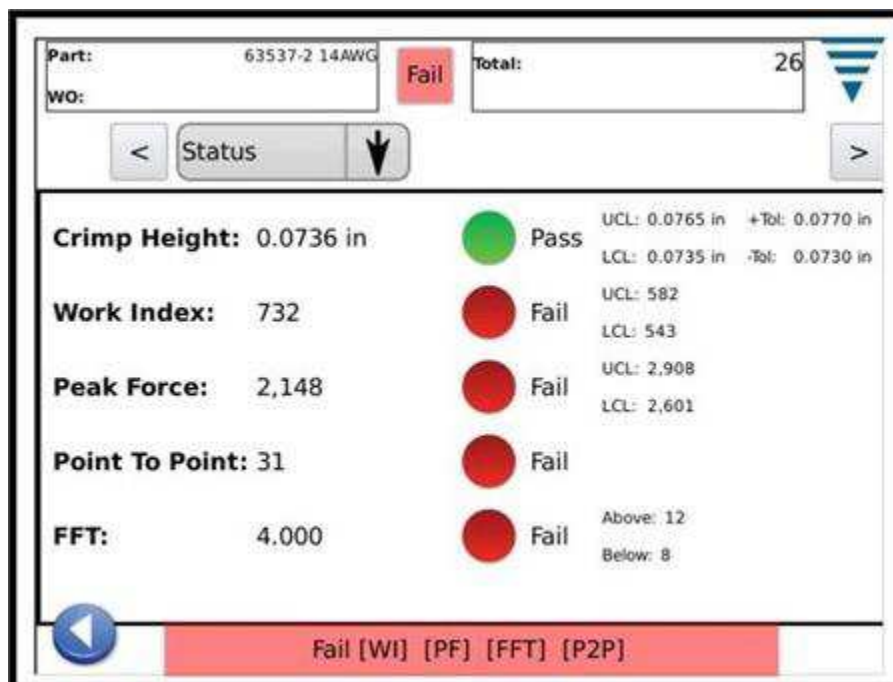

5.3 Crimp Height

The Crimp Height screen provides a crimp history graph showing the tolerance limits and the calculated crimp height for each crimp. To see more points than those shown, simply touch the graph to enter a full screen mode and use the arrow keys to move forward and backward in time.

The other graph is a histogram of the Crimp Height Distribution for the entire work order. This screen is useful to observe the process with regards to the Crimp Height.

Figure 32: Crimp height

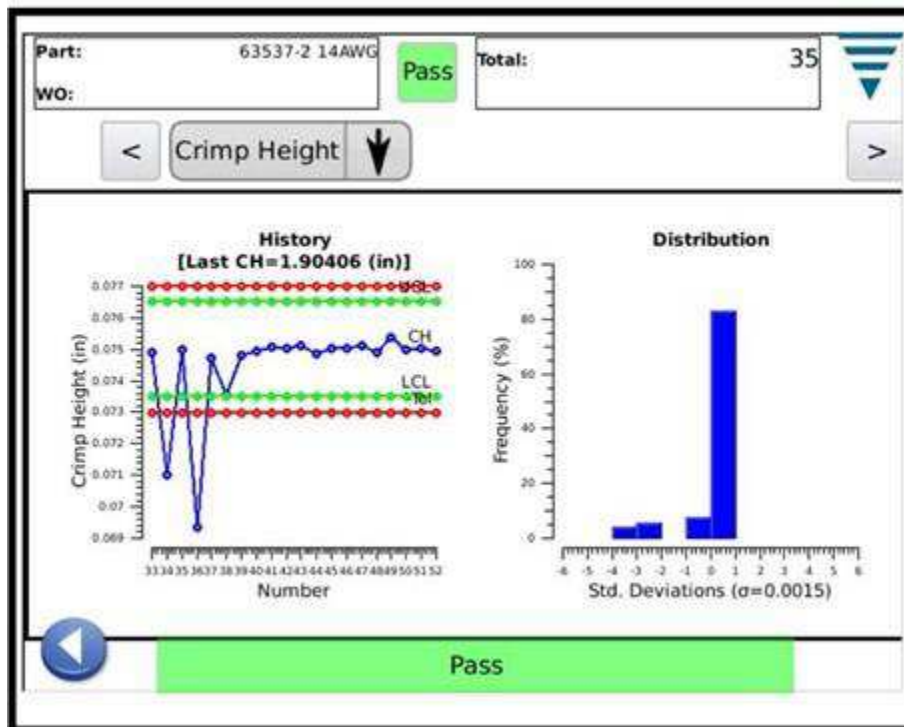

5.4 Work Index

The Work Index screen provides a crimp history graph showing the tolerance limits and the calculated work index calculated for each crimp. To see more points than those shown, simply touch the graph to enter a full screen mode and use the arrow keys to move forward and backward in time.

The other graph is a histogram of the Work Index Distribution for the entire work order. This screen is useful to observe the process with regards to the calculated Work Index.

Figure 33: Work index

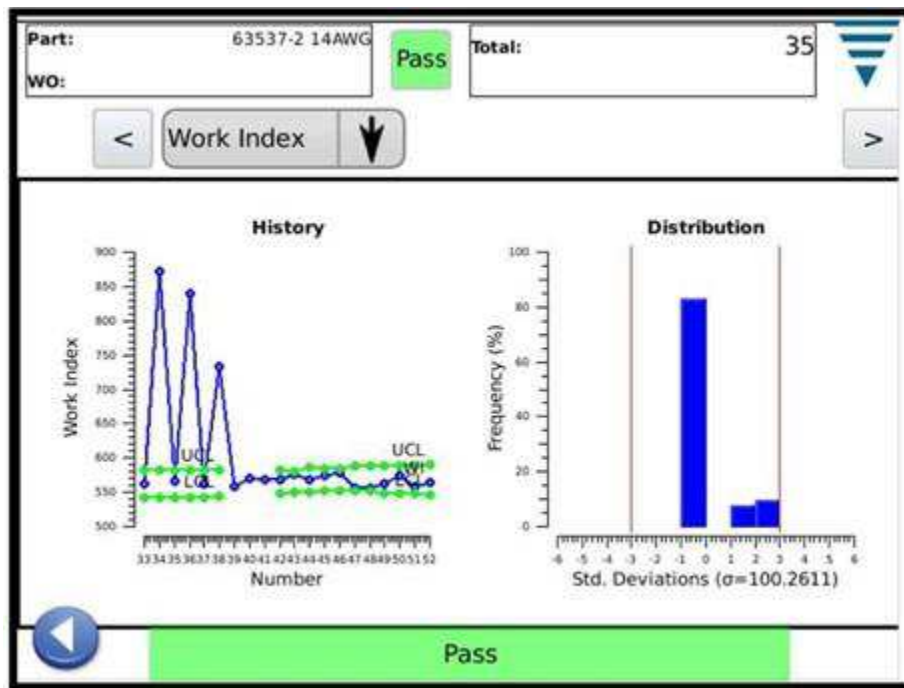

5.5 Peak Force

The Peak Force screen provides a crimp history graph showing the tolerance limits and the peak force recorded for each crimp. To see more points than those shown, simply touch the graph to enter a full screen mode and use the arrow keys to move forward and backward in time.

The other graph is a histogram of the Peak Force Distribution for the entire work order. This screen is useful to observe the process with regards to Peak Force.

Figure 34: Peak force

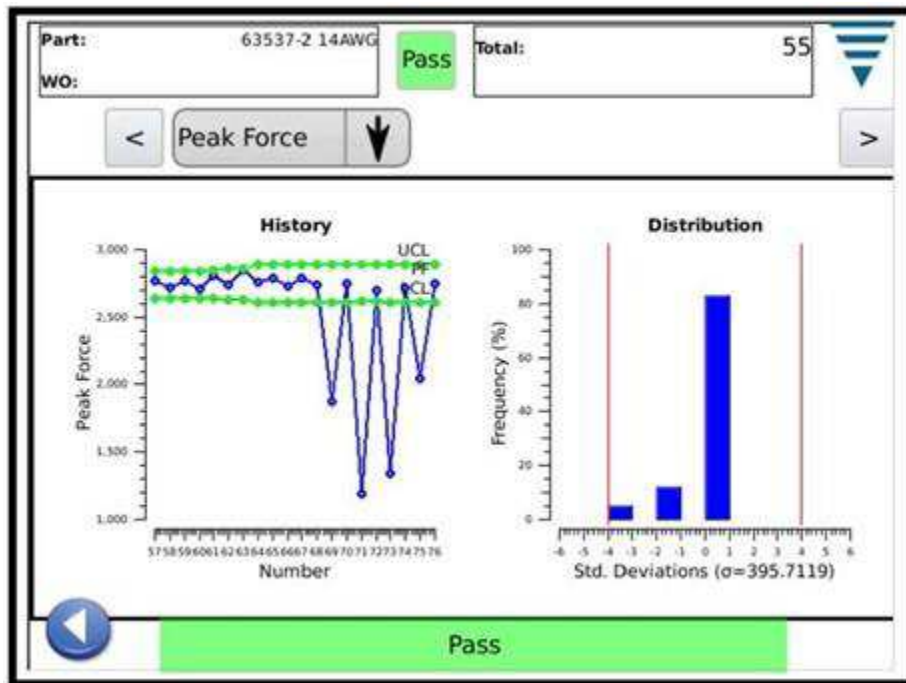

5.6 P2P

The Point-to-Point (P2P) graph on this screen shows the 50 points of the last crimp that are individually analyzed to ensure a good crimp. If any point is outside the tolerance band, then the result of the analysis is a Failure. P2P is a signature analysis method so there is no history other than Good or Failed. This graph only shows the 50 points.

This screen is useful to observe the analysis of the 50 points used in P2P.

Figure 35: P2P

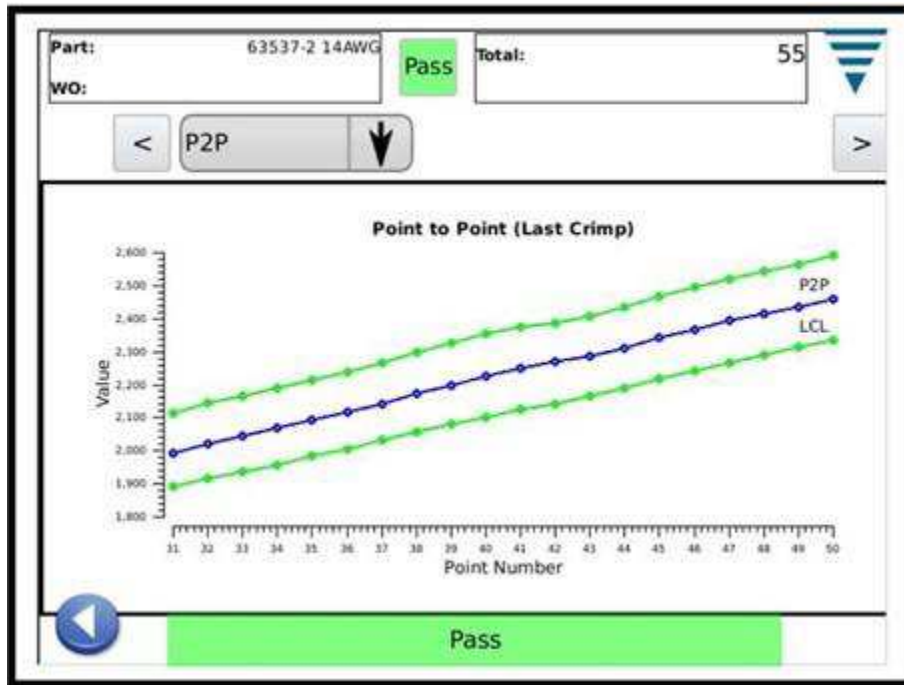

5.7 FFT

The Fast Fourier Transform (FFT) graph on this screen shows the component frequencies of the last crimp that are analyzed to ensure a good crimp. The FFT analysis requires five or more to be outside the calculated tolerance for a failure.

This screen is useful to observe the component frequencies used in FFT. There are a total of 32 component frequencies that are used in the FFT. Due to screen size, only a portion are shown on the screen. To view them all, touch the graph to expand it to full screen and then use the arrow buttons to see it all.

Figure 36: FFT

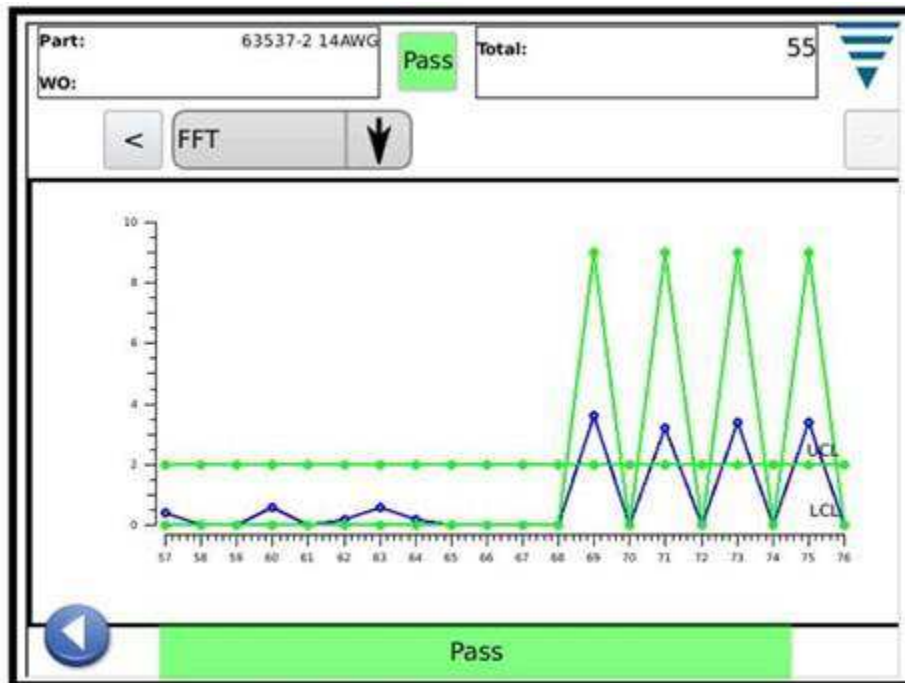

6 Control panel

Touching the Control Panel icon on the main menu screen brings up the control panel. The following control panel tools are to be used by the CQM administrator.

**NOTE**

For system settings, refer to section 3.3. For CQM II settings, refer to section 3.4.

Figure 37: Control panel

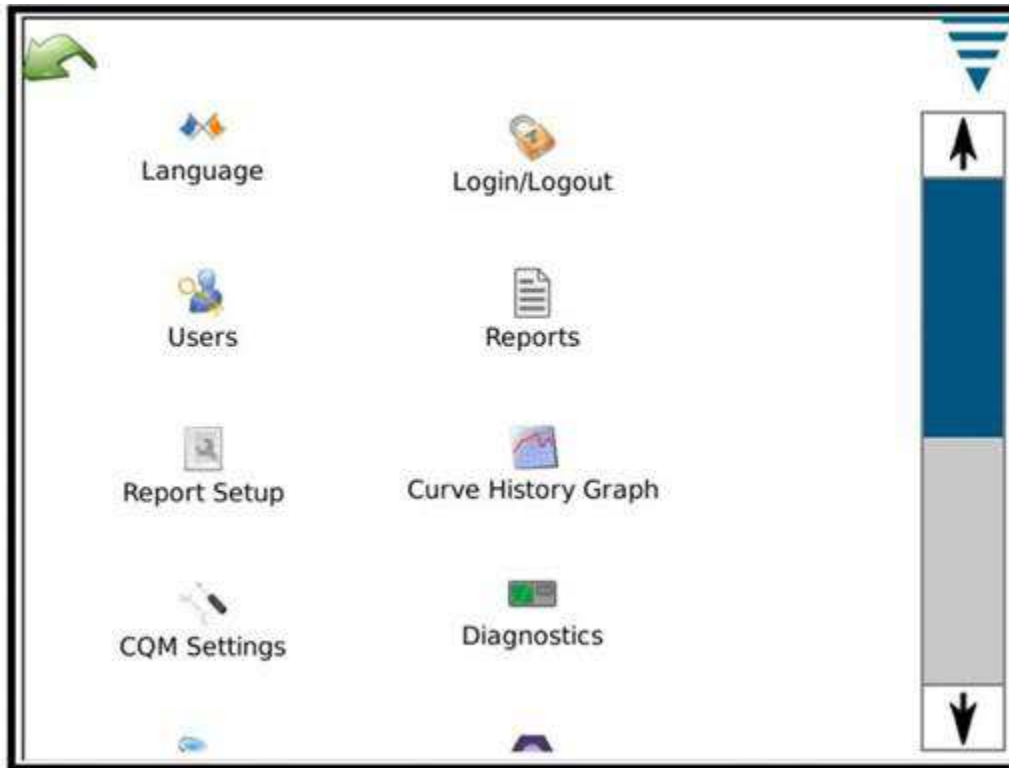

6.1 Language icon

To pick a language, touch the language icon, then select the appropriate language and save it.

Touch the icon to select the Language screen. Choose the language from the drop down list. If you want the selected language to be used when the unit powers ON, select the radio button Default Language when the language is selected.

6.2 Login/Logout

Touch the icon to select the Login/Logout screen. The user that is logged on will be displayed. Choose Logout to select a new user. Choose the new user from the drop down list and then enter the password for that user.

The initial system only has a single User, the Administrator. If no password is selected there is none needed to Login/Logout of the system. Once additional users are added or a password is entered for the Administrator, then a password will be required to Login/Logout of the system.

6.3 Users

6.3.1 Add New User

First enter the user name. Then enter the user password and then verify the password by entering it again. Choose Add User to finish

Figure 38: Adding a new user

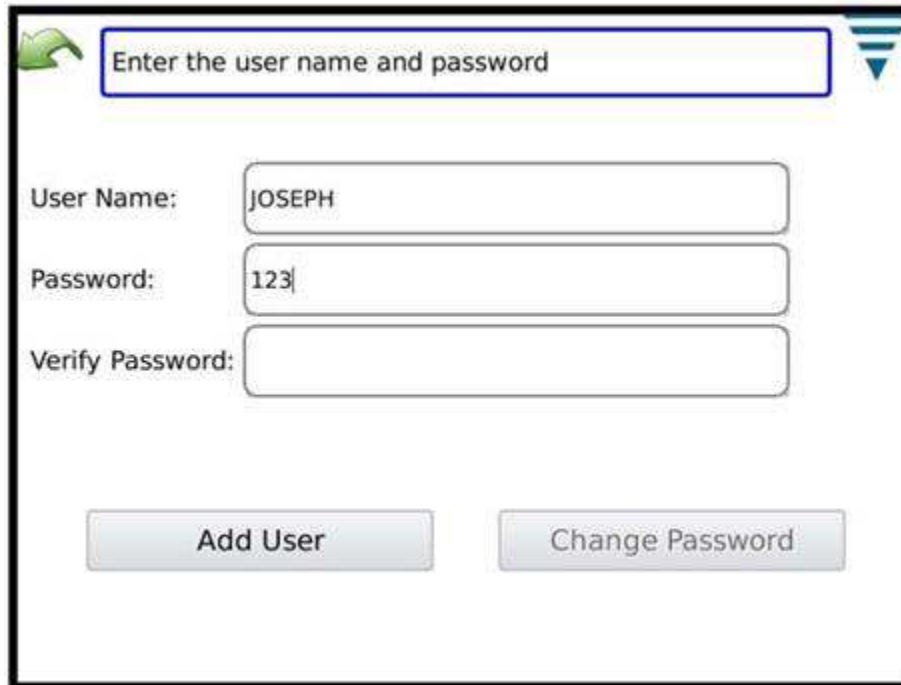

Enter the user name and password

User Name: JOSEPH

Password: 123

Verify Password:

Add User Change Password

6.3.2 Change Password

With the user selected from the drop down list, choose Change Password. The user must enter a new password and then verify the password by entering it again.

6.3.3 Delete

With the user selected from the drop down list, choose Delete.

6.3.4 Permission Settings

Permissions are a method to allow or not allow individual users access to certain tasks or actions that can be performed on the CQM II.

With the user selected from the drop down list, choose the appropriate radio button to provide the user permission for the various tasks and actions.

**NOTE**

The user that is logged on must have permission to make these modifications.

Figure 39: Permissions

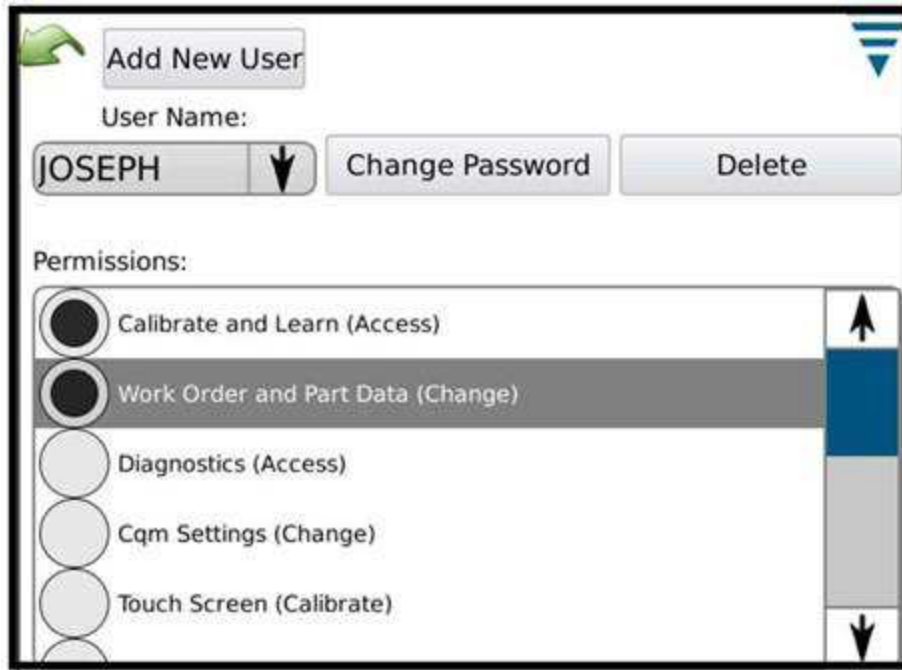

The screenshot shows a user management interface. At the top left is a green arrow icon and a button labeled "Add New User". Below this is a "User Name:" label followed by a dropdown menu showing "JOSEPH" with a downward arrow. To the right of the dropdown are two buttons: "Change Password" and "Delete". Below the user name section is a "Permissions:" section containing a list of five items, each with a radio button:

- Calibrate and Learn (Access)
- Work Order and Part Data (Change)
- Diagnostics (Access)
- Cqm Settings (Change)
- Touch Screen (Calibrate)

Vertical scroll bars are visible on the right side of the permissions list.

User permissions are grouped by certain tasks or actions. The available selections are listed in Table 7: User permissions.

Table 7: User permissions

| Screen | Screen function |
|-------------------------------------|--|
| CQM settings (change) | Modify any settings on CQM Settings screens |
| Calibrate and learn (access) | [SCREEN ACCESS] Calibrate screen |
| | [SCREEN ACCESS] Learn screen |
| Work and part data (change) | Enter a new work order or delete a work order |
| | Modify WO size |
| | Enter a new part or delete a part |
| | Selection of analysis methods |
| | Crimp height settings |
| | Sensitivity settings |
| Network (change) | Modify any setting on network screen |
| Date/Time (change) | Modify any setting on date/time screen |
| Diagnostics (access) | [SCREEN ACCESS] Diagnostics screen |
| Maintenance (access) | [SCREEN ACCESS] Maintenance screen |
| Locale (change) | Modify thousands separator |
| | Modify decimal separator |
| | Modify time format |
| | Modify date format |
| | Select units (metric or imperial) |
| User administration | Add users |
| | Delete users |
| | Modify permissions |
| Clear control limit | [VIRTUAL] Displayed on message dialog |
| Touch screen (calibrate) | Enable touch screen calibration |
| Printer setup (access) | [SCREEN ACCESS] Printer screen |



NOTE

Users can always change their own passwords. The ADMIN user can change any user's password. (There is no separate permission that allows a non-ADMIN user to change another user's password.)

6.4 Locale Settings

Touch the icon to select the Locale screen. The thousands separator, decimal symbol, time format, date format, and default units selection can be made in this screen.

Figure 40: Locale settings

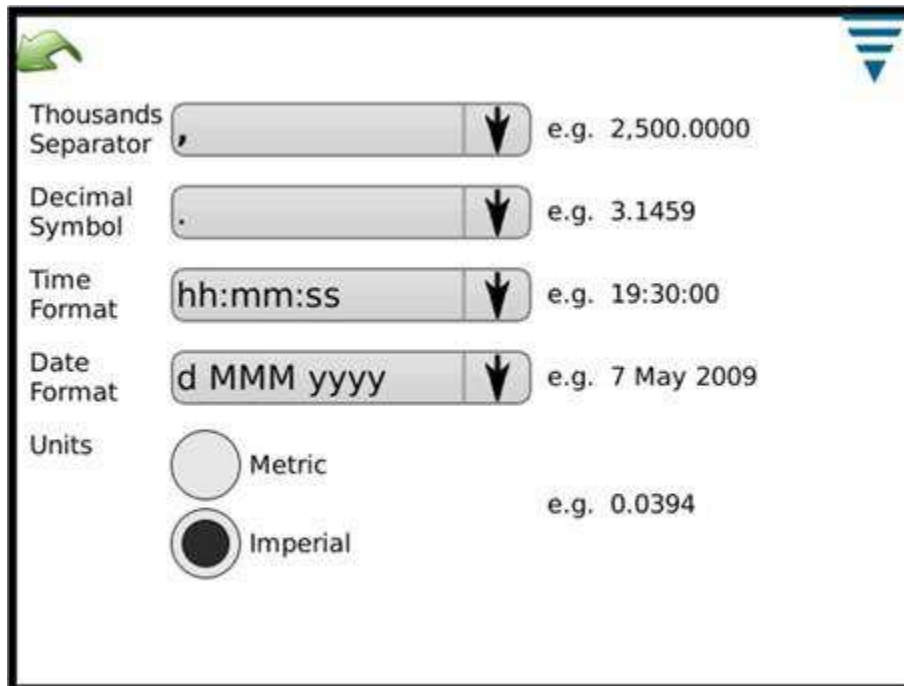

The screenshot shows the 'Locale settings' screen with the following options:

- Thousands Separator:** A dropdown menu showing a comma (,) with an example of 'e.g. 2,500.0000'.
- Decimal Symbol:** A dropdown menu showing a period (.) with an example of 'e.g. 3.1459'.
- Time Format:** A dropdown menu showing 'hh:mm:ss' with an example of 'e.g. 19:30:00'.
- Date Format:** A dropdown menu showing 'd MMM yyyy' with an example of 'e.g. 7 May 2009'.
- Units:** Two radio button options: 'Metric' (unselected) and 'Imperial' (selected). An example of 'e.g. 0.0394' is shown to the right.

6.4.1 Date/Time Settings

Touch the icon to select the Date and Time screen. The time and date formats are set in the Locale section of the Control Panel.

6.4.1.1 Date

Set the year, month, and day. Then choose SET

Figure 41: Setting the date

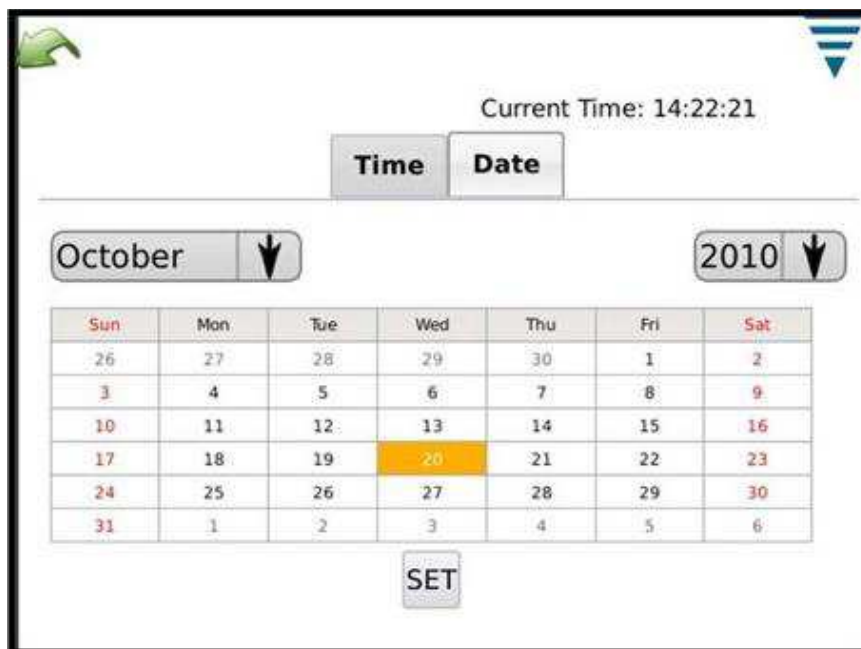

6.4.1.2 Time

Set the time. Then chose SET.

Figure 42: Setting the time

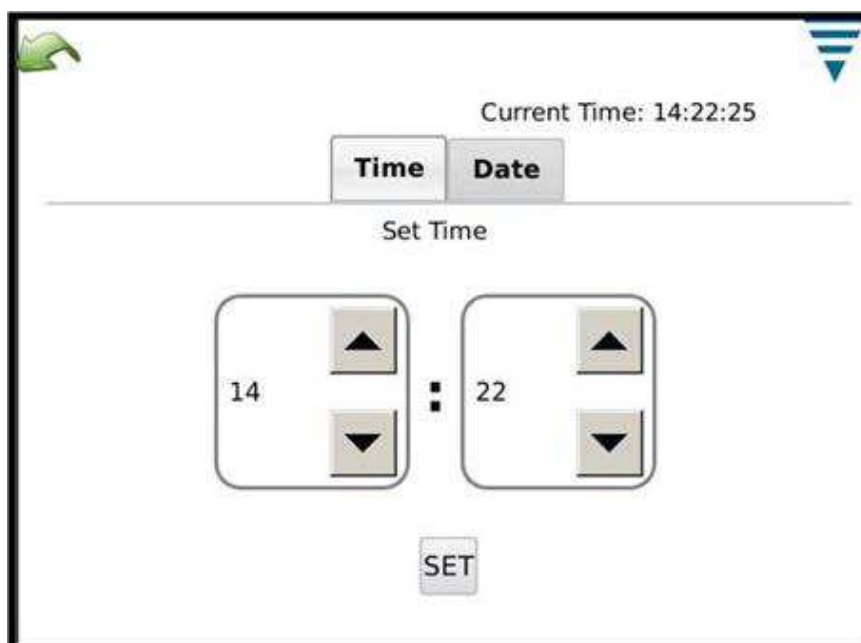

6.4.2 Reports

Touch the icon to select the “Reports” screen.



NOTE

The reports screen is a very busy screen and it may be easier to navigate by plugging in a USB mouse.)



NOTE

The reports screen is a spreadsheet that contains past history of production work orders or parts that have been run. Each entry is referred to as an “Instance.”

The Reports Screen gives access to the data and history of all the crimps analyzed by the CQM unit. The results of every crimp is stored in a database on the unit. Each crimp is organized by a PRODUCTION RUN. The run will be unique for each combination of Work Order, Part Number, Batch Size and Total Size. Each time the production counts are reset a new PRODUCTION RUN will be created. All crimps will be included in the PRODUCTION RUN including sample, calibration, learn, Pass and Fail crimps.

Figure 43: Reports

| Work Order | Part | Time Stamp | Batch Size | Total Size |
|-------------|-------------|-------------------------|------------|------------|
| TOP-ACCOUNT | 61118-14AWG | 2010-11-12T14:08:51.546 | 2 | 10 |
| | P1 | 2010-11-12T13:36:58.274 | 0 | 0 |
| | P1 | 2010-11-10T13:10:38.264 | 0 | 0 |
| | P1 | 2010-11-10T13:01:55.916 | 0 | 0 |
| | | 2010-11-10T12:45:50.288 | 0 | 0 |

Press on table to retrieve crimp data from the run.

6.4.2.1 Production Run View

When the Reports Screen is opened initially the data table will show a list of all the PRODUCTION RUNS and some summary data. The PRODUCTION RUNS are sorted so that the last production run is at the top. The table can be sorted by any column by clicking on the column header. The scroll bar at the side or in some cases along the bottom will allow the operator to see more of the data table.

6.4.2.2 Pressing on the Row

Pressing on the row for a PRODUCTION RUN will allow the operator to see more detailed information about the crimps in the run (Figure 44).

Figure 44: Crimps in a production run

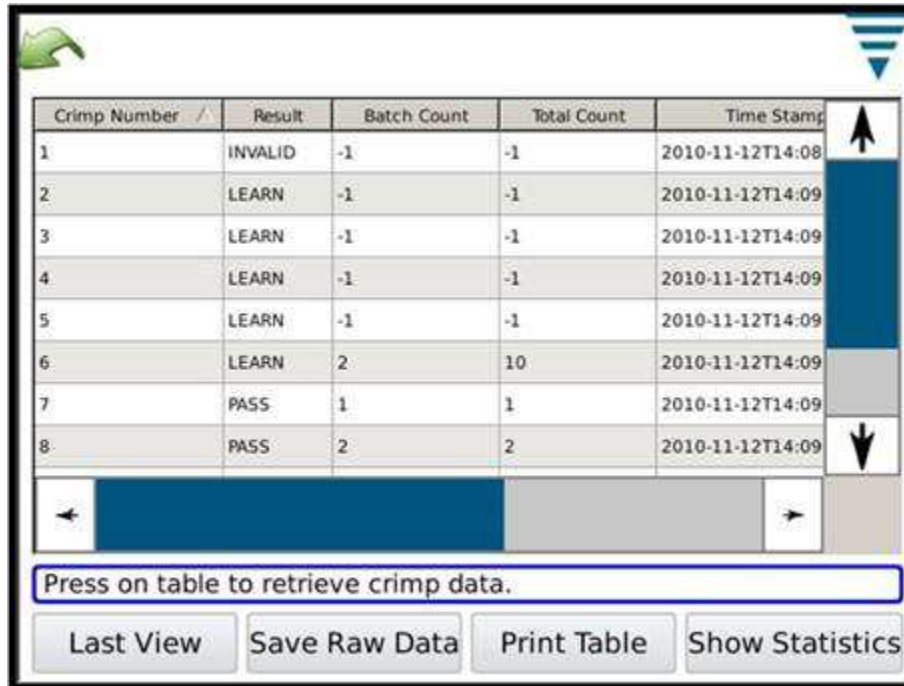

| Crimp Number | Result | Batch Count | Total Count | Time Stamp |
|--------------|---------|-------------|-------------|------------------|
| 1 | INVALID | -1 | -1 | 2010-11-12T14:08 |
| 2 | LEARN | -1 | -1 | 2010-11-12T14:09 |
| 3 | LEARN | -1 | -1 | 2010-11-12T14:09 |
| 4 | LEARN | -1 | -1 | 2010-11-12T14:09 |
| 5 | LEARN | -1 | -1 | 2010-11-12T14:09 |
| 6 | LEARN | 2 | 10 | 2010-11-12T14:09 |
| 7 | PASS | 1 | 1 | 2010-11-12T14:09 |
| 8 | PASS | 2 | 2 | 2010-11-12T14:09 |

Press on table to retrieve crimp data.

Last View Save Raw Data Print Table Show Statistics

6.4.2.3 "Print Table" Button

On each view of the data table it is possible to press the "Print Table" button. When this button is pressed all the data in the table will be displayed in a view screen that will allow it to be printed or saved to a pdf file. In this way the operator can get a printed record of the data that is viewed in the table.

6.4.2.4 "Last View" Button

Pressing this button will return the data table to the last view.

6.4.2.5 Production Detail View

When the detailed data on the production run is displayed each crimp and its results are shown. You will see the Crimp Number, Overall Result, Batch Count, Total Count, Time Stamp, Part Number, Crimp Mode of each individual crimp.

Table 8: Description of data

| Field | Description |
|-----------------------|---|
| Crimp number | A unique identifier for the crimp in the production run. |
| Overall result | The final result of the crimp based on all the analysis methods active. |
| Batch count | Number of PASS crimps in the batch after time of crimp. |
| Total count | Number of PASS crimps in the production run after the crimp. |
| Time stamp | Coded time stamp that represents the date and time of the crimp. |
| Part number | Part number of the crimp. |
| Crimp mode | Mode of the CQM unit when the crimp was made. |

Table 9: Mode description

| Field | Description |
|--|---|
| SAMPLE_MODE | Crimps that are done when the CQM II is in sample mode. In the sample mode, no analysis is performed on the crimp and its result is INVALID. |
| CALIBRATE_GAIN_MODE and CALIBRATE_CRIMP_HEIGHT_MODE | These are crimps that are done setting the force gain and crimp height reference. These crimps have result of INVALID because no analysis can be done yet |
| LEARN_MODE | These crimps are used to create the reference of good crimps. Learned crimps are accepted or rejected by the user. |
| PRODUCTION_MODE | These are crimps that are fully analyzed by all the analysis methods that is active at the time of the crimp. If the overall result is PASS then counts are added to the Batch and Total count. If the over all result is FAIL then the counts are unchanged. |

6.4.2.5.1 Detailed Information About a Crimp

Pressing on the row of a specific crimp will show the detailed information about the crimp and its results.

6.4.2.5.1.1 Crimp Detail View

This view shows all the details for the crimp. The crimp data and the results at the time of the crimp are shown. The data shown is complete.

Table 10: Crimps details

| Description | Value |
|----------------|-------------------------|
| instance_id | 5 |
| crimp_id | 7 |
| overall_result | PASS |
| batch_count | 1 |
| total_count | 1 |
| time_stamp | 2010-11-12T14:09:06.154 |
| cqm_number | 0 |
| idle_force | 91 |
| idle_position | 2030 |
| part_name | 61118-14AWG |

Crimp data is shown. Crimp:5,7

Last View Save Raw Data Print Table Show Statistics

Table 11: Crimp result data

| Field | Description |
|--------------------------|---|
| Instance ID | Production run identifier |
| Crimp ID | Unique identifier for the crimp in the production run |
| Overall result | Final result of all the analysis methods |
| Batch count | Number of PASS crimps in the batch after the crimp |
| Total count | Number of PASS crimps in the production run after the crimp |
| Time stamp | Coded time stamp that represents the date and time of the crimp |
| CQM number | Source CQM unit number (always 0) |
| Idle force | Idle force detected when the crimp occurred |
| Idle position | Idle position detected when the crimp occurred |
| Part name | Part name |
| Sequence position | Position in the sequence (always 1) |
| Crimp mode | CQM unit mode when the crimp occurred. |
| Crimp number | Number of crimps since powered on. |

Table 12: Calibrate results data (only shown for Calibrate crimps)

| Field | Description |
|-----------------------------------|--|
| Gain value | Gain value after the gain calibration crimp |
| Hand measured crimp height | Entered measured crimp height during calibration |
| Calibrate result | True or false |

Table 13: Crimp height history data (only shown for production mode crimps)

| Field | Description |
|--------------------------------|---|
| Crimp result | PASS or FAIL from crimp height analysis |
| Measured crimp height | Crimp height value from the crimp height analysis |
| UCL | Upper control limit |
| LCL | Lower control limit |
| Nominal crimp height | Crimp height desired and set in the part |
| Control limit | Value calculated or set in the part |
| Calculate control limit | True or false |
| Crimp height tolerance | Allowable tolerance set in the part |

Table 14: Peak force history data (peak force analysis)

| Field | Description |
|--------------------------|---|
| Peak force result | PASS, FAIL, or LEARN from peak force analysis |
| Force | Peak force value from the peak force analysis |
| UCL | Upper control limit |
| LCL | Lower control limit |
| Sensitivity | Sensitivity setting for the peak force analysis |

Table 15: Work index history data (work index analysis)

| Field | Description |
|--------------------------|---|
| Work index result | PASS, FAIL, or LEARN from work index analysis |
| Work index | Work index value from the work index analysis |
| UCL | Upper control limit |
| LCL | Lower control limit |
| Sensitivity | Sensitivity setting for the work index analysis |

Table 16: P2P history data (point to point analysis)

| Field | Description |
|-------------------|---|
| P2P result | PASS, FAIL, or LEARN from point to point analysis |
| Value | Point to point value from the point to point analysis |

Table 17: FFT history data (fast Fourier transform analysis)

| Field | Description |
|------------------------|---|
| FFT result | PASS, FAIL, or LEARN from FFT analysis |
| Value | FFT value from the FFT analysis |
| Above count | Number of frequencies that are above the mean |
| Below count | Number of frequencies that are below the mean |
| Failure code | Code for internal use |
| Sensitivity | Sensitivity setting for the FFT analysis |
| Threshold | Threshold level in % for FFT analysis |
| Force threshold | Actual force value of the threshold |

6.4.2.5.1.2 Statistics View

When the “Show Statistics” button is pressed the statistics for the selected production run is displayed. From this screen the statistics report can be viewed, saved, or printed.

A summary of the production run is shown. For the Crimp Height, Work Index and Peak Force analysis the statistics are displayed if they are active in this production run.

The statistics shown are Mean, Standard Deviation, CP, and CPK along with nominal and limit values.

Figure 45: Statistics view

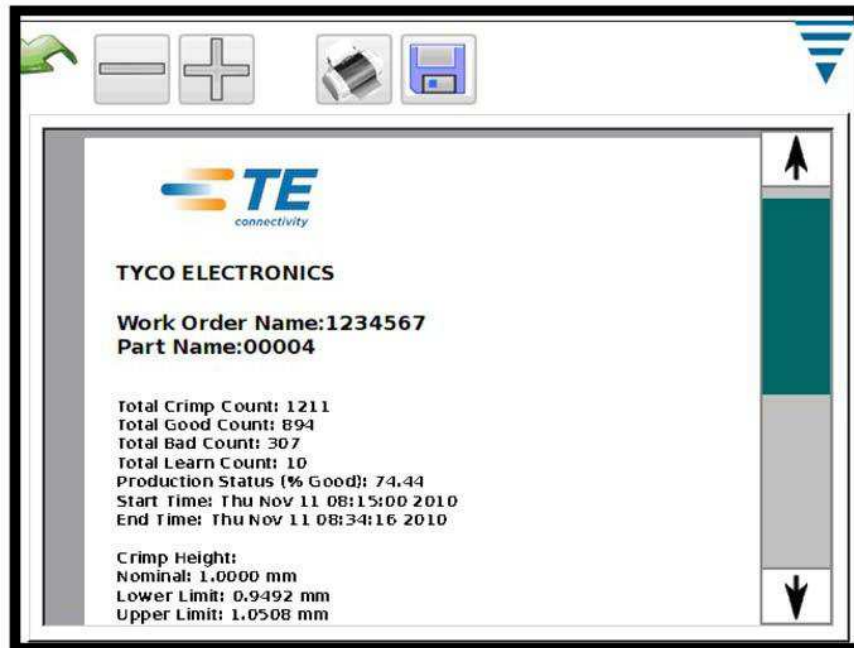

6.4.2.5.1.3 Raw Data Output File

When the “Save Raw Data” button is pressed all the data about the selected production run will be saved to a file. The file is a comma delimited file suitable to be viewed in a spreadsheet program like Microsoft Excel.

The first and second line shows the Production Run information.

Then each crimp and its results are listed. The column data is the same as that shown in the Crimp Detail View. This comma delimited file can be used to analyze the production results.

Figure 46: Raw data spreadsheet

| instance_id | work_order_name | sequence_name | sequence_part_list | time_stamp | batch_size | total_size | crimp_result_instance_id | crimp_result_overall_result | crimp_result_batch_count | crimp_result_total_count | crimp_result_time_stamp | crimp_result_cpn_number | crimp_result_idle_face | crimp_result_idle_position | crimp_result_part_name |
|-------------|-----------------|---------------|--------------------|----------------------------|-----------------------------|------------|--------------------------|-----------------------------|--------------------------|--------------------------|-------------------------|-------------------------|------------------------|----------------------------|------------------------|
| 36 | 1234567 | | | 4 2010-11-11 108 14 23 305 | 100 | 1000 | | | | | | | | | |
| 36 | | 1 | INVALID | -1 | -1 2010-11-11 108 14 45 202 | 0 | 35 | | | | | | | | 17250 |
| 36 | | 2 | INVALID | -1 | -1 2010-11-11 108 14 45 403 | 0 | 12 | | | | | | | | 17250 |
| 36 | | 3 | INVALID | -1 | -1 2010-11-11 108 14 46 302 | 0 | 73 | | | | | | | | 17261 |
| 36 | | 4 | INVALID | -1 | -1 2010-11-11 108 14 51 367 | 0 | 67 | | | | | | | | 17251 |
| 36 | | 5 | INVALID | -1 | -1 2010-11-11 108 14 51 869 | 0 | 25 | | | | | | | | 17249 |
| 36 | | 6 | INVALID | -1 | -1 2010-11-11 108 14 54 742 | 0 | 27 | | | | | | | | 17246 |
| 36 | | 7 | INVALID | -1 | -1 2010-11-11 108 14 56 876 | 0 | 26 | | | | | | | | 17261 |
| 36 | | 8 | LEARN | -1 | -1 2010-11-11 108 15 00 114 | 0 | 19 | | | | | | | | 17258 |
| 36 | | 9 | LEARN | -1 | -1 2010-11-11 108 15 00 697 | 0 | 15 | | | | | | | | 17260 |
| 36 | | 10 | LEARN | -1 | -1 2010-11-11 108 15 01 146 | 0 | 63 | | | | | | | | 17247 |
| 36 | | 11 | LEARN | -1 | -1 2010-11-11 108 15 01 713 | 0 | 15 | | | | | | | | 17258 |
| 36 | | 12 | LEARN | -1 | -1 2010-11-11 108 15 02 200 | 0 | 16 | | | | | | | | 17247 |
| 36 | | 13 | FAIL | -1 | -1 2010-11-11 108 15 05 596 | 0 | 72 | | | | | | | | 17249 |
| 36 | | 14 | FAIL | -1 | -1 2010-11-11 108 15 06 244 | 0 | 61 | | | | | | | | 17245 |
| 36 | | 15 | FAIL | -1 | -1 2010-11-11 108 15 06 872 | 0 | 20 | | | | | | | | 17256 |
| 36 | | 16 | PASS | 1 | 1 2010-11-11 108 15 07 519 | 0 | 36 | | | | | | | | 17262 |
| 36 | | 17 | FAIL | 1 | 1 2010-11-11 108 15 08 111 | 0 | 76 | | | | | | | | 17247 |
| 36 | | 18 | PASS | 2 | 2 2010-11-11 108 15 08 738 | 0 | 33 | | | | | | | | 17261 |
| 36 | | 19 | PASS | 3 | 3 2010-11-11 108 15 09 363 | 0 | 30 | | | | | | | | 17258 |
| 36 | | 20 | PASS | 4 | 4 2010-11-11 108 15 10 413 | 0 | 13 | | | | | | | | 17260 |
| 36 | | 21 | PASS | 5 | 5 2010-11-11 108 15 11 131 | 0 | 8 | | | | | | | | 17258 |
| 36 | | 22 | PASS | 6 | 6 2010-11-11 108 15 12 163 | 0 | 74 | | | | | | | | 17234 |
| 36 | | 23 | PASS | 7 | 7 2010-11-11 108 15 12 852 | 0 | 34 | | | | | | | | 17257 |
| 36 | | 24 | PASS | 8 | 8 2010-11-11 108 15 13 161 | 0 | 67 | | | | | | | | 17258 |
| 36 | | 25 | PASS | 9 | 9 2010-11-11 108 15 13 652 | 0 | 15 | | | | | | | | 17257 |
| 36 | | 26 | PASS | 10 | 10 2010-11-11 108 15 13 152 | 0 | 64 | | | | | | | | 17260 |
| 36 | | 27 | PASS | 11 | 11 2010-11-11 108 15 13 661 | 0 | 13 | | | | | | | | 17254 |
| 36 | | 28 | PASS | 12 | 12 2010-11-11 108 15 20 152 | 0 | 26 | | | | | | | | 17248 |
| 36 | | 29 | PASS | 13 | 13 2010-11-11 108 15 20 661 | 0 | 67 | | | | | | | | 17241 |
| 36 | | 30 | PASS | 14 | 14 2010-11-11 108 15 21 159 | 0 | 80 | | | | | | | | 17250 |
| 36 | | 31 | PASS | 15 | 15 2010-11-11 108 15 21 659 | 0 | 67 | | | | | | | | 17260 |
| 36 | | 32 | PASS | 16 | 16 2010-11-11 108 15 22 168 | 0 | 74 | | | | | | | | 17264 |
| 36 | | 33 | PASS | 17 | 17 2010-11-11 108 15 22 659 | 0 | 71 | | | | | | | | 17253 |
| 36 | | 34 | PASS | 18 | 18 2010-11-11 108 15 23 159 | 0 | 62 | | | | | | | | 17255 |
| 36 | | 35 | FAIL | 18 | 18 2010-11-11 108 15 23 658 | 0 | 73 | | | | | | | | 17261 |
| 36 | | 36 | PASS | 19 | 19 2010-11-11 108 15 24 152 | 0 | 29 | | | | | | | | 17259 |
| 36 | | 37 | FAIL | 19 | 19 2010-11-11 108 15 24 664 | 0 | 23 | | | | | | | | 17256 |
| 36 | | 38 | PASS | 20 | 20 2010-11-11 108 15 25 156 | 0 | 76 | | | | | | | | 17260 |
| 36 | | 39 | FAIL | 20 | 20 2010-11-11 108 15 25 664 | 0 | 20 | | | | | | | | 17253 |
| 36 | | 40 | PASS | 21 | 21 2010-11-11 108 15 26 159 | 0 | 77 | | | | | | | | 17259 |
| 36 | | 41 | FAIL | 21 | 21 2010-11-11 108 15 26 652 | 0 | 66 | | | | | | | | 17258 |
| 36 | | 42 | PASS | 22 | 22 2010-11-11 108 15 27 166 | 0 | 32 | | | | | | | | 17244 |
| 36 | | 43 | FAIL | 22 | 22 2010-11-11 108 15 27 652 | 0 | 60 | | | | | | | | 17238 |
| 36 | | 44 | PASS | 23 | 23 2010-11-11 108 15 28 159 | 0 | 29 | | | | | | | | 17252 |
| 36 | | 45 | FAIL | 23 | 23 2010-11-11 108 15 28 664 | 0 | 14 | | | | | | | | 17255 |

6.4.3 Report Setup

Touch the icon to select the Report Setup screen.

This mode allows you to format the statistic reports that are generated for printing or saving as a pdf to a USB Flash drive.

Touch the Company Name and enter the name you choose.

You can import an image, for example your company logo, by touching the Choose File button. The image must be either a PNG (*.png) or JPEG (*.jpg or *.jpeg) image format. It will be scaled to fit an area that is 200 x 50 pixels. You may need to edit the image first so that it will scale correctly. The image needs to be placed on a USB Flash Drive before selecting Choose File. After the image is loaded it will be shown in the Image Preview area.

Choose Paper/Output size to select between Letter or A4 size paper.

Figure 47: Report setup dialog

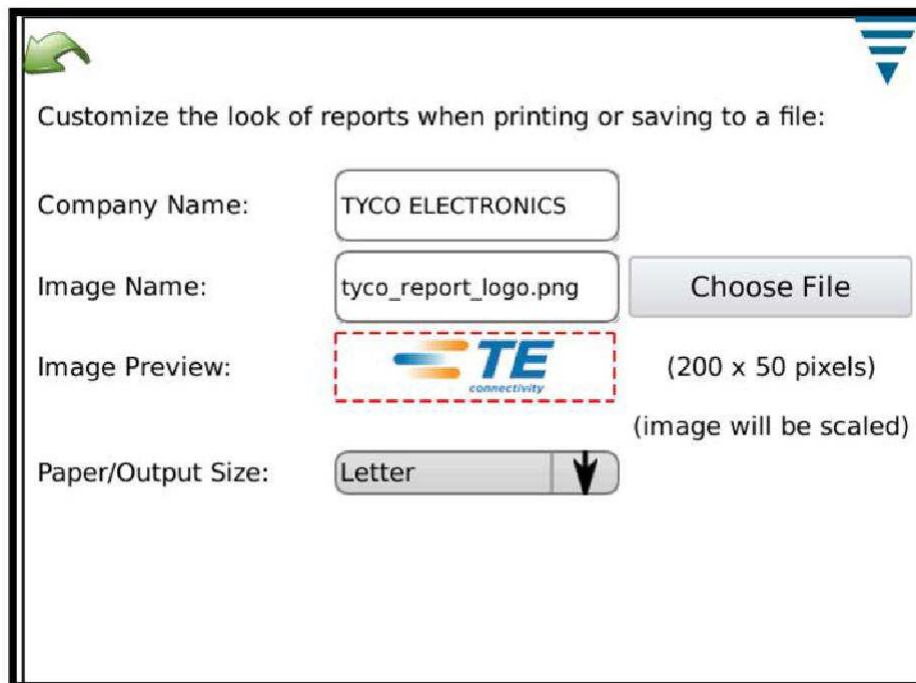

6.4.4 Curve History Graph

Touch the icon to select the Crimp History Graph screen.

The Crimp History Graph is a diagnostic tool that displays actual raw data curves for both the force and position sensors. The data is not filtered so a curve may look slightly different from the graphs shown in the other modes. They are shown displaying the time and date of the crimp. Only the last 50 crimps are available for viewing. Raw crimp data is lost when power is turned off.

Touch Compare On/Off to display two curves: one red, one black. Use the upper two arrows to change the black crimp that is showing and the lower two arrows for the red crimp that is showing.

Touch the Save Crimp Curve History button to save data from the 50 Crimp Curves. This is raw data that is saved in a comma delimited file and is useful for TE personnel to diagnose potential issues with the CQM.

6.4.5 Network

The CQM can be connected to a network via its ethernet connection. Currently, the CQM only supports network printing. No other network functionality is supported with the current release. Future versions may offer additional functionality. Someone in your company's IT organization may need to be involved with setting the CQM network.

The Network screen has two tabs, Configuration, and Status.

6.4.5.1 Configuration tab

Hostname: A unique name to identify each CQM on the network. The CQM will be reachable via this hostname on the .local domain, for example, "hostname.local", by any computer configured to be able to resolve link-local hostnames (also known as Zeroconf, or Bonjour (Apple Computer's trademark name for Zeroconf networking)). Apple computers running Mac OSX, and most Linux distributions have Zeroconf already configured. It can be added to computers running Microsoft's Windows XP, Vista, or Windows 7 operating systems with the Apple Bonjour program, <http://support.apple.com/kb/DL999>.

Figure 48: Configuration tab

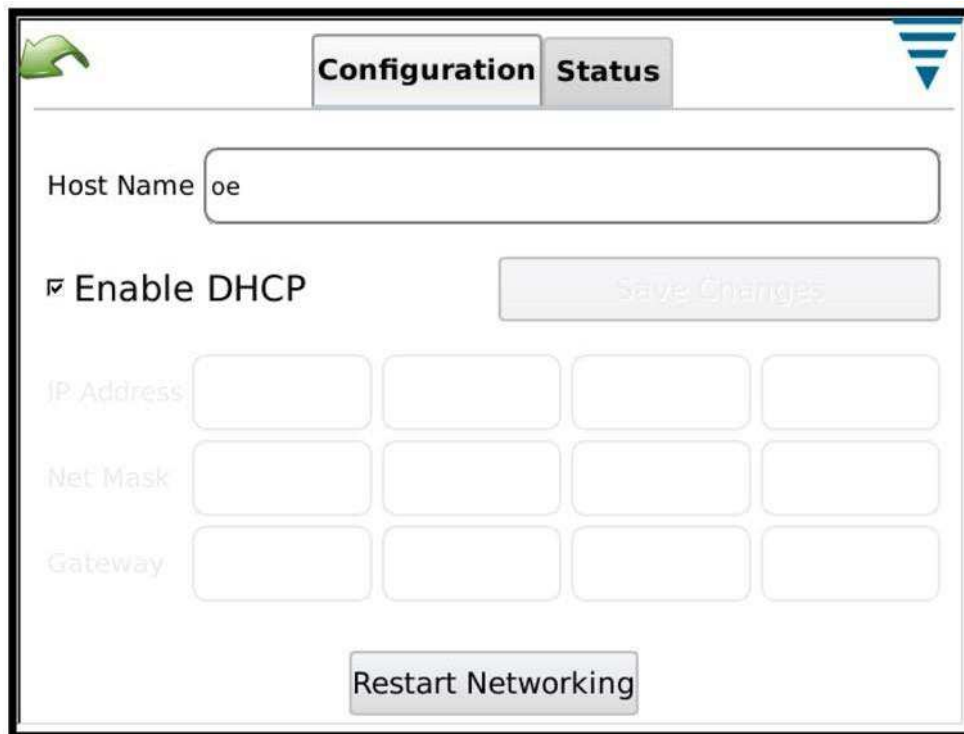

The screenshot shows a web-based configuration interface for network settings. At the top, there are two tabs: "Configuration" (active) and "Status". A green arrow icon is on the left, and a blue triangle icon is on the right. Below the tabs, there is a "Host Name" field with the text "oe" entered. Below that is a checked checkbox labeled "Enable DHCP" and a "Save Changes" button. Underneath are three rows of input fields: "IP Address", "Net Mask", and "Gateway", each with four individual input boxes. At the bottom, there is a "Restart Networking" button.

6.4.5.2 Status Tab

Displays the current IP address for the CQM.

The Restart Networking button should be used whenever the CQM is connected to a different network while it is already powered up, and will cause the CQM to attempt to configure its IP address if DHCP is enabled.

If connected to a network with a DHCP server, such as a corporate network, home internet gateway, or router, the CQM obtains its IP address from the DHCP server. If no DHCP server is available, such as when connecting directly to a computer or other CQM with a crossover cable, or when one or more CQM's are connect to a network hub or switch that is not part of a larger network, the CQM will configure a "self-assign" network address with the following format 169.254.x.x (where x.x are unique for each CQM).

Figure 49: Status tab

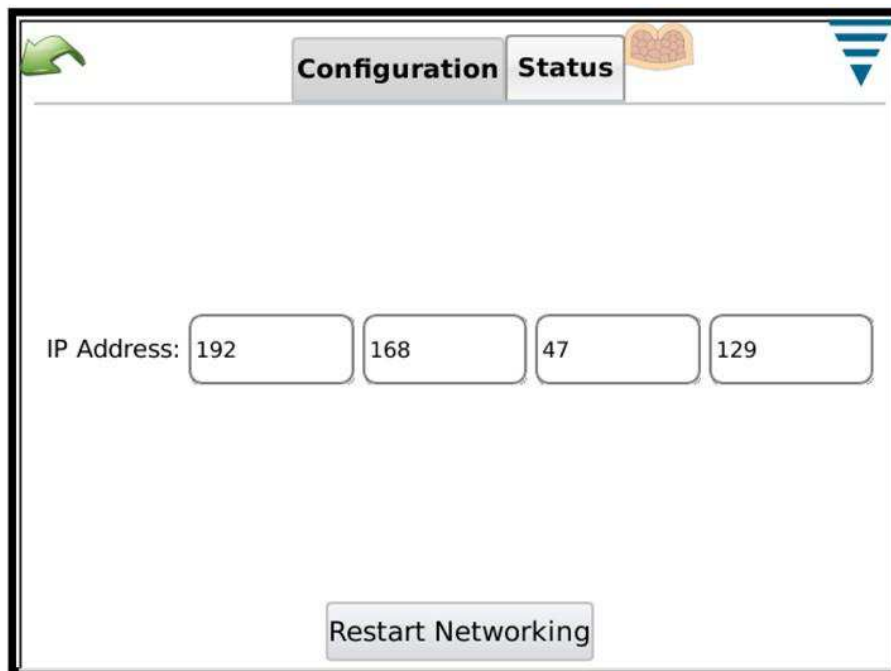

6.4.6 Display Settings

Touch the icon to select the Display Settings screen. You can adjust the display brightness and screen saver time out by touching on the pointer on the slider and dragging it.

When the screen saver is active, the display will be dark and the LED on the Host will be amber. Simply touch the display and it will return to the normal operating state.

Figure 50: Display settings dialog

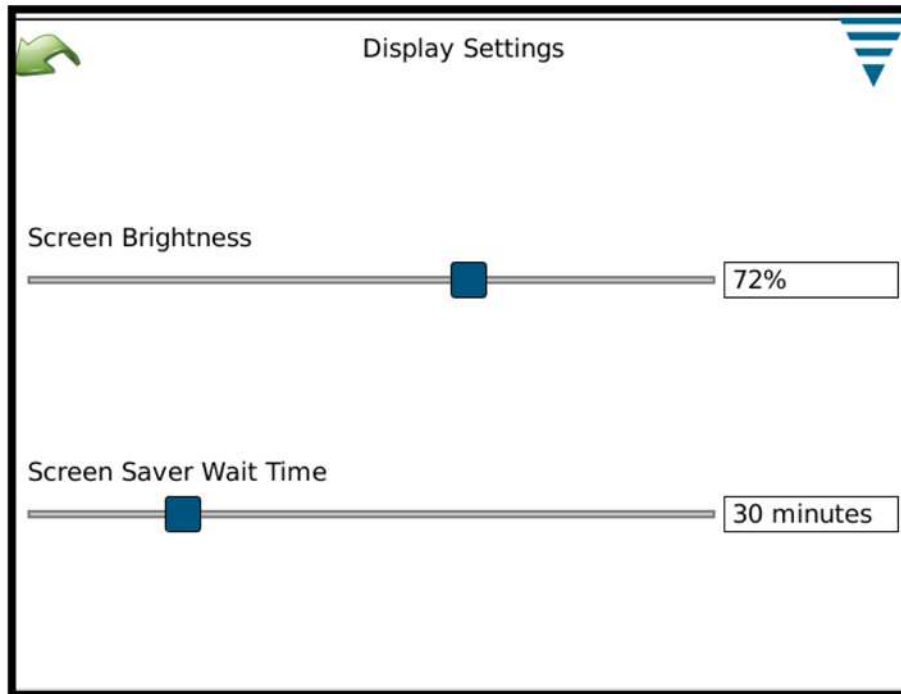

6.4.7 Calibrate Touchscreen

Touch the icon to select the Calibrate Touch screen. Calibration of the touch screen is performed at initial build and should not be required unless something happens with the integrity of the touch surface. Choose Calibrate Touch and follow the on screen instructions. When complete, you must choose Accept.

i **NOTE**
Use a plastic stylus for accurate calibration.

i **NOTE**
The screen indicates where you should touch, but the lower left image is not presented well. It is similar to the other corners. Touch it the same way.

i **NOTE**
Calibrate Touch has a time limit for touching each corner of the display and for final Acceptance. If you take too long, the calibration aborts.

Figure 51: Touch screen calibration dialog

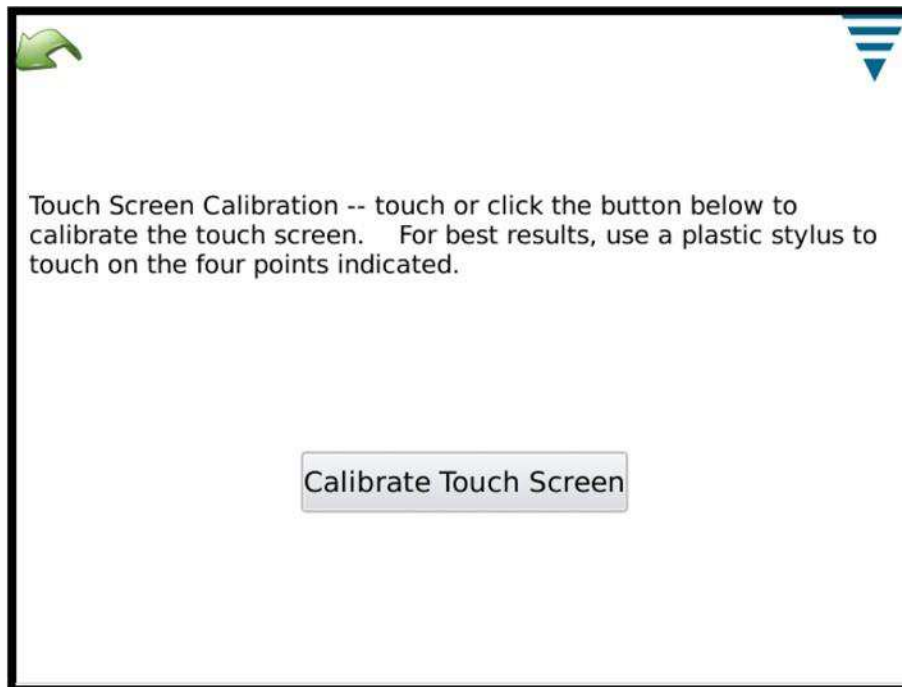

6.4.8 Maintenance

The Maintenance section is provided for authorized users to see information about the system and to perform data maintenance.

6.4.8.1 About Tab

This screen displays the various Licenses for third-party software used in the application.

Figure 52: About tab



6.4.8.2 Quit Tab

This screen is used to quit the software application.

 **NOTE**
Quit only when instructed to do so by TE personnel.

6.4.8.3 Version tab

This screen displays the various software versions that are currently installed on the CQM.

Figure 53: Version tab

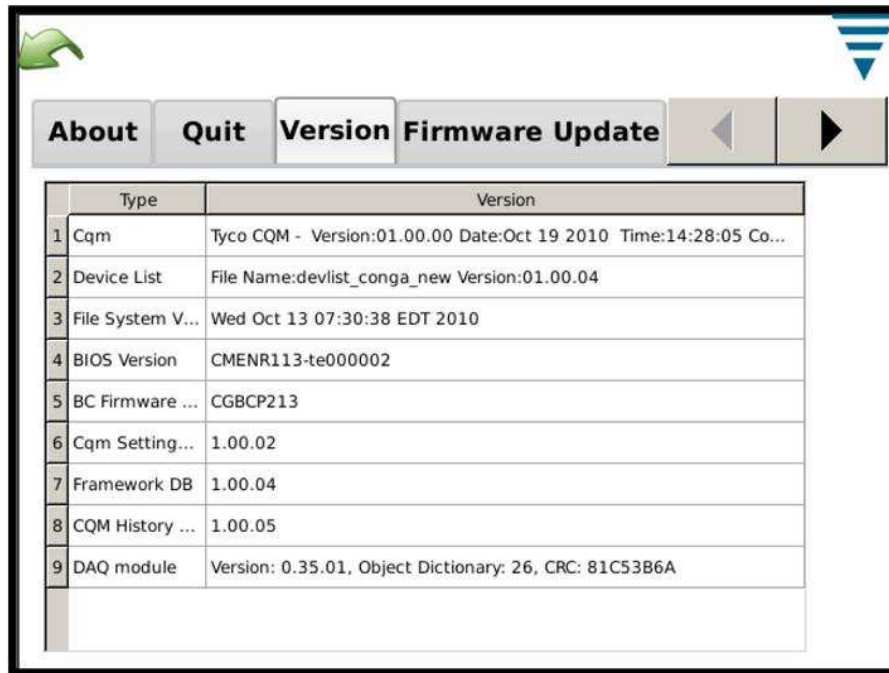

The screenshot shows a software interface with a top navigation bar containing buttons for 'About', 'Quit', 'Version', and 'Firmware Update'. The 'Version' button is currently selected. Below the navigation bar is a table with two columns: 'Type' and 'Version'. The table lists various system components and their installed versions.

| | Type | Version |
|---|------------------|--|
| 1 | Cqm | Tyco CQM - Version:01.00.00 Date:Oct 19 2010 Time:14:28:05 Co... |
| 2 | Device List | File Name:devlist_conga_new Version:01.00.04 |
| 3 | File System V... | Wed Oct 13 07:30:38 EDT 2010 |
| 4 | BIOS Version | CMENR113-te000002 |
| 5 | BC Firmware ... | CGBCP213 |
| 6 | Cqm Setting... | 1.00.02 |
| 7 | Framework DB | 1.00.04 |
| 8 | CQM History ... | 1.00.05 |
| 9 | DAQ module | Version: 0.35.01, Object Dictionary: 26, CRC: 81C53B6A |

6.4.8.4 Firmware Update Tab

This screen is used to update the firmware on the CQM. Follow the onscreen instructions.

 **NOTE**
Update the firmware **only** when instructed to do so by TE personnel.

Figure 54: Firmware update tab



6.4.8.5 File Operations Tab

This screen is used for certain file operations. Follow the on screen instructions.

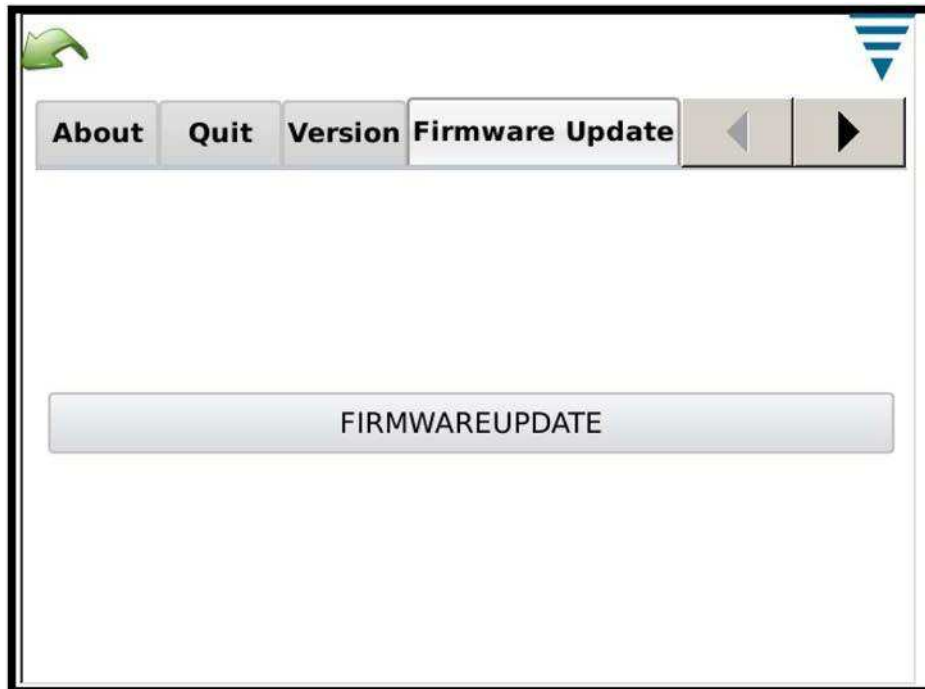
Figure 55: File operations tab

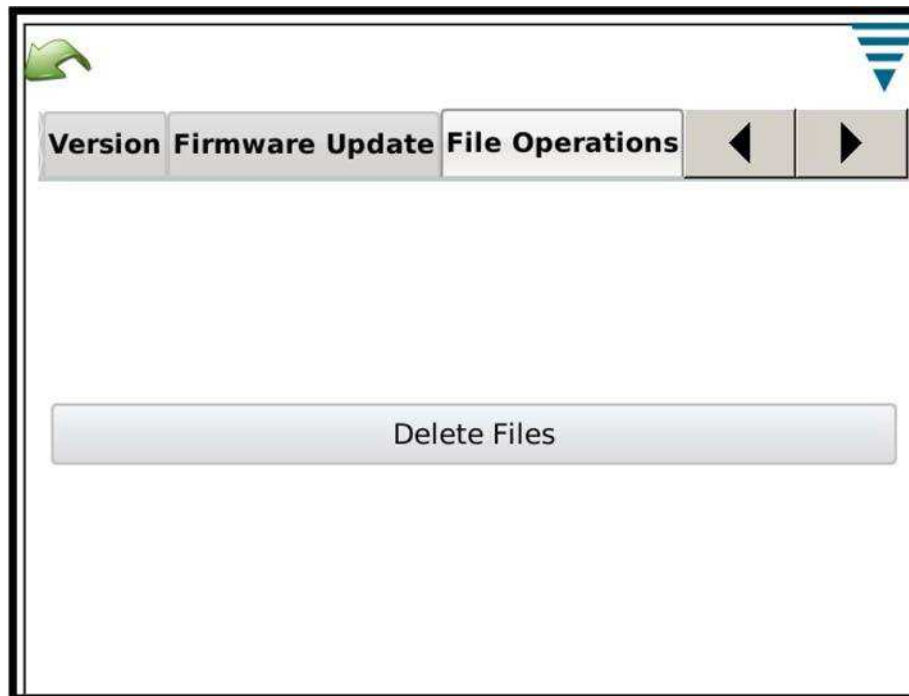

6.4.8.6 Database Operations Tab

This screen is used to backup and restore the system database. Choose the appropriate selection and follow the on screen instructions. Backup to a USB flash drive is provided for secure backup and restoration.

Figure 56: Database operations tab

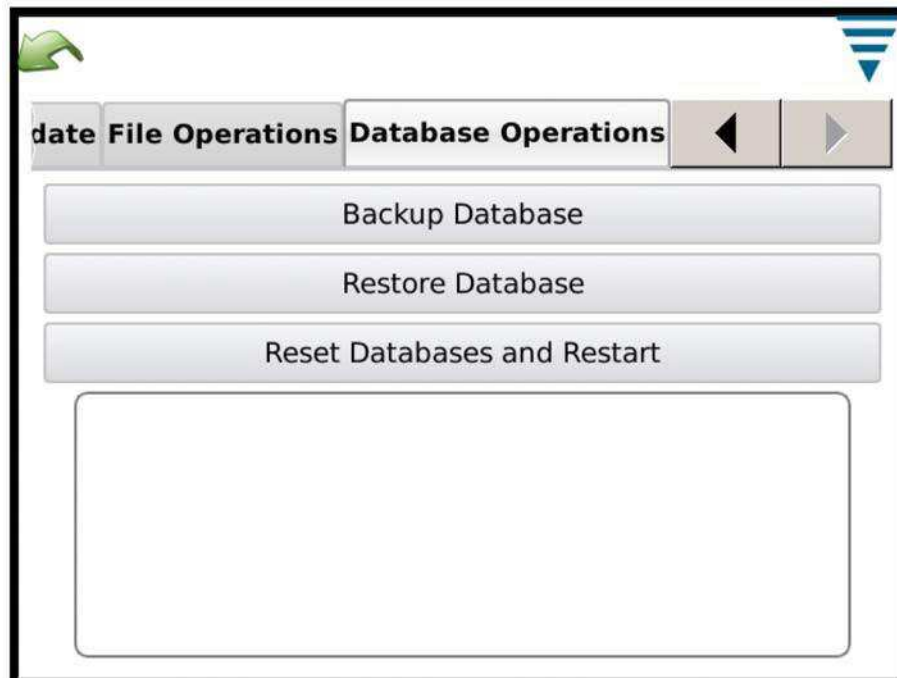

6.4.9 Diagnostics

The Diagnostics section is provided for authorized users to monitor the hardware status of the system.

6.4.9.1 Health Monitor Tab

The Health Monitor screen displays the internal temperatures of various components within the system.

Figure 57: Health Monitoring tab

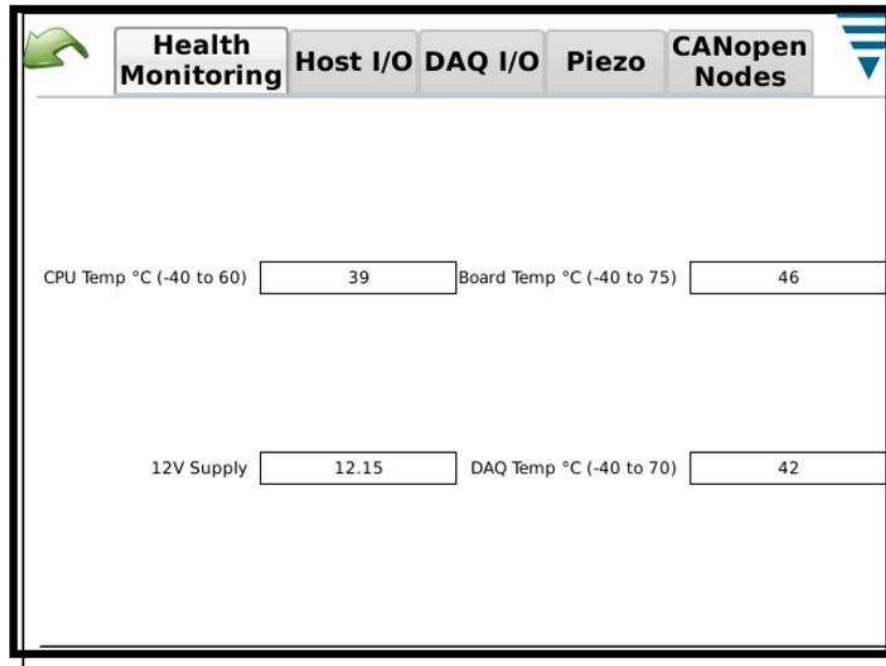

6.4.9.2 Host I/O Tab

The Host I/O screen displays the status of the modules Inputs and Outputs. Output states can be changed by touching the appropriate icon.

i **NOTE**
 Change output states **only** when instructed to do so by TE personnel.

Figure 58: Host I/O tab

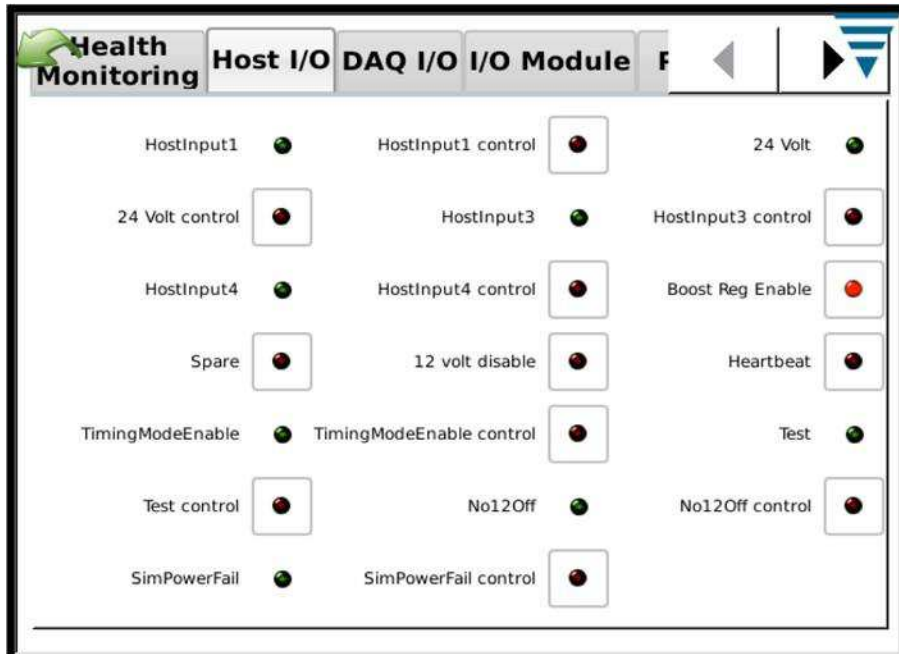

6.4.9.3 DAQ I/O Tab

The DAQ I/O screen displays the status of the modules Inputs and Outputs. Output states can be changed by touching the appropriate icon.

Figure 59: DAQ I/O tab

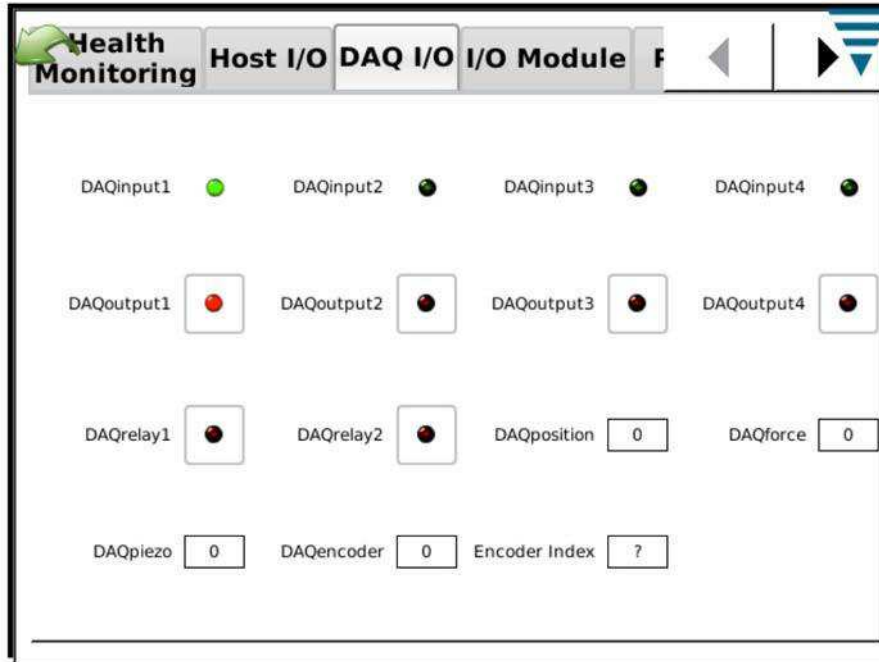

6.4.9.4 Piezo Tab

The Piezo screen provides a means to diagnose the Piezo sensor input.

i **NOTE**
Perform this diagnosis **only** when instructed to do so by TE personnel.

Figure 60: Piezo tab

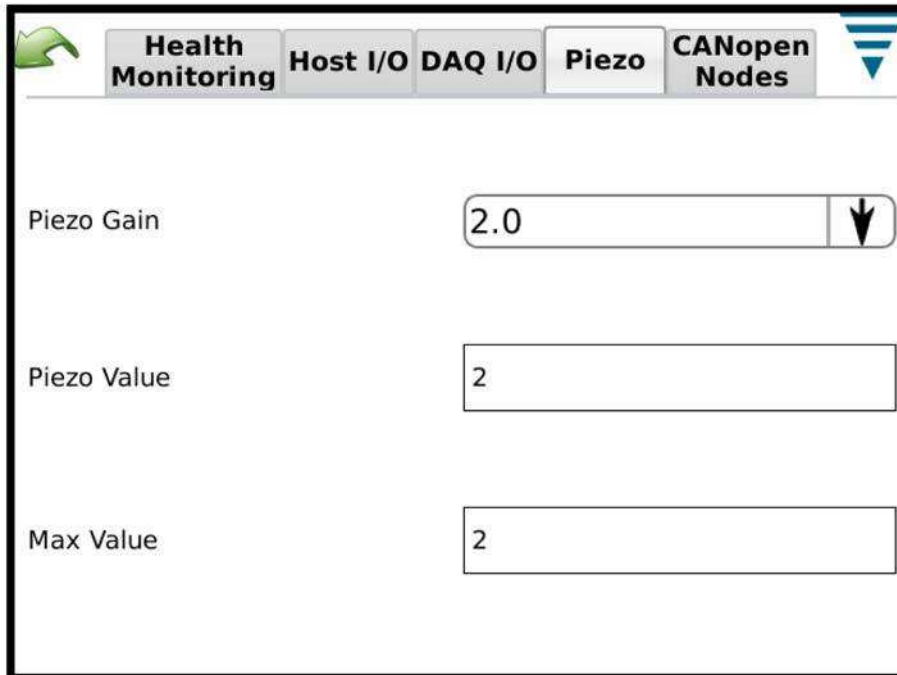

The screenshot shows a software interface with a top navigation bar containing five tabs: Health Monitoring, Host I/O, DAQ I/O, Piezo, and CANopen Nodes. The Piezo tab is currently selected. Below the tabs, there are three input fields:

| | |
|-------------|----------------------------------|
| Piezo Gain | <input type="text" value="2.0"/> |
| Piezo Value | <input type="text" value="2"/> |
| Max Value | <input type="text" value="2"/> |

6.4.9.5 CANOpen Node Tab

The CANOpen Node screen provides information regarding the CAN address of the attached modules.

Figure 61: CANOpen Node tab

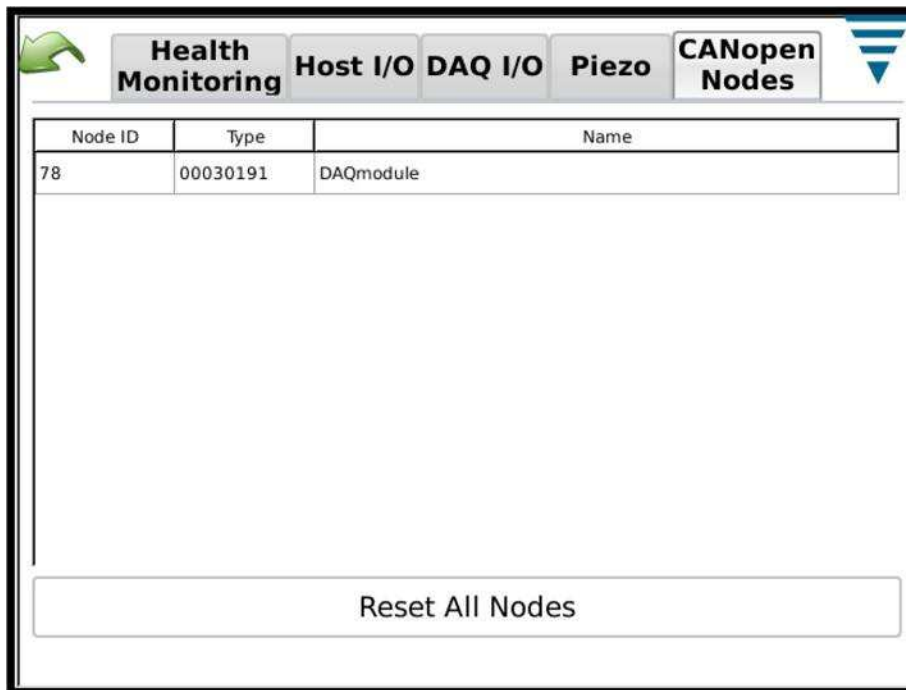

6.4.10 Error Log Viewer

The Error Log Viewer provides a list of various errors, system setting changes, etc. that may be useful for diagnosing system problems. Specific instructions will be provided by TE personnel to use this feature.

Figure 62: Error Log Viewer

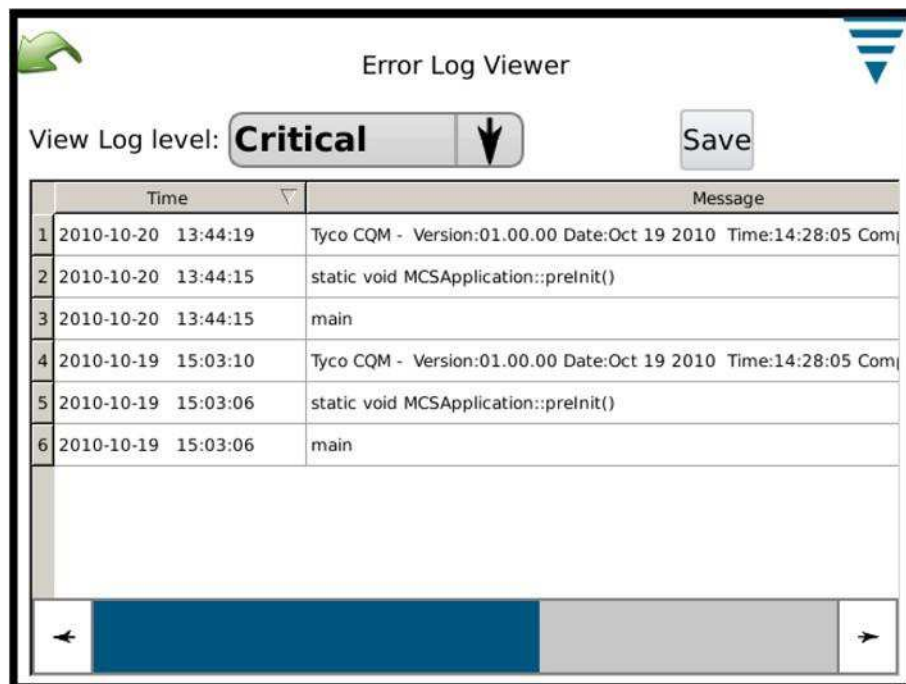

6.4.11 Demo

The Demo selection is primarily used for demonstration and training purposes. When placed in the Demo mode, the unit restarts the application utilizing a different database so as to not corrupt the main database. Most all functionality exists in the Demo mode, but a real terminator with sensors is not needed. When you're on the screens that you would typically perform a crimp, just touch the 'Virtual' crimp button on the screen to perform the crimp. Data from a stored crimp will be used and all screens will appear as though a normal crimp occurred.

Figure 63: Starting a demo

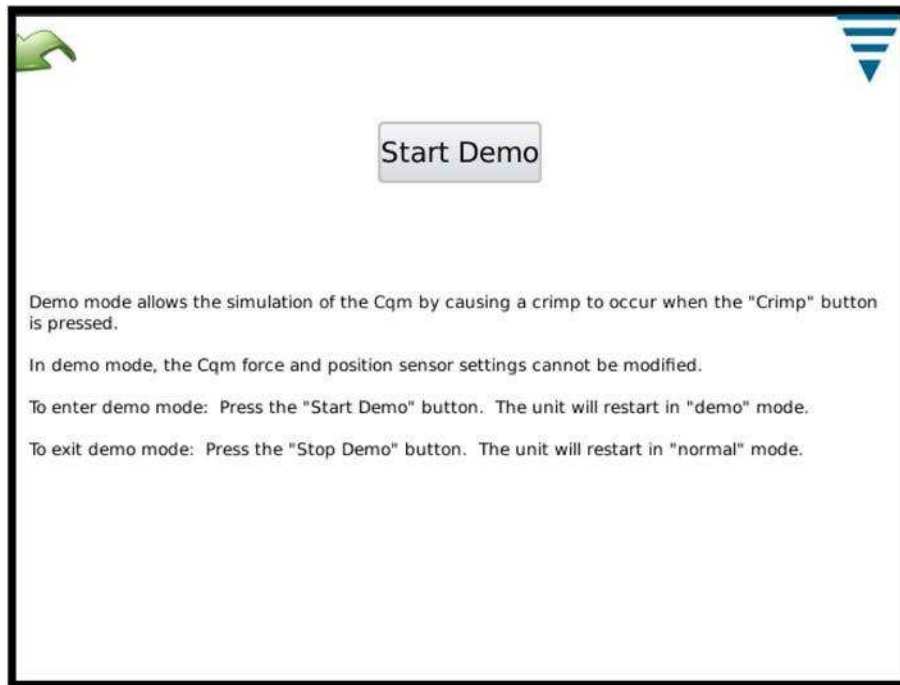

6.4.12 Printer Icon

This screen is used to select the appropriate printer for the CQM.

The CQM can print to a local, USB-connected printer, or to some network printers. Printers connected via USB-serial or USB-parallel port adapters are not supported in the CQM.

The CQM supports a wide variety of printers. It uses the Gutenprint printer driver. A list of supported printers is available on the Gutenprint website.

Even if a printer is not on this list of supported printers, it will usually work with a driver for a similar printer. For example, the HP Photosmart D5300 series printer is not on the list of supported printers, but selecting the "HP Photosmart 7150 – CUPS+Gutenprint" driver works just fine.

From the Control Panel, touch the Printer Icon to enter the printer setup and configuration screens. To configure a local printer, connect the printer via one of the two USB ports on side of the CQM Host. Then touch the "Add New Printer Button", and follow the prompts to select a printer driver.

To configure a supported network printer, touch "Use Network Printers". The CQM will automatically discover any supported network printers and add them to the drop-down list at the top of the screen. Simply touch the drop down list to select which printer to use. The CQM supports printing to printers connected to other CQM's, and to any shared printer connected to a computer that uses the Apple CUPS printer system. Computers running Apple's Mac OS X, and most Linux or Unix distributions support CUPS printing.

The CQM can also print to other network printers using the LPR, IPP, or SMB (Windows) protocols. Many of the standalone network printer server devices support LPR printing (it may be necessary to enable LPR

printing, as it may be disabled by default). Printing to printers with these protocols can be configured via the CUPS web interface using a web browser on any PC. To access the CUPS web interface, obtain the CQM's IP address via the Network Status screen, and then browse to the following URL: "http://x.x.x.x:631", where "x.x.x.x" is the IP address of the CQM. Then click on "Administration", and "Add Printer". Under "Other Network Printers", select the network printer type, and click "Continue", and then enter the appropriate information at the subsequent screens. The printer should now appear in the "Current" printer selection drop down box. It may be necessary to exit the printer setup screen, and reenter it for the printer to appear in the list.

Through this web interface, it is possible to configure many different kinds of network printers that cannot be added automatically as outlined above, including Windows printers, HP JetDirect, LPR/LPD, just to name a few.

Microsoft Windows (both desktop and server versions) require a username and password to print to shared printers via the Micro SMB protocol (if selecting "Windows Printer via "SAMBA" as the network type) which is the default protocol for sharing printers on Windows Servers, however, most versions of Windows Server support LPR printing – contact your LAN administrator for further support with printing to printers which are connected to Windows servers.

6.4.12.1 Windows (SMB) Protocol

To print to a Windows printer use the following format for the "Connection" (this entry is a "URI", which is similar to a web URL):

```
smb://username:password@DOMAIN/hostname/printer_name
```

DOMAIN is your login domain on a corporate network using Active Directory. It can be omitted (along with the slash between it and the hostname) if on a small LAN that doesn't use Active Directory.

For further support with printing to printers that are connected to Windows servers, contact your LAN administrator.

6.4.12.2 Line Printer Daemon (LPD) Protocol

LPR/LPD printers use the following Connection format:

```
lpd://hostname/printer_name
```

6.4.12.3 Internet Printing Protocol (IPP)

IPP is the only protocol that CUPS supports natively and is supported by some network printers and print servers. However, many printers do not implement IPP properly. Use IPP only when the vendor actually documents official support for it. IPP printing normally happens over port 631 and uses the http and ipp URI schemes:

```
http://ip-address-or-hostname:port-number/resource
```

```
http://ip-address-or-hostname:port-number/resource?option=value
```

```
http://ip-address-or-hostname:port-number/resource?option=value&option=value  
ipp://ip-address-or-hostname/resource
```

```
ipp://ip-address-or-hostname/resource?option=value
```

```
ipp://ip-address-or-hostname/resource?option=value&option=value  
ipp://ip-address-or-hostname:port-number/resource
```

```
ipp://ip-address-or-hostname:port-number/resource?option=value
```

```
ipp://ip-address-or-hostname:port-number/resource?option=value&option=value
```

Consult the [CUPS](#) website for more detailed information on configuring network printers.

It is also possible to configure more advanced features on some printers. To do so, touch the Setup Current Printer button. The Setup Current Printer screen contains settings specific to the particular printer in use. These settings are organized into categories, which can be selected with a drop-down menu at the top of the screen.

Features such as color mode, print quality, print resolution, paper tray selection, etc, can be selected on this screen. Usually, these settings can all be left at their defaults.

7 Troubleshooting

Table 18: General troubleshooting

| Problem | Corrective action |
|--|---|
| Too many crimps are failing that appear to be good. | Carefully inspect the crimp. Does it meet your quality criteria? |
| | Ensure that the tooling is in optimum condition. |
| | Reduce the sensitivity of the analysis methods. Experiment by changing the sensitivity by about 0.5 at a time. |
| | Is the headroom of the crimp above 35%? |
| Failed crimps are passing the analysis. | Carefully inspect the crimp. Does it truly fail your quality criteria? |
| | Adjust the sensitivity of the analysis methods so that they are more sensitive. Experiment by changing the sensitivity by about 0.5 at a time. |
| | Is the headroom of the crimp above 35%? |
| Terminator foot switch still cycles the system when the CQM failed a crimp and the operator did not respond to the error. (Depends on which host is selected.) | Is the appropriate host system selected in the CQM Settings? |
| | Is the interface cable connected to the DAQ module and the host terminator? |
| | Is the interface cable damaged? |
| | If the system is on a non-TE terminator, has it been properly connected? |
| The touch screen does not respond. | Plug in a USB mouse and navigate to the Touch Screen calibrate mode. Start the calibration with the mouse, and then proceed with touching the screen. If touches are not recognized, the unit is not working correctly. You can continue to operate the system with the USB mouse or return it for repair or replacement. |
| The touch screen responds intermittently | Recalibrate the Touch Screen. |
| | Plug in a USB mouse to navigate to the Touch Screen calibration. |

Table 19: Non-valid crimps during Learn

| Possible cause | Corrective action |
|--|--|
| On terminators with an analog height sensor, the coefficients are incorrect or have not been entered | Verify and correct any settings as necessary |
| Disconnected or damaged cables | Correct any problems with the cables |
| CQM II settings for the position and force sensors do not match the sensors that are installed on the terminator | Verify and correct any settings as necessary |
| Damaged or defective sensors | Verify sensor operation by jogging the terminator while observing the sensor readings on the Diagnostic DAQ I/O page |
| An analysis method does not work for an unusual crimping application | Use the Reports screen to examine any INVALID crimps that occurred in Learn_mode* |
| (APT terminators only) Gain is set too high. | Manually reduce the gain by going into "Diagnostics" and opening the "Piezo" tab. |

*Any crimp done on the sample screen is reported as INVALID because it is not analyzed. You want to look at the crimps that are reported as INVALID in LEARN_MODE. Table 20 lists the fields where the status is displayed.

Table 20: Status fields

| Field | Analysis method |
|-------------------|-----------------|
| crimp_result | Crimp height |
| peak_force_result | Peak force |
| work_index_result | Work index |
| p2p_result | Point to point |
| fft_result | FFT |

You can turn off any analysis method that reports the crimp as INVALID. As an alternative, try your application with one analysis method at a time to determine whether a single method is causing you problems.

7.1 Additional information for specific sensors

7.1.1 Linear Encoder

- Is the correct Position Sensor selected in CQM Settings?
- Is the encoder cable connected to the DAQ module?
- Check for damaged encoder cable. If it is damaged, replace it.
- The encoder reader head has a LED. If the cable good and is connected to the DAQ module, and the LED is not lit, replace the encoder.
- In Diagnostics mode, observe the Encoder count while jogging the terminator. These numbers should change as the terminator RAM moves.
- The encoder reader head must be spaced ~1mm from the magnetic strip. Adjust if spacing is too large.
- Check for a damaged magnetic strip. If it is damaged, replace it.

7.1.2 Analog Height Sensor

- Is the correct Position sensor selected in CQM Settings?
- Is the cable connected to the DAQ module and the analog height sensor?
- Check for damaged cable. If it is damaged, replace it.
- In Diagnostics, observe the DAQ position number while jogging the terminator. These numbers should change as the terminator RAM moves through the bottom of the stroke.
- The analog height sensor must be spaced correctly in front of the passing magnets. Adjust if spacing is too large.
- Check for a damaged magnets set into the RAM. If they are damaged, the analog height sensor kit must be replaced.

7.1.3 Base Plate Strain Gage (Force Sensor)

- Is the correct Force Sensor selected in CQM Settings?
- Is the cable connected to the DAQ module and the base plate?
- Check for damaged cable. If it is damaged, replace it.
- Check for damaged base plate in the area of the strain sensors (directly under the anvil area of an applicator). If it is damaged, replace it.
- In Diagnostics, observe the DAQ force number while pushing hard on the base plate with your thumb. The numbers should change indicating that the sensor is working properly.

7.1.4 Piezo Sensor (Force Sensor)

- Is the correct Force Sensor selected in CQM Settings?
- Is the cable connected to the DAQ module and the base plate?
- Check for damaged cable. If it is damaged, replace it.
- In Diagnostics, observe the DAQ piezo number while pushing hard on the sensor located on the terminator frame. The numbers should change indicating that the sensor is working properly.

7.1.5 Trigger Sensor (on non-TE terminators)

- Is the correct Position sensor selected in CQM Settings?
- Is the cable connected to the DAQ module?
- Check for damaged cable. If it is damaged, replace it.
- The proximity sensor must have metal directly in front of it for proper detection. Ensure sensor is mounted properly and ensure the metal target is present. If the sensor has metal in front of it, the LED on it should be lit.
- In Diagnostics, observe the DAQ input1 LED. When the sensor has metal in front of it, the LED on the screen should be lit.

8 Maintenance

The following procedures have been established to assure the quality and reliability of the CQM. The CQM should be checked daily, and a more detailed inspection should be performed (according to your quality control group) on a regular basis.

8.1 Touch screen cleaning

The front surface of the touch screen should be kept free of dirt, dust, fingerprints and other materials that could degrade optical properties. Long term contact with abrasive materials will scratch the front surface, and image quality will be detrimentally affected. For best results, use a clean, damp, nonabrasive cloth towel and any commercially available window cleaner to regularly clean the surface. The cleaning solution should be applied to the towel rather than the surface of the touch screen.

8.2 Daily maintenance

- Remove dust, moisture, and other contaminants with a clean brush, or soft, lint-free cloth. **Do not** use objects that could damage the CQM.
- Make sure all components are in place and properly secured.
- Always leave the CQM turned off for a minimum of 10 seconds before reapplying power so that the monitor initializes properly.
- Make sure that the cooling vents on the back and side panels are not blocked.

8.3 Special handling precautions for systems with the linear encoder installed



CAUTION

Do not expose the MS10 magnetic scale to magnetic flux densities higher than 50 mT on its surface. Doing so can damage the scale.

Table 21: Chemicals used to clean the magnetic strip

| Safe to use | Do not use |
|-------------|--------------------------------|
| Motor oil | Heptane |
| Brake fluid | Benzene |
| Turpentine | Toluene |
| Kerosene | Alcohol |
| Antifreeze | Ketone |
| | H ₂ SO ₄ |
| | HCl |

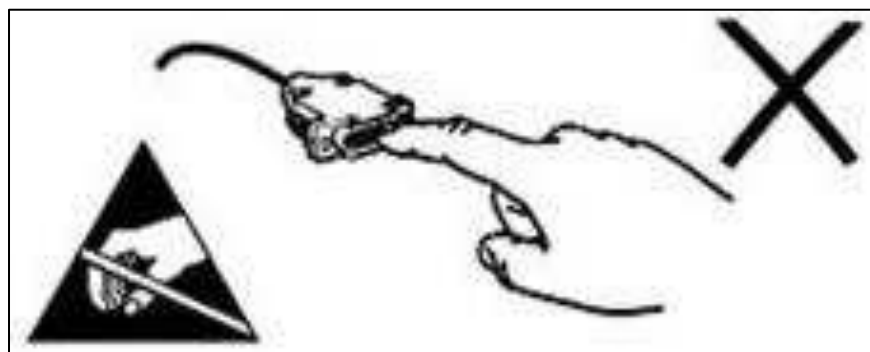

8.4 Quality control maintenance

Your quality control personnel should perform regular inspections at least once per month. A record of quality control inspections should remain with the personnel responsible for the CQM. Base your inspection frequency on operator skill, amount of use, ambient working conditions, and your company's established standards.

- Remove any accumulated film with a suitable cleaning agent.

9 Evaluation and repair

Order or return parts through your TE representative, or go to TE.com and click the **Shop TE Store** link at the top of the page.

For field service, go to the [Service and Repair](#) page on the TE website, or send an e-mail to the address for your region in Table 22.

Figure 64: Service and repair



Table 22: Field service e-mail addresses

| Region | Address |
|------------------------|--|
| Asia | Tefe1ap@te.com |
| EMEA (including India) | Tefe1@te.com |
| North America | Fieldservicesnorthamerica@te.com |
| South America | FSE@te.com |

10 Revision summary

Revisions to this customer manual include:

- Reformatted to current standard for customer manuals
- Updated Table 19: Non-valid crimps during Learn