

# CLL3H0914L-700; CLL3H0914LS-700

L-band internally pre-matched GaN-SiC HEMT **AMPLEON**

Rev. 2 — 10 January 2023

Product data sheet

## 1. Product profile

### 1.1 General description

The CLL3H0914L-700 and CLL3H0914LS-700 are 700 W internally pre-matched RF GaN-SiC HEMTs power transistors that are usable in the frequency range from 0.9 GHz to 1.4 GHz. The devices offer excellent efficiency, thermal resistance and ruggedness suitable for short- and long-pulse applications. Further, [Section 8.3](#) highlights performance curves for application reference designs at frequencies from 1.2 GHz to 1.4 GHz, 1030 MHz and 960 MHz to 1215 MHz.

**Table 1. Typical performance**

Typical RF performance at  $T_{case} = 25\text{ °C}$ ;  $t_p = 3\text{ ms}$ ;  $\delta = 10\%$ ;  $V_{DS} = 50\text{ V}$ ;  $I_{Dq} = 200\text{ mA}$ ; frequencies from 1200 MHz to 1400 MHz, tested on a straight lead device soldered in a class-AB demo circuit.

Test signal	f	P <sub>L</sub> [1]	G <sub>p</sub>	η <sub>D</sub>	RL <sub>in</sub>
	(MHz)	(W)	(dB)	(%)	(dB)
pulsed CW	1200	850	16.0	62	-12
	1300	750	16.0	71	-16
	1400	750	16.0	68	-15

[1]  $P_L = P_{L(sat)}$ .

### 1.2 Features and benefits

- 700 W internally pre-matched GaN-SiC HEMT covering a frequency range from 0.9 GHz to 1.4 GHz with internal stability network
- Low thermal resistance
- Excellent ruggedness
- High efficiency, short pulse reference designs at 960 MHz to 1215 MHz and 1030 MHz for avionics applications
- High efficiency, long pulse reference designs at 1.2 GHz to 1.4 GHz
- Typical performance features of all three reference designs summarized in [Section 8.3](#)
- For RoHS compliance see the product details on the Ampleon website

## 2. Pinning information

Table 2. Pinning

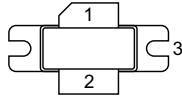
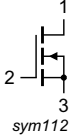
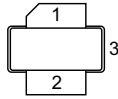
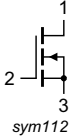
Pin	Description	Simplified outline	Graphic symbol
<b>CLL3H0914L-700 (SOT502A)</b>			
1	drain		 sym112
2	gate		
3	source <sup>[1]</sup>		
<b>CLL3H0914LS-700 (SOT502B)</b>			
1	drain		 sym112
2	gate		
3	source <sup>[1]</sup>		

[1] Connected to flange.

## 3. Ordering information

Table 3. Ordering information

Package name	Orderable part number	12NC	Packing description	Min. orderable quantity (pieces)
SOT502A	CLL3H0914L-700U	9349 603 40112	Tray; 20-fold; non-dry pack	20
SOT502B	CLL3H0914LS-700U	9349 603 39112	Tray; 20-fold; non-dry pack	20

## 4. Limiting values

Table 4. Limiting values

In accordance with the Absolute Maximum Rating System (IEC 60134).

Symbol	Parameter	Conditions	Min	Max	Unit
$V_{DS}$	drain-source voltage		-	150	V
$V_{GS}$	gate-source voltage		-8	+2	V
$I_{GF}$	forward gate current		-	36	mA
$T_{stg}$	storage temperature		-65	+150	°C
$T_{ch}$	active die channel temperature	<sup>[1]</sup>	-	225	°C

[1] Continuous use at maximum temperature will affect the reliability. For details refer to the online MTF calculator.

## 5. Thermal characteristics

**Table 5. Thermal characteristics**

Symbol	Parameter	Conditions	Typ	Unit
$Z_{th(ch-c)}$ [1]	transient thermal impedance from active die channel to case	$T_{case} = 85\text{ °C}; V_{DS} = 50\text{ V}; P_{dis} = 300\text{ W}$		
		$t_p = 100\text{ }\mu\text{s}; \delta = 10\text{ }\%$	0.12	K/W
		$t_p = 200\text{ }\mu\text{s}; \delta = 10\text{ }\%$	0.14	K/W
		$t_p = 300\text{ }\mu\text{s}; \delta = 10\text{ }\%$	0.15	K/W
		$t_p = 100\text{ }\mu\text{s}; \delta = 20\text{ }\%$	0.15	K/W
		$t_p = 500\text{ }\mu\text{s}; \delta = 20\text{ }\%$	0.19	K/W
		$t_p = 2\text{ ms}; \delta = 20\text{ }\%$	0.24	K/W
		$t_p = 1\text{ ms}; \delta = 10\text{ }\%$	0.19	K/W
		$t_p = 3\text{ ms}; \delta = 10\text{ }\%$	0.24	K/W
	steady state	0.38	K/W	

[1] Finite Element Analysis (FEA) thermal values have been used for the online MTF calculator.

## 6. Characteristics

**Table 6. DC characteristics**

$T_{case} = 25\text{ °C};$  unless otherwise specified.

Symbol	Parameter	Conditions	Min	Typ	Max	Unit
$V_{(BR)DSS}$	drain-source breakdown voltage	$V_{GS} = -8\text{ V}; I_D = 16\text{ mA}$	150	-	-	V
$V_{GS(th)}$	gate-source threshold voltage	$V_{DS} = 6\text{ V}; I_D = 1080\text{ mA}$	-	-2.9	-	V
$I_{DSX}$	drain cut-off current	$V_{GS} = 2\text{ V}; V_{DS} = 6\text{ V}$	-	75	-	A
$g_{fs}$	forward transconductance	$V_{GS} = 0\text{ V}; V_{DS} = 6\text{ V}$	-	19	-	S
$R_{Dson}$	drain-source on-state resistance	$V_{GS} = 0\text{ V}; V_{DS} = 100\text{ mV}$	-	35	-	m $\Omega$

**Table 7. RF characteristics**

Test signal: pulsed RF;  $t_p = 100\text{ }\mu\text{s}; \delta = 10\text{ }\%$ ; RF performance at  $V_{DS} = 50\text{ V}; I_{Dq} = 500\text{ mA}; T_{case} = 25\text{ °C};$  unless otherwise specified, in a class-AB production circuit, tested at frequencies from 1200 MHz to 1400 MHz.

Symbol	Parameter	Conditions	Min	Typ	Max	Unit
$P_L$	output power	$P_{L(3dB)}$	725	800	-	W
$G_p$	power gain	$P_L = 725\text{ W}$	15	17	-	dB
$\eta_D$	drain efficiency	$P_L = 725\text{ W}$	58	65	-	%
$RL_{in}$	input return loss	$P_L = 725\text{ W}$	-	-10	-	dB
$P_{droop(pulse)}$	pulse droop power	$P_L = 725\text{ W}$	-	0.1	-	dB

## 7. Application information

### 7.1 Circuit information

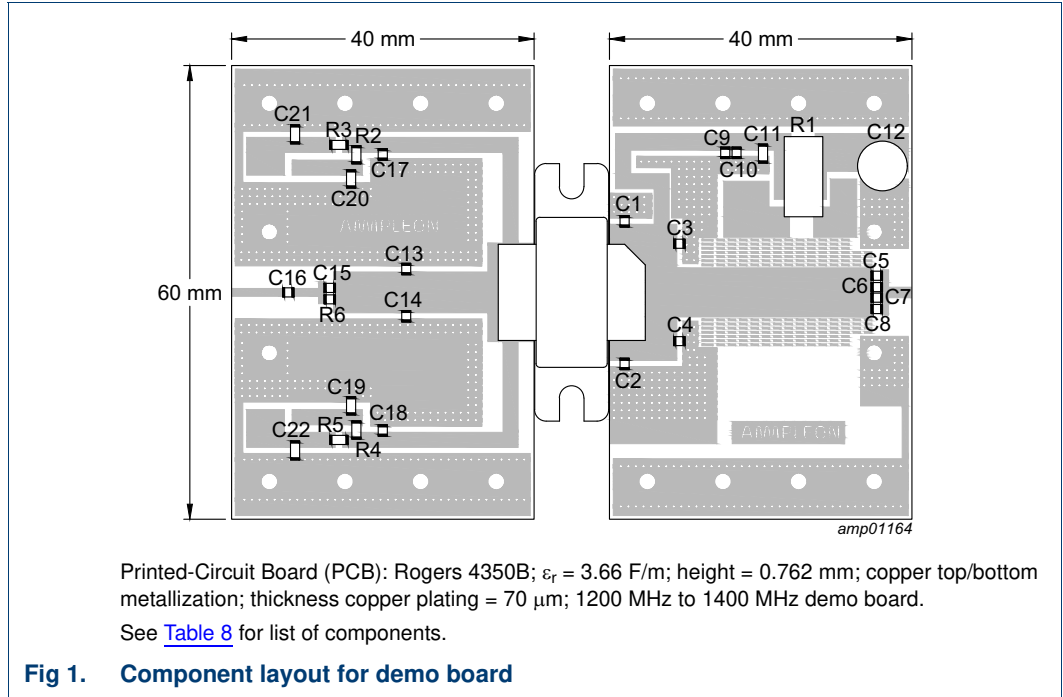

**Table 8. List of components**

For test circuit see [Figure 1](#).

Component	Description	Value	Remarks
C1, C2	multilayer ceramic chip capacitor	9.1 pF	ATC 100A
C3, C4	multilayer ceramic chip capacitor	5.1 pF	ATC 100A
C5, C6, C7, C8, C9, C10, C16	multilayer ceramic chip capacitor	100 pF	ATC 100A
C11	multilayer ceramic chip capacitor	4.7 $\mu\text{F}$ , 100 V	Murata: GRM42256X7S475K100H530
C12	electrolytic capacitor	470 $\mu\text{F}$ , 63 V	
C13, C14	multilayer ceramic chip capacitor	1.2 pF	ATC 100A
C15	multilayer ceramic chip capacitor	24 pF	ATC 100A
C17, C18	multilayer ceramic chip capacitor	72 pF	ATC 100A
C19, C20	multilayer ceramic chip capacitor	10 nF, 50 V	Murata: C1206C104K1RAC
C21, C22	multilayer ceramic chip capacitor	4.7 $\mu\text{F}$	TDK
R1	shunt resistor	10 m $\Omega$ , 5 W	
R2, R3	resistor	8.2 $\Omega$	SMD 1206
R4, R5	resistor	4.7 $\Omega$	SMD 1206
R6	shunt resistor	82 $\Omega$	SMD 0603

## 7.2 Impedance information

**Table 9. Typical impedance**  
*Typical values unless otherwise specified.*

f (MHz)	Z <sub>S</sub> (Ω)	Z <sub>L</sub> (Ω)
960	1.419 – j2.007	0.935 – j0.770
1030	1.526 – j2.099	1.053 – j0.613
1090	1.611 – j2.163	1.094 – j0.583
1150	1.638 – j2.186	1.015 – j0.588
1215	1.540 – j2.153	0.813 – j0.518
1200	1.090 – j2.359	1.337 – j0.707
1300	1.842 – j1.747	1.167 – j0.711
1400	2.215 – j1.272	0.722 – j0.604

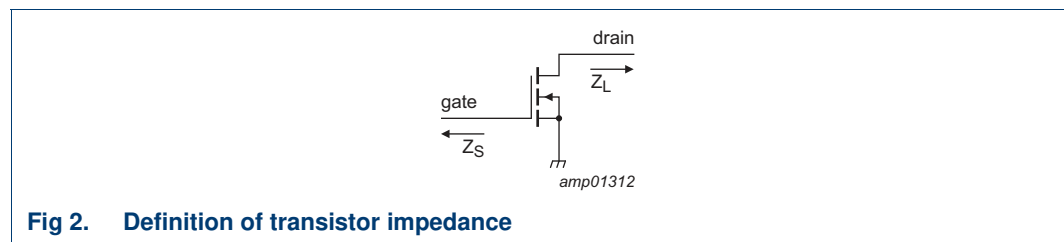

**Fig 2. Definition of transistor impedance**

## 8. Test information

### 8.1 Ruggedness in class-AB operation

The CLL3H0914L-700 and CLL3H0914LS-700 are capable of withstanding a load mismatch corresponding to VSWR = 10 : 1 through all phases under the following conditions:  $V_{DS} = 50\text{ V}$ ;  $f = 1300\text{ MHz}$  at rated load power on RF development board using a pulsed CW RF signal.

8.2 Test circuit information

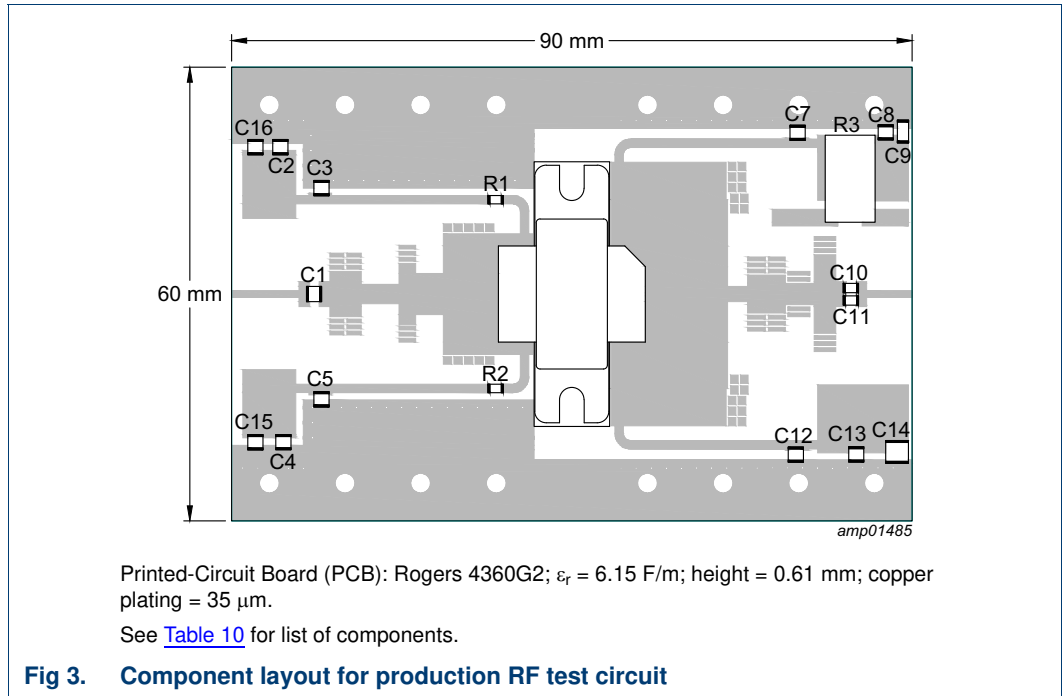

**Table 10. List of components**

For test circuit see [Figure 3](#).

Component	Description	Value	Remarks
C1, C3, C5, C7, C12	multilayer ceramic chip capacitor	430 pF	ATC 800A
C10, C11	multilayer ceramic chip capacitor	160 pF	ATC 800A
C2, C4, C8, C13	multilayer ceramic chip capacitor	1 nF	ATC 800A
C9, C14, C15, C16	multilayer ceramic chip capacitor	4.7 $\mu\text{F}$ , 100 V	GMR42 258K7S 475K 100 H53
R1, R2	resistor	5.6 $\Omega$	SMD 0603
R3	resistor	10 m $\Omega$	FC4L110R010FER

8.3 Graphical data

8.3.1 1200 MHz to 1400 MHz demo board

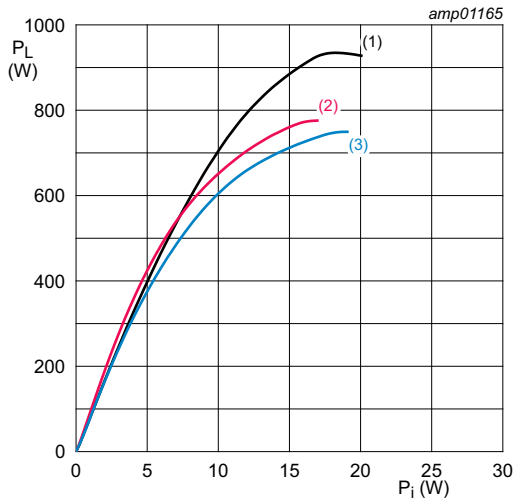

$V_{DS} = 50\text{ V}; I_{DQ} = 500\text{ mA}; t_p = 100\text{ }\mu\text{s}; \delta = 10\text{ }\%$ .  
 (1)  $f = 1200\text{ MHz}$   
 (2)  $f = 1300\text{ MHz}$   
 (3)  $f = 1400\text{ MHz}$

**Fig 4. Output power as a function of input power; typical values**

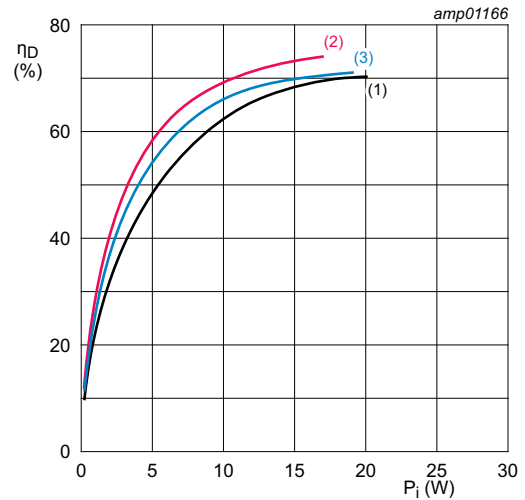

$V_{DS} = 50\text{ V}; I_{DQ} = 500\text{ mA}; t_p = 100\text{ }\mu\text{s}; \delta = 10\text{ }\%$ .  
 (1)  $f = 1200\text{ MHz}$   
 (2)  $f = 1300\text{ MHz}$   
 (3)  $f = 1400\text{ MHz}$

**Fig 5. Drain efficiency as a function of input power; typical values**

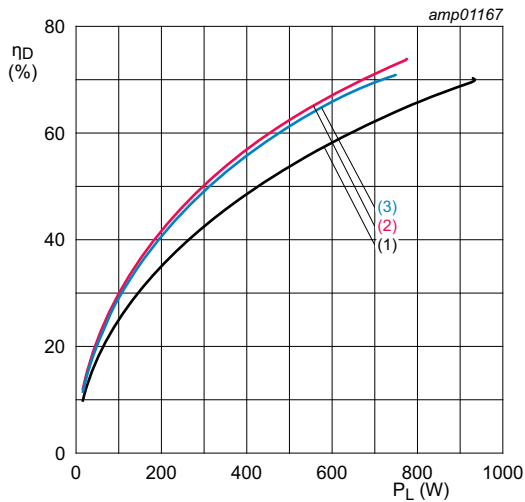

$V_{DS} = 50\text{ V}; I_{DQ} = 500\text{ mA}; t_p = 100\text{ }\mu\text{s}; \delta = 10\text{ }\%$ .  
 (1)  $f = 1200\text{ MHz}$   
 (2)  $f = 1300\text{ MHz}$   
 (3)  $f = 1400\text{ MHz}$

**Fig 6. Drain efficiency as a function of output power; typical values**

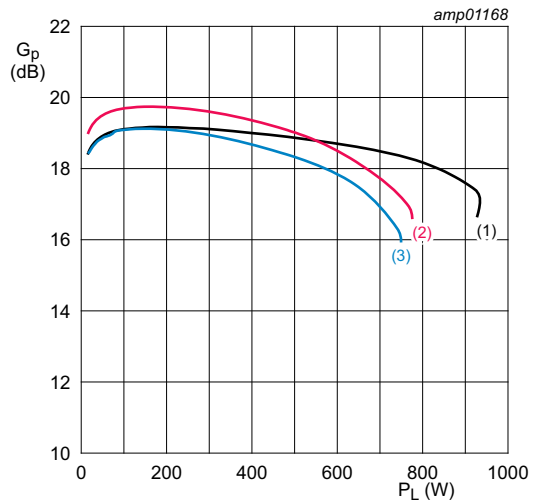

$V_{DS} = 50\text{ V}; I_{DQ} = 500\text{ mA}; t_p = 100\text{ }\mu\text{s}; \delta = 10\text{ }\%$ .  
 (1)  $f = 1200\text{ MHz}$   
 (2)  $f = 1300\text{ MHz}$   
 (3)  $f = 1400\text{ MHz}$

**Fig 7. Power gain as a function of output power; typical values**

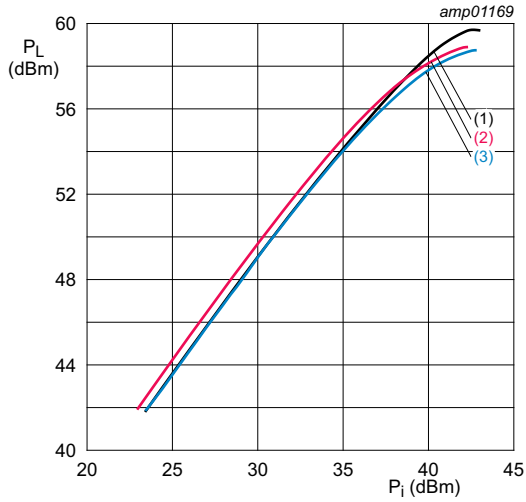

$V_{DS} = 50\text{ V}$ ;  $I_{DQ} = 500\text{ mA}$ ;  $t_p = 100\text{ }\mu\text{s}$ ;  $\delta = 10\text{ }\%$ .  
 (1)  $f = 1200\text{ MHz}$   
 (2)  $f = 1300\text{ MHz}$   
 (3)  $f = 1400\text{ MHz}$

**Fig 8. Output power as a function of input power; typical values**

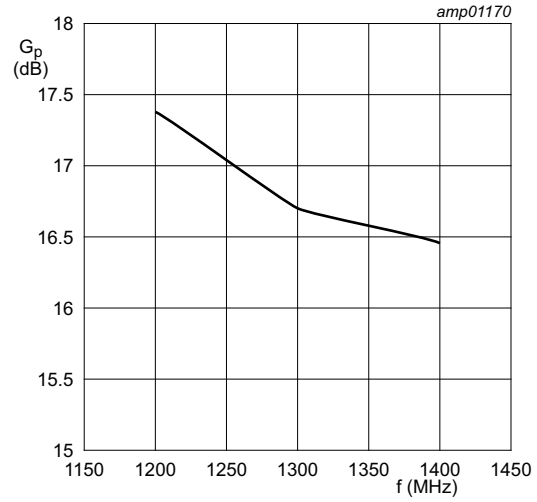

$V_{DS} = 50\text{ V}$ ;  $I_{DQ} = 500\text{ mA}$ ;  $P_i = 42.3\text{ dBm}$ ;  $t_p = 100\text{ }\mu\text{s}$ ;  $\delta = 10\text{ }\%$ .

**Fig 9. Power gain as a function of frequency; typical values**

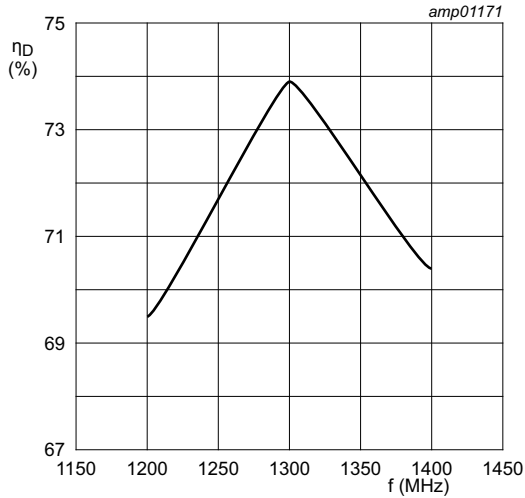

$V_{DS} = 50\text{ V}$ ;  $I_{DQ} = 500\text{ mA}$ ;  $P_i = 42.3\text{ dBm}$ ;  $t_p = 100\text{ }\mu\text{s}$ ;  $\delta = 10\text{ }\%$ .

**Fig 10. Drain efficiency as a function of frequency; typical values**

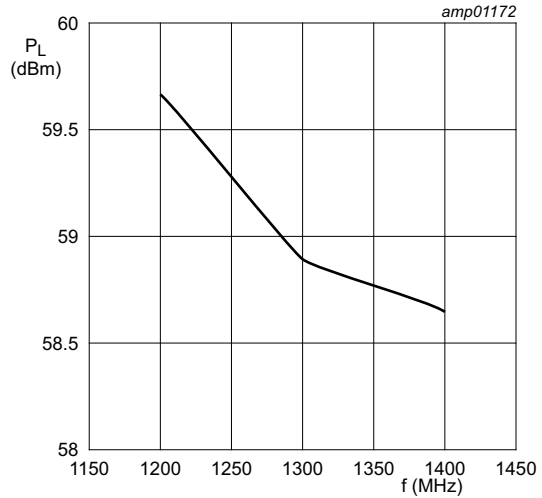

$V_{DS} = 50\text{ V}$ ;  $I_{DQ} = 500\text{ mA}$ ;  $P_i = 42.3\text{ dBm}$ ;  $t_p = 100\text{ }\mu\text{s}$ ;  $\delta = 10\text{ }\%$ .

**Fig 11. Output power as a function of frequency; typical values**



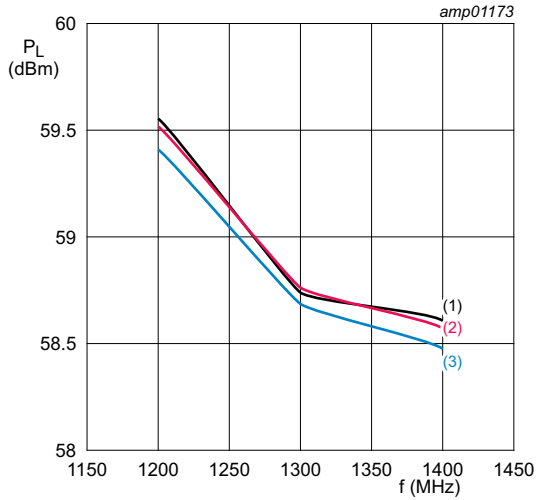

$V_{DS} = 50 \text{ V}; I_{DQ} = 500 \text{ mA}; P_i = 42.5 \text{ dBm}; \delta = 20 \text{ \%}$ .  
 (1)  $t_p = 500 \mu\text{s}$   
 (2)  $t_p = 1 \text{ ms}$   
 (3)  $t_p = 2 \text{ ms}$

**Fig 12. Output power as a function of frequency, typical values**

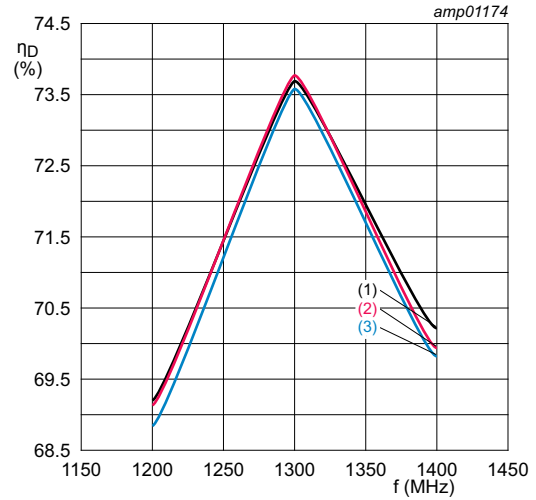

$V_{DS} = 50 \text{ V}; I_{DQ} = 500 \text{ mA}; P_i = 42.5 \text{ dBm}; \delta = 20 \text{ \%}$ .  
 (1)  $t_p = 500 \mu\text{s}$   
 (2)  $t_p = 1 \text{ ms}$   
 (3)  $t_p = 2 \text{ ms}$

**Fig 13. Drain efficiency as a function of frequency; typical values**

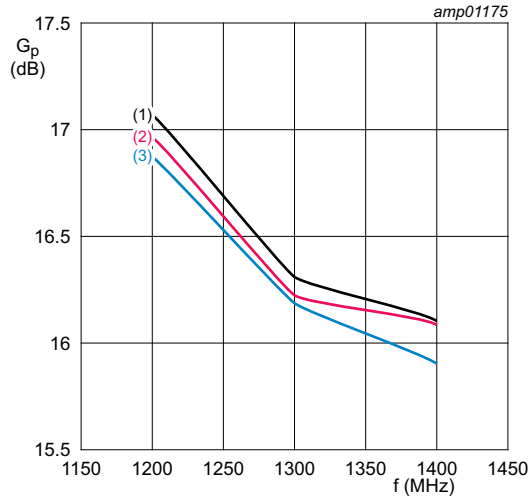

$V_{DS} = 50 \text{ V}; I_{DQ} = 500 \text{ mA}; P_i = 42.5 \text{ dBm}; \delta = 20 \text{ \%}$ .  
 (1)  $t_p = 500 \mu\text{s}$   
 (2)  $t_p = 1 \text{ ms}$   
 (3)  $t_p = 2 \text{ ms}$

**Fig 14. Power gain as a function of frequency, typical values**

8.3.2 1030 MHz demo board

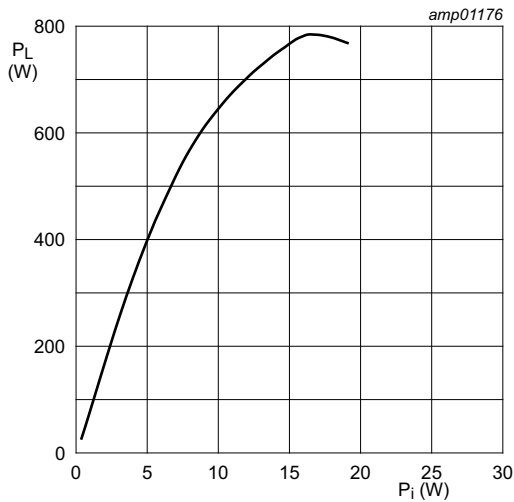

$f = 1030 \text{ MHz}; V_{DS} = 50 \text{ V}; I_{Dq} = 200 \text{ mA}; t_p = 128 \text{ }\mu\text{s}; \delta = 1 \text{ \%}.$

Fig 15. Output power as a function of input power; typical values

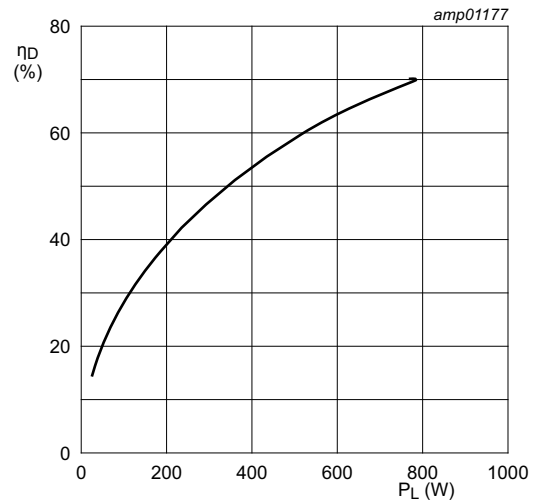

$f = 1030 \text{ MHz}; V_{DS} = 50 \text{ V}; I_{Dq} = 200 \text{ mA}; t_p = 128 \text{ }\mu\text{s}; \delta = 1 \text{ \%}.$

Fig 16. Drain efficiency as a function of output power; typical values

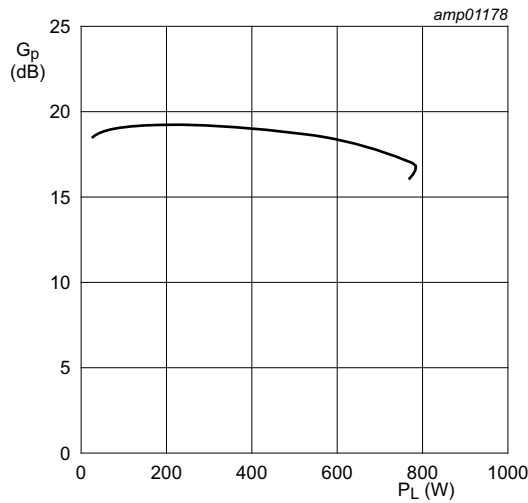

$f = 1030 \text{ MHz}; V_{DS} = 50 \text{ V}; I_{Dq} = 200 \text{ mA}; t_p = 128 \text{ }\mu\text{s}; \delta = 1 \text{ \%}.$

Fig 17. Power gain as a function of output power; typical values

8.3.3 960 MHz to 1215 MHz demo board

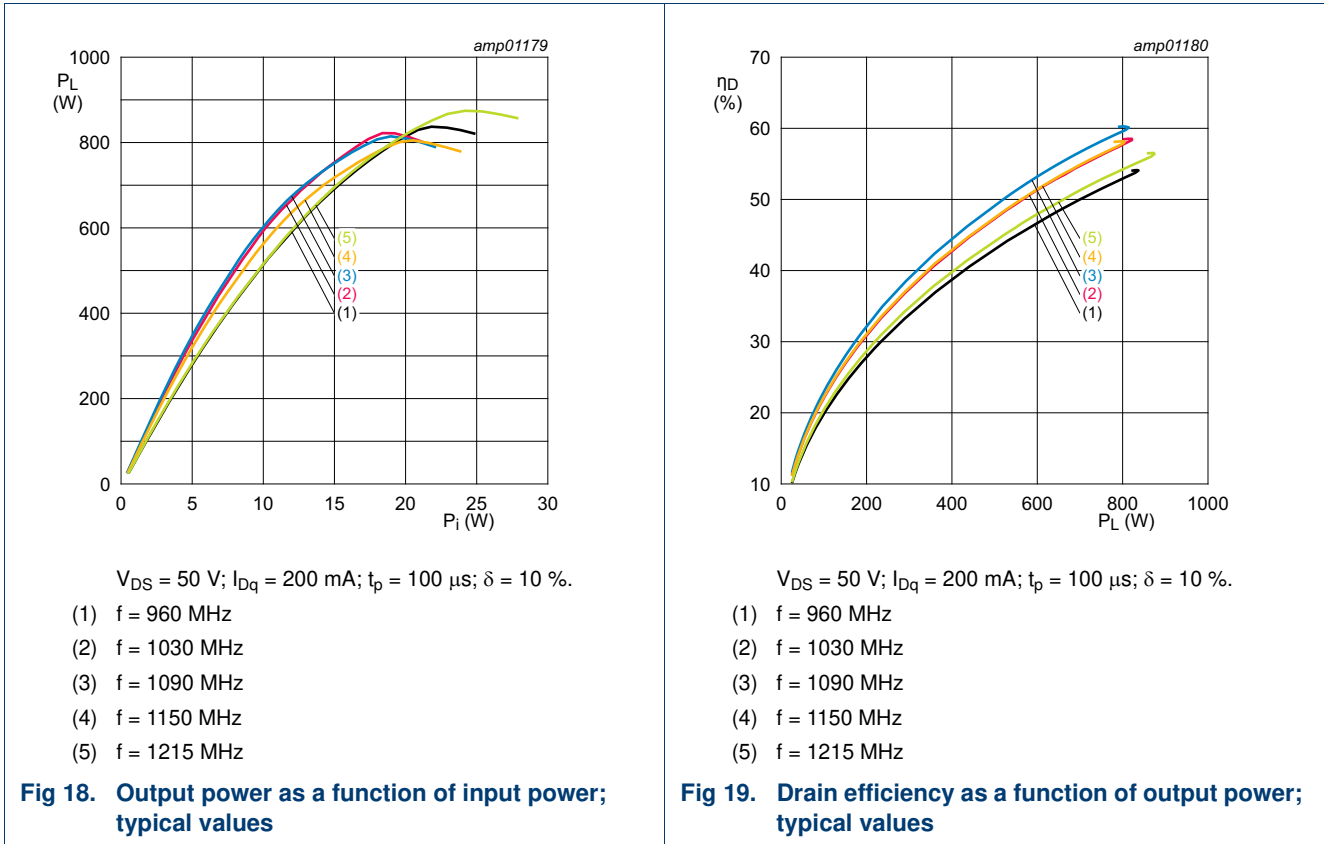

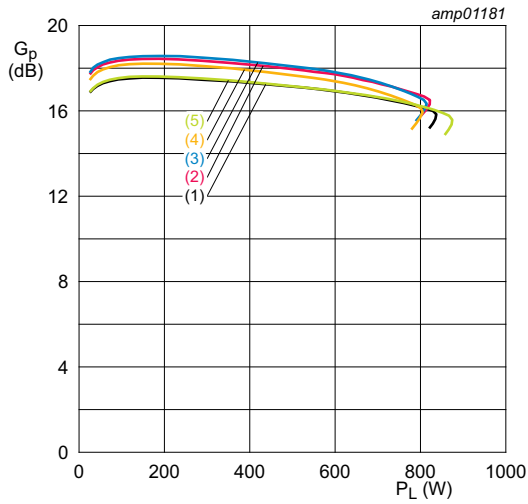

$V_{DS} = 50 \text{ V}; I_{Dq} = 200 \text{ mA}; t_p = 100 \mu\text{s}; \delta = 10 \%$ .

- (1)  $f = 960 \text{ MHz}$
- (2)  $f = 1030 \text{ MHz}$
- (3)  $f = 1090 \text{ MHz}$
- (4)  $f = 1150 \text{ MHz}$
- (5)  $f = 1215 \text{ MHz}$

**Fig 20. Power gain as a function of output power; typical values**

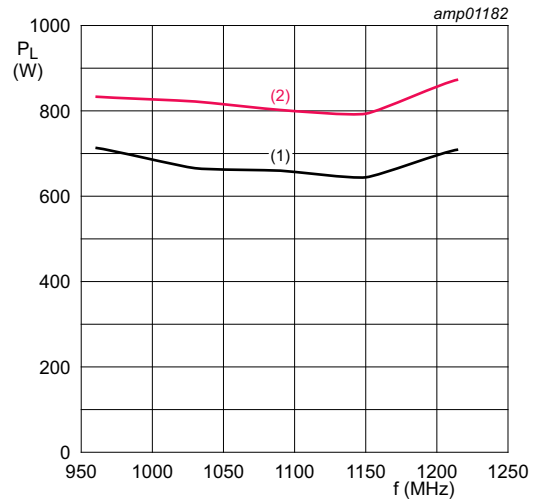

$V_{DS} = 50 \text{ V}; I_{Dq} = 200 \text{ mA}; t_p = 100 \mu\text{s}; \delta = 10 \%$ .

- (1)  $P_{L(1dB)}$
- (2)  $P_{L(2dB)}$

**Fig 21. Output power as a function of frequency; typical values**

9. Package outline

Flanged ceramic package; 2 mounting holes; 2 leads

SOT502A

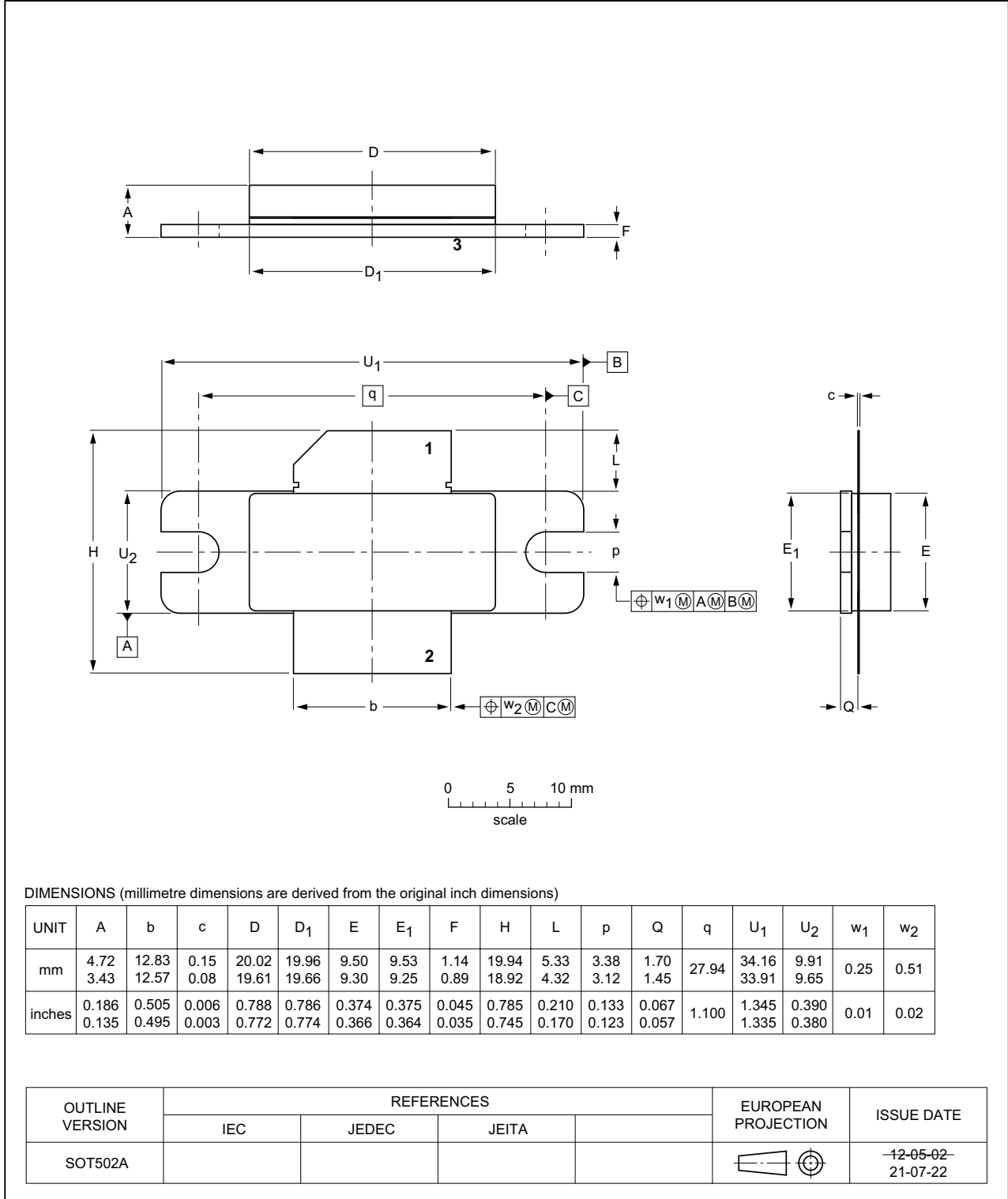

Fig 22. Package outline SOT502A

Earless flanged ceramic package; 2 leads

SOT502B

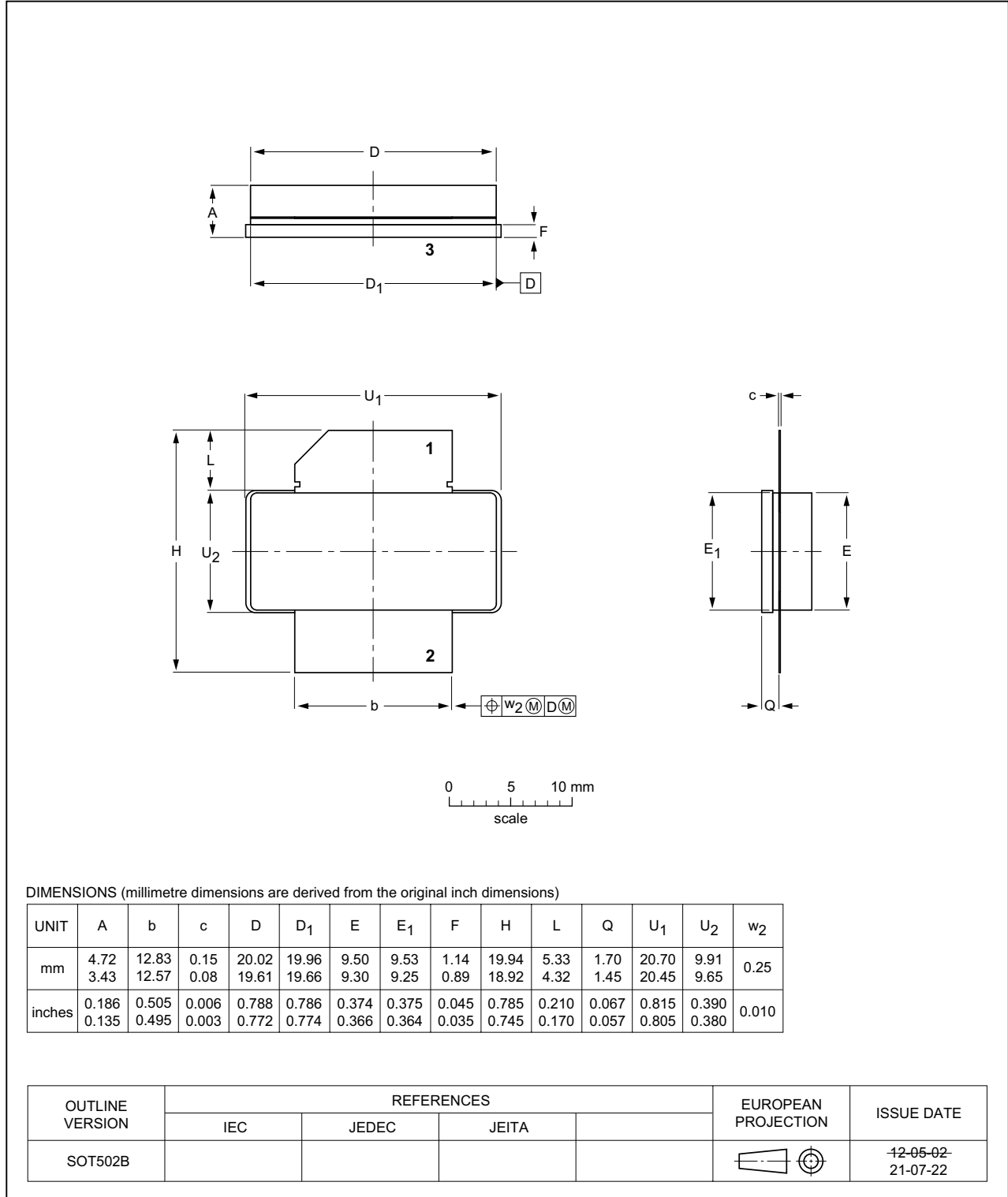

Fig 23. Package outline SOT502B

## 10. Handling information

### CAUTION



This device is sensitive to ElectroStatic Discharge (ESD). Observe precautions for handling electrostatic sensitive devices.

Such precautions are described in the *ANSI/ESD S20.20*, *IEC/ST 61340-5*, *JESD625-A* or equivalent standards.

**Table 11. ESD sensitivity**

ESD model	Class
Charged Device Model (CDM); According to ANSI/ESDA/JEDEC standard JS-002	C2B <a href="#">[1]</a>
Human Body Model (HBM); According to ANSI/ESDA/JEDEC standard JS-001	1A <a href="#">[2]</a>

[1] CDM classification C2B is granted to any part that passes after exposure to an ESD pulse of 750 V.

[2] HBM classification 1A is granted to any part that passes after exposure to an ESD pulse of 250 V.

## 11. Abbreviations

**Table 12. Abbreviations**

Acronym	Description
CW	Continuous Wave
GaN	Gallium Nitride
HEMT	High Electron Mobility Transistor
L-band	Long wave band
MTF	Median Time to Failure
SiC	Silicon Carbide
SMD	Surface Mounted Device
RoHS	Restriction of Hazardous Substances
VSWR	Voltage Standing Wave Ratio

## 12. Revision history

**Table 13. Revision history**

Document ID	Release date	Data sheet status	Change notice	Supersedes
CLL3H0914L-700_0914LS-700 v.2	20230110	Product data sheet	-	CLL3H0914L-700_0914LS-700 v.1
Modifications:	<ul style="list-style-type: none"> <li><a href="#">Table 5 on page 3</a>: table updated</li> </ul>			
CLL3H0914L-700_0914LS-700 v.1	20220715	Product data sheet	-	-

## 13. Legal information

### 13.1 Data sheet status

Document status <sup>[1][2]</sup>	Product status <sup>[3]</sup>	Definition
Objective [short] data sheet	Development	This document contains data from the objective specification for product development.
Preliminary [short] data sheet	Qualification	This document contains data from the preliminary specification.
Product [short] data sheet	Production	This document contains the product specification.

[1] Please consult the most recently issued document before initiating or completing a design.

[2] The term 'short data sheet' is explained in section "Definitions".

[3] The product status of device(s) described in this document may have changed since this document was published and may differ in case of multiple devices. The latest product status information is available on the Internet at URL <http://www.ampleon.com>.

### 13.2 Definitions

**Draft** — The document is a draft version only. The content is still under internal review and subject to formal approval, which may result in modifications or additions. Ampleon does not give any representations or warranties as to the accuracy or completeness of information included herein and shall have no liability for the consequences of use of such information.

**Short data sheet** — A short data sheet is an extract from a full data sheet with the same product type number(s) and title. A short data sheet is intended for quick reference only and should not be relied upon to contain detailed and full information. For detailed and full information see the relevant full data sheet, which is available on request via the local Ampleon sales office. In case of any inconsistency or conflict with the short data sheet, the full data sheet shall prevail.

**Product specification** — The information and data provided in a Product data sheet shall define the specification of the product as agreed between Ampleon and its customer, unless Ampleon and customer have explicitly agreed otherwise in writing. An agreement according to which the functions and qualities of Ampleon products exceed those described in the Product data sheet is invalid.

**Right to make changes** — Ampleon reserves the right to change information including but without limitation specifications and product descriptions published in this document at any time and without notice. This document supersedes and replaces all information regarding these products supplied prior to the publication hereof.

**Suitability for use** — Ampleon products are not designed, authorized or warranted to be suitable for use in life support, life-critical or safety-critical systems or equipment, nor in applications where failure or malfunction of an Ampleon product can reasonably be expected to result in personal injury, death or severe property or environmental damage. Insofar as a customer or another party nevertheless uses Ampleon products unlawfully for such purposes, Ampleon and its suppliers are not liable for any damages.

**Applications** — Applications that are described herein for any of these products are for illustrative purposes only. Ampleon makes no representation or warranty that such applications will be suitable for the specified use without further testing or modification.

Customers are responsible for the design and operation of their applications and products using Ampleon products, and Ampleon is not liable for any assistance with applications or customer product design. It is customer's sole responsibility to determine whether the Ampleon product is suitable and fit for the customer's applications and products planned, as well as for the planned application and use of customer's third party customer(s). Customers shall provide appropriate design and operating safeguards to minimize the risks associated with their applications and products.

Ampleon is not liable related to any default, damage, costs or problem which is based on any weakness or default in the customer's applications or products, or the application or use by customer's third party customer(s). Customer is responsible for and shall do all necessary testing for the customer's applications and products using Ampleon products in order to avoid a default of the applications and the products or of the application or use by customer's third party customer(s). Ampleon is not liable in this respect.

**Limiting values** — Stress above one or more limiting values (as defined in the Absolute Maximum Ratings System of IEC 60134) will cause permanent damage to the device. Limiting values are stress ratings only and (proper) operation of the device at these or any other conditions above those given in the Recommended operating conditions section (if present) or the Characteristics sections of this document is not guaranteed. Constant or repeated exposure to limiting values will permanently and irreversibly affect the quality and reliability of the device.

**Terms and conditions of commercial sale** — Ampleon products are sold subject to the general terms and conditions of commercial sale, as published at <http://www.ampleon.com/terms>, unless otherwise agreed in a valid written individual agreement. In the event of signing an individual agreement the terms and conditions of the respective agreement shall apply. Ampleon hereby expressly objects to and rejects the validity of customer's terms and conditions regarding the purchase of Ampleon products by customer.

### 13.3 Disclaimers

**Maturity** — After the relevant product(s) have passed the Release Gate in Ampleon's release process, Ampleon will confirm the final version in writing.

**Limited warranty and liability** — Ampleon uses its best efforts to keep the information in this document accurate and reliable. However, Ampleon gives no representations or warranties, expressed or implied, as to the accuracy or completeness of such information and assumes no liability for the consequences of the use of such information. Ampleon is not liable for content provided by an external information source.

In no event and irrespective of the legal basis (contract, tort (including negligence) statutory liability, misrepresentation, indemnity or any other area of law) shall Ampleon be liable for any indirect, incidental, punitive, special or consequential damages (including but without limitation loss of profit or revenue, loss of use or loss of production, loss of data, cost of capital, cost of substitute goods, property damage external to the Ampleon products and any damage, expenditure or loss arising out of such damage, business interruption, costs related to the removal or replacement of any products or rework charges) or any of the foregoing suffered by any third party.

Notwithstanding any damages that customer might incur for any reason whatsoever, Ampleon's aggregate and cumulative liability towards customer for the products described herein shall be limited in accordance with the *Terms and conditions of commercial sale* of Ampleon.



**No offer to sell or license** — Nothing in this document may be interpreted or construed as an offer to sell products that is open for acceptance or the grant, conveyance or implication of any license under any copyrights, patents or other industrial or intellectual property rights.

**Export control** — This document as well as the item(s) described herein may be subject to export control regulations. Export might require a prior authorization from competent authorities.

**Non-automotive qualified products** — Unless this data sheet expressly states that this specific Ampleon product is automotive qualified, the product is not suitable for automotive use. It is neither qualified nor tested in accordance with automotive testing or application requirements. Ampleon is not liable for inclusion and/or use of non-automotive qualified products in automotive equipment or applications.

In the event that customer breaches this and uses the products for design and use in automotive applications in accordance with automotive specifications and standards, (a) Ampleon gives no warranty, representation

or other guarantees of any kind with respect to such automotive applications, use and specifications, and (b) such use is solely and exclusively at customer's own risk, and (c) customer fully indemnifies Ampleon against any and all liability, damages or failed product claims, including against third parties, arising out of customer's design and use of the product for automotive applications.

**Translations** — A non-English (translated) version of a document is for reference only. The English version shall prevail in case of any discrepancy between the translated and English versions.

## 13.4 Trademarks

Notice: All referenced brands, product names, service names and trademarks are the property of their respective owners.

## 14. Contact information

---

For more information, please visit: <http://www.ampleon.com>

For sales office addresses, please visit: <http://www.ampleon.com/sales>

15. Contents

1 **Product profile** . . . . . 1

1.1 General description . . . . . 1

1.2 Features and benefits . . . . . 1

2 **Pinning information** . . . . . 2

3 **Ordering information** . . . . . 2

4 **Limiting values** . . . . . 2

5 **Thermal characteristics** . . . . . 3

6 **Characteristics** . . . . . 3

7 **Application information** . . . . . 4

7.1 Circuit information . . . . . 4

7.2 Impedance information . . . . . 5

8 **Test information** . . . . . 5

8.1 Ruggedness in class-AB operation . . . . . 5

8.2 Test circuit information . . . . . 6

8.3 Graphical data . . . . . 7

8.3.1 1200 MHz to 1400 MHz demo board . . . . . 7

8.3.2 1030 MHz demo board . . . . . 10

8.3.3 960 MHz to 1215 MHz demo board . . . . . 11

9 **Package outline** . . . . . 13

10 **Handling information** . . . . . 15

11 **Abbreviations** . . . . . 15

12 **Revision history** . . . . . 15

13 **Legal information** . . . . . 16

13.1 Data sheet status . . . . . 16

13.2 Definitions . . . . . 16

13.3 Disclaimers . . . . . 16

13.4 Trademarks . . . . . 17

14 **Contact information** . . . . . 17

15 **Contents** . . . . . 18

Please be aware that important notices concerning this document and the product(s) described herein, have been included in section 'Legal information'.

© Ampleon Netherlands B.V. 2023. All rights reserved.

For more information, please visit: <http://www.ampleon.com>  
 For sales office addresses, please visit: <http://www.ampleon.com/sales>

Date of release: 10 January 2023

Document identifier: CLL3H0914L-700\_0914LS-700