

TOSHIBA CMOS Integrated Circuit Silicon Monolithic

TC78B015AFTG

3-phase Driver for Brushless DC Motors

The TC78B015AFTG is for three-phase full-wave brushless DC motor with 150-degree trapezoid PWM chopper system. They control motor rotational speed by changing the PWM duty, based on the speed control input. Hall signal is supported to one sensor for the TC78B015AFTG.

Features

- Three-phase full wave drive
- 150-degree trapezoid PWM chopper system
- Soft switching
- Hall amplifier (hall element / hall IC):
 - 1-sensor drive
- Power supply: absolute maximum voltage: 36 V
- Output current: absolute maximum current: 3 A
- Selectable rotational speed command input signal:
 - Pulse duty signal input/analog voltage input/PWM signal input
- Selectable PWM frequency
- Adjustable minimum duty in PWM control
- Adjustable speed ratio in PWM control
- Selectable lead angle control function: Auto lead angle function/External lead angle control (32 steps correspond to 0 to 58°)
- Selectable rotation direction
- Brake function terminal
- Selectable lock detection function
- Restart function
- Rotation frequency signal (FG_OUT):
 - 1 pulse/ electrical angle 360°, 2/3 pulse/ electrical angle 360°, 1/2 pulse/ electrical angle 360°, 1/3 pulse/ electrical angle 360°
- Lock detection signal (LD_OUT)
- Power supply voltage monitoring function
- Overcurrent detection circuit (ISD)
- Thermal shutdown circuit (TSD)
- Under voltage lockout circuit (UVLO)
- Current limit circuit
- Adjustable start conditions
- Selectable control function of forced commutation frequency (1-sensor drive).

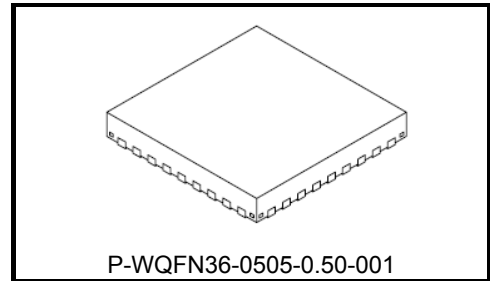

P-WQFN36-0505-0.50-001

Weight: 0.06 g (typ.)

Pin assignment

<Top view>

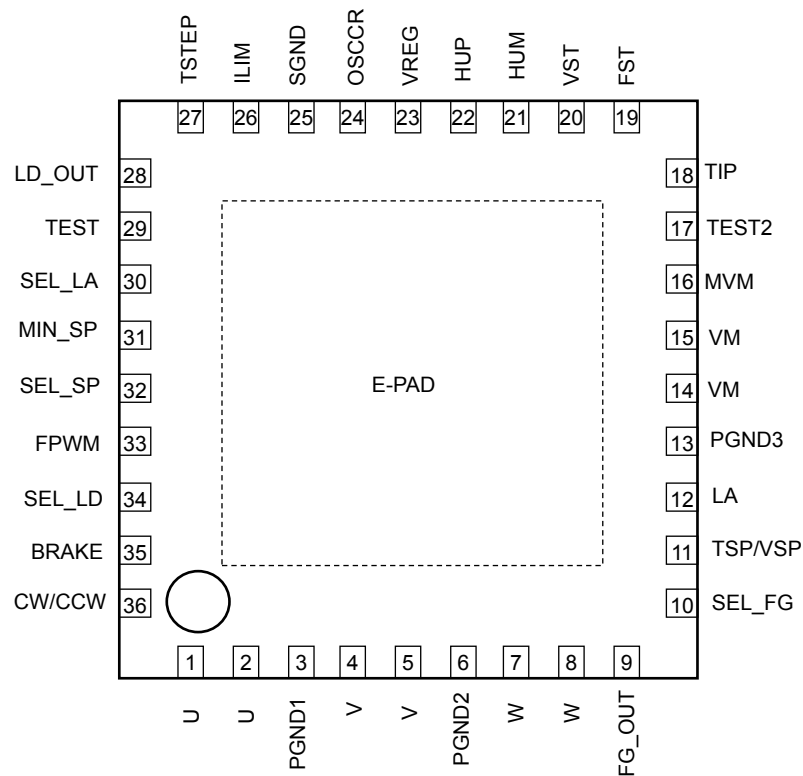

Note 1: Design the pattern in consideration of the heat design because the back side (E-PAD) has the role of heat radiation. The back side (E-PAD) should be connected to GND because it is connected to the back of the chip electrically.

Note 2: There are four pairs of terminals named U, V, W, and VM. Connect two each of the terminals which has the same pin symbol via external patterns. Regarding GND, connect PGND1, PGND2, PGND3, and SGND via external patterns. PGND1 and PGND2 are short-circuited in the IC.

Pin description

Pin No.	Symbol	I/O	Description
1	U	O	Output terminal for U phase
2	U	O	Output terminal for U phase
3	PGND1	—	Power ground terminal (source of output Nch MOS transistor)
4	V	O	Output terminal for V phase
5	V	O	Output terminal for V phase
6	PGND2	—	Power ground terminal (source of output Nch MOS transistor)
7	W	O	Output terminal for W phase
8	W	O	Output terminal for W phase
9	FG_OUT	O	Output terminal for rotation frequency
10	SEL_FG	I	Selectable terminal for FG frequency division ratio
11	TSP/VSP	I	Input terminal for rotational speed command
12	LA	I	Input terminal for setting lead angle
13	PGND3	—	Power ground terminal (GND for pre-driver block)
14	VM	—	Power supply terminal for motor
15	VM	—	Power supply terminal for motor
16	MVM	I	Terminal for monitoring power supply
17	TEST2	—	Terminal for test
18	TIP	I	Capacitor connecting terminal for setting DC excitation time
19	FST	I	Selectable terminal for forced commutation frequency
20	VST	I	Terminal for setting PWM ON duty of DC excitation and forced commutation mode
21	HUM	I	U-phase Hall-signal input (-)
22	HUP	I	U-phase Hall-signal input (+)
23	VREG	—	Output terminal for reference voltage (5 V)
24	OSCCR	—	Terminal for setting internal oscillator circuit
25	SGND	—	Signal ground terminal
26	ILIM	I	Terminal for setting current limit
27	TSTEP	—	Terminal for setting acceleration and deceleration time of PWM duty
28	LD_OUT	O	Output terminal for lock detection
29	TEST	I	Terminal for test
30	SEL_LA	I	Input terminal for selecting a method of lead angle or external input
31	MIN_SP	I	Input terminal for setting minimum output on duty
32	SEL_SP	I	Input terminal for selecting a method of rotational speed command
33	FPWM	I	Input terminal for selecting PWM frequency
34	SEL_LD	I	Selectable terminal for motor lock detection function
35	BRAKE	I	Brake on/off terminal
36	CW/CCW	I	Input terminal for selecting rotation direction

I/O Equivalent circuits

The equivalent circuit diagrams may be simplified or some parts of them may be omitted for explanatory purposes.

Pin symbol	I/O Signal	I/O Internal Circuit
HUP HUM	Input terminal Hysteresis ± 8 mV (typ.)	
CW/CCW BRAKE	Input terminal H: 2 V (min) L: 0.8 V (max)	
FST SEL_SP SEL_LA	Input terminal When leaving the terminal open, it is set to Middle level. When leaving the terminal open, plenty of evaluations using actual systems are required before using.	
SEL_FG MIN_SP LA FPWM SEL_LD	Input terminal Applying a voltage to the terminals is required.	
VST	Terminal for setting ON duty from DC excitation mode to forced commutation mode	

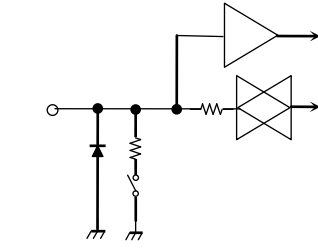
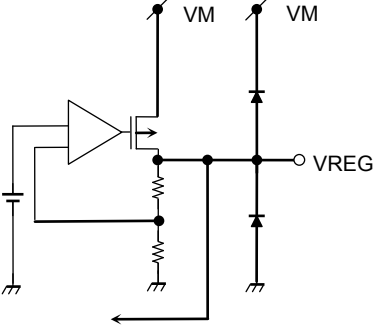
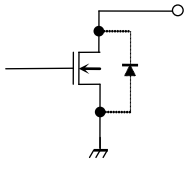
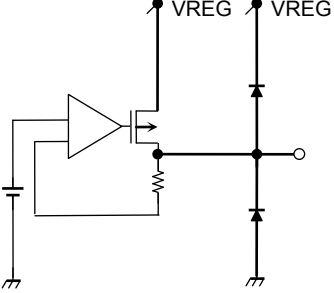
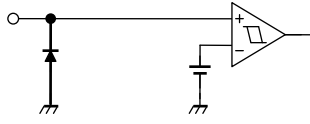
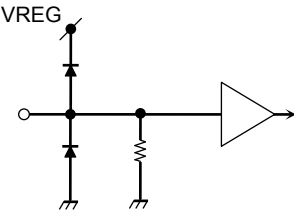
Pin symbol	I/O Signal	I/O Internal Circuit
TSP/VSP	Input terminal for rotational speed command	
VREG	Output terminal for reference voltage VREG = 5 V (typ.) Connect a capacitor (Recommended value: 0.1 μF) for voltage stability between SGND.	
FG_OUT LD_OUT	Open drain output Pull-up the terminals externally to output high level.	
ILIM	Terminal for setting current limit Connect the resistance between SGND	
MVM	Input terminal for monitoring power supply voltage Applying a voltage to the terminals is required.	
TEST	Test terminal	

Pin symbol	I/O Signal	I/O Internal Circuit
<p>TIP TSTEP</p>	<p>Terminal for setting time</p> <p>Connect a capacitor to SGND.</p>	
<p>OSCCR</p>	<p>Terminal for setting internal oscillation frequency</p> <p>Connect 27 kΩ to VREG and 360 pF to SGND.</p>	
<p>VM U V W</p>	<p>Output terminals for U, V, and W phases</p> <p>VM: Power supply terminal for motor</p>	

Absolute Maximum Ratings (Ta = 25°C)

Characteristics	Symbol	Rating	Unit
Power supply voltage	VM	36	V
Input voltage	V _{IN1} (Note 1)	-0.3 to 6	V
	V _{IN2} (Note 2)	-0.3 to V _{REG} + 0.3	V
Output voltage	V _{OUT1} (Note 3)	36	V
	V _{OUT2} (Note 4)	36	
Output current	I _{OUT1} (Note 5)	3 (Note 8)	A
	I _{OUT2} (Note 6)	10	mA
	I _{OUT3} (Note 7)	40	mA
Power dissipation	P _D	4.1 (Note 9)	W
Operating temperature	T _{opr}	-40 to 85	°C
Storage temperature	T _{stg}	-55 to 150	°C

Note: The absolute maximum ratings of a semiconductor device are a set of ratings that must not be exceeded, even for a moment. Do not exceed any of these ratings. Exceeding the ratings may cause the device breakdown, damage or deterioration, and may result injury by explosion or combustion. Please use within the specified operating ranges.

Note 1: Terminal for V_{IN1}: TSP/VSP, CW/CCW, and BRAKE

Note 2: Terminal for V_{IN2}: HUP, HUM, SEL_LD, SEL_FG, CW/CCW, BRAKE, ILIM, MIN_SP, MVM, SEL_SP, LA, FPWM, SEL_LA, and TEST

Note 3: Terminal for V_{OUT1}: U, V, and W

Note 4: Terminal for V_{OUT2}: FG_OUT and LD_OUT

Note 5: Terminal for I_{OUT1}: U, V, and W

Note 6: Terminal for I_{OUT2}: FG_OUT and LD_OUT

Note 7: Terminal for I_{OUT3}: VREG

Note 8: Output current may be limited by the ambient temperature or the device implementation. The maximum junction temperature should not exceed T_j (max) = 150°C.

Note 9: When mounted on a board (4 layers, FR4, 76.2 mm × 114.3 mm × 1.6 mm), R_{th} (j-a) = 30.5°C/W

Operating ranges

Characteristics	Symbol	Operating range	Unit
Power supply voltage	V_{Mopr}	6 to 30 V	V

Power dissipation (reference data)

When mounted on a board (4 layers, FR4, 76.2 mm × 114.3 mm × 1.6 mm), $R_{th(j-a)} = 30.5^{\circ}\text{C/W}$

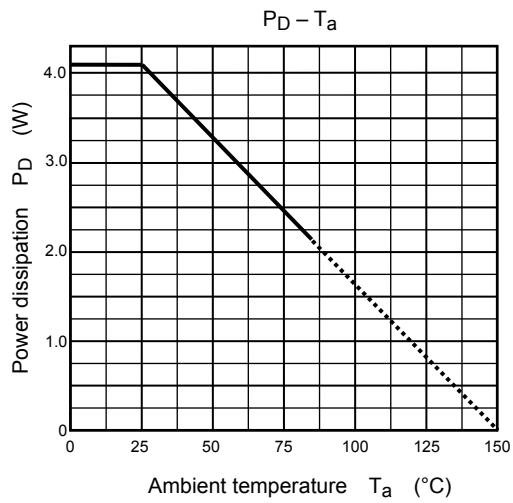

Electrical Characteristics (Ta = 25°C)

Characteristics		Symbol	Test Conditions	Min	Typ.	Max	Unit	
Power supply current		IM	IVreg = 0 mA	—	6.0	8.5	mA	
Input current		IIN1A	TSP/VSP (SEL_SP = VREG)	-1	—	1	μA	
		IIN1D(H)	TSP/VSP = 5 V (SEL_SP = Open, GND)	—	100	150		
		IIN1D(L)	TSP/VSP = 0 V (SEL_SP = Open, GND)	-1	—	1		
		IIN2	SEL_FG, MIN_SP, LA, FPWM, SEL_LD	-1	—	1		
		IN3(H)	VIN = 5 V FST, SEL_SP, LA, SEL_LA	—	100	150		
		IN3(L)	VIN = 0 V FST, SEL_SP, LA, SEL_LA	-150	-100	—		
		IN4(H)	VIN = 5 V CW/CCW, BRAKE	—	100	150		
		IN4(L)	VIN = 0 V CW/CCW, BRAKE	-1	0	—		
	IN5	MVM	-1	—	1			
Hall element input	Input sensitivity	VS	Differential input	40	—	—	mVpp	
	In-phase voltage range	VW	—	0.5	—	3.5	V	
	Input hysteresis	VH	(Reference data)	±4	±8	±12	mV	
Hall IC input		VIN4	H	HUP	VREG -1	—	VREG	V
			L	HUM = VREG/2	0	—	0.8	
Input voltage		VIN1 (H)	TSP/VSP	2.0	—	5.5	V	
		VIN1 (L)	SEL_SP = Open, GND	GND	—	0.8		
		VIN2 (H)	CW/CCW, BRAKE	2.0	—	5.5		
		VIN2 (L)	CW/CCW, BRAKE	GND	—	0.8		
		VIN3 (H)	MVM L→H: 150-degree commutation →120-degree commutation	1.9	2.0	2.1		
		VIN3 (L)	MVM H→L: 120-degree commutation→150-degree commutation	1.7	1.8	1.9		
Input hysteresis range		V1hys	(Reference data) TSP/VSP SEL_SP = GND	0.3	0.4	0.5	V	
		V2hys	(Reference data) CW/CCW, BRAKE	0.3	0.4	0.5		
Output low voltage of FG_OUT/LD_OUT		VOOUT	IOOUT = 5 mA	GND	—	0.5	V	
Leakage current of FG_OUT/LD_OUT		ILOUT	VOOUT = 30 V	—	0	2	μA	
Output on resistance of U, V, W		RON (H+L)	IOOUT = 1 A	—	0.24	0.33	Ω	
Output leakage current of U, V, W		IL (H)	VOOUT = 0 V	-10	0	—	μA	
		IL (L)	VOOUT = 30 V	—	0	10		
ON resistance of VST terminal in starting		RVST	—	—	600	1000	Ω	

Characteristics	Symbol	Test Conditions	Min	Typ.	Max	Unit
Masking time for detecting current limit	TRS	(Reference data)	—	1.2	—	μs
Detection error of current limit	ΔIOUT	Iout (U/V/W) = 1 A, ILIM: 39 kΩ	-10	—	10	%
Relative detection error of current limit	ΔIOUT_R	(Reference data) Iout (U/V/W) = 1 A, ILIM: 39 kΩ Measured value of each upper-and-lower phase for average value of upper-and-lower phase	-8.5	—	8.5	%
PWM oscillation frequency	FPWM3	(Reference data)FPWM = "3"	22.5	25	27.5	kHz
	FPWM2	(Reference data)FPWM = "2"	180	200	220	
	FPWM1	(Reference data)FPWM = "1"	90	100	110	
	FPWM0	(Reference data)FPWM = "0"	45	50	55	
OSC frequency	OSC	(Reference data)OSCCR: 27 kΩ,360 pF	11.7	13	14.3	MHz
Setting time of TSTEP terminal	Tsoft	(Reference data)TSTEP = 0.01 μF	—	0.100	—	s
Setting time of TIP terminal	Tip	(Reference data)TIP = 0.01 μF	—	0.100	—	s
Lock detection time	Tlock1	(Reference data)SEL_LD = "0"	—	0.5	—	s
Restart time after lock	Tlock2	(Reference data)SEL_LD = "0"	—	5	—	s
Masking time for detecting overcurrent	TISD	(Reference data)	—	1.9	—	μs
Current when overcurrent detection operates	ISD	(Reference data)	3	4.5	6	A
Thermal shutdown circuit	TSD	(Reference data)	150	165	180	°C
	TSDhys	(Reference data) Hysteresis for restart	—	15	—	
Under lockout voltage of VM terminal	VMUVLO	—	5.0	5.3	5.6	V
Under lockout restarting voltage of VM terminal	VMUVLOR	—	5.3	5.6	5.9	V
VREG output voltage	VREG	IVREG = -40 mA (Note 1)	4.7	5	5.3	V

(Reference data): No shipping inspection

Note 1: There is a possibility that VREG output voltage does not reach the minimum value in the above Electrical Characteristics when the power supply voltage is less than the operating ranges. Moreover, it depends on VM and the conditions of IVREG. Therefore, confirm there are not any problems by evaluating actual systems at about VMUVLO.

The relation of setting steps and terminal voltage

SEL_SP FST SEL_LA	SEL_FG FPWM SEL_LD	MIN_SP	LA (Auto lead angle: SEL_LA = "1")	LA (External input: SEL_LA = "0")	Input voltage (V) (Written by VREG)		Input voltage (V) (When VREG = 5 V)			
					Min	Max	Min	Max		
2	3	8	7	31	Vreg/256*160	Vreg	3.125	5		
				30	Vreg/256*155	Vreg/256*159	3.027	3.105		
				29	Vreg/256*150	Vreg/256*154	2.93	3.008		
1	2	7	6	28	Vreg/256*145	Vreg/256*149	2.832	2.910		
				27	Vreg/256*140	Vreg/256*144	2.734	2.813		
				26	Vreg/256*135	Vreg/256*139	2.637	2.715		
				25	Vreg/256*130	Vreg/256*134	2.539	2.617		
				24	Vreg/256*125	Vreg/256*129	2.441	2.520		
				23	Vreg/256*120	Vreg/256*124	2.344	2.422		
		6	5	22	Vreg/256*115	Vreg/256*119	2.246	2.324		
				21	Vreg/256*110	Vreg/256*114	2.148	2.227		
				20	Vreg/256*105	Vreg/256*109	2.051	2.129		
				19	Vreg/256*100	Vreg/256*104	1.953	2.031		
				18	Vreg/256*95	Vreg/256*99	1.855	1.934		
				17	Vreg/256*90	Vreg/256*94	1.758	1.836		
	1	4	4	4	16	Vreg/256*85	Vreg/256*89	1.66	1.738	
					15	Vreg/256*80	Vreg/256*84	1.563	1.641	
					14	Vreg/256*75	Vreg/256*79	1.465	1.543	
					13	Vreg/256*70	Vreg/256*74	1.367	1.445	
					12	Vreg/256*65	Vreg/256*69	1.27	1.348	
					11	Vreg/256*60	Vreg/256*64	1.172	1.250	
		3	3	3	3	10	Vreg/256*55	Vreg/256*59	1.074	1.152
						9	Vreg/256*50	Vreg/256*54	0.977	1.055
						8	Vreg/256*45	Vreg/256*49	0.879	0.957
						7	Vreg/256*40	Vreg/256*44	0.781	0.859
						6	Vreg/256*35	Vreg/256*39	0.684	0.762
						5	Vreg/256*30	Vreg/256*34	0.586	0.664
0	0	1	1	4	Vreg/256*25	Vreg/256*29	0.488	0.566		
				3	Vreg/256*20	Vreg/256*24	0.391	0.469		
				2	Vreg/256*15	Vreg/256*19	0.293	0.371		
				1	Vreg/256*10	Vreg/256*14	0.195	0.273		
	0	0	0	0	0	0	Vreg/256*9	0	0.176	

Functional Description

The equivalent circuit diagrams may be simplified or some parts of them may be omitted for explanatory purposes. Timing charts may be simplified for explanatory purposes.

1. Basic operation

In receiving the start command, rotational speed and rotation direction are detected and the motor operates by the sequence of the following table.

Detection of rotation direction	State	Sequence of operation
Enable	Rotation direction agrees	150-degree PWM drive
	Rotation direction disagrees	Reverse brake → Forced commutation → 150-degree PWM drive
Disenable	Position signal frequency ≤ 40 Hz	DC excitation → Forced commutation → 150-degree PWM drive
	Position signal frequency: 40 to 200 Hz	Short brake → DC excitation → Forced commutation → 150-degree PWM drive
	Position signal frequency > 200 Hz	Detecting rotation direction is retried.

2. Startup operation

Term of the DC excitation is configured by the TIP terminal. Forced commutation frequency is configured by the FST terminal. When the frequency of a position signal exceeds the frequency configured by the FST terminal, the operation moves from the forced commutation mode to the 150-degree PWM drive. In outputting, the on-duty in the DC excitation mode and the forced commutation mode correspond to the duty according to VST terminal voltage. The on-duty in the 150-degree PWM drive is determined by the input of TSP/VSP terminals. And startup, speed variable, and stop of the motor are controlled.

Time configuration and starting torque (output duty) of DC excitation and forced commutation are changed depending on motors and loads. So, adjustment is needed by experiment.

1) DC excitation mode

Term of the DC excitation is configured by the TIP terminal. The motor operates in the DC excitation mode for $2 \times T2[s]$. The operation shifts to the DC excitation (2) after $T2$ term of the DC excitation (1). And it shifts to the forced commutation after $T2$ term of the DC excitation (2).

In the term of the DC excitation (1) and (2), when C_2 is $0.01 \mu F$, $T2$ is calculated as follows:

$$32 \times 0.313 \times C_2 \times 10^6 = \text{approximately } 0.100 \text{ s}$$

States of the excitation phase of the DC excitation (1) and (2) according to the state of CW/CCW and the signals of HUP and HUM terminals are shown in the following table.

When CW/CCW = L, HU (HUP-HUM) = H

Mode	DC excitation (1)	DC excitation (2)
Term[s]	T2	T2
Conduction phase	U phase: Full ON (Lower side) V phase: OFF W phase: PWM (Upper side)	U phase: OFF V phase: PWM (Lower side) W phase: Full ON (Upper side)

When CW/CCW = L, HU (HUP-HUM) = L

Mode	DC excitation (1)	DC excitation (2)
Term[s]	T2	T2
Conduction phase	U phase: Full ON (Upper side) V phase: OFF W phase: PWM (Lower side)	U phase: OFF V phase: PWM (Upper side) W phase: Full ON (Lower side)

When CW/CCW=H, HU (HUP-HUM) = H

Mode	DC excitation (1)	DC excitation (2)
Term[s]	T2	T2
Conduction phase	U phase: PWM (Upper side) V phase: OFF W phase: Full ON (Lower side)	U phase: Full ON (Upper side) V phase: PWM (Lower side) W phase: OFF

When CW/CCW = H, HU (HUP-HUM) = L

Mode	DC excitation (1)	DC excitation (2)
Term[s]	T2	T2
Conduction phase	U phase: PWM (Lower side) V phase: OFF W phase: Full ON (Upper side)	U phase: Full ON (Lower side) V phase: PWM (Upper side) W phase: OFF

2) Forced commutation mode

Forced commutation frequency is determined by the FST terminal.

Number of steps set of FST terminal	Forced commutation frequency
2	Forced commutation frequency $f_{ST} \approx 1.6 \text{ Hz}$
1	Forced commutation frequency $f_{ST} \approx 6.4 \text{ Hz}$
0	Forced commutation frequency $f_{ST} \approx 3.2 \text{ Hz}$

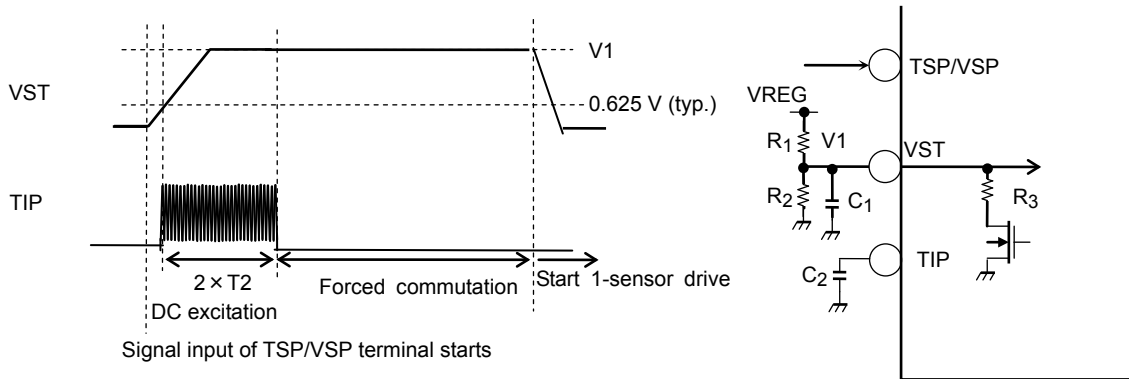

VST voltage is calculated from the following formula. (t = 0 s in startup)

$$VST(t) = V1 \times (1 - e^{-t/\tau})$$

$$V1 = R_2 / (R_1 + R_2) \times VREG \quad (VREG = 5 \text{ V (typ.)})$$

$$\tau = (R_1 \times R_2) / (R_1 + R_2) \times C_1$$

3) Timing chart in starting

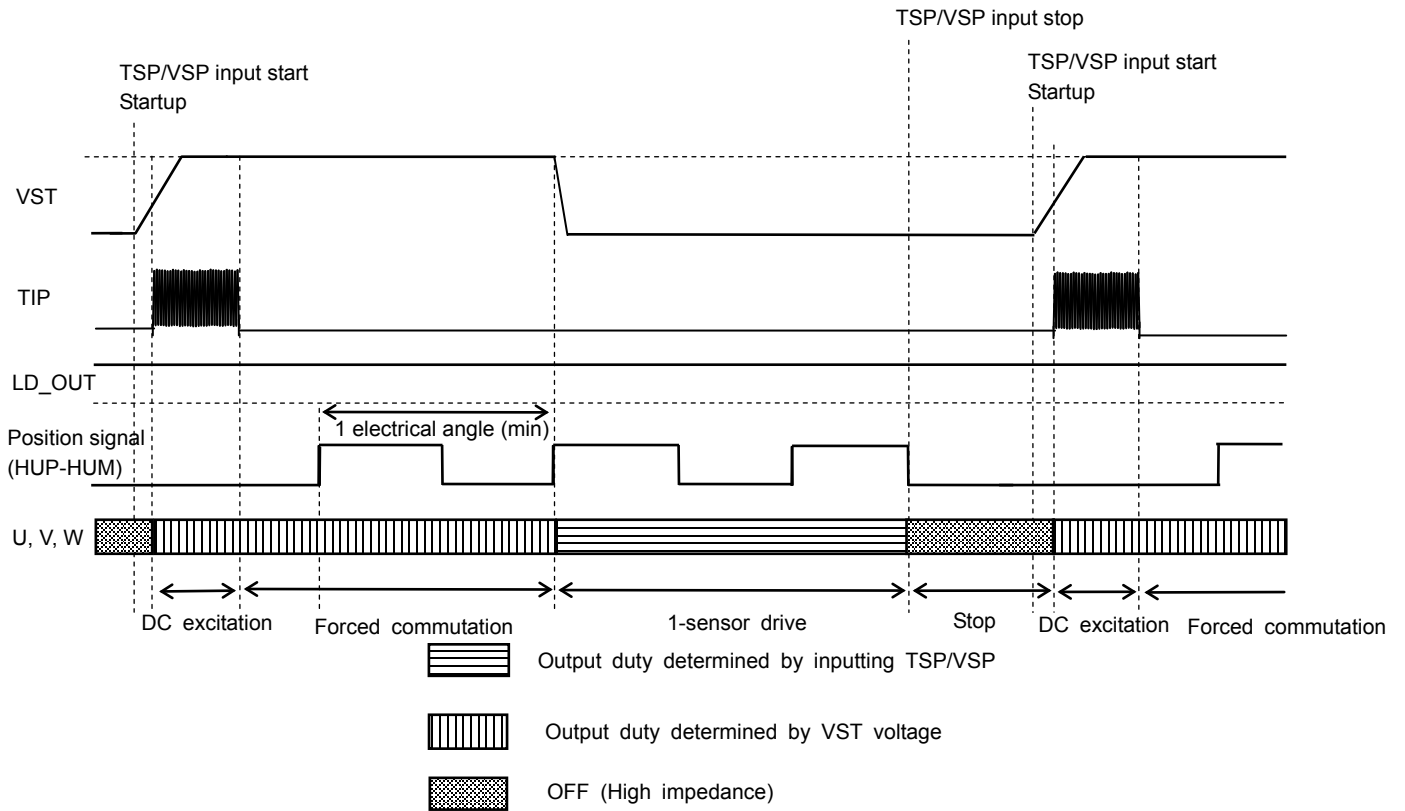

3. Position detection terminal

<Hall element input>

In-phase voltage range: $V_W = 0.5$ to 3.5 V
 Input hysteresis: $V_H = 8$ mV (typ.)

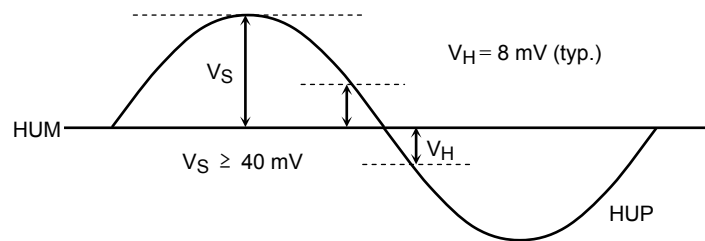

<Hall IC input>

Conditions: HUP = GND to VREG
 HUM = VREG/2

4. Operation in abnormality detection

The following states are detected as abnormalities:

1. The ISD circuit is activated.
2. The TSD circuit is activated.
3. The motor lockout detection is activated.
4. Overvoltage detection is activated.
5. Frequency of position signal is abnormal (≥ 3 kHz per electrical angle)

If either of the above abnormality of 1, 2, 3 or 5 is detected, the LD_OUT terminal outputs low level until 150-degree PWM drive starts.

<Output operation of U, V, W, and LD_OUT terminals in abnormality detection>

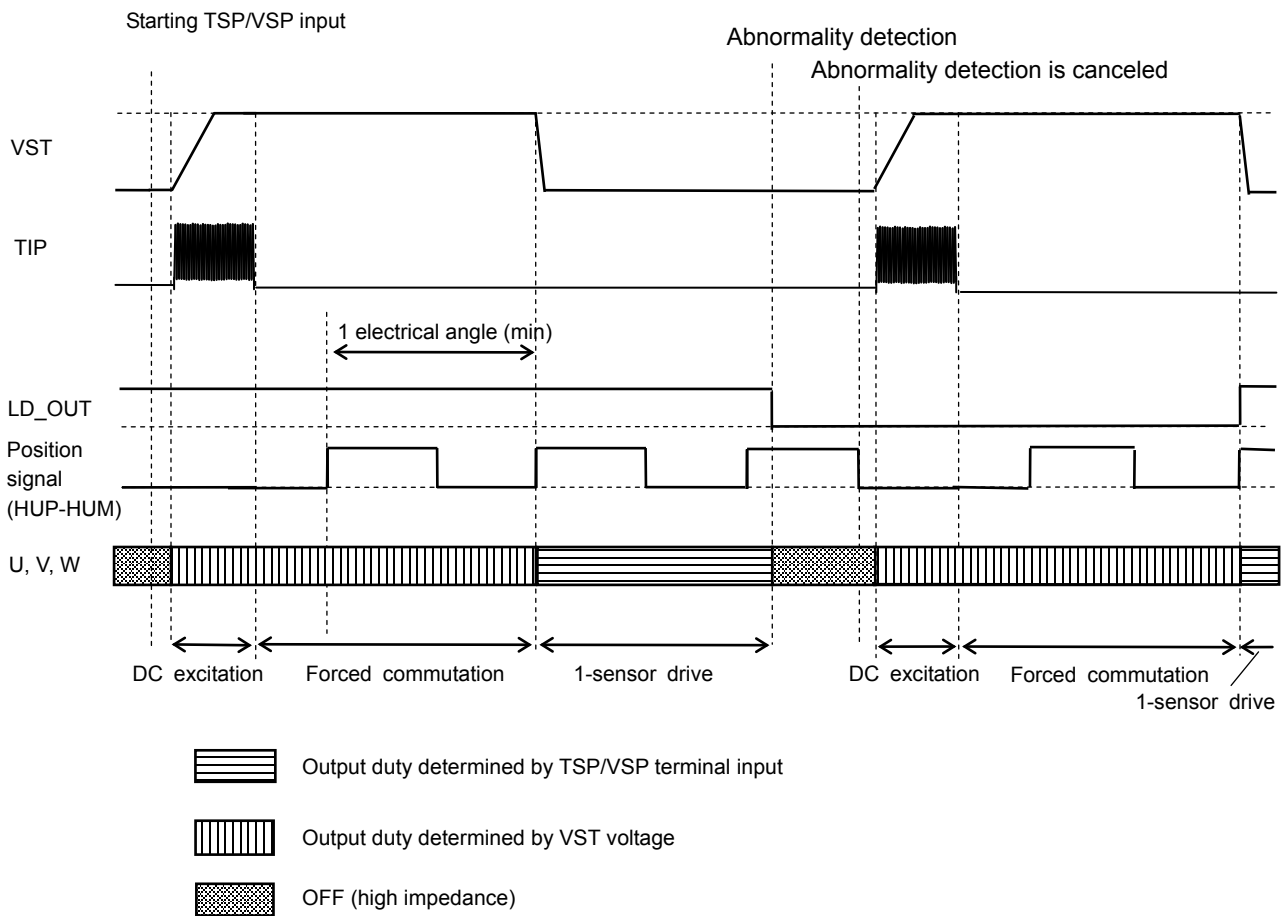

5. Motor lockout detection

If the position signal does not change within the term of Ton, which is configured by SEL_LD terminal, during the forced commutation mode or 150-degree PWM drive, the operation turns off, and re-starts after the term of Toff. After abnormality is detected, LD_OUT terminal outputs low. It outputs high when the operation moves to the 150-degree PWM drive. When on duty = 0 % as a rotational speed command is input into TSP/VSP terminal, the term of Toff is released. After a start command signal is input into TSP/VSP terminal, the drive will restart.

To release the abnormality detection, input a rotational speed command of 'on duty = 0 % ' for 2 ms period or more.

Ton and Toff are set by SEL_LD terminal as follows.

Number of steps set of SEL_LD terminal	Functional description
3	Motor lockout detection does not work. Also disable for abnormality detection when the frequency of position signal is abnormal (≥ 3 kHz/electrical angle)
2	Ton = 1 s (typ.), Toff = 10 s (typ.)
1	Ton = 0.5 s (typ.), Toff = 10 s (typ.)
0	Ton = 0.5 s (typ.), Toff = 5 s (typ.)

<Output operation of U, V, W, and LD_OUT terminals in lockout detection>

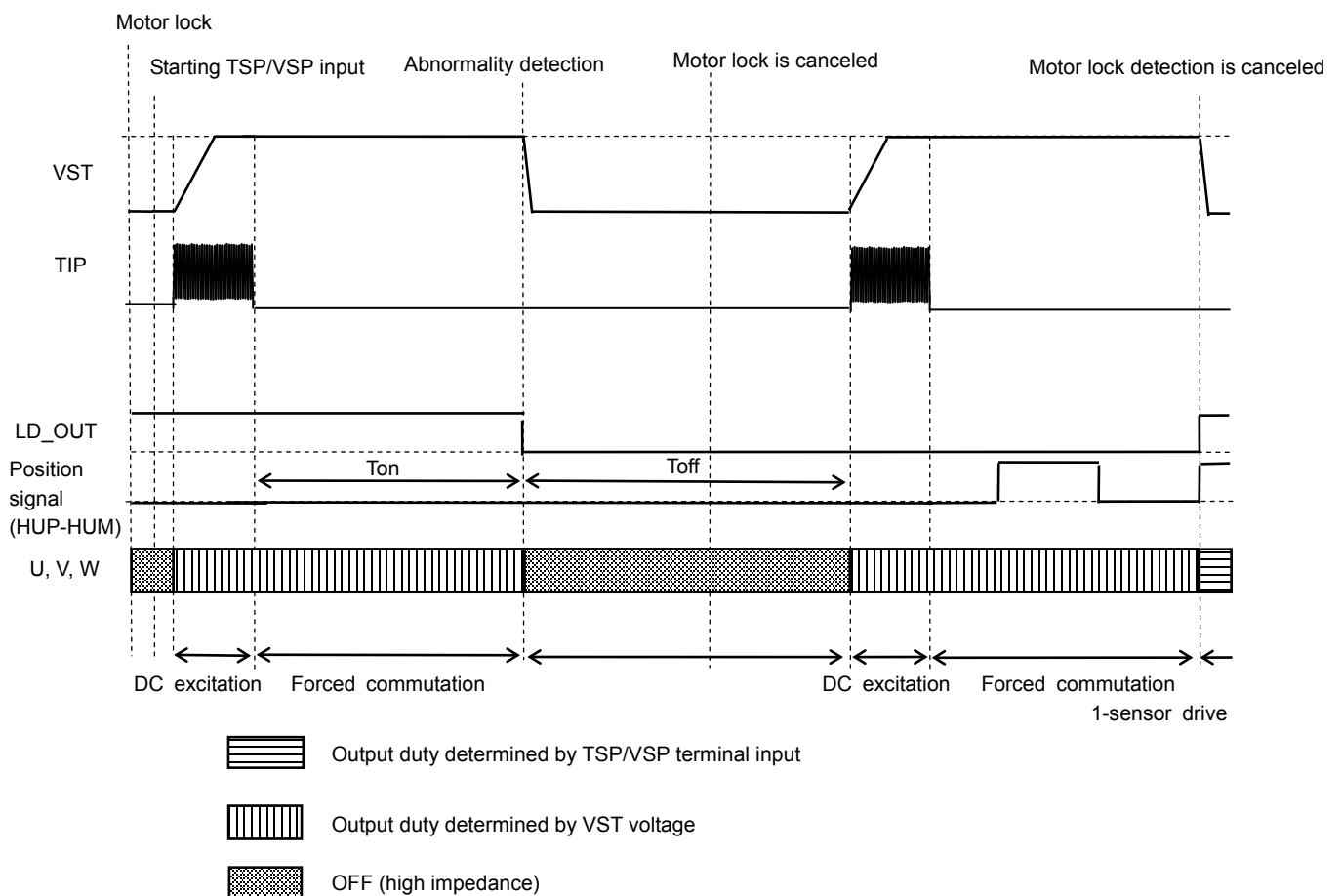

6. Forward /Reverse rotation direction switching

CW/CCW = Low: Forward direction, CW/CCW = High: Reverse direction.

When input level (H or L) of CW/CCW terminal is switched during 150-degree PWM drive, reverse brake operates until the position signal frequency decreases to 40 Hz or less. And then, it operates by the sequence of DC excitation, forced commutation, and 150-degree PWM drive.

CW/CCW	Order of conduction phase of output
L	Forward rotation direction: U→V→W→U→ ...
H	Reverse rotation direction: W→V→U→W→ ...

7. Rotation speed output

A rotation pulse based upon hall signals is output.

Either of 1 pulse, 2/3, 1/3, or 1/2 pulses per electrical angle can be selected by SEL_FG terminal. In selecting 2/3, 1/2, or 1/3 pulses per electrical angle, FG_OUT terminal outputs low when the frequency of the position signal is 1 Hz or less.

Number of steps set by SEL_FG terminal	FG_OUT
3	1 pulse / electrical angle
2	2/3 pulses / electrical angle
1	1/3 pulses / electrical angle
0	1/2 pulses / electrical angle

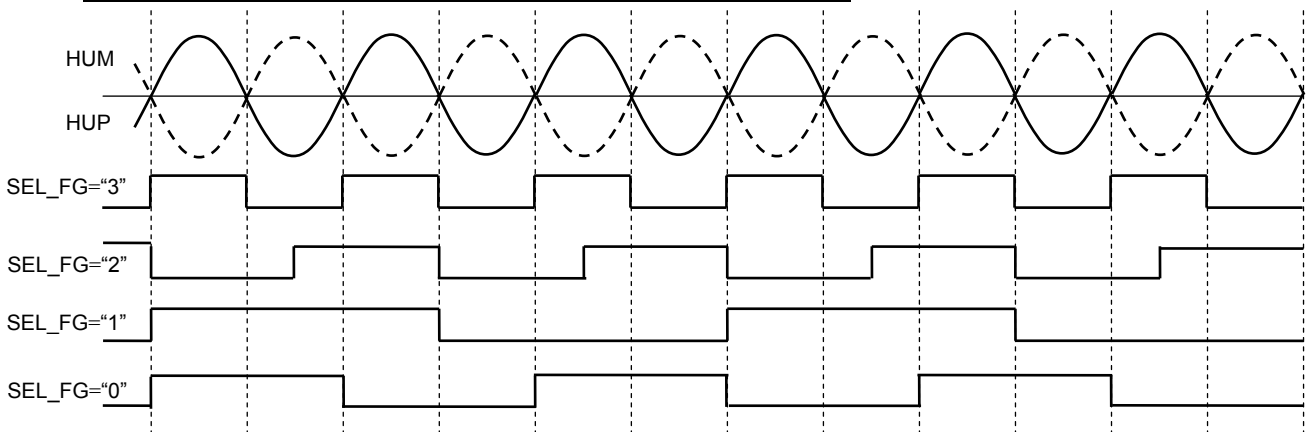

8. Rotational speed command

Startup, stop and motor rotational speed which is set by output PWM duty are able to be controlled by an input signal into TSP/VSP terminal.

Pulse duty control, analog voltage control, or direct PWM control can be selected as a mode of TSP/VSP terminal by the number of steps set by SEL_SP terminal.

Output PWM duty in DC excitation mode and forced commutation mode is according to VST voltage.

Number of steps set by SEL_SP terminal	Input control at TSP/VSP terminal
2	Analog voltage control
1	Pulse duty control
0	Direct PWM control

1) Relation of VST terminal voltage and output PWM duty

- $0 \leq \text{VST voltage} \leq 0.625 \text{ V (typ.)}$
→ Duty = 0 %
- $0.625 \text{ V (typ.)} \leq \text{VST voltage} \leq 3.125 \text{ V (typ.)}$
→ See the right figure (1/128 to 128/128)
- $3.125 \text{ V (typ.)} \leq \text{VST voltage} \leq \text{VREG}$
→ Duty = 100 % (128/128)

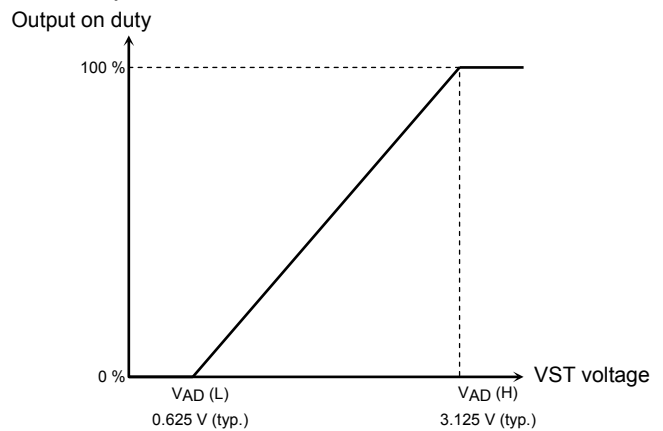

2) Relation of TSP/VSP terminal voltage and output PWM duty in controlling analog voltage (SEL_SP="2")

When the voltage of TSP/VSP terminal $\geq 0.625 \text{ V}$, startup sequence starts.
When the voltage of TSP/VSP terminal $< 0.625 \text{ V}$, the sequence is reset.

- $0 \leq \text{VSP/TSP (when analog voltage control)} \leq V_{AD} (L): 0.625 \text{ V (typ.)}$
→ Duty = 0 %
- $V_{AD} (L): 0.625 \text{ V (typ.)} \leq \text{VSP/TSP (when analog voltage control)} \leq V_{AD} (H): 3.125 \text{ V (typ.)}$
→ See the below figure. (1/128 to 128/128)
- $V_{AD} (H) 3.125 \text{ V (typ.)} \leq \text{VSP/TSP (when analog voltage control)} \leq \text{VREG}$
→ Duty = 100 % (128/128)

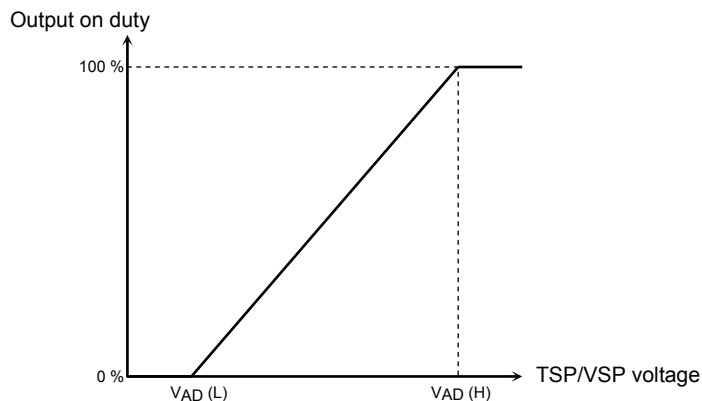

3) Relation of TSP/VSP terminal voltage and output PWM duty in controlling pulse duty (SEL_SP="1")

When a PWM signal is input into TSP/VSP terminal, startup sequence starts.

The pulse frequency input into TSP/VSP terminal should be set from 1 kHz to 100 kHz. Because input signal may be ineffective when on duty is for 0.2 μs or less. Because the operation may be judged off state when output off duty is for 1 ms or more.

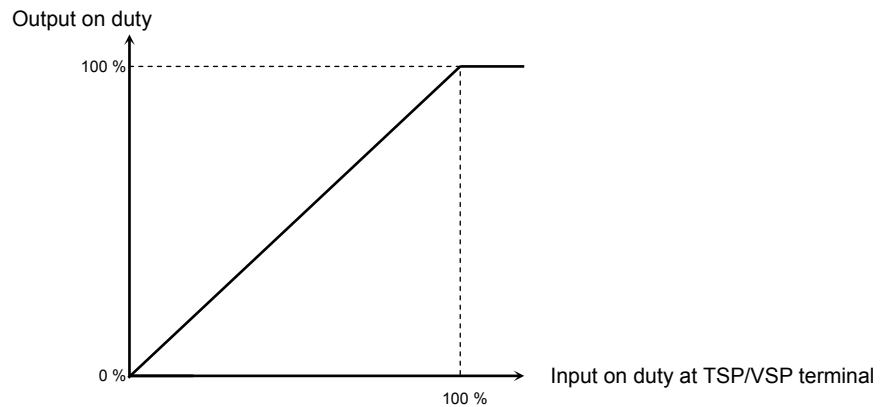

4) Relation of TSP/VSP terminal voltage and output PWM duty in controlling direct PWM (SEL_SP = "0")

When a PWM signal is input into TSP/VSP terminal, startup sequence starts.

The pulse frequency of input into TSP/VSP terminal should be set from 23 kHz to 100 kHz.

The PWM frequency in DC excitation mode and forced commutation mode is determined by configuration of FPWM terminal and the output PWM duty is determined by the input voltage of VST terminal. The PWM frequency of 150-degree PWM drive is determined by the input signal of TSP/VSP terminal.

When SEL_SP is "0", configurations of TSTEP terminal and MIN_SP terminal become invalid, and the functions of control configuration of acceleration and deceleration and configuration of minimum output on-duty become invalid.

9. Setting minimum output on duty

Minimum output on duty is determined by the input voltage into MIN_SP terminal.

However, minimum output on-duty becomes invalid for MIN_SP terminal in DC excitation mode, forced commutation mode, and setting SEL_SP = "0".

Number of steps set by MIN_SP terminal	Minimum output duty [%]
8	20.3
7	
6	18.8
5	17.2
4	15.6
3	14.1
2	12.5
1	10.9
0	0

10. PWM frequency

Output PWM frequency either in analog voltage control or in pulse duty control is determined by input voltage at FPWM terminal.

Output PWM frequency should be much higher than the electrical frequency of the motor. Please determine the value within switching performance of the drive circuits.

Number of steps set by FPWM terminal	PWM frequency
3	25 kHz
2	200 kHz
1	100 kHz
0	50 kHz

11. Lead angle control

Lead angle control mode is determined by setting both SEL_LA and LA terminal.

Number of steps set by SEL_LA terminal	Functional description
2	Test mode
1	Auto lead angle: Auto lead angle mode is selected by input voltage of LA terminal
0	External input: Lead angle value is configured by input voltage of LA terminal

1) Auto lead angle (SEL_LA = "1")

The threshold of the frequency has hysteresis +0 Hz/-50 Hz.

Lead angle value [deg]

Number of steps set by LA terminal	Electrical frequency [Hz]									
	0 to 100	100 to 200	200 to 300	300 to 400	400 to 500	500 to 600	600 to 700	700 to 800	800 to 900	900 to 1000
7	0	1.875	1.875	1.875	1.875	3.750	3.750	3.750	3.750	5.625
6	0	1.875	1.875	3.750	3.750	5.625	5.625	7.500	7.500	9.325
5	0	1.875	1.875	3.750	5.625	7.500	7.500	9.325	11.250	13.125
4	0	1.875	3.750	5.625	9.325	11.250	13.125	15.000	18.750	20.625
3	0	1.875	5.625	7.500	11.250	13.125	16.875	18.750	22.500	24.375
2	0	3.750	5.625	9.325	13.125	16.875	18.750	22.500	26.250	30.000
1	0	3.750	7.500	11.250	15.000	18.750	22.500	26.250	30.000	33.750
0	0	1.875	3.750	5.625	7.500	9.325	11.250	13.125	15.000	16.875

Lead angle value [deg]

Number of steps set by LA terminal	Electrical frequency [Hz]										
	1000 to 1100	1100 to 1200	1200 to 1300	1300 to 1400	1400 to 1500	1500 to 1600	1600 to 1700	1700 to 1800	1800 to 1900	1900 to 2000	More than 2000
7	5.625	5.625	5.625	7.500	7.500	7.500	7.500	9.375	9.375	9.375	9.375
6	9.325	11.250	11.250	13.125	13.125	15.000	15.000	16.875	16.875	18.750	18.750
5	13.125	15.000	16.875	18.750	18.750	20.625	22.500	24.375	24.375	26.250	28.125
4	22.500	24.375	28.125	30.000	31.875	33.750	37.500	39.375	41.250	43.125	46.875
3	28.125	30.000	33.750	35.625	39.375	41.250	45.000	46.875	50.625	52.500	56.250
2	31.875	35.625	39.375	43.125	45.000	48.750	52.500	56.250	58.125	58.125	58.125
1	37.500	41.250	45.000	48.750	52.500	56.250	56.250	56.250	56.250	56.250	56.250
0	18.750	20.625	22.500	24.375	26.250	28.125	30.000	31.875	33.750	35.625	37.500

2) External input (SEL_LA = "0")

Lead angle in the range of 0° to 58.125° as commutation signals which correspond to the induced voltage can be adjusted.

The range from 0 V to 3.125 V as analog input voltage into LA terminal is divided into 32 parts.

Input voltage into LA terminal = 0 V: lead angle = 0°.

Input voltage into LA terminal = 3.125 V: lead angle = 58.125°.

Input voltage ≥ 3.125 V, input voltage: lead angle = 58.125°.

(Design value)

Number of steps	LA [V]	Lead angle [deg]	Number of steps	LA [V]	Lead angle [deg]
31	3.125	58.125	15	1.563	28.125
30	3.027	56.250	14	1.465	26.250
29	2.930	54.375	13	1.367	24.375
28	2.832	52.500	12	1.270	22.500
27	2.734	50.625	11	1.172	20.625
26	2.637	48.750	10	1.074	18.750
25	2.539	46.875	9	0.977	16.875
24	2.441	45.000	8	0.879	15.000
23	2.344	43.125	7	0.781	13.125
22	2.246	41.250	6	0.684	11.250
21	2.148	39.375	5	0.586	9.375
20	2.051	37.500	4	0.488	7.500
19	1.953	35.625	3	0.391	5.625
18	1.855	33.750	2	0.293	3.750
17	1.758	31.875	1	0.195	1.875
16	1.660	30.000	0	0.000	0.000

12. Acceleration and deceleration control setting

Time to reflect the duty of the input control signal of TSP/VSP terminal in the output duty during acceleration and deceleration can be set by connecting the capacitor to TSTEP terminal. (About 0.078 %/T) Therefore, the rotation speed can accelerate and slow down gradually in startup. However, when change of the duty of an input control signal is 2.5 % or less, it is reflected in output duty for every PWM cycle. Acceleration and deceleration time: (For example) When $C = 0.01 \mu\text{F}$, $32 \times T = 32 \times 0.313 \times C \times 10^6 =$ about 0.100 s.

When the speed command that the output on duty is 0 % is inputted during operation, the deceleration function becomes invalid, and the output is turned off. At this time, an output duty is reset to 0 %. When restarting, please input a start command signal to TSP/VSP pin after inputting a speed control command that the output on duty is 0 % for 2 ms or more.

In case of 7.5 % increase in input DUTY

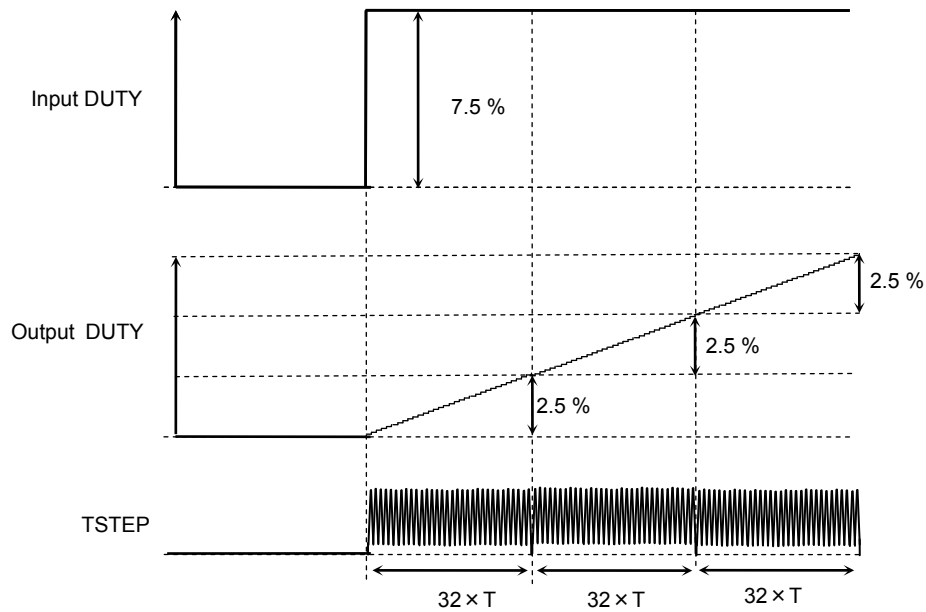

In case of 7.5 % decrease in input DUTY

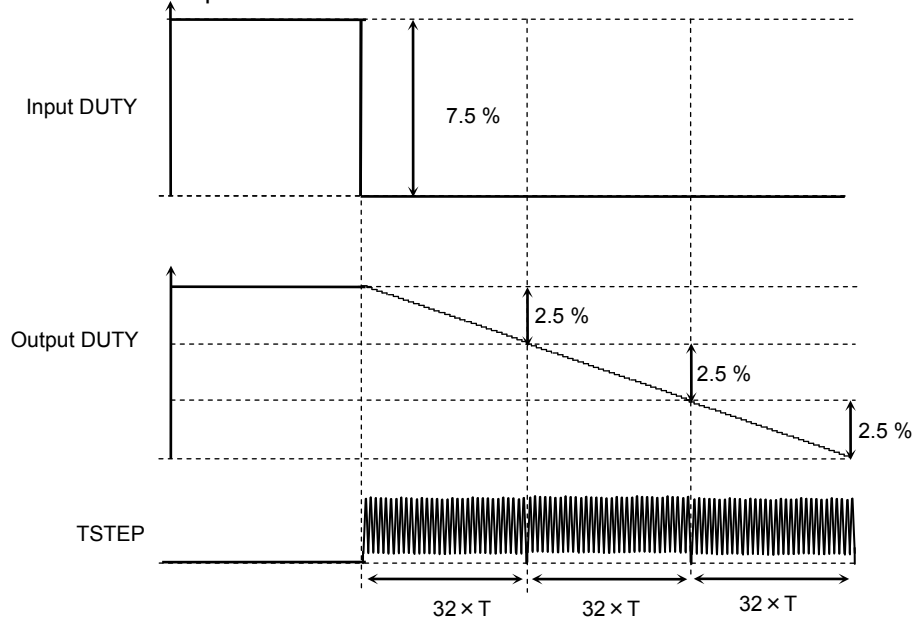

13. Brake function

If high level is input into BRAKE terminal, the reverse brake works to stop the motor operation. After the input signal into BRAKE terminal is changed from L level to H level during the motor rotation, the reverse brake works until the position signal frequency becomes 40 Hz. When the position signal frequency is less than 40 Hz, the motor will stop.

However, when the input signal into BRAKE terminal is changed from L level to H level under the condition that the output duty command of TSP/VSP terminal is 0 %, the operation sequence is shown as the below table.

BRAKE	Functional description
High	Brake
Low or open	Normal operation

In case the input signal into BRAKE terminal is changed from L level to H level under the condition that the output duty command of TSP/VSP terminal is 0 %

Detection of rotation direction	Status	Brake sequence
Enable	Position signal frequency ≤ 40 Hz	Short brake
	Position signal frequency > 40 Hz	Reverse brake → Short brake
Disenable	Position signal frequency ≤ 200 Hz or less	Short brake
	Position signal frequency > 200 Hz or more	Detection of rotation direction is retried

14. Overvoltage monitoring function

When MVM = 2.0 V (typ.) or more, drive mode is 120-degree conduction. MVM has 0.2 V (typ.) of hysteresis. If MVM < 1.8 V (typ.), drive restarts.

MVM	Functional description
MVM ≥ 2.0 V (typ.)	120-degree commutation
MVM < 1.8 V (typ.)	150-degree commutation

15. Current limit circuit

Current limit circuit turns off upper side of the output transistors and limits the current. Driver restarts just when PWM turns on.

Value of current limit is configured by the external resistance.

(Example) When 39 kΩ is set as the resistor (R), $I_{OUT} (typ.) = 39000/R = 39000/39000 \approx 1.0 \text{ A}$

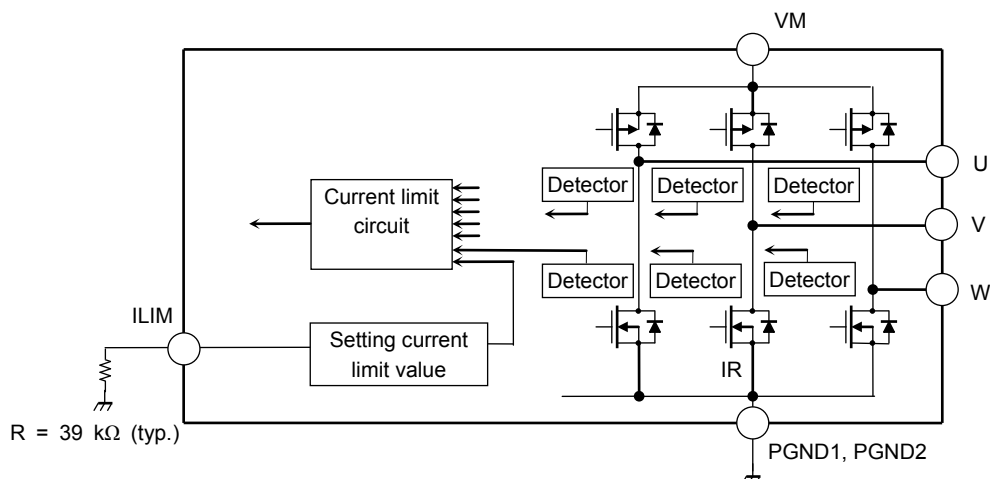

16. Overcurrent detection circuit (ISD)

Six overcurrent detectors are built in each output transistor. If detected value exceeds the absolute maximum rating, all of outputs are turned off (high impedance: Hi-Z).

If output on duty of rotational speed command is set 0 %, abnormality detection is released.

Please input a rotational speed command (0 % for 2 ms or more) to release the abnormality detection.

17. Thermal shutdown circuit (TSD)

It turns off output (high impedance: Hi-Z), when the junction temperature (T_j) exceeds 165°C (typ.). There is 15°C (typ.) of hysteresis.

Temperature for restart is $T_{SD} - T_{SDhys}$ after thermal shutdown circuit operates.

$T_{SD} = 165^\circ\text{C}$ (typ.), $T_{SDhys} = 15^\circ\text{C}$ (typ.)

18. Under voltage lockout (UVLO)

It turns off each output of U, V, W, FG_OUT and LD_OUT (high impedance: Hi-Z), when VM is 5.3 V (typ.) or less. There is 0.3 V (typ.) of hysteresis. Voltage for restart is 5.6 V (typ.).

Timing chart

1) CW/CCW = L, LA = 0 [deg]

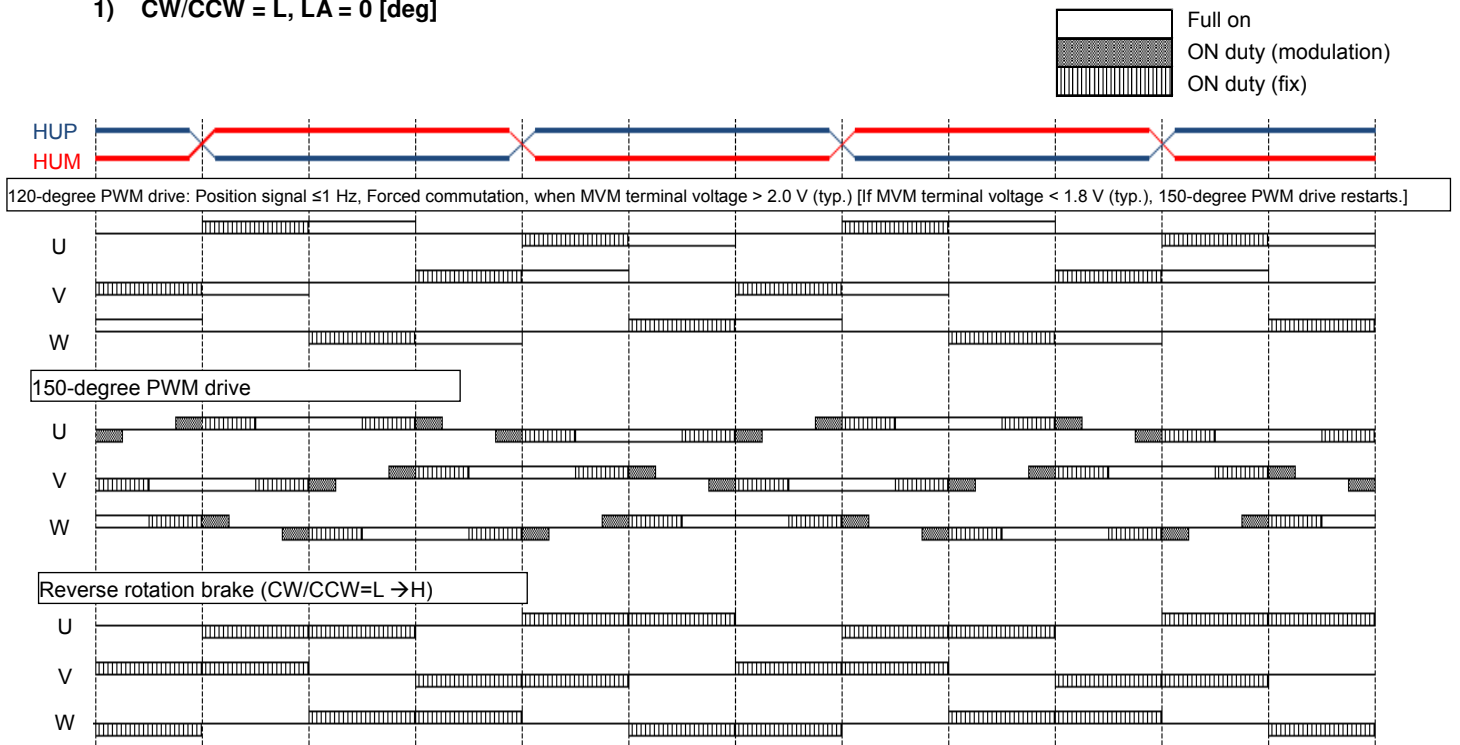

In this timing chart, the reverse rotation brake is indicated without current limit.

2) CW/CCW = H, LA = 0 [deg]

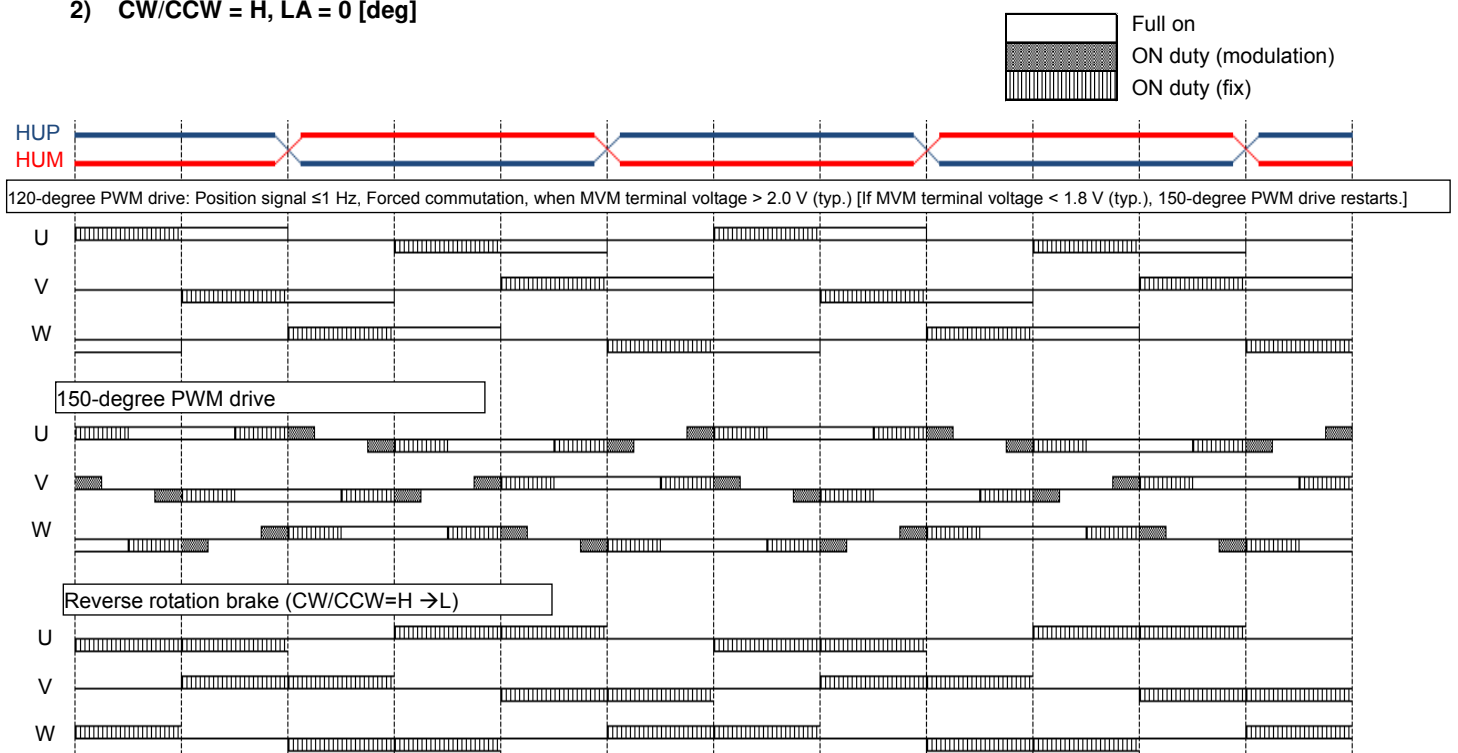

In this timing chart, the reverse rotation brake is indicated without current limit.

Application circuit example

Some of the functional blocks, circuits, or constants in the block diagram may be omitted or simplified for explanatory purposes. The application circuits shown in this document are provided for reference purposes only. Thorough evaluation is required, especially at the mass production design stage.

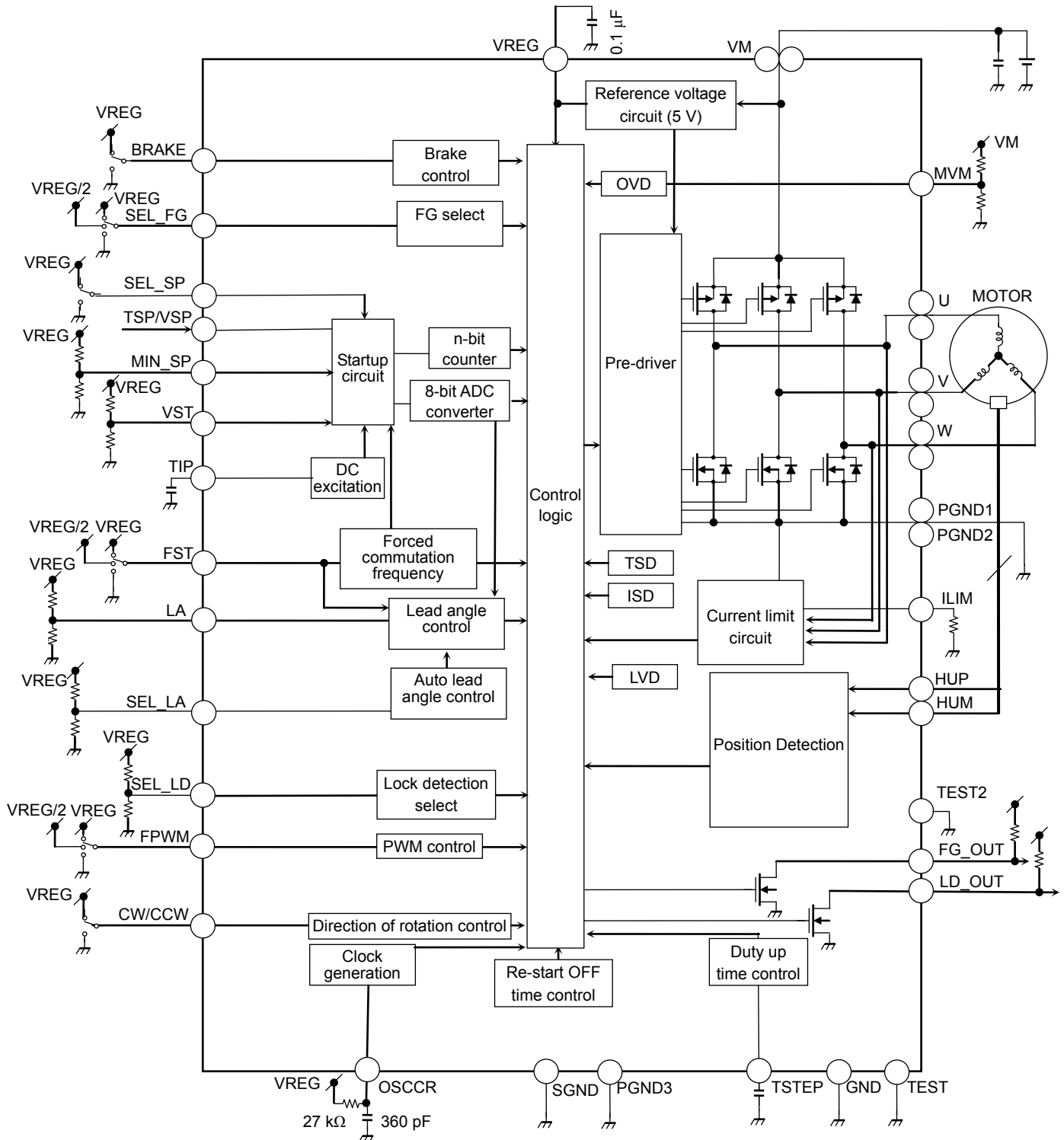

Package Dimensions

P-WQFN36-0505-0.50-001

Unit: mm

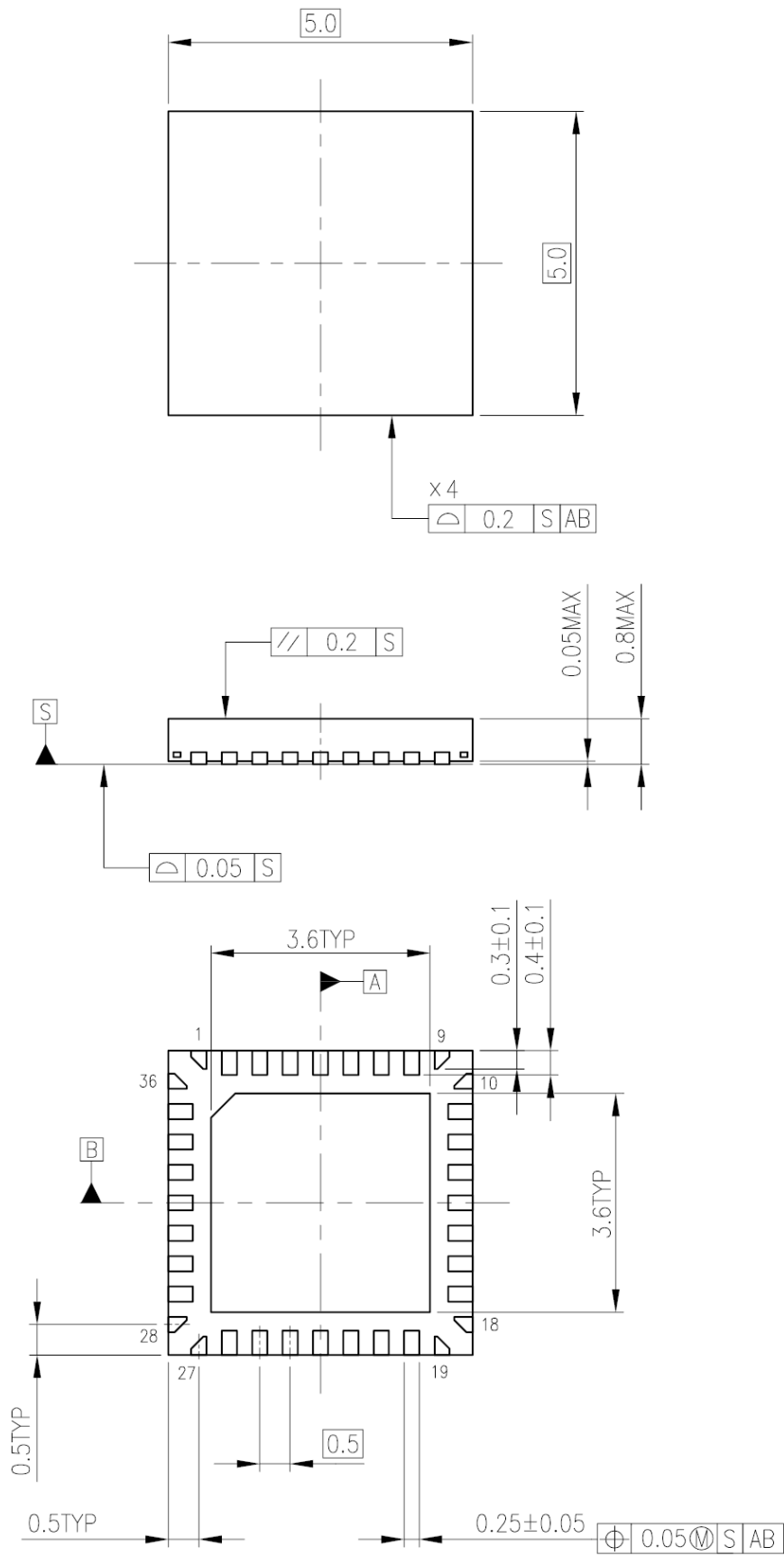

Weight: 0.06 g (typ.)

Notes on Contents

1. Block Diagrams

Some of the functional blocks, circuits, or constants in the block diagram may be omitted or simplified for explanatory purposes.

2. Equivalent Circuits

The equivalent circuit diagrams may be simplified or some parts of them may be omitted for explanatory purposes.

3. Timing Charts

Timing charts may be simplified for explanatory purposes.

4. Application Circuits

The application circuits shown in this document are provided for reference purposes only. Thorough evaluation is required, especially at the mass production design stage. Toshiba does not grant any license to any industrial property rights by providing these examples of application circuits.

5. Test Circuits

Components in the test circuits are used only to obtain and confirm the device characteristics. These components and circuits are not guaranteed to prevent malfunction or failure from occurring in the application equipment.

IC Usage Considerations

Notes on handling of ICs

- (1) The absolute maximum ratings of a semiconductor device are a set of ratings that must not be exceeded, even for a moment. Do not exceed any of these ratings.
Exceeding the rating(s) may cause the device breakdown, damage or deterioration, and may result injury by explosion or combustion.
- (2) Use an appropriate power supply fuse to ensure that a large current does not continuously flow in case of over current and/or IC failure. The IC will fully break down when used under conditions that exceed its absolute maximum ratings, when the wiring is routed improperly or when an abnormal pulse noise occurs from the wiring or load, causing a large current to continuously flow and the breakdown can lead smoke or ignition. To minimize the effects of the flow of a large current in case of breakdown, appropriate settings, such as fuse capacity, fusing time and insertion circuit location, are required.
- (3) If your design includes an inductive load such as a motor coil, incorporate a protection circuit into the design to prevent device malfunction or breakdown caused by the current resulting from the inrush current at power ON or the negative current resulting from the back electromotive force at power OFF. IC breakdown may cause injury, smoke or ignition. Use a stable power supply with ICs with built-in protection functions. If the power supply is unstable, the protection function may not operate, causing IC breakdown. IC breakdown may cause injury, smoke or ignition.
- (4) Do not insert devices in the wrong orientation or incorrectly. Make sure that the positive and negative terminals of power supplies are connected properly. Otherwise, the current or power consumption may exceed the absolute maximum rating, and exceeding the rating(s) may cause the device breakdown, damage or deterioration, and may result injury by explosion or combustion. In addition, do not use any device that is applied the current with inserting in the wrong orientation or incorrectly even just one time.

Points to remember on handling of ICs

- (1) **Over current Protection Circuit**

Over current protection circuits (referred to as current limiter circuits) do not necessarily protect ICs under all circumstances. If the Over current protection circuits operate against the over current, clear the over current status immediately. Depending on the method of use and usage conditions, such as exceeding absolute maximum ratings can cause the over current protection circuit to not operate properly or IC breakdown before operation. In addition, depending on the method of use and usage conditions, if over current continues to flow for a long time after operation, the IC may generate heat resulting in breakdown.
- (2) **Thermal Shutdown Circuit**

Thermal shutdown circuits do not necessarily protect ICs under all circumstances. If the thermal shutdown circuits operate against the over temperature, clear the heat generation status immediately. Depending on the method of use and usage conditions, such as exceeding absolute maximum ratings can cause the thermal shutdown circuit to not operate properly or IC breakdown before operation.
- (3) **Heat Radiation Design**

In using an IC with large current flow such as power amp, regulator or driver, please design the device so that heat is appropriately radiated, not to exceed the specified junction temperature (T_j) at any time and condition. These ICs generate heat even during normal use. An inadequate IC heat radiation design can lead to decrease in IC life, deterioration of IC characteristics or IC breakdown. In addition, please design the device taking into consideration the effect of IC heat radiation with peripheral components.
- (4) **Back-EMF**

When a motor rotates in the reverse direction, stops or slows down abruptly, a current flow back to the motor's power supply due to the effect of back-EMF. If the current sink capability of the power supply is small, the device's motor power supply and output pins might be exposed to conditions beyond absolute maximum ratings. To avoid this problem, take the effect of back-EMF into consideration in system design.

RESTRICTIONS ON PRODUCT USE

- Toshiba Corporation, and its subsidiaries and affiliates (collectively "TOSHIBA"), reserve the right to make changes to the information in this document, and related hardware, software and systems (collectively "Product") without notice.
- This document and any information herein may not be reproduced without prior written permission from TOSHIBA. Even with TOSHIBA's written permission, reproduction is permissible only if reproduction is without alteration/omission.
- Though TOSHIBA works continually to improve Product's quality and reliability, Product can malfunction or fail. Customers are responsible for complying with safety standards and for providing adequate designs and safeguards for their hardware, software and systems which minimize risk and avoid situations in which a malfunction or failure of Product could cause loss of human life, bodily injury or damage to property, including data loss or corruption. Before customers use the Product, create designs including the Product, or incorporate the Product into their own applications, customers must also refer to and comply with (a) the latest versions of all relevant TOSHIBA information, including without limitation, this document, the specifications, the data sheets and application notes for Product and the precautions and conditions set forth in the "TOSHIBA Semiconductor Reliability Handbook" and (b) the instructions for the application with which the Product will be used with or for. Customers are solely responsible for all aspects of their own product design or applications, including but not limited to (a) determining the appropriateness of the use of this Product in such design or applications; (b) evaluating and determining the applicability of any information contained in this document, or in charts, diagrams, programs, algorithms, sample application circuits, or any other referenced documents; and (c) validating all operating parameters for such designs and applications. **TOSHIBA ASSUMES NO LIABILITY FOR CUSTOMERS' PRODUCT DESIGN OR APPLICATIONS.**
- **PRODUCT IS NEITHER INTENDED NOR WARRANTED FOR USE IN EQUIPMENTS OR SYSTEMS THAT REQUIRE EXTRAORDINARILY HIGH LEVELS OF QUALITY AND/OR RELIABILITY, AND/OR A MALFUNCTION OR FAILURE OF WHICH MAY CAUSE LOSS OF HUMAN LIFE, BODILY INJURY, SERIOUS PROPERTY DAMAGE AND/OR SERIOUS PUBLIC IMPACT ("UNINTENDED USE").** Except for specific applications as expressly stated in this document, Unintended Use includes, without limitation, equipment used in nuclear facilities, equipment used in the aerospace industry, medical equipment, equipment used for automobiles, trains, ships and other transportation, traffic signaling equipment, equipment used to control combustions or explosions, safety devices, elevators and escalators, devices related to electric power, and equipment used in finance-related fields. **IF YOU USE PRODUCT FOR UNINTENDED USE, TOSHIBA ASSUMES NO LIABILITY FOR PRODUCT.** For details, please contact your TOSHIBA sales representative.
- Do not disassemble, analyze, reverse-engineer, alter, modify, translate or copy Product, whether in whole or in part.
- Product shall not be used for or incorporated into any products or systems whose manufacture, use, or sale is prohibited under any applicable laws or regulations.
- The information contained herein is presented only as guidance for Product use. No responsibility is assumed by TOSHIBA for any infringement of patents or any other intellectual property rights of third parties that may result from the use of Product. No license to any intellectual property right is granted by this document, whether express or implied, by estoppel or otherwise.
- **ABSENT A WRITTEN SIGNED AGREEMENT, EXCEPT AS PROVIDED IN THE RELEVANT TERMS AND CONDITIONS OF SALE FOR PRODUCT, AND TO THE MAXIMUM EXTENT ALLOWABLE BY LAW, TOSHIBA (1) ASSUMES NO LIABILITY WHATSOEVER, INCLUDING WITHOUT LIMITATION, INDIRECT, CONSEQUENTIAL, SPECIAL, OR INCIDENTAL DAMAGES OR LOSS, INCLUDING WITHOUT LIMITATION, LOSS OF PROFITS, LOSS OF OPPORTUNITIES, BUSINESS INTERRUPTION AND LOSS OF DATA, AND (2) DISCLAIMS ANY AND ALL EXPRESS OR IMPLIED WARRANTIES AND CONDITIONS RELATED TO SALE, USE OF PRODUCT, OR INFORMATION, INCLUDING WARRANTIES OR CONDITIONS OF MERCHANTABILITY, FITNESS FOR A PARTICULAR PURPOSE, ACCURACY OF INFORMATION, OR NONINFRINGEMENT.**
- Do not use or otherwise make available Product or related software or technology for any military purposes, including without limitation, for the design, development, use, stockpiling or manufacturing of nuclear, chemical, or biological weapons or missile technology products (mass destruction weapons). Product and related software and technology may be controlled under the applicable export laws and regulations including, without limitation, the Japanese Foreign Exchange and Foreign Trade Law and the U.S. Export Administration Regulations. Export and re-export of Product or related software or technology are strictly prohibited except in compliance with all applicable export laws and regulations.
- Please contact your TOSHIBA sales representative for details as to environmental matters such as the RoHS compatibility of Product. Please use Product in compliance with all applicable laws and regulations that regulate the inclusion or use of controlled substances, including without limitation, the EU RoHS Directive. **TOSHIBA ASSUMES NO LIABILITY FOR DAMAGES OR LOSSES OCCURRING AS A RESULT OF NONCOMPLIANCE WITH APPLICABLE LAWS AND REGULATIONS.**