

GaAs pHEMT MMIC POWER AMPLIFIER, DC - 28 GHz

Typical Applications

The HMC994APM5E is ideal for:

- Test Instrumentation
- Military & Space
- Fiber optics

Features

- P1dB Output Power: +28 dBm
- Psat Output Power: +29 dBm
- High Gain: 15 dB
- Output IP3: +38 dBm
- Supply Voltage: Vdd = +10V @ 250 mA
- 50 Ohm Matched Input/Output
- 32 Lead 5x5 mm SMT Package: 25 mm²

Functional Diagram

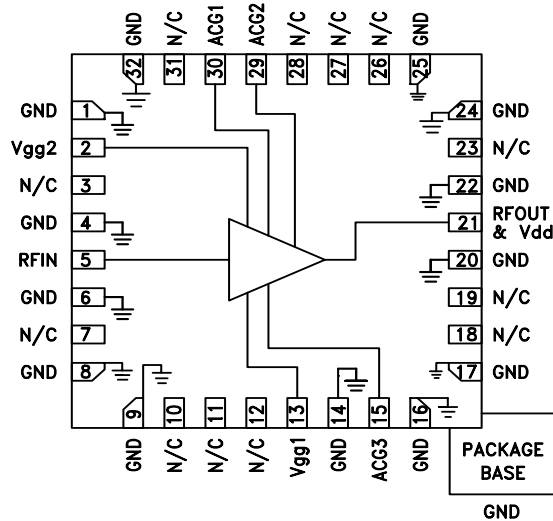

General Description

The HMC994APM5E is a GaAs pHEMT MMIC Distributed Wideband Power Amplifier which operates between DC and 28 GHz. The amplifier provides 15 dB of gain, +29 dBm of saturated output power, and 25% PAE from a +10V supply. With up to +38 dBm Output IP3 the HMC994APM5E is ideal for high linearity applications in military and space as well as test equipment where high order modulations are used. The HMC994APM5E exhibits a positive gain slope from 2 to 20 GHz making it ideal for EW, ECM, and test equipment applications. The HMC994APM5E amplifier I/Os are internally matched to 50 Ohms and is packaged in a leadless QFN 5x5 mm surface mount package.

Electrical Specifications, $T_A = +25^\circ C$, $V_{dd} = +10V$, $V_{gg2}=3.5V$ $I_{dd} = 250 mA$ [1]

Parameter	Min.	Typ.	Max.	Min.	Typ.	Max.	Min.	Typ..	Max.	Units
Frequency Range	DC - 10			10 - 20			20 - 28			GHz
Gain	12	14		12	15		13	16		dB
Gain Flatness		±0.5			±0.5			±0.5		dB
Gain Variation Over Temperature		0.008			0.011			1.016		dB/ °C
Input Return Loss		12			12			12		dB
Output Return Loss		25			22			20		dB
Output Power for 1 dB Compression (P1dB)	26	28		26	28		25	27		dBm
Saturated Output Power (Psat)		30			29.5			28		dBm
Output Third Order Intercept (IP3) Pout/tone = +16dBm		40			38			36		dBm
Noise Figure		4			3.5			4		dB
Supply Current (Idd)		250			250			250		mA
Supply Voltage (Vdd)	8	10	11	8	10	11	8	10	11	V

[1] Adjust Vgg1 to achieve Idd = 250 mA typical; Vgg1 = -0.50V typical.

**GaAs pHEMT MMIC
POWER AMPLIFIER, DC - 28 GHz**

Gain & Return Loss

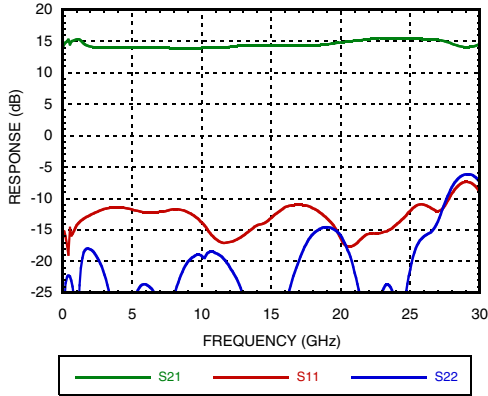

Low Frequency Gain & Return Loss

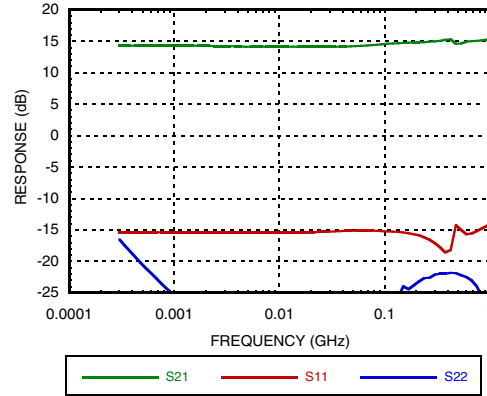

Gain vs. Temperature

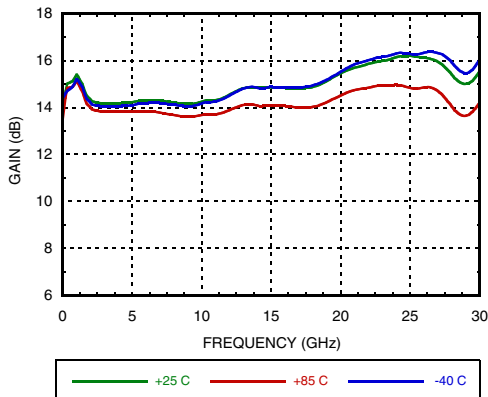

Gain vs. Vdd

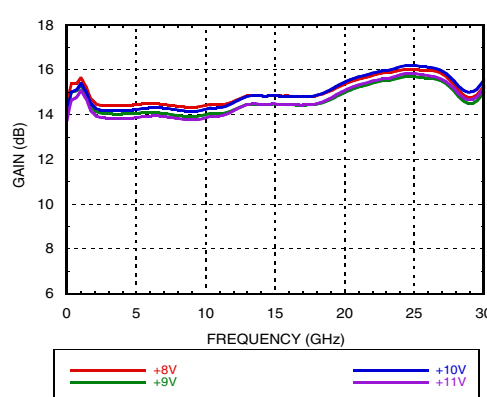

Gain vs. Idd

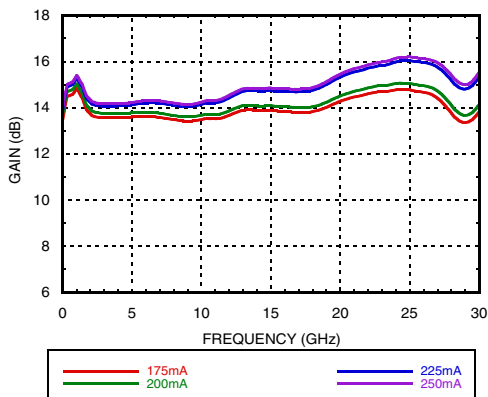

Input Return Loss vs. Temperature

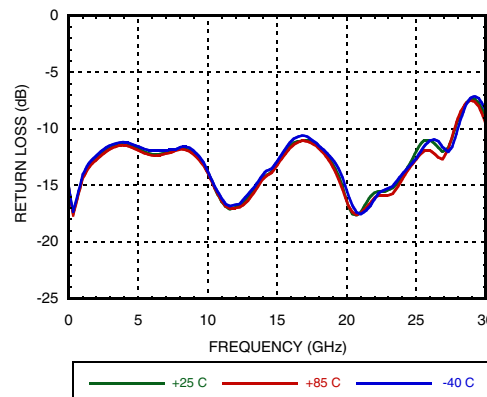

**GaAs pHEMT MMIC
POWER AMPLIFIER, DC - 28 GHz**

Input Return Loss vs. Vdd

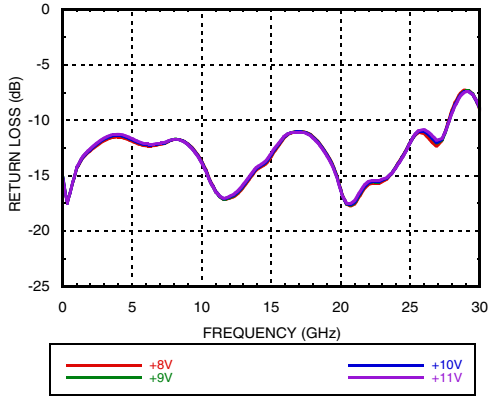

Input Return Loss vs. Idd

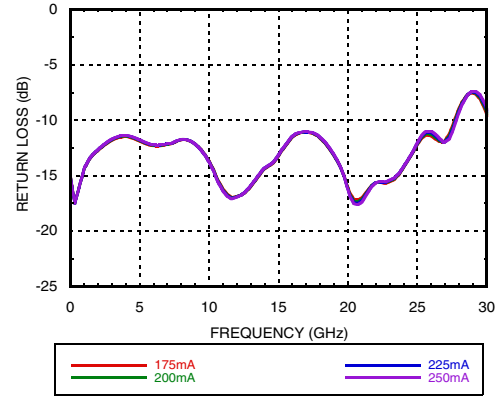

Output Return Loss vs. Temperature

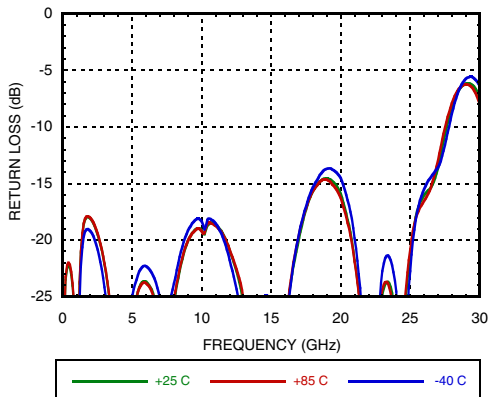

Output Return Loss vs. Vdd

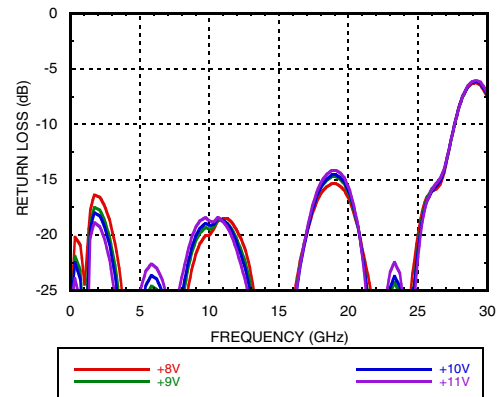

Output Return Loss vs. Idd

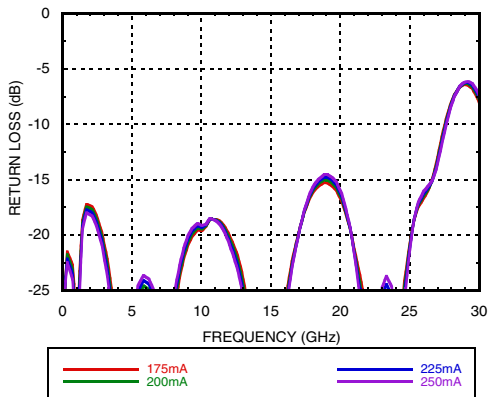

Reverse Isolation vs. Temperature

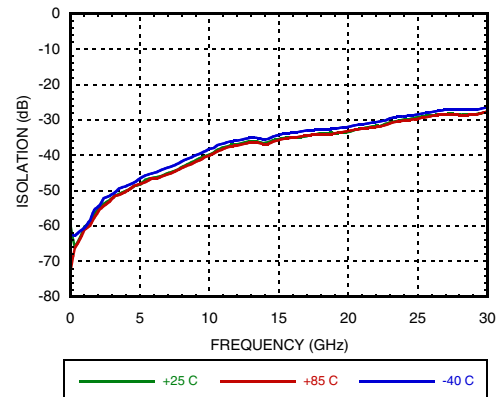

GaAs pHEMT MMIC POWER AMPLIFIER, DC - 28 GHz

Noise Figure vs. Temperature

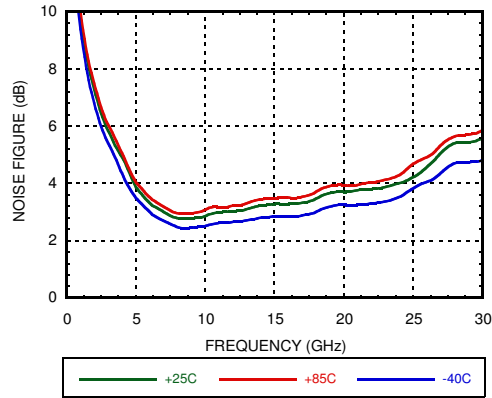

Noise Figure vs. I_{dd}

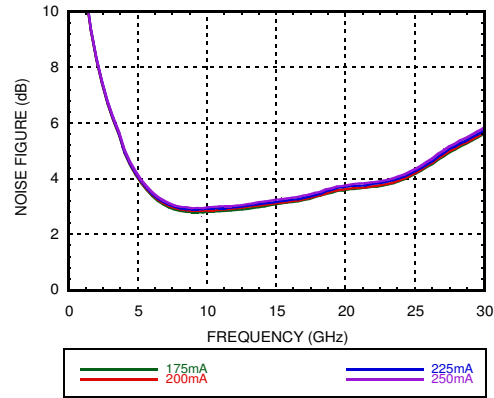

Low Frequency P_{1dB} vs. Temperature

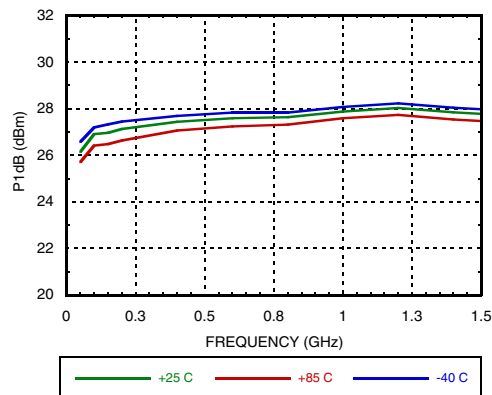

P_{1dB} vs. Temperature

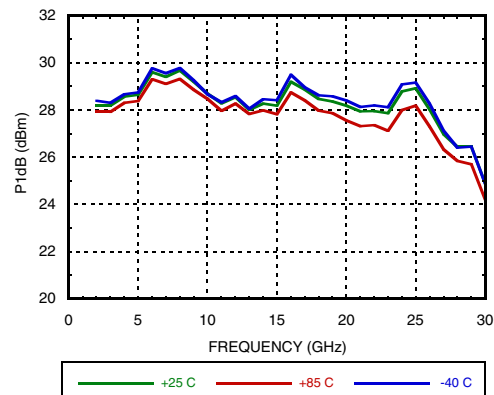

P_{1dB} vs. V_{dd}

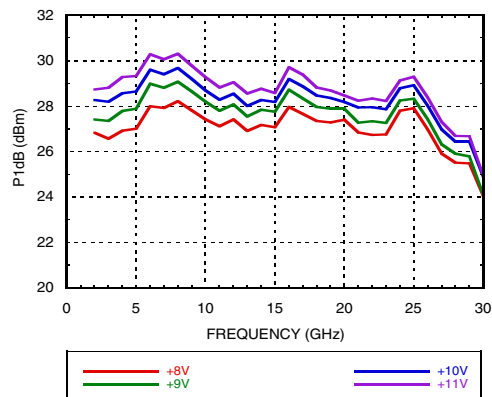

P_{1dB} vs. I_{dd}

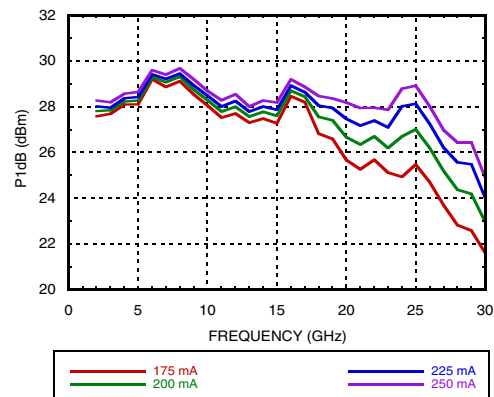

**GaAs pHEMT MMIC
POWER AMPLIFIER, DC - 28 GHz**

Low Frequency Psat vs. Temperature

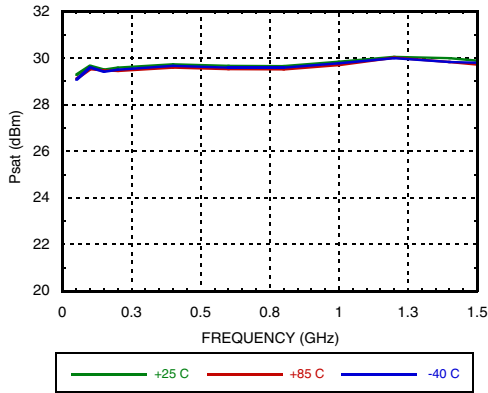

Psat vs. Temperature

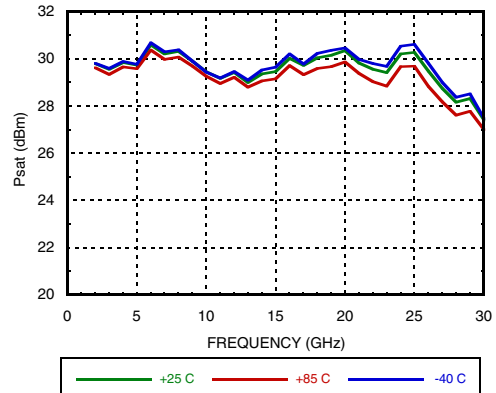

Psat vs. Vdd

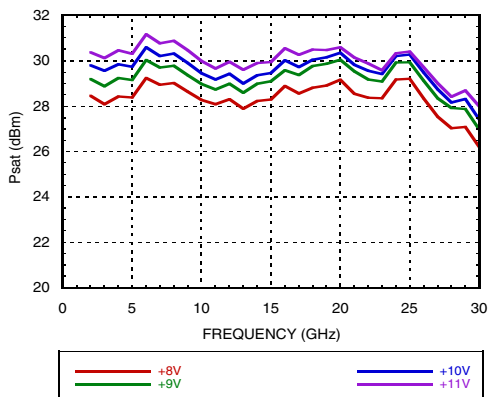

Psat vs. Idd

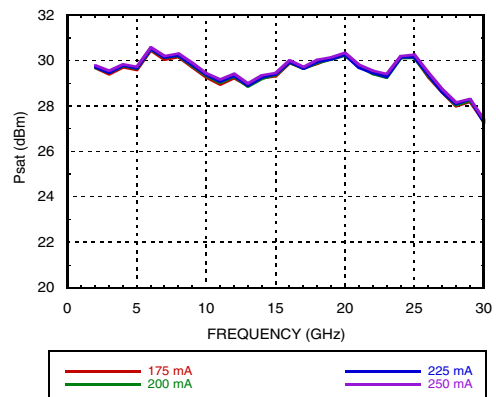

Power Compression @ 16 GHz

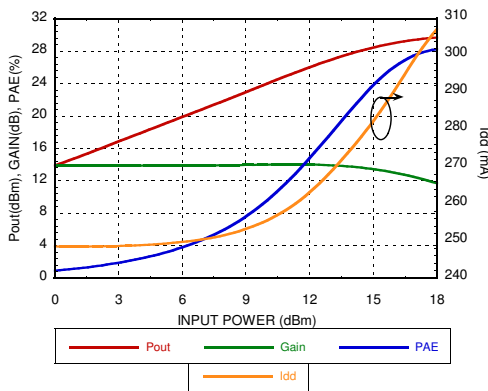

Gain & Power vs. Idd @ 16GHz

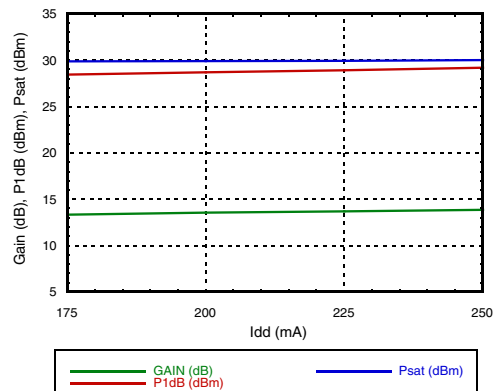

GaAs pHEMT MMIC POWER AMPLIFIER, DC - 28 GHz

Gain & Power vs. Vdd @ 16 GHz

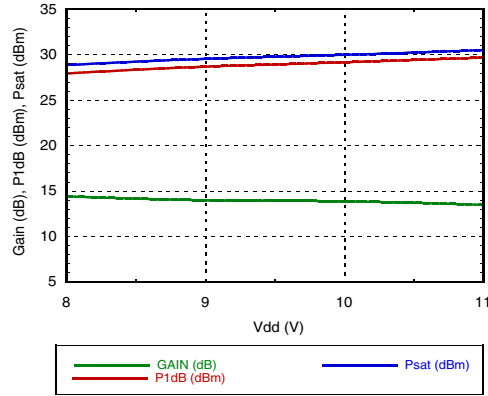

Power Dissipation

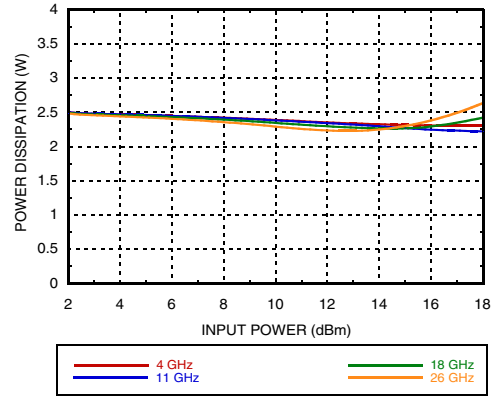

PAE @ Psat vs. Frequency

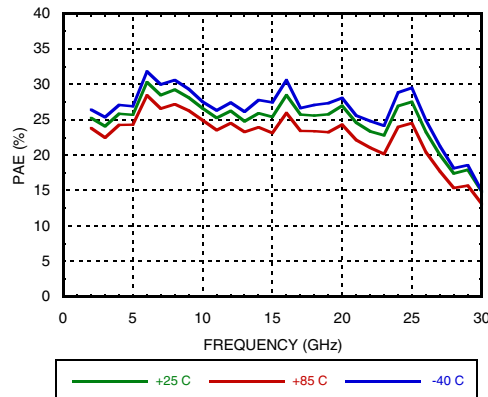

**Low Frequency OIP3 vs. Temperature
@ Pout/tone = +16dBm**

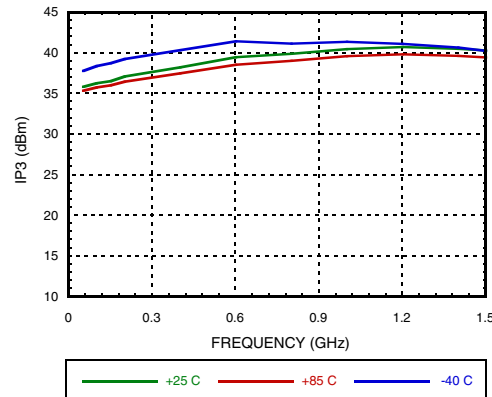

**OIP3 vs. Temperature
@ Pout/tone = +16dBm**

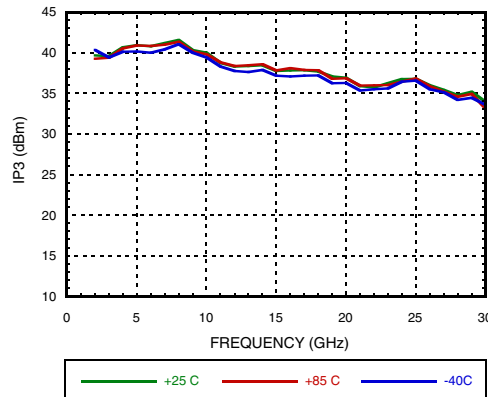

OIP3 vs. Vdd @ Pout/tone = +16dBm

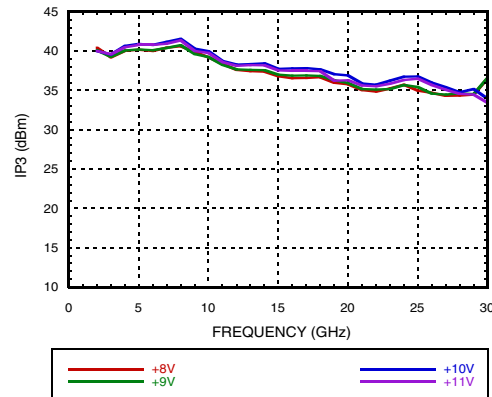

**GaAs pHEMT MMIC
POWER AMPLIFIER, DC - 28 GHz**

OIP3 vs Idd @ Pout/tone = +16dBm

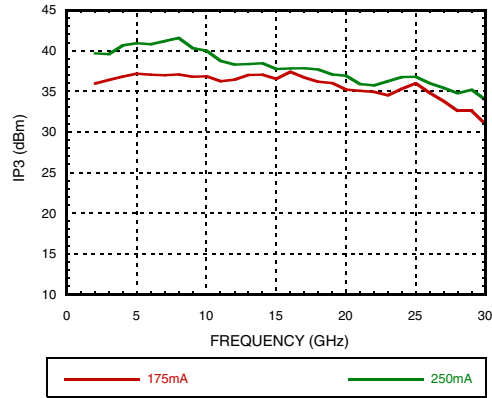

Output IM3 @ Vdd = 8V

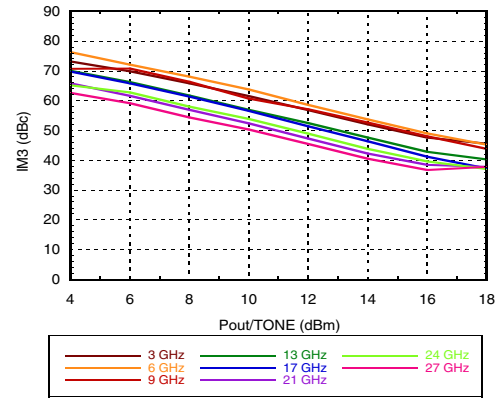

Output IM3 @ Vdd = 9V

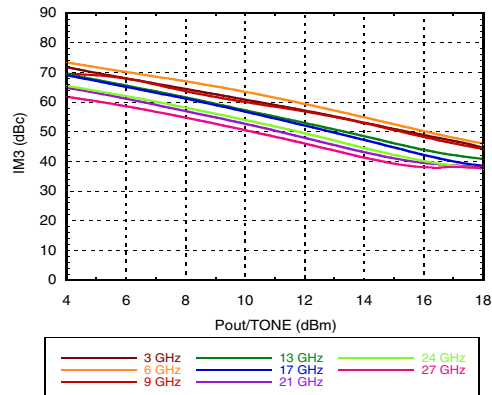

Output IM3 @ Vdd = 10V

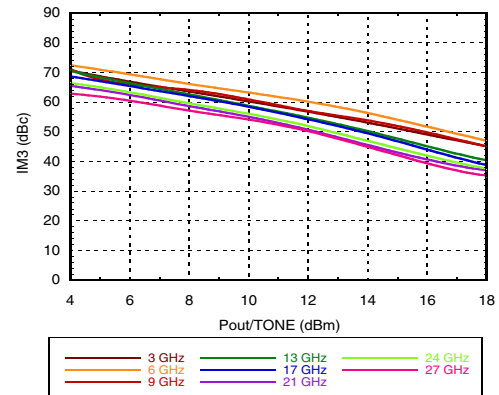

Output IM3 @ Vdd = 11V

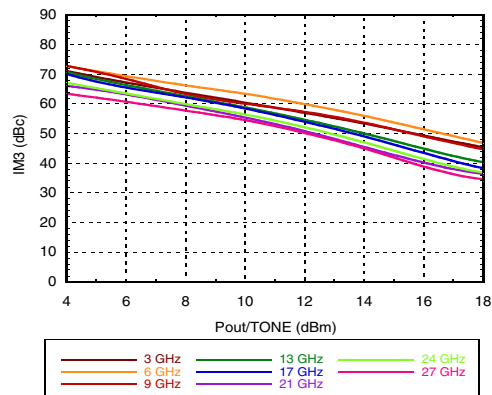

Low Frequency Second Harmonics vs. Temperature @ Pout = +14dBm

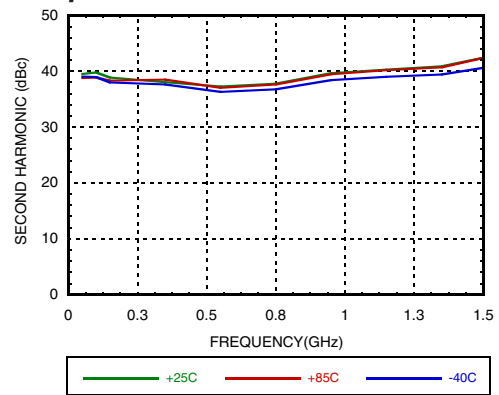

**GaAs pHEMT MMIC
POWER AMPLIFIER, DC - 28 GHz**

**Second Harmonics vs. Temperature
@ Pout = +14dBm**

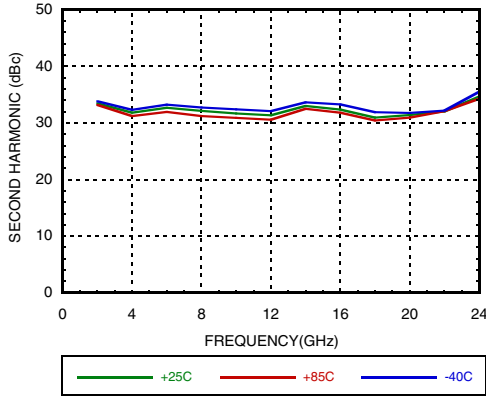

**Second Harmonics vs. Vdd
@ Pout = +14dBm**

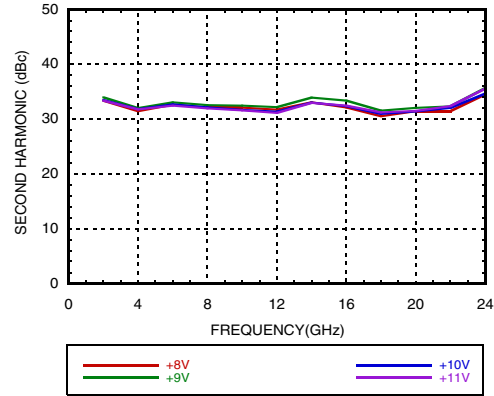

**Second Harmonics vs Idd
@ Pout = +14dBm**

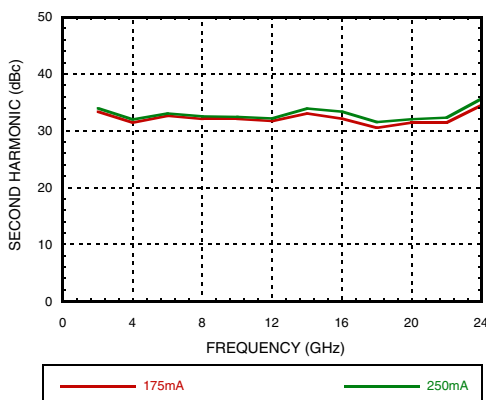

Second Harmonics vs. Pout

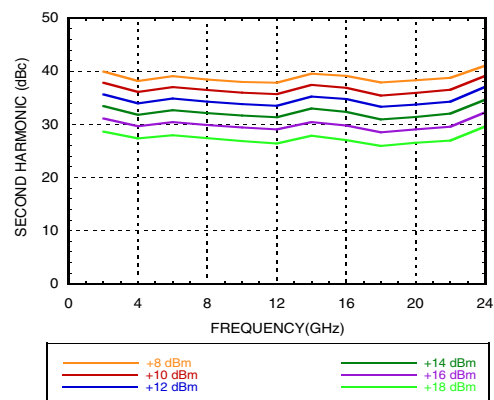

**Low Frequency OIP2 vs. Temperature
@ Pout/tone = +16dBm**

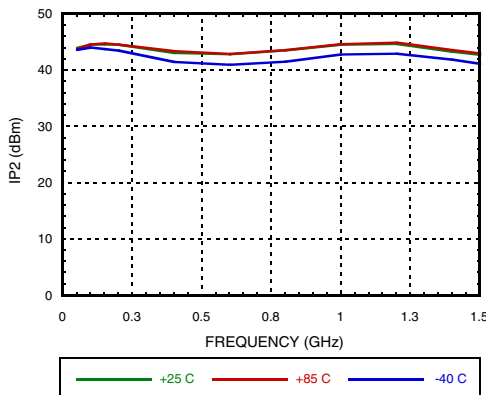

**OIP2 vs Temperature
@ Pout/tone = +16dBm**

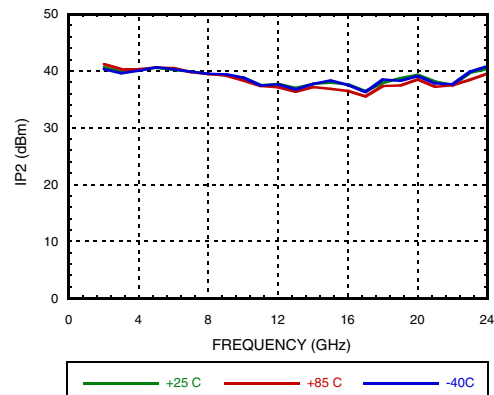

**GaAs pHEMT MMIC
POWER AMPLIFIER, DC - 28 GHz**

OIP2 vs Vdd
@ Pout/tone = +16dBm

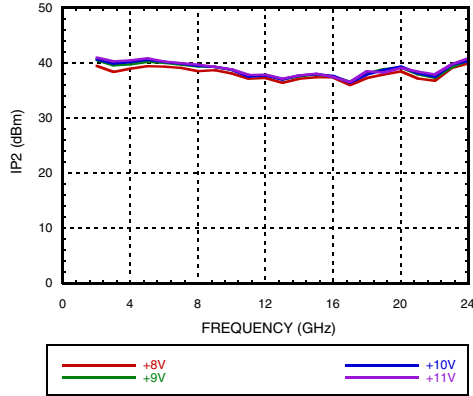

OIP2 vs Idd
@ Pout/tone = +16dBm

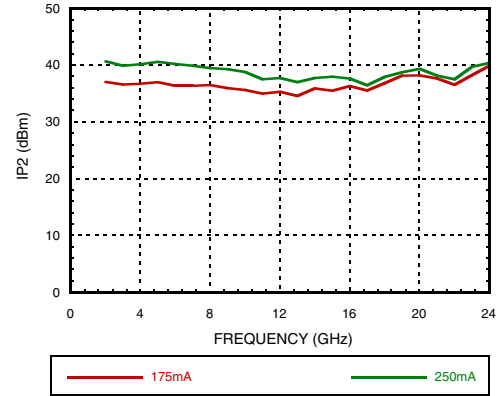

Igg1 vs. Input Power

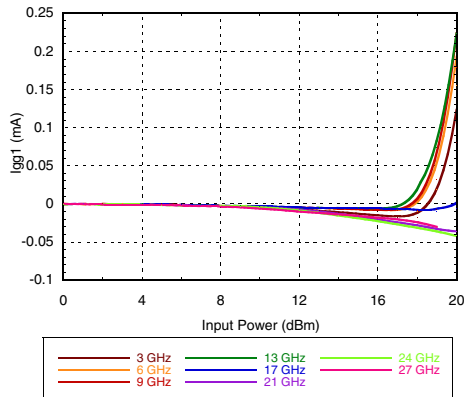

Igg2 vs Input Power

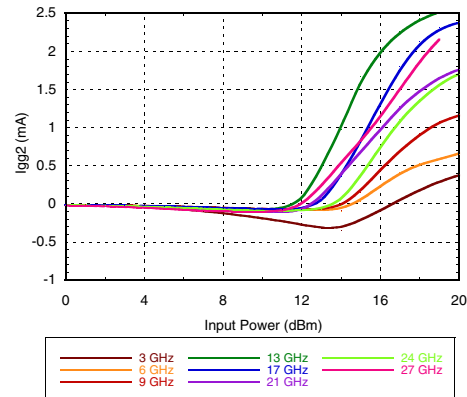

Idd vs Vgg1,
Representative of a Typical Device

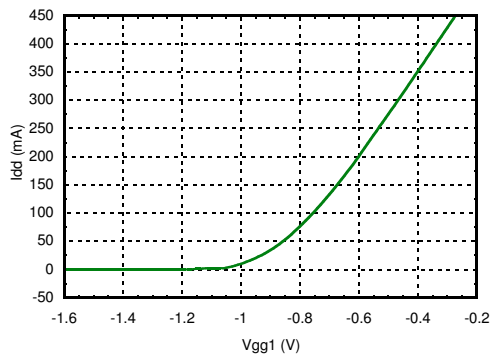

GaAs pHEMT MMIC POWER AMPLIFIER, DC - 28 GHz

Absolute Maximum Ratings

Drain Bias Voltage (Vdd)	+12 Vdc
Gate Bias Voltage (Vgg1)	-3 to 0 Vdc
Gate Bias Voltage (Vgg2)	2.5V min up to (Vdd - 5.5V)
RF Input Power (RFIN)	+25 dBm
Continuous Pdiss (T= 85 °C) (derate 38.9 mW/°C above 85 °C)	3.5 W
Output Load VSWR	7:1
Storage Temperature	-65 to 150°C
Operating Temperature	-40 to 85 °C
ESD Sensitivity (HBM)	Class 0B, passed 150V.

Reliability Information

Channel Temperature to Maintain 1 Million Hour MTTF	175 °C
Thermal Resistance (channel to ground paddle)	25.7 °C/W



**ELECTROSTATIC SENSITIVE DEVICE
OBSERVE HANDLING PRECAUTIONS**

Stresses at or above those listed under Absolute Maximum Ratings may cause permanent damage to the product. This is a stress rating only, functional operation of the product at these or any other conditions above those indicated in the operational section of this specification is not implied. Operation beyond the maximum operating conditions for extended periods may affect product reliability.

Outline Drawing

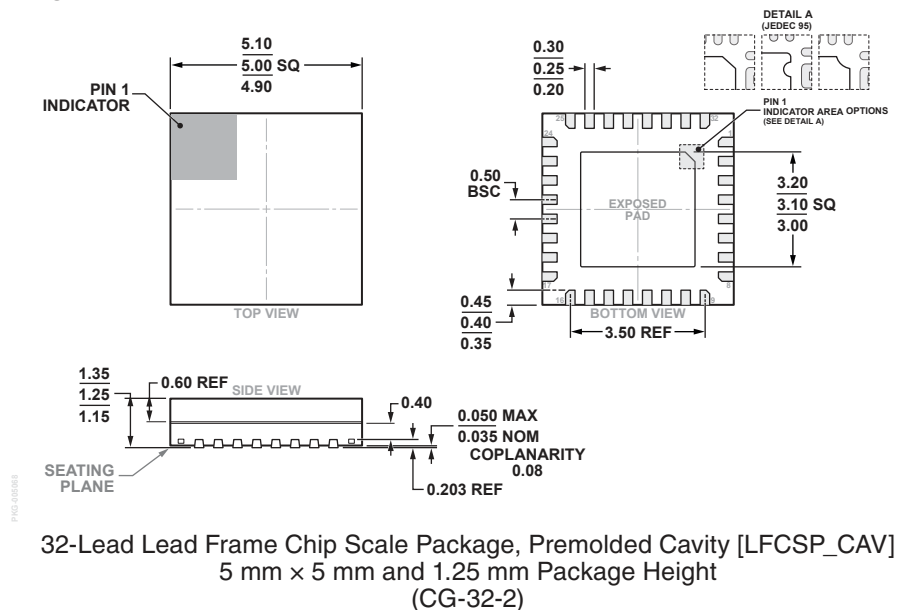

Package Information

Part Number	Package Body Material	Lead Finish	MSL Rating ^[1]	Package Marking
HMC994APM5E	RoHS-compliant Low Stress Pre-Molded Plastic	NiPdAu	MSL3	HMC994A

[1] Max peak reflow temperature of 260 °C

GaAs pHEMT MMIC POWER AMPLIFIER, DC - 28 GHz

Pin Descriptions

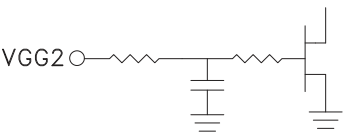
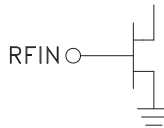
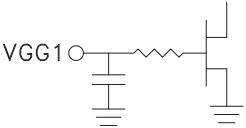
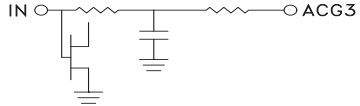
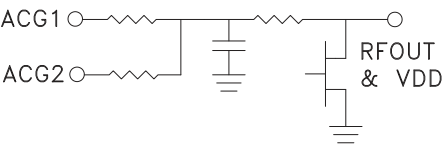
Pin Number	Function	Description	Interface Schematic
1, 4, 6, 8, 9, 14, 16, 17, 20, 22, 24, 25, 32 Package Bottom	GND	These pins & exposed ground paddle must be connected to RF/DC ground.	
2	VGG2	Gate control 2 for amplifier. Attach bypass capacitor per application circuit herein. For nominal operation +3.5V should be applied to Vgg2	
3, 7, 10, 11, 12, 18, 19, 23, 26, 27, 28, 31	N/C	No connection required. These pins may be connected to RF/DC ground without affecting performance.	
5	RFIN	This pin is DC coupled and matched to 50 Ohms. Blocking capacitor is required.	
13	Vgg1	Gate control 1 for amplifier. Attach bypass capacitor per application circuit herein. Please follow "MMIC Amplifier Biasing Procedure" application note.	
15	ACG3	Low Frequency termination. Attach bypass capacitor per application circuit herein.	
21	RFOUT & Vdd	RF output for amplifier. Connect DC bias (Vdd) network to provide drain current (Idd). See application circuit herein.	
29	ACG2	Low frequency termination. Attach bypass capacitor per application circuit herein	
30	ACG1		

GaAs pHEMT MMIC POWER AMPLIFIER, DC - 28 GHz

Evaluation PCB

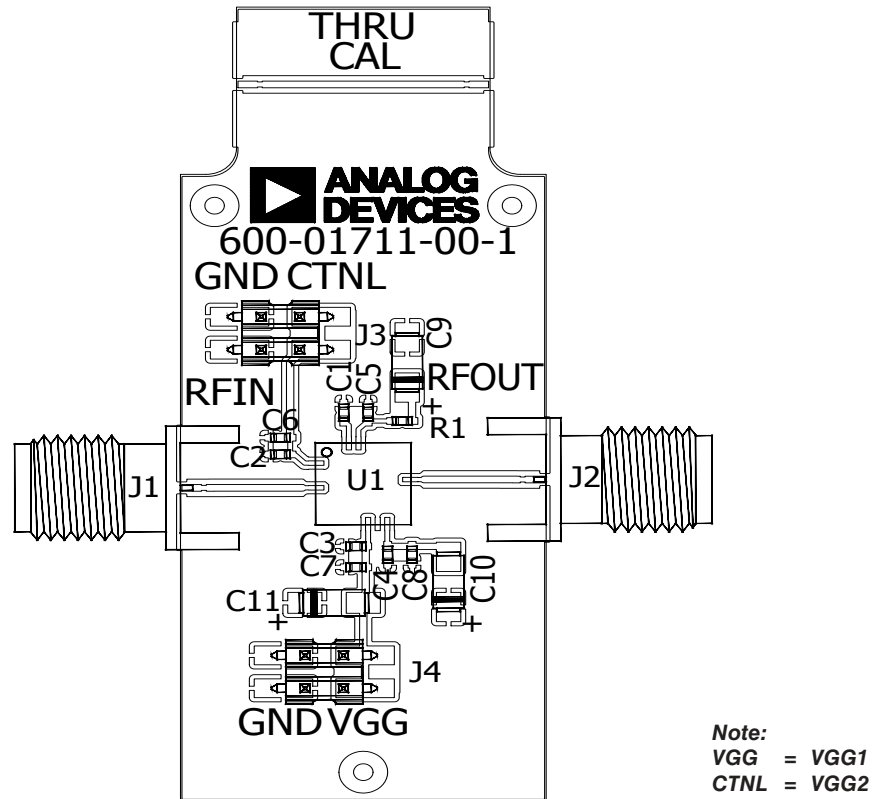

Evaluation Order Information

Item	Contents	Part Number
Evaluation PCB Only	HMC994APM5E Evaluation PCB	EV1HMC994APM5 ^[1]

[1] Reference this number when ordering Evaluation PCB Only

List of Materials for Evaluation Board EV1HMC994APM5

Item	Description
J1, J2	PCB Mount K Connector
J3, J4	DC Pins Connector
C1 - C4	100 pF Capacitor, 0402 Pkg.
C5 - C8	0.01uF Capacitor, 0402 Pkg.
C9 - C11	4.7 uF Capacitor, Tantalum.
R1	0 Ohm Resistor, 0402 Pkg.
U1	HMC994APM5E
PCB ^[1]	600-01711-00 Evaluation PCB.

[1] Circuit Board Material: Rogers 4350 or Arlon 25FR

The circuit board used in the application should use RF circuit design techniques. Signal lines should have 50 Ohm impedance while the package ground leads and exposed paddle should be connected directly to the ground plane similar to that shown. A sufficient number of via holes should be used to connect the top and bottom ground planes. The evaluation circuit board shown is available from Analog Devices upon request.

**GaAs pHEMT MMIC
POWER AMPLIFIER, DC - 28 GHz**

Application Circuit

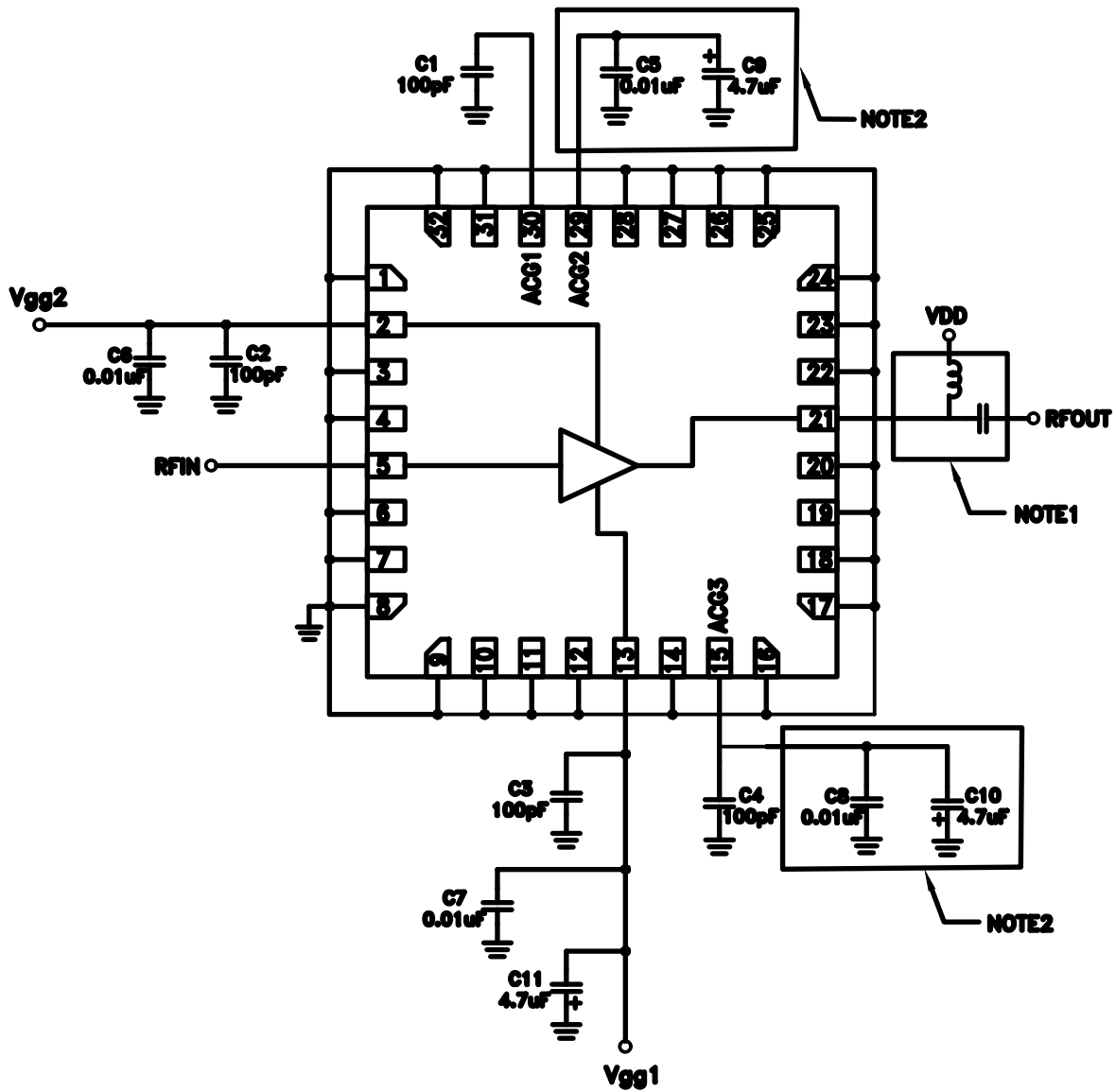

NOTE 1: Drain Bias (Vdd) must be applied through a broadband bias tee or external bias network.
NOTE 2: Optional capacitors to be used if part is to be operated below 200MHz.

**GaAs pHEMT MMIC
POWER AMPLIFIER, DC - 28 GHz****Notes**