

TAS3108EVM2 User's Guide

***Evaluation Module for the
TAS3108 Digital Audio Signal Processor***

User's Guide

TAS3108EVM2 User's Guide

***Evaluation Module for the
TAS3108 Digital Audio Signal Processor***

User's Guide

Literature Number: SLEU065A
SEPTEMBER 2005–Revised NOVEMBER 2006



Preface	5
1 Overview	7
1.1 TAS3108EVM2 System Features	8
1.2 PCB Key Map	9
1.3 Input Board	10
1.4 Output Board	11
2 Quick Setup Guide	13
2.1 Electrostatic Discharge Warning	14
2.2 Unpacking the EVM	14
2.3 Power Supply Setup	15
2.4 Digital Audio Inputs/Outputs	15
2.5 Master/Slave Mode	15
2.6 TAS3108 Software Installation	16
3 System Interfaces	17
3.1 Control Interface (J11), Input	18
3.2 Digital Audio Interface, Input (J12)	19
3.3 Control Interface, Output (J21)	20
3.4 Digital Audio Interface, output (J22)	21
3.5 Connectors on the Input-USB board	21
3.5.1 Analog Inputs	21
3.5.2 SPDIF Coax	22
3.5.3 AP PSIA Interface	22
3.5.4 I2C Connector (J301)	24
3.5.5 Control Interface (J800)	24
3.6 Connectors on the DAC8-DIT2 Board	25
3.6.1 Analog Outputs	25
3.6.2 3.6.2 SPDIF Coax	26
Important Notices	27

List of Figures

1-1	TAS3108EVM2 System	8
1-2	Physical Structure for the TAS3108EVM2 (Rough Outline).....	9
1-3	Input Board Outline	10
1-4	Physical Structure for Output DAC8-DIT2 Board Outline	11
1-5	Complete System	12
2-1	TAS3108 GDE Window	16
3-1	J200... J203 Pin Pumbers	21
3-2	J140 Pin Numbers	22
3-3	AP PSIA Default Setting.....	22
3-4	AP PSIA Settings Using External I2S Source	23
3-5	AP PSIA Interface Pin Numbers	23
3-6	J301 Pin Numbers	24
3-7	J71 to J74 Pin Numbers.....	25
3-8	J62 Pin Numbers	26

List of Tables

1	Related Documentation from Texas Instruments.....	6
2-1	Recommended Supply Voltages for DAC8DIT2 Board	15
3-1	J11 Pin Description	18
3-2	J12 Pin Description	19
3-3	J21 Pin Description	20
3-4	J22 Pin Description	21
3-5	J200 Pin Description (Similar for J201 to J203).....	21
3-6	J140 Pin Description	22
3-7	AP PSIA Pin Description	23
3-8	J301 Pin Description	24
3-9	J800 Pin Description	24
3-10	J71 Pin Description	25
3-11	J62 Pin Description	26

Read This First

About This Manual

This manual describes the operation of the TAS3108EVM2 evaluation module from Texas Instruments.

How to Use this Manual

This document contains the following chapters:

Chapter 1 - Overview

Chapter 2 - Quick Setup Guide

Chapter 3 - System Interfaces

Information About Cautions and Warnings

This manual may contain cautions and warnings.

This is an example of a caution statement.

A caution statement describes a situation that could potentially damage your software or equipment.

CAUTION

This is an example of a warning statement.

A warning statement describes a situation that could potentially cause harm to you.

WARNING

The information in a caution or a warning is provided for your protection. Please read each caution and warning carefully.

Related Documentation from Texas Instruments

The following table contains a list of data manuals that have detailed descriptions of the integrated circuits used in the design of the TAS3108EVM2. The data manuals can be obtained at the URL <http://www.ti.com>.

Table 1. Related Documentation from Texas Instruments

PART NUMBER	LITERATURE NUMBER
TAS3108	SLES152
TLV1117-33	SLVS561
TPS3825-33	SLVS165

Additional Documentation

1. TAS3108EVM2 Application Report
2. Graphical Development tool (GDE) for TAS3108 (GDE version 1.11 or later)
3. General Application Notes

Trademarks

PurePath Digital is a trademark of Texas Instruments.

All other trademarks are the property of their respective owners.

Overview

The TAS3108EVM2 PurePath Digital™ customer evaluation amplifier module demonstrates the digital audio processor TAS3108/TAS3108IA from Texas Instruments (TI).

TAS3108DCP/TAS3108IADCP is a fully programmable high-performance audio processor. It uses an efficient, custom, multi-instruction programming environment optimized for digital audio processing algorithms. The TAS3108/TAS3108IA architecture provides high-quality audio processing by using a 48-bit data path, 28-bit filter coefficients, and a single-cycle 28×48 -bit multiplier with a 76-bit accumulator. An embedded 8051 microprocessor provides algorithm and data control for the TAS3108/TAS3108IA. The TAS3108 is the commercial version, intended for home audio and other commercial applications. The TAS3108IA is the automotive version that is qualified for use in automotive applications. This EVM uses the TAS3108 version, and the active/passive parts used are not qualified for automotive use.

This EVM is delivered together with two boards: an input board with SPDIF, ACD, and USB for PC control, and an output board with DACs and a SPDIF transmitter. This system is a complete eight-channel digital audio processor system that includes digital input/output (S/PDIF), analog inputs/outputs, interface to PC, and DAP features like digital volume control, input and output mixers, auto mute, equalization, tone controls, loudness, dynamic range compression, and surround effects.

The TAS3108 applications could be automotive sound systems, digital televisions, home theater systems, mini-component audio systems, and pro-audio.

Replacing the DAC-DIT output board with one of the TI PurePath digital-amplifier EVMs makes it possible to test the TAS3108 with a speaker connected directly. Examples of EVMs that can be connected include, but are not limited to, TAS5508-5142K7EVM, TAS5518-5152K8EVM, TAS5518-5182C8EVM2, and TAS5086-5186V6EVM. This system is designed for home theater applications such as A/V receivers, DVD mini-component systems, home theater in a box (HTIB), DVD receivers, or plasma display panels (PDP).

Topic	Page
1.1 TAS3108EVM2 System Features	8
1.2 PCB Key Map	9
1.3 Input Board	10
1.4 Output Board	11

1.1 TAS3108EVM2 System Features

- Socketed EEPROM for download of program and coefficients
- Eight-channel analog-to-digital converter, four PCM1802 devices, 102-dB DYR A-weighted
- Eight-channel digital-to-analog converter, two PCM4104 devices, 116-dB DYR A-weighted
- Two-channel SPDIF receiver, coaxial and optical input
- Two-channel SPDIF transmitter, coaxial and optical output
- I2S input and output connectors
- USB-to-PC connection for software control
- Double-sided plated-through PCB layout

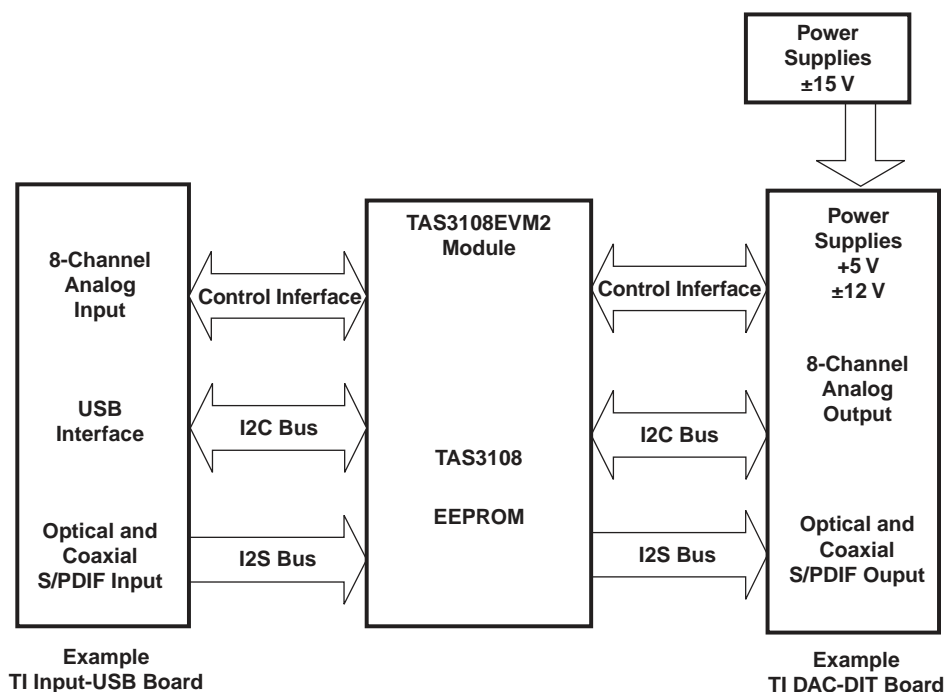

Figure 1-1. TAS3108EVM2 System

1.2 PCB Key Map

Physical structure for the TAS3108EVM2 is illustrated in [Figure 1-2](#).

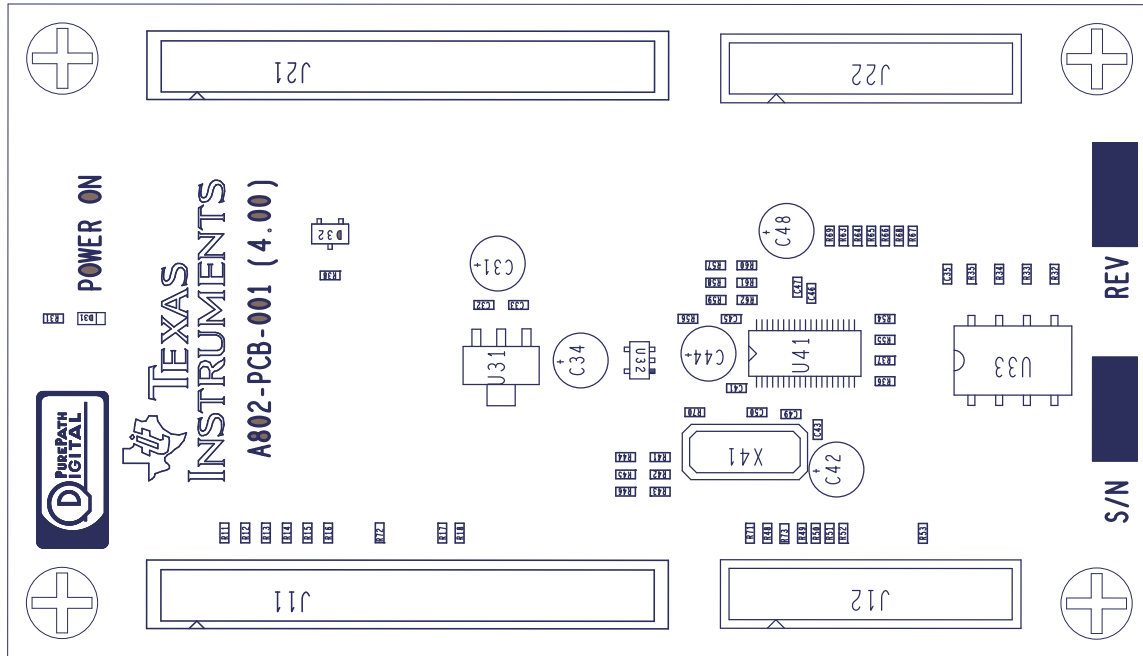

Figure 1-2. Physical Structure for the TAS3108EVM2 (Rough Outline)

U41 is the TAS3108 device. U33 is the EEPROM for program and coefficient storage. Digital audio data (I2S) is input on J12 and output on J22. J11 is used for I2C control, reset signal, and power-supply voltage. Signals in J11 are duplicated in J21 for further control of a DAC output board or speaker amplifier.

D31, a green LED, indicates that the power-supply voltage is within specifications and that the device is brought out of reset.

1.3 Input Board

The input board contains an eight-channel ADC, SPDIF receiver, and USB connection. Buttons for MUTE, RESET, and selection between 48-kHz and 96-kHz sample rate.

Physical structure for the input-USB board is illustrated in [Figure 1-3](#).

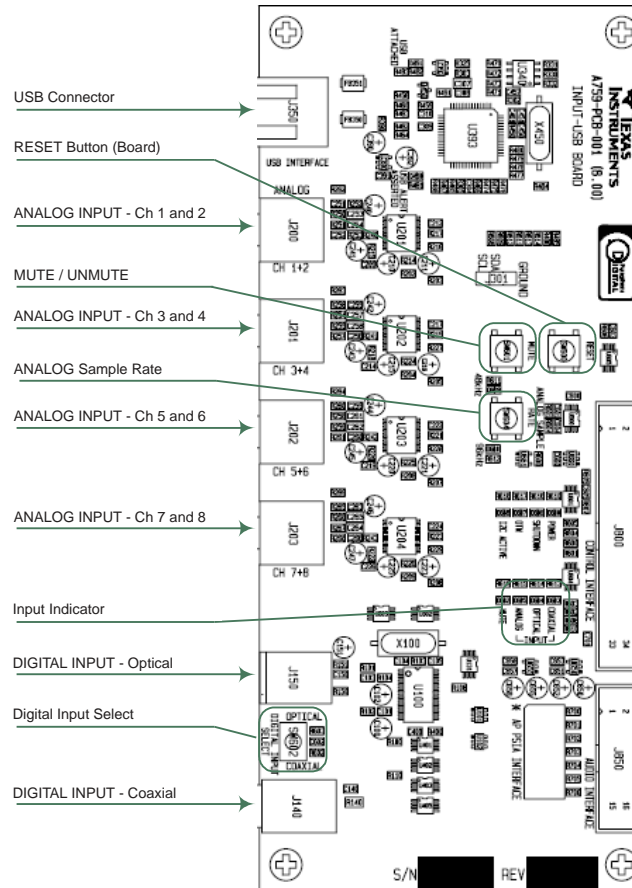

Figure 1-3. Input Board Outline

1.4 Output Board

- Eight-channel digital-to-analog converter, two PCM4104 devices, automatic sample-rate detection, and supports 44.1 kHz, 48 kHz, and 96 kHz in this application. Relation between master clock and sample rate clock must be 256. 4-Vrms for 0-dB and 116-dB DYR A-weighted.
- Two-channel digital audio output, SPDIF format, DIT4192, optical and electrical output
- ± 12 -V and 5-V power-supply regulators

The physical structure of the output DAC8-DIT2 board is illustrated in [Figure 1-4](#).

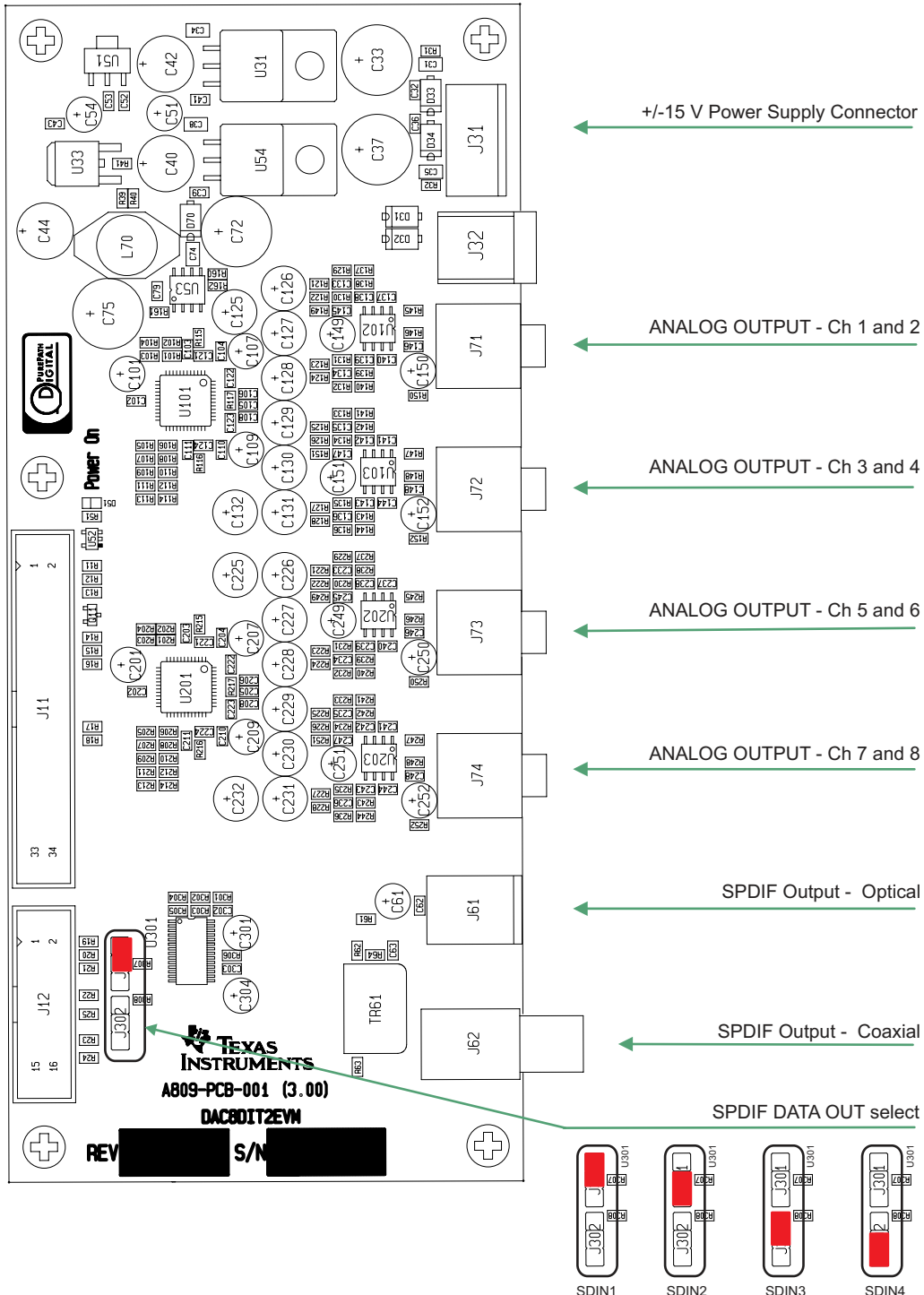

Figure 1-4. Physical Structure for Output DAC8-DIT2 Board Outline

Output Board

A picture of the complete system is shown in [Figure 1-5](#). The input board is to the left, the TAS3108EVM2 is in the middle, and the output board is to the right.

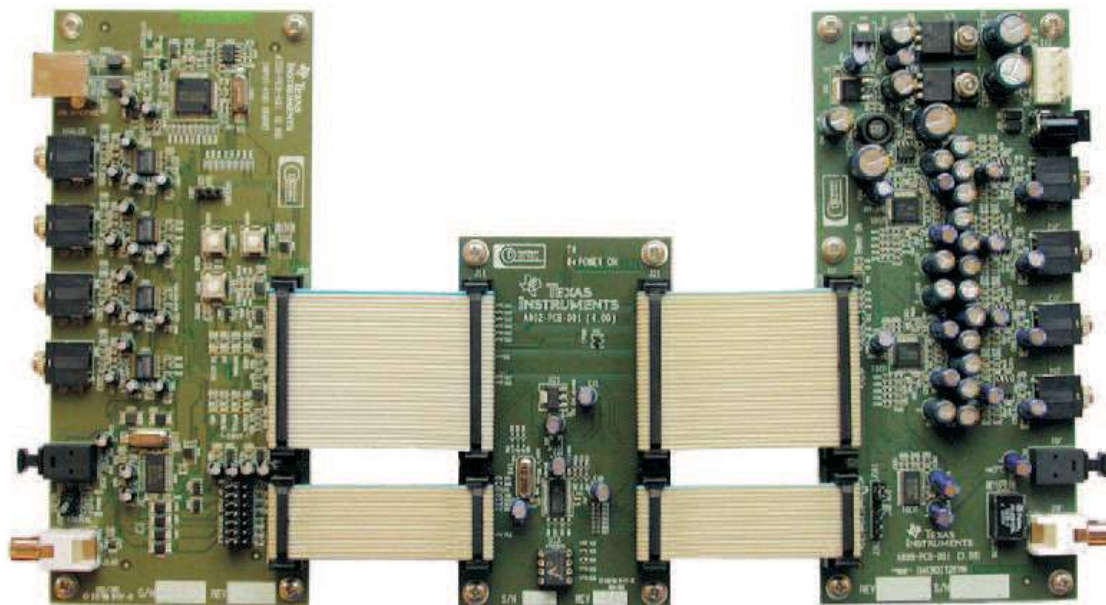

Figure 1-5. Complete System

Quick Setup Guide

This chapter describes the TAS3108EVM2 board, with regard to power supplies and system interfaces. The chapter provides information regarding handling and unpacking, absolute operating conditions, and a description of the factory default switch and jumper configuration.

This chapter provides a step-by-step guide to configuring the TAS3108EVM2 for device evaluation.

Topic	Page
2.1 Electrostatic Discharge Warning	14
2.2 Unpacking the EVM	14
2.3 Power Supply Setup	15
2.4 Digital Audio Inputs/Outputs	15
2.5 Master/Slave Mode	15
2.6 TAS3108 Software Installation	16

2.1 Electrostatic Discharge Warning

Many of the components on the TAS3108EVM2 are susceptible to damage by electrostatic discharge (ESD). Customers are advised to observe proper ESD handling precautions when unpacking and handling the EVM, including the use of a grounded wrist strap at an approved ESD workstation.

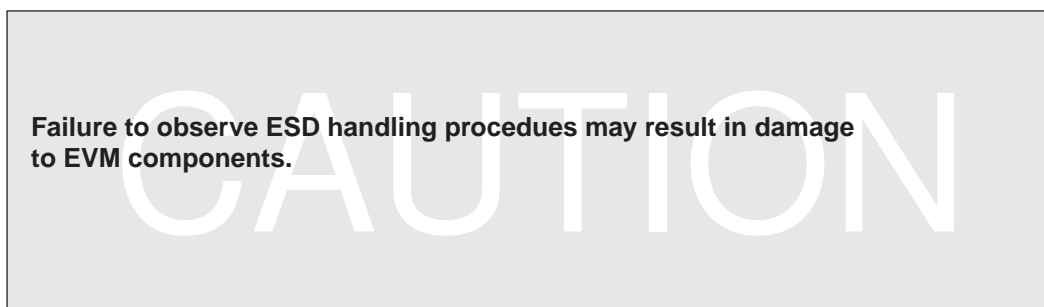

2.2 Unpacking the EVM

Upon opening the TAS3108EVM2 package, please ensure that the following items are included:

- One TAS3108EVM2 board using one TAS3108DCP
- One TI input-USB board for interfacing TAS3108EVM2 with SPDIF receiver and eight-channel analog-to-digital converter and USB for PC control
- One TI DAC8-DIT2 board for interfacing TAS3108EVM2 with SPDIF transmitter and digital-to-analog converter outputs and power-supply regulators
- Two signal interface IDC cables for connection to an I2S back-end like the attached TI DAC8-DIT2 board, 14 pin
- Two control interface IDC cables for connection to an I2C back-end like the attached TI DAC8-DIT2 board, 34 pin
- One cable for connecting input-USB board to a USB port on a PC for TAS3108 control by software
- One cable for connecting DAC8-DIT2 board to the power supplies
- One PurePath CD-ROM containing data sheets, application notes, user's guides, gerber files, and PC software tools

If any of these items are missing, please contact the Texas Instruments Product Information Center nearest you to obtain a replacement.

Connect the input-USB board to TAS3108EVM2 using the two included delivered IDC cables. Connect TAS3108EVM2 board to DAC8-DIT2 board using the two included IDC cables.

2.3 Power Supply Setup

The TAS3108EVM2 is powered via the DAC8-DIT2 board or another output board, like a TAS5086-5186EVM. The DAC8-DIT2 board generates a +5-V supply that is fed to the TAS3108EVM2. The +5-V supply is further regulated to +3.3 V with the aid of a low-dropout linear regulator, U31.

Set the power supplies to ± 15 V, switch off the power supply, connect all cables to the EVM, and switch on the power supply. Current consumption should be less than is shown in [Table 2-1](#). If it is higher, switch off the power supply and double check the cabling.

Table 2-1. Recommended Supply Voltages for DAC8DIT2 Board

DESCRIPTION	VOLTAGE LIMITATIONS	CURRENT REQUIREMENT	CABLE
+15 V	+14.5 V to +15.5 V	0.3 A	J31 pin 2
-15 V	-15.5 V to -14.4V	0.1 A	J31 pin 1

**Applying voltages above the limitations given in the table above
 may cause permanent damage to your hardware.**

2.4 Digital Audio Inputs/Outputs

The digital audio inputs can be connected to the board in two ways, either in the SPDIF format on the coaxial connector or optical TosLink input or in I2S format on connector J12. The pinouts are shown in [Section 3.5](#) and [Section 3.6](#).

The digital audio outputs can be both SPDIF and I2S. SPDIF format is output on the coaxial connector (J62) or optical TosLink® connector (J61), or I2S format is output on connector J22. Jumpers J301 and J302 select the SDATA line to feed to the SPDIF transmitter.

2.5 Master/Slave Mode

The TAS3108EVM2 is delivered in Slave mode.

The SPDIF receiver, on the input board, is the MCLK clock master in this system.

The digital audio outputs can be both SPDIF and I2S. SPDIF format is output on coaxial connector, J62, or optical TosLink, J61, or in I2S format on connector J22. Jumpers J301 and J302 selects the SDATA line to feed to the SPDIF transmitter.

After each reset, either auto-generated during power-up sequence or manual pressing RESET button, the input-USB board is always in the following configuration:

- Mute enabled
- Analog input set to 48-kHz sample rate

To start up a PurePath EVM, use following procedure:

1. Turn on all power supplies before connecting USB interface.
2. Connect USB interface and press RESET button.
3. Start GUI software and press RESET in GUI window. Make sure that the "USB attached" LED is on and that the status indicator changes to "OK".
4. Load EVM configuration file. Ensure that the correct file is selected, according to the EVM in use.
5. Press MUTE to unmute the EVM.
6. The EVM is now ready to use.

2.6 TAS3108 Software Installation

The TAS3108 GDE and IDE software provide easy programming of the TAS3108 and enable programming of the EEPROM on the EVM board.

1. Insert the PurePath CD-ROM
 - If it does not autorun, run the ReadMe file.
 - Select "SOFTWARE" in the menu to the left.
 - Select the TAS3108 tools, and follow the instructions given to install.
2. After installation, turn on power supplies and connect USB cable to input-USB board.
3. Start GDE program from the Windows Start menu. Startup of GDE requires a few seconds.

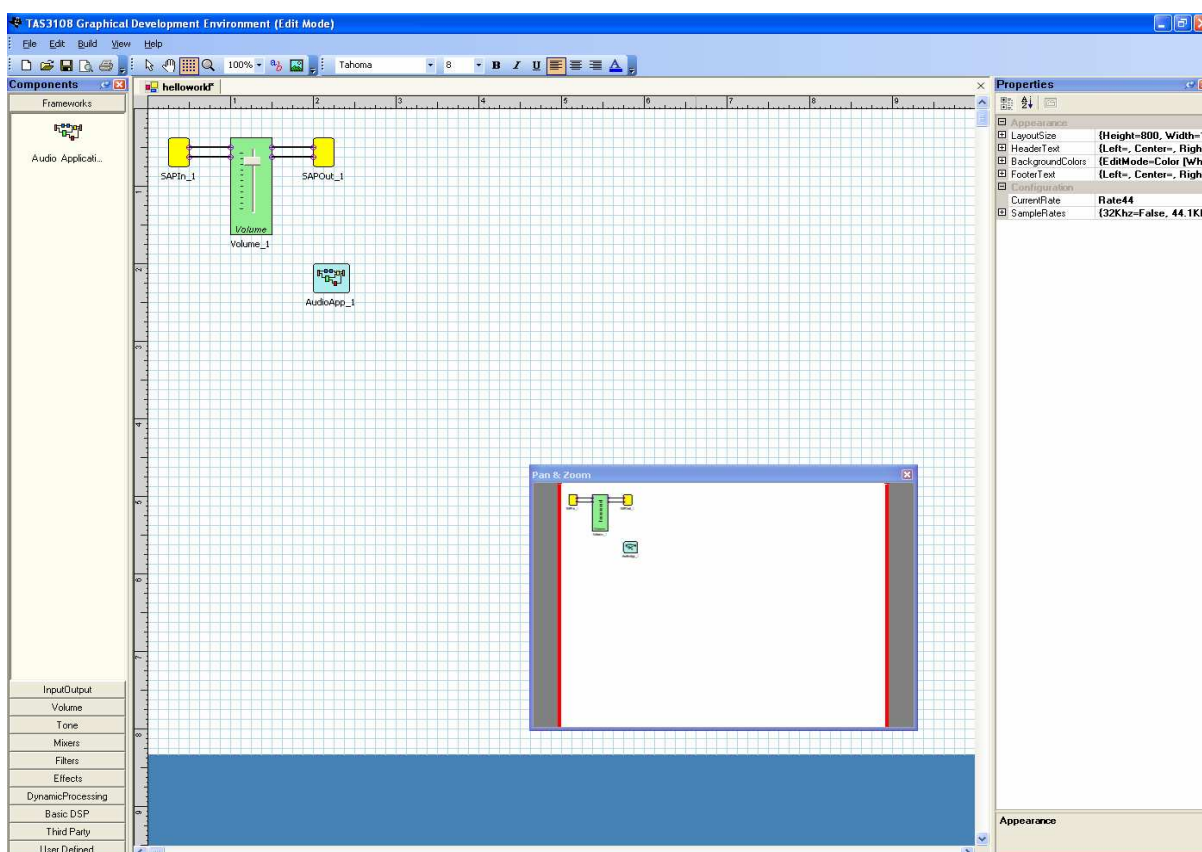

Figure 2-1. TAS3108 GDE Window

To test the connection from PC to EVM, load the TAS3108EVM2 test file (helloworld.pfw), located in C:\Program Files\Texas Instruments Inc\TAS3108 Development Tools\Examples\HelloWorld.pfw.

For more advanced use of the GDE, see the GDE online help, GDE release notes, and TAS3108 MCU programmer's reference guide.

System Interfaces

This chapter describes the TAS3108EVM2 board regard to power supplies and system interfaces.

Topic	Page
3.1 Control Interface (J11), Input	18
3.2 Digital Audio Interface, Input (J12)	19
3.3 Control Interface, Output (J21).....	20
3.4 Digital Audio Interface, output (J22)	21
3.5 Connectors on the Input-USB board.....	21
3.6 Connectors on the DAC8-DIT2 Board	25

3.1 Control Interface (J11), Input

This interface connects the TAS3108EVM2 board to a TI input-USB board. This is a general-purpose interface, so not all signals are used by the TAS3108. Unused signals are shaded in [Table 3-1](#).

Table 3-1. J11 Pin Description

PIN NO.	NET-NAME AT SCHEMATICS	DESCRIPTION
1	GND	Ground
2	RESERVED	
3	GND	Ground
4	RESET	System reset (bidirectional). Activate MUTE before RESET for quiet reset.
5	RESERVED	
6	MUTE	Ramp volume from any setting to noiseless soft mute. Mute can also be activated by I2C.
7	PDN	Power down. TAS3108 goes into power down state when activated.
8	RESERVED	
9	RESERVED	
10	SDA	I2C data clock
11	GND	Ground
12	SCL	I2C bit clock
13	GPIO1	
14	GPIO2	
15	GPIO3	
16	GPIO4	General-purpose input/output 4, used to reset the TAS3108 after programming.
17	GND	Ground
18	GPIO5	
19	GPIO6	
20	SD	Shutdown reporting. Used for speaker-output EVMs.
21	RESERVED	
22	OTW	Temperature warning. Used for speaker-output EVMs.
23	RESERVED	
24	RESERVED	
25	GND	Ground
26	GND	Ground
27	RESERVED	
28	RESERVED	
29	RESERVED	
30	RESERVED	
31	GND	Ground
32	GND	Ground
33	+5V	+5-Vdc power supply (output)
34	+5V	+5-Vdc power supply (output)

3.2 Digital Audio Interface, Input (J12)

The digital audio interface contains digital audio signal data (I2S), clocks, etc. See the TAS3108 data manual for signal timing and details not covered in this document.

Table 3-2. J12 Pin Description

PIN NUMBER	NET-NAME AT SCHEMATICS	DESCRIPTION
1	GND	Ground
2	MCLK	Master clock input
3	GND	Ground
4	SDIN1	I2S data 1, Channel 1 and 2
5	SDIN2	I2S data 2, Channel 3 and 4
6	SDIN3	I2S data 3, Channel 5 and 6
7	SDIN4	I2S data 4, Channel 7 and 8
8		Reserved
9		Reserved
10	GND	Ground
11	SCLK	I2S bit clock
12	GND	Ground
13	LRCLK	I2S left-right clock
14	GND	Ground
15		Reserved
16	GND	Ground

3.3 Control Interface, Output (J21)

This interface connects the TAS3108EVM2 board to a TI DAC8-DIT2 output board or a general amplifier power EVM. This is a general-purpose interface, so not all signals are used by the TAS3108. Unused signals are shaded in [Table 3-3](#).

Table 3-3. J21 Pin Description

PIN NO.	NET-NAME AT SCHEMATICS	DESCRIPTION
1	GND	Ground
2	RESERVED	
3	GND	Ground
4	RESET	System reset (bidirectional). Activate $\overline{\text{MUTE}}$ before $\overline{\text{RESET}}$ for quiet reset.
5	RESERVED	
6	$\overline{\text{MUTE}}$	Ramp volume from any setting to noiseless soft mute. Mute can also be activated by I2C.
7	$\overline{\text{PDN}}$	Power down. TAS3108 goes into power down state when activated.
8	RESERVED	
9	RESERVED	
10	SDA	I2C data clock
11	GND	Ground
12	SCL	I2C bit clock
13	GPIO1	
14	GPIO2	
15	GPIO3	
16	GPIO4	General-purpose input/output 4, used to reset the TAS3108 after programming.
17	GND	Ground
18	GPIO5	
19	GPIO6	
20	$\overline{\text{SD}}$	Shutdown reporting. Used for speaker output EVMs.
21	RESERVED	
22	$\overline{\text{OTW}}$	Temperature warning. Used for speaker output EVMs.
23	RESERVED	
24	RESERVED	
25	GND	Ground
26	GND	Ground
27	RESERVED	
28	RESERVED	
29	RESERVED	
30	RESERVED	
31	GND	Ground
32	GND	Ground
33	+5V	+5-Vdc power supply (output)
34	+5V	+5-Vdc power supply (output)

3.4 Digital Audio Interface, output (J22)

The digital audio interface contains digital audio signal data (I2S), clocks, etc. See the TAS3108 data manual for signal timing and details not covered in this document.

Table 3-4. J22 Pin Description

PIN NO.	NET-NAME AT SCHEMATICS	DESCRIPTION
1	GND	Ground
2	MCLKO	Master clock output
3	GND	Ground
4	SDOUT1	I2S data 1, channels 1 and 2
5	SDOUT2	I2S data 2, channels 3 and 4
6	SDOUT3	I2S data 3, channels 5 and 6
7	SDOUT4	I2S data 4, channels 7 and 8
8		Reserved
9		Reserved
10	GND	Ground
11	SCLKOUT	I2S bit clock output
12	GND	Ground
13	LRCLKO	I2S left-right clock output
14	GND	Ground
15		Reserved
16	GND	Ground

3.5 Connectors on the Input-USB board

3.5.1 Analog Inputs

The mini-jack 3.5-mm connector for analog inputs is shown in [Figure 3-1](#).

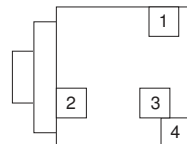

PCB Connector (Top View)

Figure 3-1. J200... J203 Pin Puffers

Table 3-5. J200 Pin Description (Similar for J201 to J203)

PIN NO.	NET-NAME AT SCHEMATICS	DESCRIPTION
1	CH1	Channel 1 input – tip
2	AGND	Analog ground – sleeve
3		For future use
4	CH2	Channel 2 input – ring

3.5.2 SPDIF Coax

The SPDIF input for coax is shown in [Figure 3-2](#).

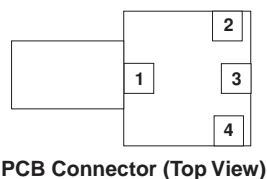

Figure 3-2. J140 Pin Numbers

Table 3-6. J140 Pin Description

PIN NO.	NET-NAME AT SCHEMATICS	DESCRIPTION
1	GND	Ground
2	IN1	Coax SPDIF input
3	IN1	Coax SPDIF input
4	IN1	Coax SPDIF input

3.5.3 AP PSIA Interface

The input-USB board provides the ability to input I2S directly into the PurePath EVM. I2S source could be, for example, an Audio Precision with a Programmable Serial Interface Adaptor (PSIA).

Default jumper settings are shown in [Figure 3-3](#). In this setting, data out is: analog channels 1 and 2 routed to Data1, analog channels 3 and 4 to Data2, etc., when analog inputs are selected. When digital input is selected, either coax or TosLink channel A+B is copied into all data outputs.

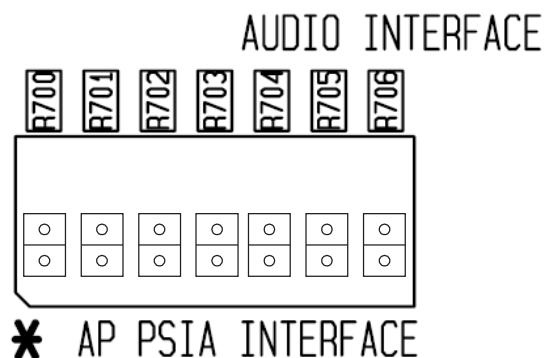

Figure 3-3. AP PSIA Default Setting

When using the input-USB board with an external I2S source connection, the jumper settings in [Figure 3-4](#) should be used. Placing the jumper as shown copies I2S data into all data outputs.

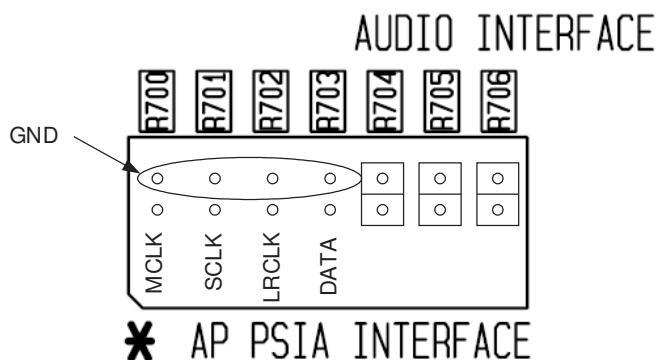

Figure 3-4. AP PSIA Settings Using External I2S Source

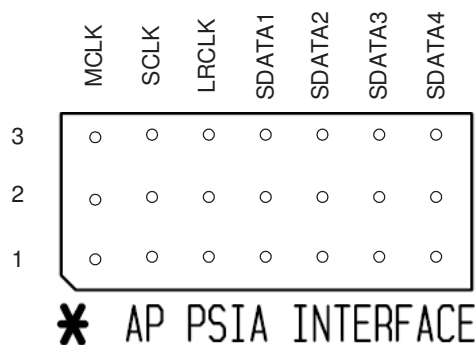

Figure 3-5. AP PSIA Interface Pin Numbers

Table 3-7. AP PSIA Pin Description

PIN NO.	NET-NAME AT SCHEMATICS	DESCRIPTION
MCLK	1 MCLK Source	From MCLK source
	2 MCLK Out	MCLK output
	3 GND	Ground
SCLK	1 SCLK Source	From SCLK source
	2 SCLK Out	SCLK output
	3 GND	Ground
LRCLK	1 LRCLK Source	From LRCLK source
	2 LRCLK Out	LRCLK output
	3 GND	Ground
SDATA1	1 SDATA1 Source	From SPDIF or analog channels 1 and 2
	2 SDATA1 Out	SDATA1 output
	3 GND	Ground
SDATA2	1 SDATA2 Source	From SPDIF or analog channels 3 and 4
	2 SDATA2 Out	SDATA2 output
	3 SDATA1 Out	Connected to SDATA1 Out
SDATA3	1 SDATA3 Source	From SPDIF or analog channels 5 and 6
	2 SDATA3 Out	SDATA3 output
	3 SDATA1 Out	Connected to SDATA1 Out

Table 3-7. AP PSIA Pin Description (continued)

PIN NO.	NET-NAME AT SCHEMATICS	DESCRIPTION
SDATA4 1	SDATA4 Source	From SPDIF or analog channels 7 and 8
2	SDATA4 Out	SDATA4 output
3	SDATA1 Out	Connected to SDATA1 Out

3.5.4 I2C Connector (J301)

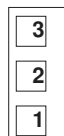

PCB Connector (Top View)

Figure 3-6. J301 Pin Numbers
Table 3-8. J301 Pin Description

PIN NO.	NET-NAME AT SCHEMATICS	DESCRIPTION
1	SCL	I2C clock
2	SDA	I2C data
3	GND	Ground

3.5.5 Control Interface (J800)

This interface connects the EVM.

Table 3-9. J800 Pin Description

PIN NO.	NET-NAME AT SCHEMATICS	DESCRIPTION
1	GND	Ground
2	RESERVED	
3	GND	Ground
4	$\overline{\text{RESET}}$	System reset (bidirectional). Activate $\overline{\text{MUTE}}$ before $\overline{\text{RESET}}$ for quiet reset.
5	RESERVED	
6	$\overline{\text{MUTE}}$	Activate $\overline{\text{MUTE}}$ pin on modulator
7	RESERVED	
8	RESERVED	
9	RESERVED	
10	SDA	I2C data clock
11	GND	Ground
12	SCL	I2C bit clock
13	GPIO1	General-purpose port for GUIs
14	GPIO2	General-purpose port for GUIs
15	GPIO3	General-purpose port for GUIs
16	GPIO4	General-purpose port for GUIs
17	GND	Ground
18	GPIO5	General-purpose port for GUIs

Table 3-9. J800 Pin Description (continued)

PIN NO.	NET-NAME AT SCHEMATICS	DESCRIPTION
19	GPIO6	General-purpose port for GUIs
20	$\overline{SD1}$	Shutdown reporting
21	$\overline{SD2}$	Shutdown reporting
22	$\overline{TW1}$	Temperature warning
23	$\overline{TW2}$	Temperature warning
24	RESERVED	
25	GND	Ground
26	GND	Ground
27	RESERVED	
28	RESERVED	
29	RESERVED	
30	RESERVED	
31	GND	Ground
32	GND	Ground
33	+5V	+5-Vdc power supply (output)
34	+5V	+5-Vdc power supply (output)

3.6 Connectors on the DAC8-DIT2 Board

3.6.1 Analog Outputs

The mini-jack 3.5-mm connector for analog outputs is shown in [Figure 3-7](#).

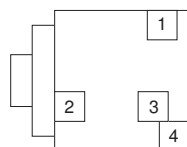

PCB Connector (Top View)

Figure 3-7. J71 to J74 Pin Numbers

Table 3-10. J71 Pin Description

PIN NO.	NET-NAME AT SCHEMATICS	DESCRIPTION
1	CH1	Channel 1, left output – tip
2	AGND	Analog ground – sleeve
3		For future use
4	CH2	Channel 2, right output – ring

3.6.2 3.6.2 SPDIF Coax

The SPDIF input for coax is shown in [Figure 3-8](#).

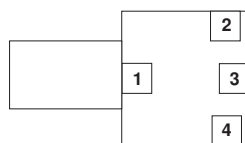

PCB Connector (Top View)

Figure 3-8. J62 Pin Numbers

Table 3-11. J62 Pin Description

PIN NO.	NET-NAME AT SCHEMATICS	DESCRIPTION
1	GND	Ground
2	IN1	Coax SPDIF output
3	IN1	Coax SPDIF output
4	IN1	Coax SPDIF output

EVALUATION BOARD/KIT IMPORTANT NOTICE

Texas Instruments (TI) provides the enclosed product(s) under the following conditions:

This evaluation kit being sold by TI is intended for use for **ENGINEERING DEVELOPMENT OR EVALUATION PURPOSES ONLY** and is not considered by TI to be fit for commercial use. As such, the goods being provided may not be complete in terms of required design-, marketing-, and/or manufacturing-related protective considerations, including product safety measures typically found in the end product incorporating the goods. As a prototype, this product does not fall within the scope of the European Union directive on electromagnetic compatibility and therefore may not meet the technical requirements of the directive.

Should this evaluation kit not meet the specifications indicated in the EVM User's Guide, the kit may be returned within 30 days from the date of delivery for a full refund. **THE FOREGOING WARRANTY IS THE EXCLUSIVE WARRANTY MADE BY SELLER TO BUYER AND IS IN LIEU OF ALL OTHER WARRANTIES, EXPRESSED, IMPLIED, OR STATUTORY, INCLUDING ANY WARRANTY OF MERCHANTABILITY OR FITNESS FOR ANY PARTICULAR PURPOSE.**

The user assumes all responsibility and liability for proper and safe handling of the goods. Further, the user indemnifies TI from all claims arising from the handling or use of the goods. Please be aware that the products received may not be regulatory compliant or agency certified (FCC, UL, CE, etc.). Due to the open construction of the product, it is the user's responsibility to take any and all appropriate precautions with regard to electrostatic discharge.

EXCEPT TO THE EXTENT OF THE INDEMNITY SET FORTH ABOVE, NEITHER PARTY SHALL BE LIABLE TO THE OTHER FOR ANY INDIRECT, SPECIAL, INCIDENTAL, OR CONSEQUENTIAL DAMAGES.

TI currently deals with a variety of customers for products, and therefore our arrangement with the user **is not exclusive.**

TI assumes **no liability for applications assistance, customer product design, software performance, or infringement of patents or services described herein.**

Please read the User's Guide and, specifically, the Warnings and Restrictions notice in the User's Guide prior to handling the product. This notice contains important safety information about temperatures and voltages. For additional information on TI's environmental and/or safety programs, please contact the TI application engineer or visit www.ti.com/esh.

No license is granted under any patent right or other intellectual property right of TI covering or relating to any machine, process, or combination in which such TI products or services might be or are used.

FCC Warning

This evaluation board/kit is intended for use for **ENGINEERING DEVELOPMENT, DEMONSTRATION, OR EVALUATION PURPOSES ONLY** and is not considered by TI to be a finished end-product fit for general consumer use. It generates, uses, and can radiate radio frequency energy and has not been tested for compliance with the limits of computing devices pursuant to part 15 of FCC rules, which are designed to provide reasonable protection against radio frequency interference. Operation of this equipment in other environments may cause interference with radio communications, in which case the user at his own expense will be required to take whatever measures may be required to correct this interference.

EVM WARNINGS AND RESTRICTIONS

It is important to operate this EVM within the range of 5-6V for the system supply.

Exceeding the specified input range may cause unexpected operation and/or irreversible damage to the EVM. If there are questions concerning the input range, please contact a TI field representative prior to connecting the input power.

Applying loads outside of the specified output range may result in unintended operation and/or possible permanent damage to the EVM. Please consult the EVM User's Guide prior to connecting any load to the EVM output. If there is uncertainty as to the load specification, please contact a TI field representative.

During normal operation, some circuit components may have case temperatures greater than 75°C. The EVM is designed to operate properly with certain components above 75°C as long as the input and output ranges are maintained. These components include but are not limited to linear regulators, switching transistors, pass transistors, and current sense resistors. These types of devices can be identified using the EVM schematic located in the EVM User's Guide. When placing measurement probes near these devices during operation, please be aware that these devices may be very warm to the touch.

Mailing Address: Texas Instruments, Post Office Box 655303, Dallas, Texas 75265

IMPORTANT NOTICE

Texas Instruments Incorporated and its subsidiaries (TI) reserve the right to make corrections, modifications, enhancements, improvements, and other changes to its products and services at any time and to discontinue any product or service without notice. Customers should obtain the latest relevant information before placing orders and should verify that such information is current and complete. All products are sold subject to TI's terms and conditions of sale supplied at the time of order acknowledgment.

TI warrants performance of its hardware products to the specifications applicable at the time of sale in accordance with TI's standard warranty. Testing and other quality control techniques are used to the extent TI deems necessary to support this warranty. Except where mandated by government requirements, testing of all parameters of each product is not necessarily performed.

TI assumes no liability for applications assistance or customer product design. Customers are responsible for their products and applications using TI components. To minimize the risks associated with customer products and applications, customers should provide adequate design and operating safeguards.

TI does not warrant or represent that any license, either express or implied, is granted under any TI patent right, copyright, mask work right, or other TI intellectual property right relating to any combination, machine, or process in which TI products or services are used. Information published by TI regarding third-party products or services does not constitute a license from TI to use such products or services or a warranty or endorsement thereof. Use of such information may require a license from a third party under the patents or other intellectual property of the third party, or a license from TI under the patents or other intellectual property of TI.

Reproduction of information in TI data books or data sheets is permissible only if reproduction is without alteration and is accompanied by all associated warranties, conditions, limitations, and notices. Reproduction of this information with alteration is an unfair and deceptive business practice. TI is not responsible or liable for such altered documentation.

Resale of TI products or services with statements different from or beyond the parameters stated by TI for that product or service voids all express and any implied warranties for the associated TI product or service and is an unfair and deceptive business practice. TI is not responsible or liable for any such statements.

TI products are not authorized for use in safety-critical applications (such as life support) where a failure of the TI product would reasonably be expected to cause severe personal injury or death, unless officers of the parties have executed an agreement specifically governing such use. Buyers represent that they have all necessary expertise in the safety and regulatory ramifications of their applications, and acknowledge and agree that they are solely responsible for all legal, regulatory and safety-related requirements concerning their products and any use of TI products in such safety-critical applications, notwithstanding any applications-related information or support that may be provided by TI. Further, Buyers must fully indemnify TI and its representatives against any damages arising out of the use of TI products in such safety-critical applications.

TI products are neither designed nor intended for use in military/aerospace applications or environments unless the TI products are specifically designated by TI as military-grade or "enhanced plastic." Only products designated by TI as military-grade meet military specifications. Buyers acknowledge and agree that any such use of TI products which TI has not designated as military-grade is solely at the Buyer's risk, and that they are solely responsible for compliance with all legal and regulatory requirements in connection with such use.

TI products are neither designed nor intended for use in automotive applications or environments unless the specific TI products are designated by TI as compliant with ISO/TS 16949 requirements. Buyers acknowledge and agree that, if they use any non-designated products in automotive applications, TI will not be responsible for any failure to meet such requirements.

Following are URLs where you can obtain information on other Texas Instruments products and application solutions:

Products		Applications	
Amplifiers	amplifier.ti.com	Audio	www.ti.com/audio
Data Converters	dataconverter.ti.com	Automotive	www.ti.com/automotive
DSP	dsp.ti.com	Broadband	www.ti.com/broadband
Interface	interface.ti.com	Digital Control	www.ti.com/digitalcontrol
Logic	logic.ti.com	Military	www.ti.com/military
Power Mgmt	power.ti.com	Optical Networking	www.ti.com/opticalnetwork
Microcontrollers	microcontroller.ti.com	Security	www.ti.com/security
RFID	www.ti-rfid.com	Telephony	www.ti.com/telephony
Low Power Wireless	www.ti.com/lpw	Video & Imaging	www.ti.com/video
		Wireless	www.ti.com/wireless

Mailing Address: Texas Instruments, Post Office Box 655303, Dallas, Texas 75265
Copyright © 2007, Texas Instruments Incorporated