



# EFM32 Series 0: Introduction



# EFM32 Series 0 Training

## Topic

EFM32 Intro  
Tools, projects and IDEs  
Intro to EFM32 API  
Interrupts and Energy Modes

Flash Programming and Debug Interface  
Bootloaders

Hardware Design  
Analog Peripherals  
Serial Communication Peripherals

Displays and the External Bus Interface  
DMA  
PRS  
Timers and Counters

Low Energy Sensor Interface (LESENSE)  
Energy Optimization  
Third-party Software and Tools

# EFM32 Intro

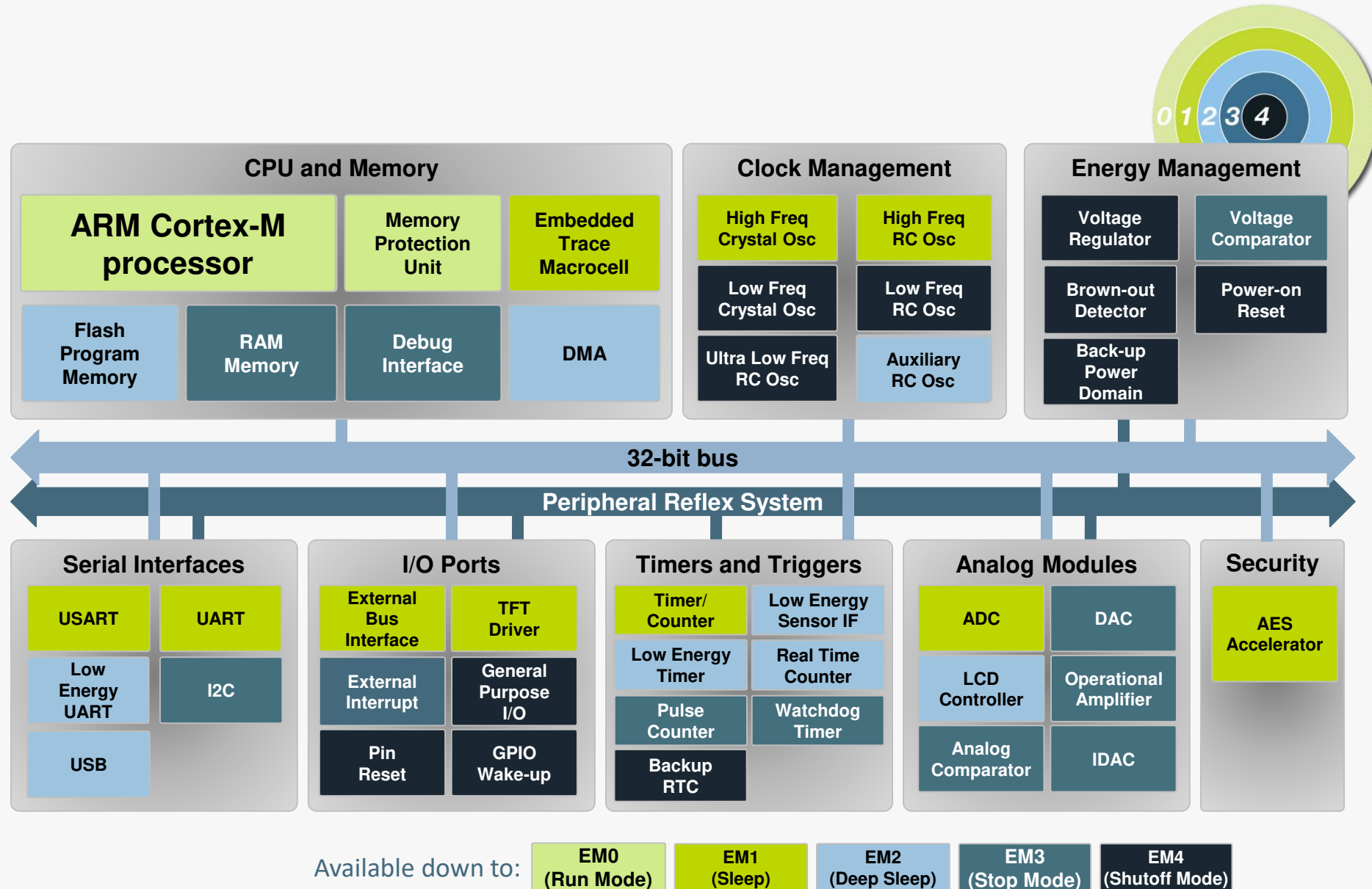

# Clocks and Oscillators

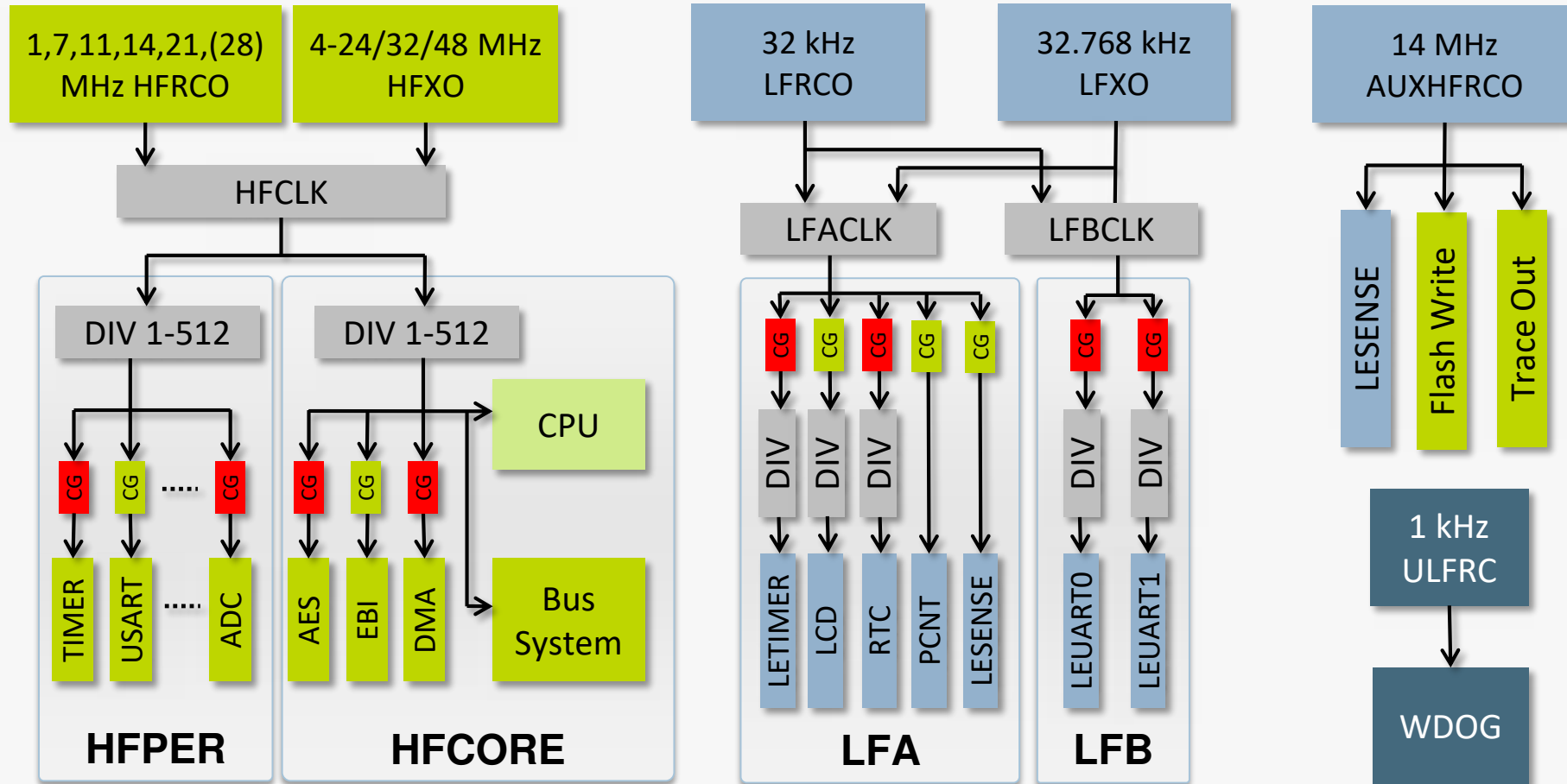

# Current Part Numbers

Software compatible

Pin compatible within each package

Series	Model	Optional Features	QFN24	QFN32	QFN64	QFP48	QFP64	QFP100	BGA48	BGA112	BGA120	
M4	Wonder	USB LCD TFT DSP with FPU			EFM32WG940		EFM32WG942	EFM32WG980		EFM32WG990	EFM32WG995	
					EFM32WG330		EFM32WG332	EFM32WG380		EFM32WG390	EFM32WG395	
					EFM32WG840	Pin compatible	EFM32WG842	EFM32WG880		EFM32WG890	EFM32WG895	
					EFM32WG230		EFM32WG232	EFM32WG280		EFM32WG290	EFM32WG295	
M3	Leopard	USB LCD TFT			EFM32GG940			EFM32GG942	EFM32GG980		EFM32GG990	EFM32GG995
					EFM32GG330			EFM32GG332	EFM32GG380		EFM32GG390	EFM32GG395
					EFM32GG840		EFM32GG842	EFM32GG880		EFM32GG890	EFM32GG895	
					EFM32GG230		EFM32GG232	EFM32GG280		EFM32GG290	EFM32GG295	
M3	Gecko	LCD			EFM32LG940		EFM32LG942	EFM32LG980		EFM32LG990	EFM32LG995	
					EFM32LG330		EFM32LG332	EFM32LG380		EFM32LG390	EFM32LG395	
					EFM32LG840		EFM32LG842	EFM32LG880		EFM32LG890	EFM32LG895	
M3	Tiny	LCD			EFM32LG230		EFM32LG232	EFM32LG280		EFM32LG290	EFM32LG295	
					EFM32G840		EFM32G842	EFM32G880		EFM32G890		
M0+	Zero	LCD			EFM32G210		EFM32G222	EFM32G232		EFM32G290		
					EFM32G200		EFM32G222	EFM32G280		EFM32G290		
M0+	Zero	LCD	EFM32TG110		EFM32TG840	EFM32TG822	EFM32TG842		EFM32TG825			
			EFM32TG108	EFM32TG210	EFM32TG230	EFM32TG222	EFM32TG232		EFM32TG225			
M0+	Zero	LCD	EFM32ZG110									
			EFM32ZG108	EFM32ZG210		EFM32ZG222						



**Up to 32 MHz**  
Flash: 4 - 32  
RAM: 2 - 4



**Up to 32 MHz**  
Flash: 4 - 32  
RAM: 2 - 4



**Up to 32 MHz**  
Flash: 16 - 128  
RAM: 8 - 16



**Up to 48 MHz**  
Flash: 64 - 256  
RAM: 32





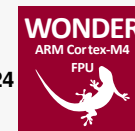



**Up to 48 MHz**  
Flash: 512 - 1024  
RAM: 128



**Up to 48 MHz**  
Flash: 64 - 256  
RAM: 32

LINKS

# Kits

	\$30	\$30	\$30	\$30	\$300	\$349
	Zero Gecko Starter Kit	Gecko Starter Kit	Tiny Gecko Starter Kit	Leopard/Giant/Wonder Gecko Starter Kit	Gecko Development Kit	Leopard/Giant/Wonder Gecko Development Kit
						
Kit Part Number	EFM32ZG-STK3200	EFM32G-G8XX-STK	EFM32TG-STK3300	EFM32LG-STK3600 EFM32GG-STK3700 EFM32WG-STK3800	EFM32G-DK3550	EFM32LG-DK3650 EFM32GG-DK3750 EFM32WG-DK3850
Device	EFM32ZG222F32	EFM32G890F128	EFM32TG840F32	EFM32LG990F256 EFM32WG990F256 EFM32GG990F1024	EFM32G890F128	EFM32LG990F256 EFM32WG990F256 EFM32GG990F1024
Advanced Energy Monitoring	Yes	Yes	Yes	Yes	Yes	Yes
USB J-Link Debugger	Yes	Yes	Yes	Yes	Yes	Yes
Plug-in MCU and prototyping board	-	-	-	-	Yes	Yes
Onboard J-Trace	-	-	-	-	-	Yes
Screen	128x128 pixel MemoryLCD	4x40 segment LCD	8x20 segment LCD	8x20 segment LCD	4x40 segment LCD 320x240 RGB TFT w/touch	320x240 RGB TFT w/touch