

NOTES:

- 1) MATERIAL: GLASS FILLED POLYESTER, UL 94V-0
COLOR: BLACK
- 2) HOUSING TO BE USED WITH TERMINAL
PT. NO. 70021-****.
- 3) SEE CHART FOR CIRCUIT SIZES.
- 4) TO BE USED WITH 70400 SERIES
CONNECTORS (STYLE "G").
- 5) PACKAGE PER PK-70107-100.

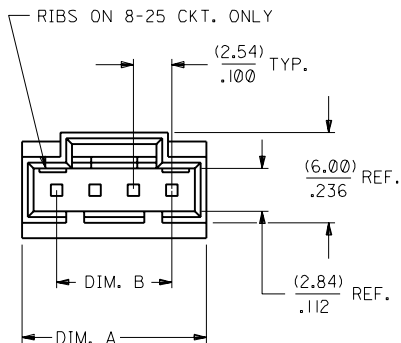

2 CIRCUIT

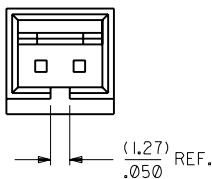

3 CIRCUIT

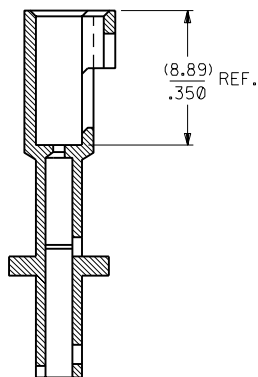
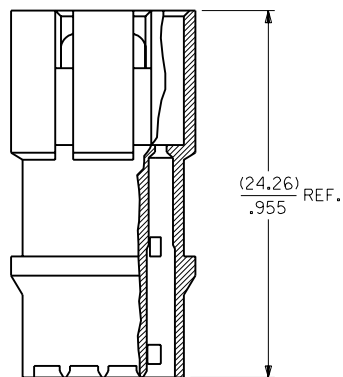
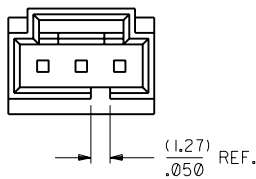

SECTION A-A

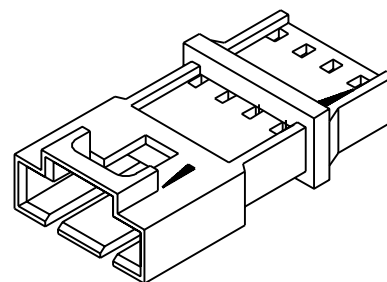
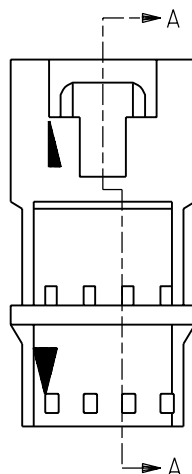

CKT. SIZE	EDP. NO.	ENG. NO.	A	B
2	701-07-0071	70107-0071	(7.11) .280	(2.54) .100
3	701-07-0072	70107-0072	(9.65) .380	(5.08) .200
4	701-07-0073	70107-0073	(12.19) .480	(7.62) .300
5	701-07-0074	70107-0074	(14.73) .580	(10.16) .400
6	701-07-0075	70107-0075	(17.27) .680	(12.70) .500
7	701-07-0076	70107-0076	(19.81) .780	(15.24) .600
8	701-07-0077	70107-0077	(22.35) .880	(17.78) .700
9	701-07-0078	70107-0078	(24.89) .980	(20.32) .800
10	701-07-0079	70107-0079	(27.43) 1.080	(22.86) .900
11	701-07-0080	70107-0080	(29.97) 1.180	(25.40) 1.000
12	701-07-0081	70107-0081	(32.51) 1.280	(27.94) 1.100
13	701-07-0082	70107-0082	(35.05) 1.380	(30.48) 1.200
14	701-07-0083	70107-0083	(37.59) 1.480	(33.02) 1.300
15	701-07-0084	70107-0084	(40.13) 1.580	(35.56) 1.400
16	701-07-0085	70107-0085	(42.67) 1.680	(38.10) 1.500
17	701-07-0086	70107-0086	(45.21) 1.780	(40.64) 1.600
18	701-07-0087	70107-0087	(47.75) 1.880	(43.18) 1.700
19	701-07-0088	70107-0088	(50.29) 1.980	(45.72) 1.800
20	701-07-0089	70107-0089	(52.83) 2.080	(48.26) 1.900
21	701-07-0090	70107-0090	(55.37) 2.180	(50.80) 2.000
22	701-07-0091	70107-0091	(57.91) 2.280	(53.34) 2.100
23	701-07-0092	70107-0092	(60.45) 2.380	(55.88) 2.200
24	701-07-0093	70107-0093	(62.99) 2.480	(58.42) 2.300
25	701-07-0094	70107-0094	(65.53) 2.580	(60.96) 2.400

CHANGED MATERIAL SWITCHED A AND B DIMS PER UDT2002-0007 KSTILES 01/07/17 ADD PKG NOTE PER UDT2000-0468 SCHAFFER 99/12/1 RELEASE FOR PRODUCTION PER ERO #26620 6/3/88 MJM		DIMENSIONS SHOWN (METRIC) INCH UNLESS OTHERWISE SPECIFIED TOLERANCES: ANGULAR ± 1/2° INCH METRIC 3 PLACE ± .010 --- 2 PLACE ± .014 ± 0.25 1 PLACE --- ± 0.35 DRAFT WHERE APPLICABLE MUST REMAIN WITHIN DIMENSIONS DRWG. BY: MJM CHK'D BY: MJM APP'D BY: WAZ SCALE: 4 : 1		MFG, SH, REV. REVISIONS C B C I		TITLE: HOUSING, CONNECTOR (2.54)/.100 GRID VERSION "C" WITH SKIRT MOLEX INCORPORATED SHEET NO. 1 DATE 06/03/88 U.S.A. PART NO. SD-70107-0071-0094 DIV. DA	
--	--	--	--	---	--	--	--