

# HC-M-B24-DOCK-B - Docking frame



1051227

<https://www.phoenixcontact.com/us/products/1051227>

Please be informed that the data shown in this PDF document is generated from our online catalog. Please find the complete data in the user documentation. Our general terms of use for downloads are valid.

Docking frame for 6 modules, floating assembly, rack compensation of  $\pm 2.0$  mm in the x/y-axis



## Product description

Docking frame, floating assembly, rack compensation of  $\pm 2.0$  mm in the x/y axis

## Commercial data

Item number	1051227
Packing unit	1 pc
Minimum order quantity	1 pc
Sales key	BF62
Product key	BF7ACZ
GTIN	4055626673080
Weight per piece (including packing)	137.4 g
Weight per piece (excluding packing)	137.4 g
Customs tariff number	85389099
Country of origin	CN

# HC-M-B24-DOCK-B - Docking frame



1051227

<https://www.phoenixcontact.com/us/products/1051227>

## Technical data

### Product properties

Type	B24
Product type	Docking frame
Application	Modular docking frame
Number of module slots	6
Series	HC-M-B HC-M-02 HC-M-03 HC-M-03/04 HC-M-04 HC-M-05 HC-M-06 HC-M-08 HC-M-08-GBIT HC-M-12 HC-M-17 HC-M-20 HC-M-25 HC-M-DSUB HC-M-EMV HC-M-HV HC-M-HS HC-M-00
Frame type	Docking frames

### Material specifications

Material	die-cast aluminum
----------	-------------------

### Mounting

Mounting type	Direct mounting with flange
Assembly instructions	Optional PE connection possible When using the module carrier frame in metal housings, the connection of the PE conductor must be ensured via the PE connection provided on the module carrier frame or via a special metal PE module

# HC-M-B24-DOCK-B - Docking frame



1051227

<https://www.phoenixcontact.com/us/products/1051227>

## Drawings

Dimensional drawing

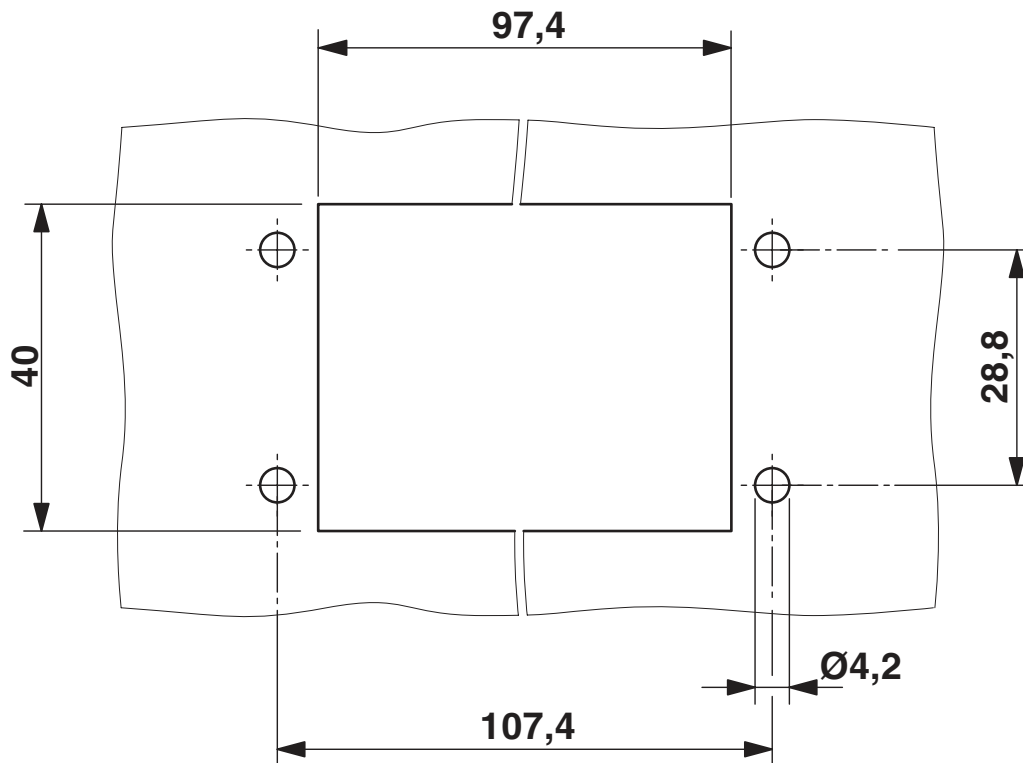

Mounting cutout

Dimensional drawing

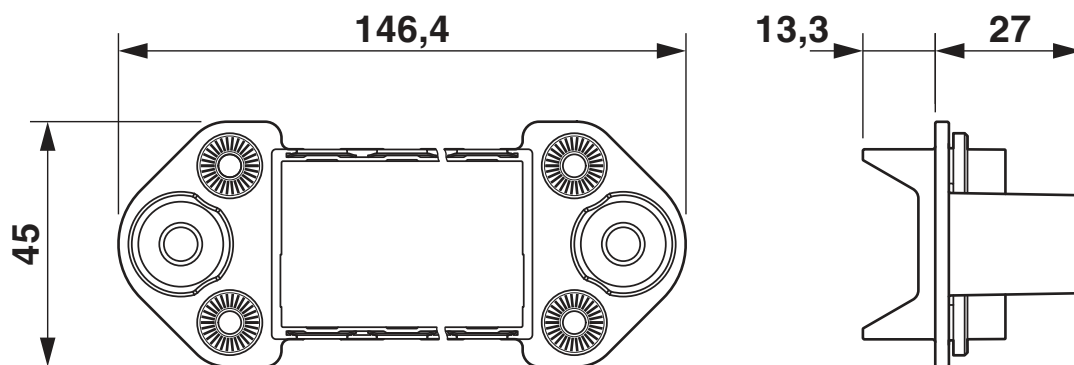

Dimensional drawing

# HC-M-B24-DOCK-B - Docking frame



1051227

<https://www.phoenixcontact.com/us/products/1051227>

## Classifications

### ECLASS

ECLASS-11.0	27440206
ECLASS-12.0	27440206
ECLASS-13.0	27440206

### ETIM

ETIM 8.0	EC002312
----------	----------

### UNSPSC

UNSPSC 21.0	31261500
-------------	----------

# HC-M-B24-DOCK-B - Docking frame



1051227

<https://www.phoenixcontact.com/us/products/1051227>

## Environmental product compliance

China RoHS	Environmentally friendly use period: unlimited = EFUP-e
	No hazardous substances above threshold values

# HC-M-B24-DOCK-B - Docking frame

1051227

<https://www.phoenixcontact.com/us/products/1051227>



## Accessories

### HC-MOD-ANDOCK-USCH - Washer

1587496

<https://www.phoenixcontact.com/us/products/1587496>

Special washer for floating mounting of docking frame



---

Phoenix Contact 2023 © - all rights reserved  
<https://www.phoenixcontact.com>

Phoenix Contact USA  
586 Fulling Mill Road  
Middletown, PA 17057, United States  
(+717) 944-1300  
[info@phoenixcon.com](mailto:info@phoenixcon.com)