

# 4-channel BTL driver for CD players

## BA6896FP

The BA6896FP is a 4-channel BTL driver designed for CD player motor and actuator drives. The internal 5V regulator and standard operational amplifier make this IC suitable for a wide spectrum of applications.

### ●Applications

CD players, CD-ROM drives

### ●Features

- 1) HSOP 28-pin package, for application miniaturization.
- 2) A minimum of attached components.
- 3) Driver gain is adjustable with a single attached resistor.
- 4) Internal 5V regulator. (requires attached PNP transistor)
- 5) Internal standard operational amplifier.
- 6) Internal thermal shutdown function.
- 7) The output current between pins 1 and 2 is mutable with the external mute pin.

### ●Absolute maximum ratings (Ta = 25°C)

Parameter	Symbol	Limits	Unit
Power supply voltage	V <sub>cc</sub>	18	V
Power dissipation	P <sub>d</sub>	1.7*	W
Operating temperature	T <sub>opr</sub>	-35~+85	°C
Storage temperature	T <sub>stg</sub>	-55~+150	°C

\* Reduced by 13.6 mW for each increase in Ta of 1°C over 25°C.  
When mounted on a 50 × 50 × 1 mm paper phenol board.

Operating supply voltage range: 6-14 V (5.5-14V when not using the regulator)

\* Pins 5 and 6 may be left open when the regulator is not used.

## ● Block diagram

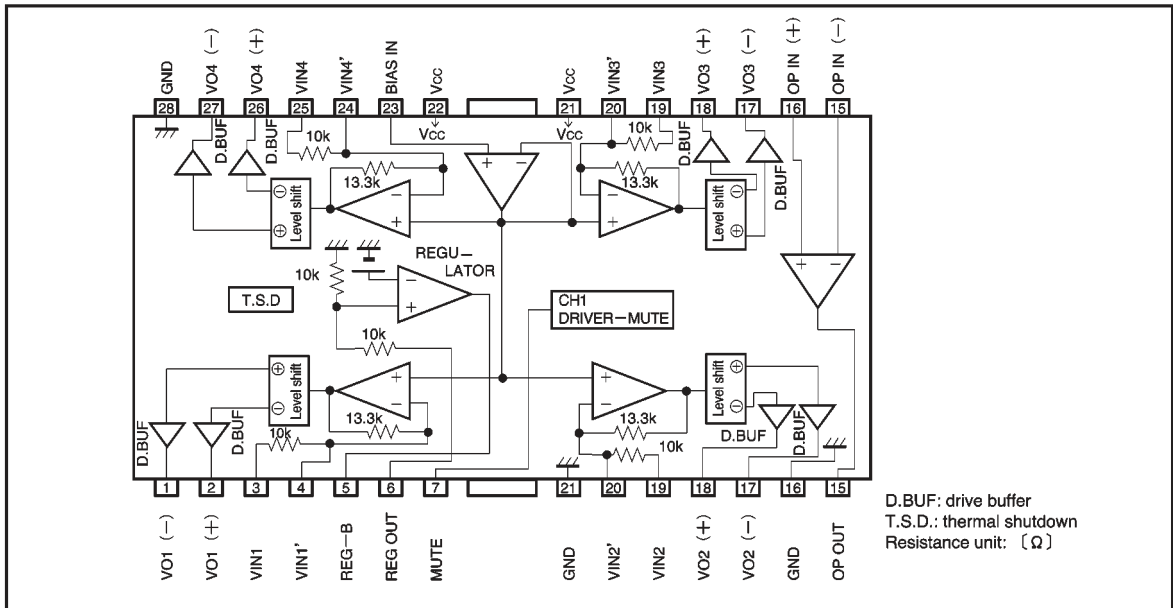

## ● Pin descriptions

Pin No.	Pin name	Function
1	VO1 (-)	Driver channel 1 negative output
2	VO1 (+)	Driver channel 1 positive output
3	VIN1	Driver channel 1 input
4	VIN1'	Input for adjusting driver channel 1 gain
5	REG-B	Connect to base of attached transistor
6	REG OUT	Constant voltage output (connect to collector of attached transistor)
7	MUTE	Mute control
8	GND	Ground
9	VIN2'	Input for adjusting driver channel 2 gain
10	VIN2	Driver channel 2 input
11	VO2 (+)	Driver channel 2 positive output
12	VO2 (-)	Driver channel 2 negative output
13	GND	Substrate ground
14	OP OUT	Operational amplifier output

Pin No.	Pin name	Function
15	OP IN (-)	Operational amplifier negative input
16	OP IN (+)	Operational amplifier positive input
17	VO3 (-)	Driver channel 3 negative output
18	VO3 (+)	Driver channel 3 positive output
19	VIN3	Driver channel 3 input
20	VIN3'	Input for adjusting driver channel 3 gain
21	Vcc	Vcc
22	Vcc	Vcc
23	BIAS IN	Bias amplifier input
24	VIN4'	Input for adjusting driver channel 4 gain
25	VIN4	Driver channel 4 input
26	VO4 (+)	Driver channel 4 positive output
27	VO4 (-)	Driver channel 4 negative output
28	GND	Substrate ground

Note: Positive and negative output of the driver is relative to the polarity of the input pins.

For example, when an input pin goes to the high level, the negative output pin goes to the low level and the positive output pin to the high level.

● Pin equivalent circuit diagrams

Driver input

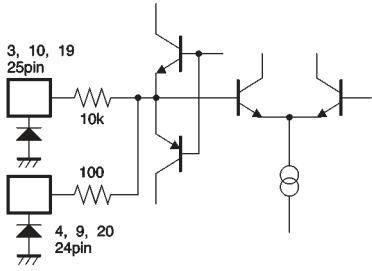

Driver output

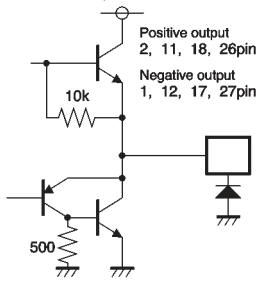

Bias

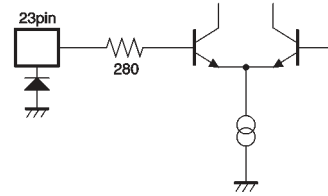

Regulator (Base connection)

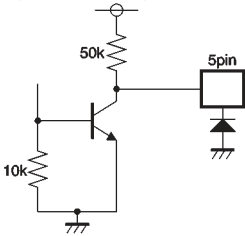

Mute

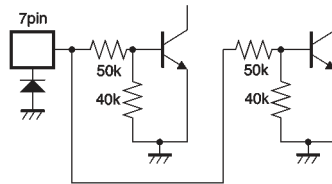

Regulator output

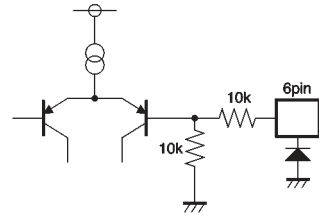

Operational amplifier input

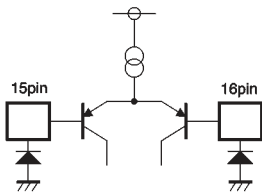

Operational amplifier output

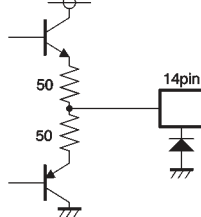

● Electrical characteristics (unless otherwise noted,  $T_a = 25^\circ\text{C}$ ,  $V_{CC} = 8\text{V}$ ,  $f = 1\text{kHz}$ ,  $R_L = 8\Omega$ )

Parameter	Symbol	Min.	Typ.	Max.	Unit	Conditions
Quiescent current dissipation	$I_{CC}$	6.0	10.0	14.0	mA	No load
Output voltage, offset	$V_{OO}$	-40	—	40	mV	
Maximum output amplitude	$V_{OM}$	3.8	4.3	—	V	
Closed loop voltage gain	$G_{VC}$	7.0	8.0	9.0	dB	$V_{IN} = 0.1V_{rms}, 1\text{kHz}$
Ripple rejection	RR	—	60	—	dB	$V_{IN} = 0.1V_{rms}, 100\text{Hz}$
Slew rate	SR	—	2.0	—	V/ $\mu\text{s}$	100 kHz square wave, 3 $V_{P-P}$ output
MUTE ON voltage	$V_{MON}$	2.2	—	—	V	
MUTE OFF voltage	$V_{MOFF}$	—	—	0.4	V	
〈5 V regulator〉						
Output voltage	$V_{REG}$	4.75	5.00	5.25	V	$I_L = 100\text{mA}$
Output load differential	$\Delta V_{RL}$	-50	0	10	mV	$I_L = 0 \sim 200\text{mA}$
Power supply volt. differential	$\Delta V_{VCC}$	-30	0	75	mV	( $V_{CC} = 6 \sim 14\text{V}$ ) $I_L = 100\text{mA}$
〈Operational amplifier〉						
Offset voltage	$V_{OFOP}$	-5	0	5	mV	
Input bias current	$V_{BOP}$	—	—	300	nA	
Output high level voltage	$V_{OHOP}$	6.0	—	—	V	
Output low level voltage	$V_{OLOP}$	—	0.7	1.1	V	
Output drive current (sink)	$I_{SINK}$	10	50	—	mA	50 $\Omega$ at $V_{CC}$
Output drive current (source)	$I_{SOURCE}$	10	40	—	mA	50 $\Omega$ at GND
Open loop voltage gain	$G_{VO}$	—	78	—	dB	$V_{IN} = -75\text{dBV}, 1\text{kHz}$
Slew rate	$SR_{OP}$	—	1	—	V/ $\mu\text{s}$	100 kHz square wave, 4 $V_{P-P}$ output
Ripple rejection ratio	$RR_{OP}$	—	65	—	dB	$V_{IN} = -20\text{dBV}, 100\text{Hz}$
Common mode rejection ratio	CMRR	—	84	—	dB	$V_{IN} = -20\text{dBV}, 1\text{kHz}$

© Not designed for radiation resistance.



● Circuit operation

(1) Driver

Inputs to the IC are the focus tracking error signal from the servo preamplifier and the control signal from the motor. The input signals, which normally center on 2.5V, are V / I converted by the preamplifier, generating a current corresponding to the input voltage. This current is

passed through a resistor and into the internal reference voltage component, the preamplifier output being a signal centering on the internal reference voltage. Two systems (positive phase and negative phase) are created during V / I conversion, generating BTL output via the driver buffer.

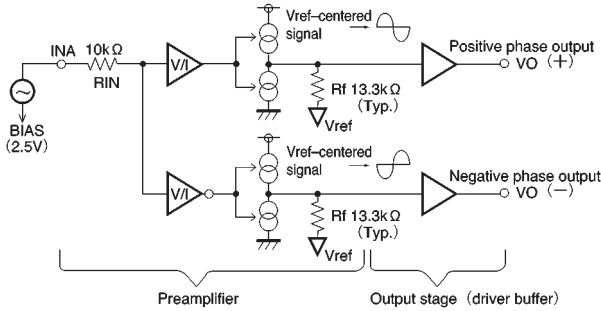

Fig.2

(2) Regulator

This is a typical series regulator that generates a reference voltage internally. A PNP low saturation transistor must be connected.

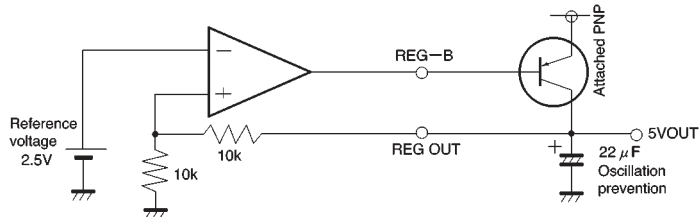

Fig.3

(3) Operational amplifier

A standard 4558 type.

● Application example

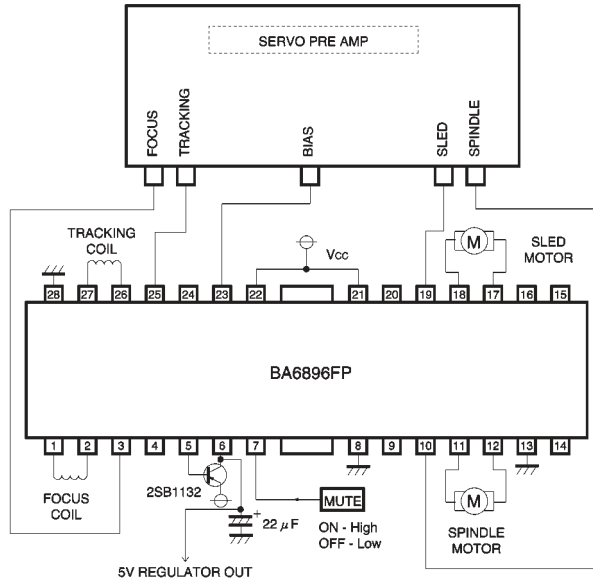

Fig.4

● Operation notes

- (1) The BA6896FP has an internal thermal shutdown circuit. Output current is muted when the chip temperature exceeds 175°C (typically).
- (2) The output current can be muted by raising the mute pin (pin 7) voltage above 2.2V. Pin 7 should be open or pulled up above 0.4V during normal operation.
- (3) Muting also occurs when the bias pin (23 pin) drops below 1.4V (typically). Pin 23 should stay above 1.6V during normal operation.
- (4) The internal circuits turn off when the supply voltage drops below 4.5V (typically) and start up again when the supply voltage rises above 4.7V (typically).

- (5) Muting occurs during thermal shutdown, mute-on operations or a drop in the bias pin voltage or supply voltage. In each case, only the drivers are muted. During muting, the output pins remain at the internal bias voltage, roughly  $(V_{CC} - V_F) / 2$ .
- (6) Attach a bypass capacitor (roughly 0.1μF) to the power supply, at the base of the IC.
- (7) The radiating fin is connected to the package's internal GND, but should also be connected to an external ground.
- (8) The capacitor between regulator output (pin 6) and GND also serves to prevent oscillation of the IC, so select one with good temperature characteristics.

● Thermal derating curve

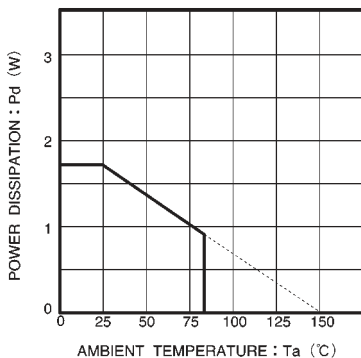

When mounted on a 50 × 50 × 1 mm paper phenol board.

Fig. 5

● Electrical characteristic curves

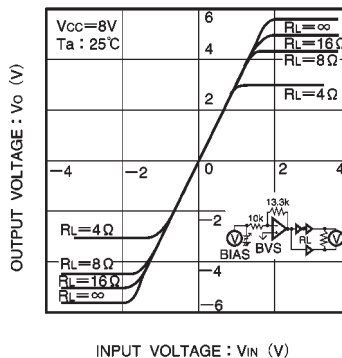

Fig. 6 Driver I / O characteristics (variable load)

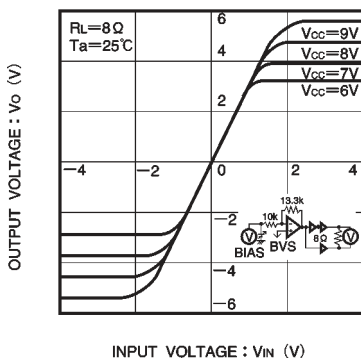

Fig. 7 Driver I / O characteristics (variable Vcc)

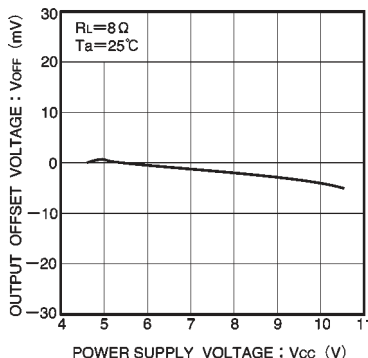

Fig. 8 Power supply voltage vs. output voltage (offset)

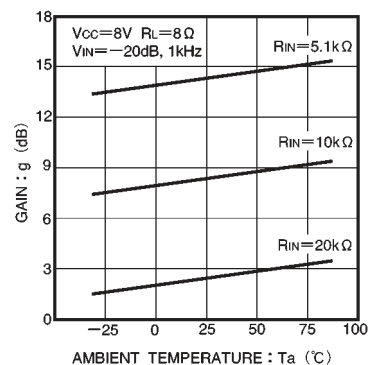

Fig. 9 Driver gain vs. temperature ( $R_{IN}$  connected via gain adjustment pin)



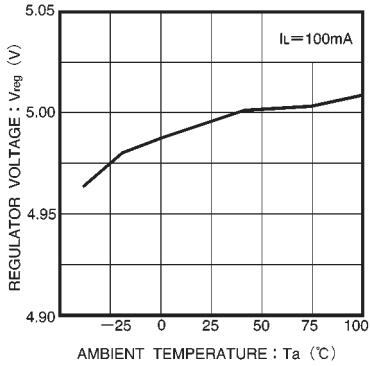

Fig. 10 Regulator voltage vs. temperature

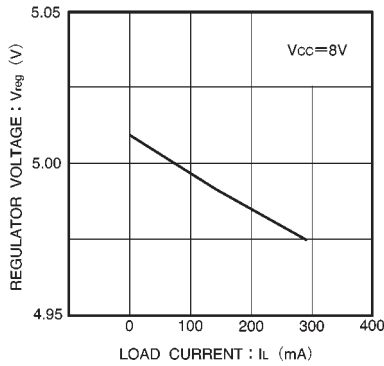

Fig. 11 Load current vs. regulator voltage

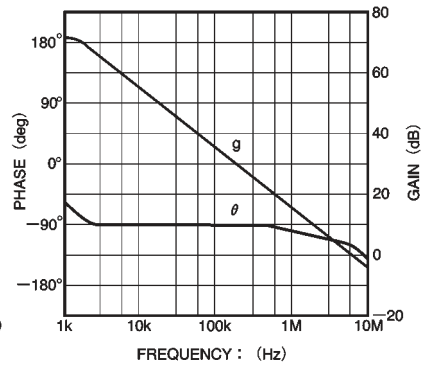

Fig. 12 Operational amplifier vs. open loop

● External dimensions (Units: mm)

